

**P-channel enhancement mode
MOS transistor**

BSH201

FEATURES

- Low threshold voltage
- Fast switching
- Logic level compatible
- Subminiature surface mount package

SYMBOL

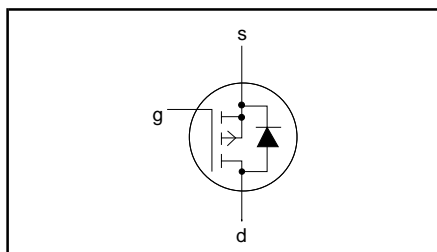

QUICK REFERENCE DATA

$V_{DS} = -60\text{ V}$
$I_D = -0.3\text{ A}$
$R_{DS(ON)} \leq 2.5\ \Omega\ (V_{GS} = -10\text{ V})$

GENERAL DESCRIPTION

P-channel, enhancement mode, logic level, field-effect power transistor. This device has low threshold voltage and extremely fast switching making it ideal for battery powered applications and high speed digital interfacing.

The BSH201 is supplied in the SOT23 subminiature surface mounting package.

PINNING

PIN	DESCRIPTION
1	gate
2	source
3	drain

SOT23

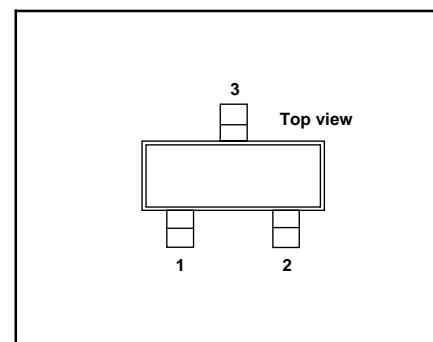

LIMITING VALUES

Limiting values in accordance with the Absolute Maximum System (IEC 134)

SYMBOL	PARAMETER	CONDITIONS	MIN.	MAX.	UNIT
V_{DS}	Drain-source voltage		-	-60	V
V_{DGR}	Drain-gate voltage	$R_{GS} = 20\text{ k}\Omega$	-	-60	V
V_{GS}	Gate-source voltage		-	± 20	V
I_D	Drain current (DC)	$T_a = 25\text{ }^\circ\text{C}$	-	-0.3	A
		$T_a = 100\text{ }^\circ\text{C}$	-	-0.19	A
I_{DM}	Drain current (pulse peak value)	$T_a = 25\text{ }^\circ\text{C}$	-	-1.2	A
P_{tot}	Total power dissipation	$T_a = 25\text{ }^\circ\text{C}$	-	0.417	W
		$T_a = 100\text{ }^\circ\text{C}$	-	0.17	W
T_{stg}, T_j	Storage & operating temperature		- 55	150	$^\circ\text{C}$

THERMAL RESISTANCES

SYMBOL	PARAMETER	CONDITIONS	TYP.	MAX.	UNIT
$R_{th\ j-a}$	Thermal resistance junction to ambient	FR4 board, minimum footprint	300	-	K/W

P-channel enhancement mode MOS transistor

BSH201

ELECTRICAL CHARACTERISTICS

$T_j = 25^\circ\text{C}$ unless otherwise specified

SYMBOL	PARAMETER	CONDITIONS	MIN.	TYP.	MAX.	UNIT
$V_{(BR)DSS}$	Drain-source breakdown voltage	$V_{GS} = 0\text{ V}; I_D = -10\ \mu\text{A}$	-60	-	-	V
$V_{GS(TO)}$	Gate threshold voltage	$V_{DS} = V_{GS}; I_D = -1\ \text{mA}$	-1	-1.9	-	V
		$T_j = 150^\circ\text{C}$	-0.4	-	-	V
$R_{DS(ON)}$	Drain-source on-state resistance	$V_{GS} = -10\text{ V}; I_D = -160\ \text{mA}$	-	2.1	2.5	Ω
		$V_{GS} = -4.5\text{ V}; I_D = -80\ \text{mA}$	-	2.7	3.75	Ω
		$V_{GS} = -10\text{ V}; I_D = -160\ \text{mA}; T_j = 150^\circ\text{C}$	-	3.6	4.25	Ω
g_{fs}	Forward transconductance	$V_{DS} = -48\text{ V}; I_D = -160\ \text{mA}$	0.1	0.35	-	S
I_{GSS}	Gate source leakage current	$V_{GS} = \pm 20\text{ V}; V_{DS} = 0\text{ V}$	-	± 10	± 100	nA
I_{DSS}	Zero gate voltage drain current	$V_{DS} = -48\text{ V}; V_{GS} = 0\text{ V};$ $T_j = 150^\circ\text{C}$	-	-50	-100	nA
			-	-1.3	-10	μA
$Q_{g(tot)}$	Total gate charge	$I_D = -0.5\ \text{A}; V_{DD} = -10\text{ V}; V_{GS} = -10\text{ V}$	-	3	-	nC
Q_{gs}	Gate-source charge		-	0.5	-	nC
Q_{gd}	Gate-drain (Miller) charge		-	0.4	-	nC
$t_{d\ on}$	Turn-on delay time	$V_{DD} = -10\text{ V}; I_D = -0.5\ \text{A};$	-	2	-	ns
t_r	Turn-on rise time	$V_{GS} = -10\text{ V}; R_G = 6\ \Omega$	-	4.5	-	ns
$t_{d\ off}$	Turn-off delay time	Resistive load	-	45	-	ns
t_f	Turn-off fall time		-	20	-	ns
C_{iss}	Input capacitance	$V_{GS} = 0\text{ V}; V_{DS} = -48\text{ V}; f = 1\ \text{MHz}$	-	70	-	pF
C_{oss}	Output capacitance		-	15	-	pF
C_{rss}	Feedback capacitance		-	5	-	pF

REVERSE DIODE LIMITING VALUES AND CHARACTERISTICS

$T_j = 25^\circ\text{C}$ unless otherwise specified

SYMBOL	PARAMETER	CONDITIONS	MIN.	TYP.	MAX.	UNIT
I_{DR}	Continuous reverse drain current	$T_a = 25^\circ\text{C}$	-	-	-0.3	A
I_{DRM}	Pulsed reverse drain current		-	-	-1.2	A
V_{SD}	Diode forward voltage	$I_F = -0.38\ \text{A}; V_{GS} = 0\text{ V}$	-	-0.97	-1.3	V
t_{rr}	Reverse recovery time	$I_F = -0.25\ \text{A}; -di_F/dt = 100\ \text{A}/\mu\text{s};$	-	38	-	ns
Q_{rr}	Reverse recovery charge	$V_{GS} = 0\text{ V}; V_R = -48\text{ V}$	-	58	-	nC

P-channel enhancement mode
MOS transistor

BSH201

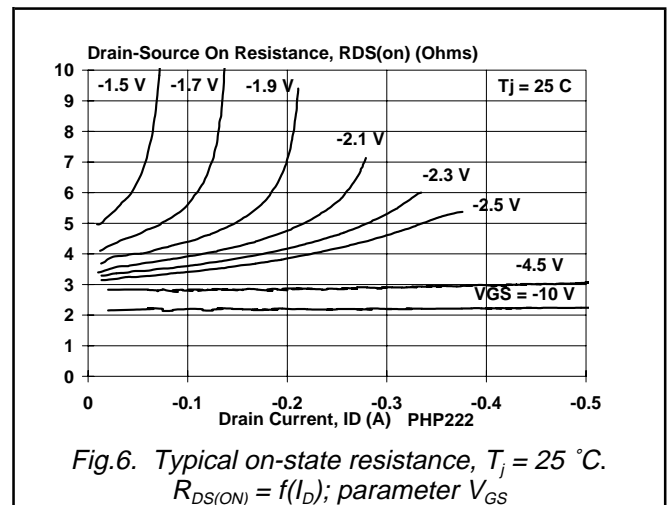
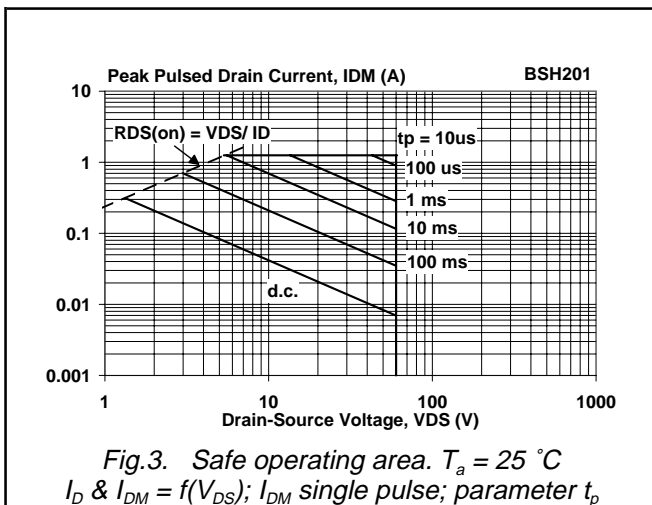
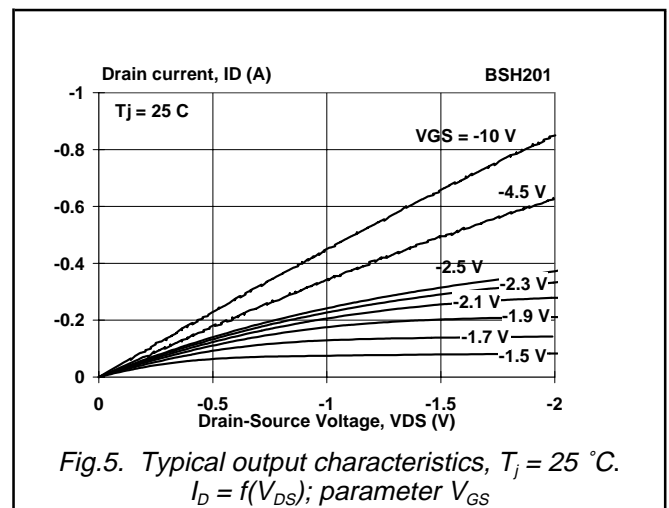
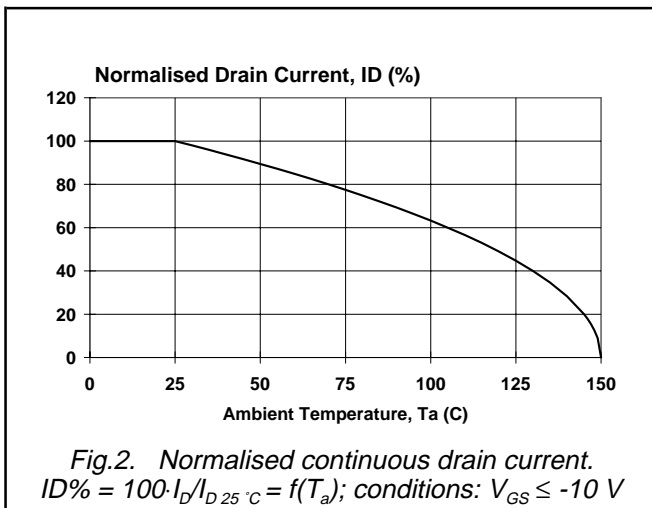
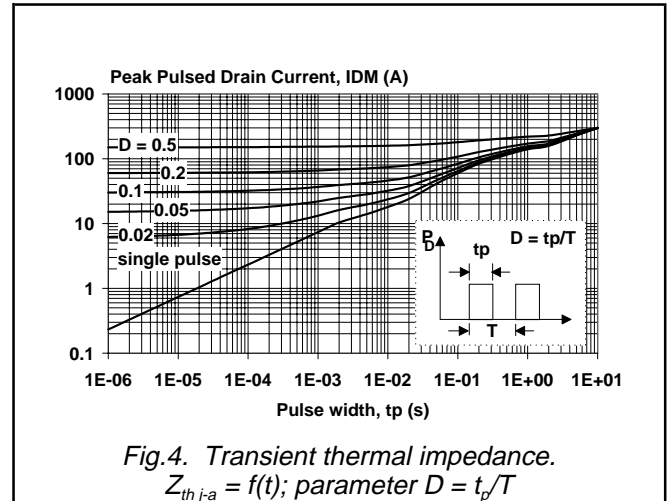

P-channel enhancement mode MOS transistor

BSH201

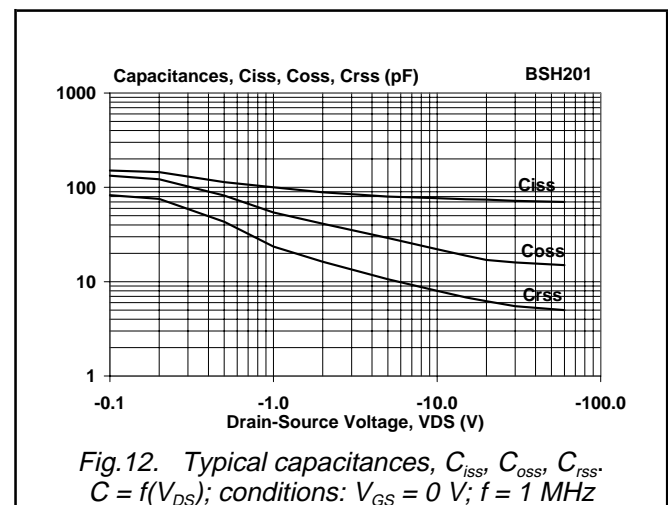
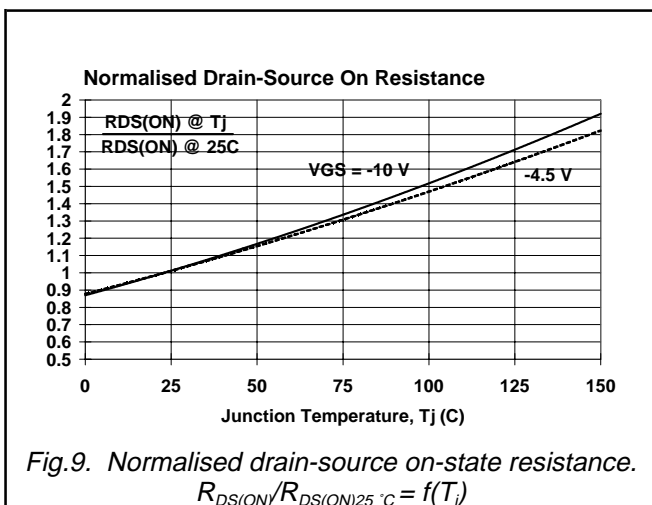
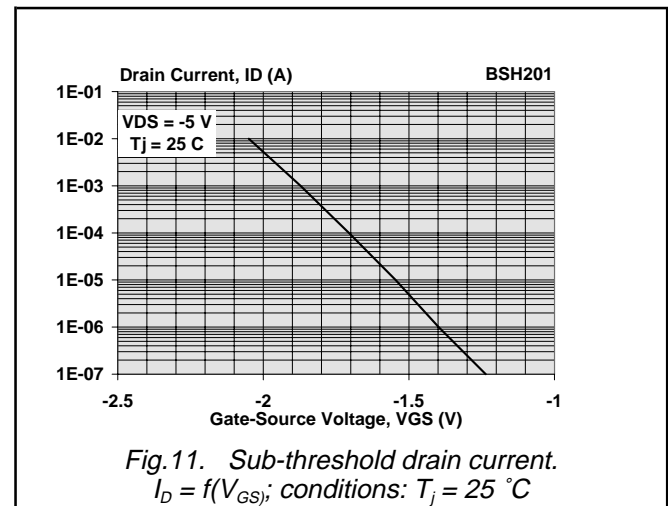
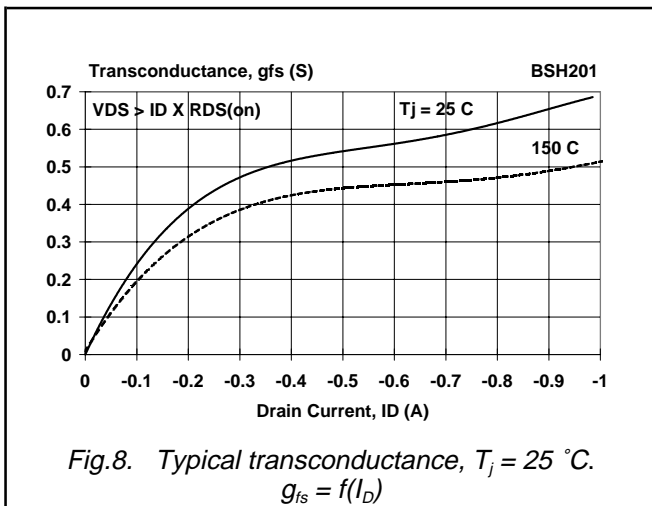
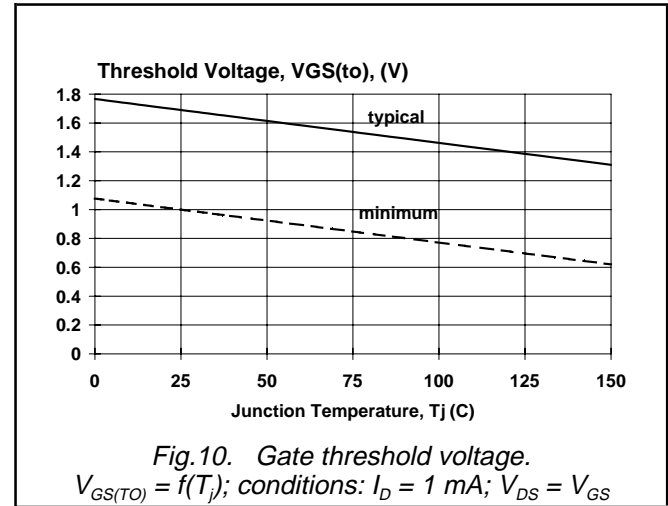
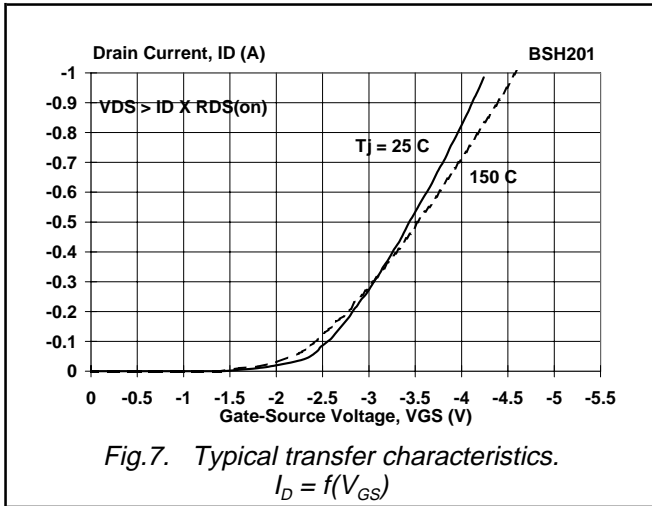

P-channel enhancement mode
MOS transistor

BSH201

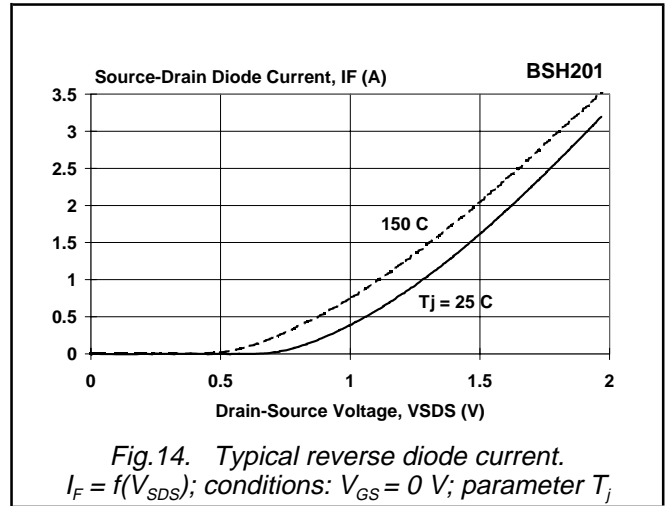
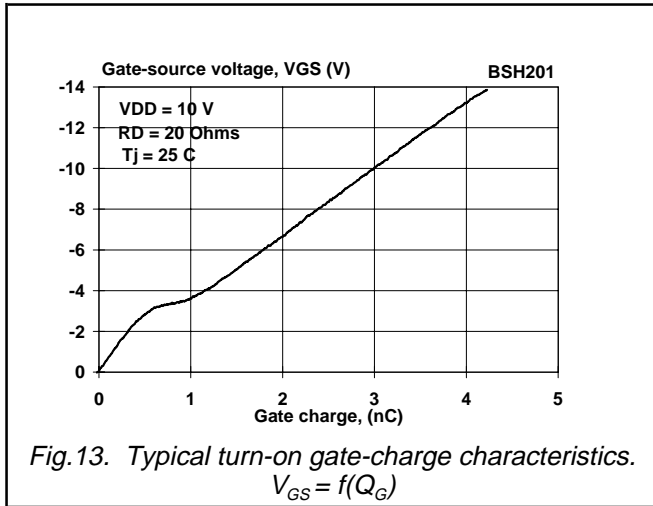

P-channel enhancement mode
MOS transistor

BSH201

MECHANICAL DATA



Fig.15. SOT23 surface mounting package.

Notes

1. This product is supplied in anti-static packaging. The gate-source input must be protected against static discharge during transport or handling.
2. Refer to SMD Footprint Design and Soldering Guidelines, Data Handbook SC18.
3. Epoxy meets UL94 V0 at 1/8".