

RPR-220

Reflective photosensor (photoreflexor)

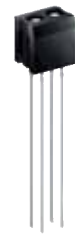

Absolute maximum ratings (Ta=25°C)

Parameter	Symbol	Limits	Unit
Input (LED)	Forward current	I _F	50 mA
	Reverse voltage	V _R	5 V
	Power dissipation	P _D	80 mW
Output (photo-transistor)	Collector-emitter voltage	V _{CEO}	30 V
	Emitter-collector voltage	V _{ECO}	4.5 V
	Collector current	I _C	30 mA
	Collector power dissipation	P _C	80 mW
Operating temperature	T _{opr}	-25 to +85	°C
Storage temperature	T _{stg}	-30 to +85	°C

Applications

- Compact disc players
- Copiers
- Game machines
- Office automation equipment

Features

- 1) A plastic lens is used for high sensitivity.
- 2) A built-in visible light filter minimizes the influence of stray light.
- 3) Lightweight and compact.

Electrical and optical characteristics (Ta=25°C)

Parameter	Symbol	Min.	Typ.	Max.	Unit	Conditions	
Input characteristics	Forward voltage	V _F	1.34	1.6	V	I _F =50mA	
	Reverse current	I _R	-	10	μA	V _R =5V	
Output characteristics	Dark current	I _{CEO}	-	0.5	μA	V _{CE} =10V	
	Peak sensitivity wavelength	λ _P	800	-	nm	-	
Transfer characteristics	Collector current	I _C	0.08	0.3	0.8	mA	V _{CE} =2V, I _F =10mA
	Collector-emitter saturation voltage	V _{CE(sat)}	-	0.1	0.3	V	I _F =20mA, I _C =0.1mA
	Response time	t _r ·t _f	-	10	-	μs	V _{CE} =5V, I _F =20mA, R _L =100Ω
Infrared light emitting diode	Cut-off frequency	f _c	1	-	MHz	I _F =50mA * Non-coherent Infrared light emitting diode used.	
	Peak light emitting wavelength	λ _P	940	-	nm	-	
Photo transistor	Response time	t _r ·t _f	10	-	μs	V _{CC} =5V, I _C =1mA, R _L =100Ω * This product is not designed to be protected against electromagnetic wave.	
	Maximum sensitivity wavelength	λ _P	800	-	nm	-	

* Reflector object : Standard white paper. (Reflection ratio = 90%)

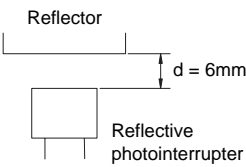

Electrical and optical characteristics curves

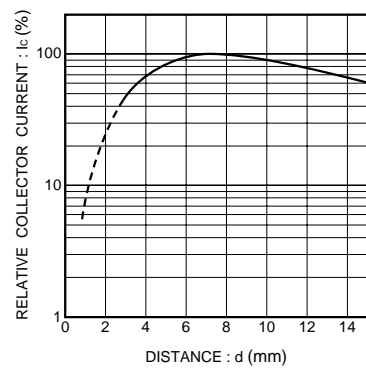

Fig.1 Relative output vs. distance

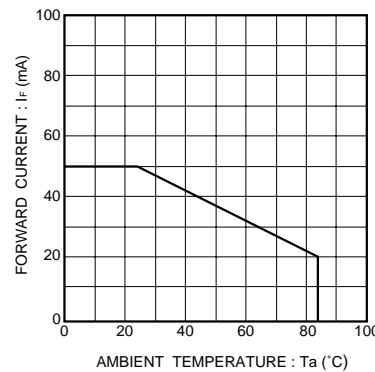

Fig.2 Forward current vs. ambient temperature

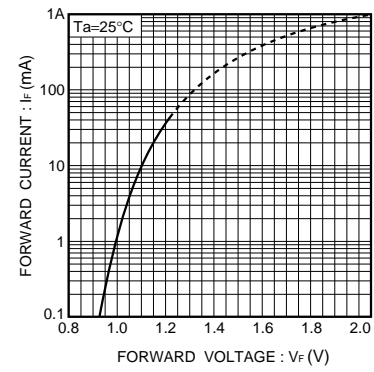

Fig.3 Forward current vs. forward voltage

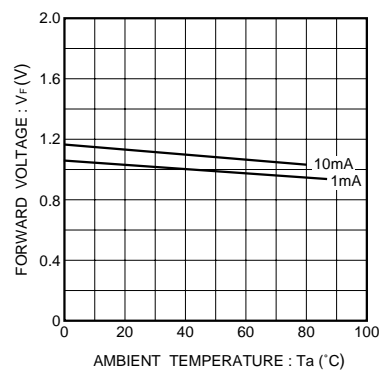

Fig.4 Forward voltage vs. ambient temperature

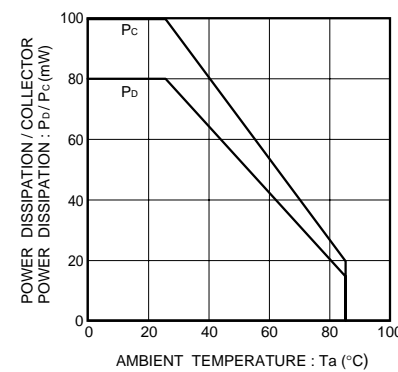

Fig.5 Power dissipation / collector power dissipation vs. ambient temperature

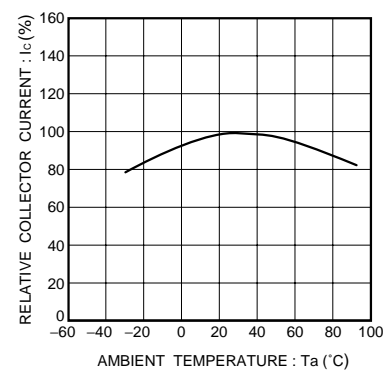

Fig.6 Relative output vs. ambient temperature

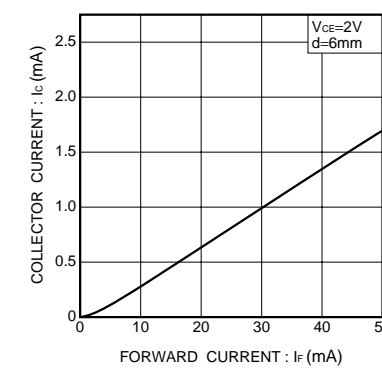

Fig.7 Collector current vs. forward current

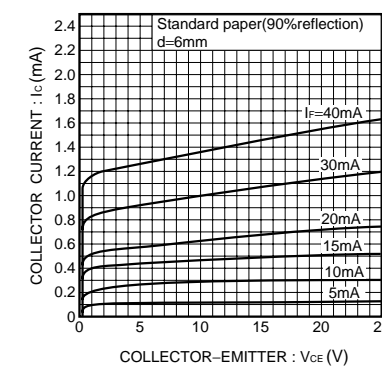

Fig.8 Output characteristics

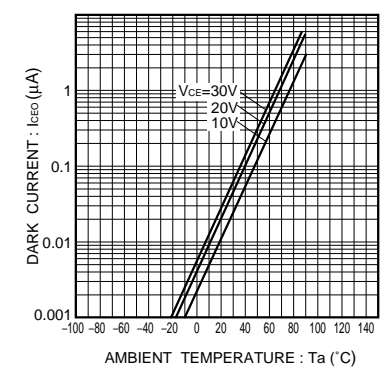
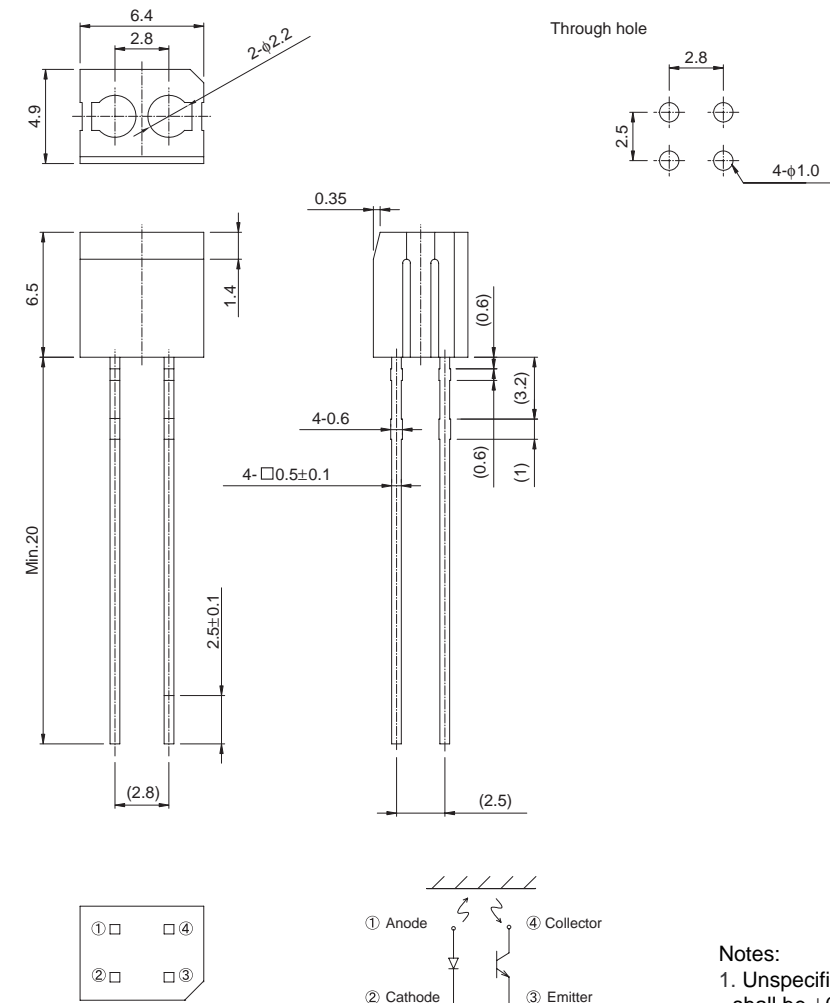

Fig.9 Dark current vs. ambient temperature

External dimensions (Unit : mm)



Notes:

1. Unspecified tolerance shall be ±0.2.
2. Dimension in parenthesis show for reference.