



### FEATURES

- High Efficiency: Up to 96%
- 1.5MHz Constant Frequency Operation
- 1.3A Output Current
- No Schottky Diode Required
- 2.3V to 6V Input Voltage Range
- Output Voltage as Low as 0.6V
- PFM Mode for High Efficiency in Light Load
- 100% Duty Cycle in Dropout Operation
- Low Quiescent Current: 35 $\mu$ A
- Slope Compensated Current Mode Control for Excellent Line and Load Transient Response
- Short Circuit Protection
- Thermal Fault Protection
- Inrush Current Limit and Soft Start
- <1 $\mu$ A Shutdown Current
- SOT23-5 package

### APPLICATIONS

- Cellular and Smart Phones
- Wireless and DSL Modems
- PDAs
- Portable Instruments
- Digital Still and Video Cameras
- Set Top Box

### GENERAL DESCRIPTION

The MT3410L is high-efficiency, high frequency synchronous step-down DC-DC regulator ICs capable of delivering up to 1.3A output currents. The MT3410L can operate over a wide input voltage range from 2.3V to 6V and integrates main switch and synchronous switch with very low  $R_{DS(ON)}$  to minimize the conduction loss.

It is ideal for powering portable equipment that runs from a single cell Lithium-Ion(Li+) battery. The output voltage can be regulated as low as 0.6V. The MT3410L can also run at 100% duty cycle for low dropout operation, extending battery life in portable system. This device offers two operation modes, PWM mode and PFM mode switching control, which allows a high efficiency over the wide range of the load.

The MT3410L is offered in a low profile 5-pin SOT package, and is available in an adjustable version.

### TYPICAL APPLICATION

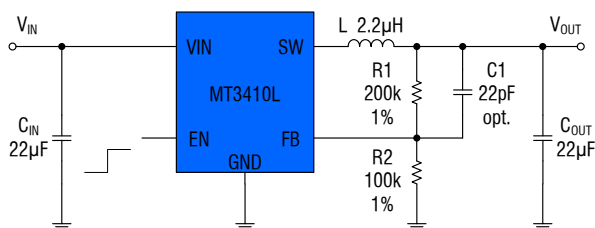
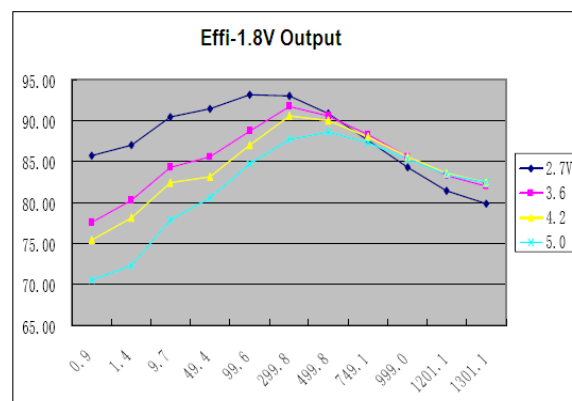

Figure 1. Basic Application Circuit



## ABSOLUTE MAXIMUM RATINGS (Note 1)

Input Supply Voltage.....	-0.3V to 6.5V	Junction Temperature(Note2).....	150°C
EN,FB Voltages.....	-0.3V to (V <sub>IN</sub> + 0.3V)	Operating Temperature Range.....	-40°C to 85°C
SW Voltage.....	-0.3V to (V <sub>IN</sub> + 0.3V)	Lead Temperature(Soldering,10s).....	300°C
Power Dissipation.....	0.4W	Storage Temperature Range.....	-65°C to 150°C
Thermal Resistance $\theta_{JC}$ .....	130°C/W	ESD HBM(Human Body Mode).....	2kV
Thermal Resistance $\theta_{JA}$ .....	250°C/W	ESD MM(Machine Mode).....	200V

## PACKAGE/ORDER INFORMATION

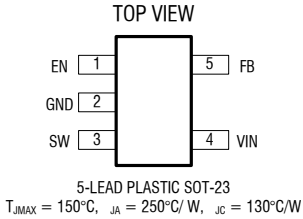
	Order Part Number	Package	Top Marking
	MT3410L	SOT23-5	AS11DW

## PIN DESCRIPTION

Pin Name	Pin Number	Description
EN	1	Chip Enable Pin. Drive EN above 1.5V to turn on the part. Drive EN below 0.3V to turn it off. Do not leave EN floating.
GND	2	Analog ground pin.
SW	3	Power Switch Output. It is the switch node connection to Inductor. This pin connects to the drains of the internal P-ch and N-ch MOSFET switches.
VIN	4	Power Supply Input. Must be closely decoupled to GND with a 10 $\mu$ F or greater ceramic capacitor.
FB	5	Output Voltage Feedback Pin. An internal resistive divider divides the output voltage down for comparison to the internal reference voltage.

## ELECTRICAL CHARACTERISTICS (Note 3)

( $V_{IN}=V_{EN}=3.6V$ ,  $V_{OUT}=1.8V$ ,  $T_A = 25^{\circ}C$ , unless otherwise noted.)

PARAMETER	CONDITIONS	MIN	TYP	MAX	UNIT
Input Voltage Range		2.3		6	V
UVLO Threshold		1.7	1.9	2.1	V
Input DC Supply Current	(Note 4)				$\mu A$
PWM Mode	$V_{OUT} = 90\%$ , $I_{LOAD} = 0mA$		140	300	$\mu A$
PFM Mode	$V_{OUT} = 105\%$ , $I_{LOAD} = 0mA$		35	70	$\mu A$
Shutdown Mode	$V_{EN} = 0V$ , $V_{IN} = 4.2V$		0.1	1.0	$\mu A$
Regulated Feedback Voltage $V_{FB}$	$T_A = 25^{\circ}C$	0.588	0.600	0.612	V
	$T_A = 0^{\circ}C$ $T_A = 85^{\circ}C$	0.586	0.600	0.613	V
	$T_A = -40^{\circ}C$ $T_A = 85^{\circ}C$	0.585	0.600	0.615	V
Reference Voltage Line Regulation	$V_{IN} = 2.5V$ to $6V$		0.04	0.40	%/V
Output Voltage Line Regulation	$V_{IN} = 2.5V$ to $6V$		0.04	0.40	%
Output Voltage Load Regulation			0.5		%
Oscillation Frequency	$V_{OUT} = 100\%$		1.5		MHz
	$V_{OUT} = 0V$		300		kHz
On Resistance of PMOS	$I_{SW} = 100mA$		130	200	m $\Omega$
On Resistance of NMOS	$I_{SW} = -100mA$		100	200	m $\Omega$
Peak Current Limit	$V_{IN} = 3V$ , $V_{OUT} = 90\%$		2		A
EN Threshold		0.30	1.0	1.50	V
EN Leakage Current			$\pm 0.01$	$\pm 1.0$	$\mu A$
SW Leakage Current	$V_{EN} = 0V$ , $V_{IN} = V_{SW} = 5V$		$\pm 0.01$	$\pm 1.0$	$\mu A$

**Note 1:** Absolute Maximum Ratings are those values beyond which the life of a device may be impaired.

**Note 2:**  $T_J$  is calculated from the ambient temperature  $T_A$  and power dissipation  $P_D$  according to the following formula:  $T_J = T_A + (P_D) \times (250^{\circ}C/W)$ .

**Note 3:** 100% production test at  $+25^{\circ}C$ . Specifications over the temperature range are guaranteed by design and characterization.

**Note 4:** Dynamic supply current is higher due to the gate charge being delivered at the switching frequency.

## TYPICAL PERFORMANCE CHARACTERISTICS

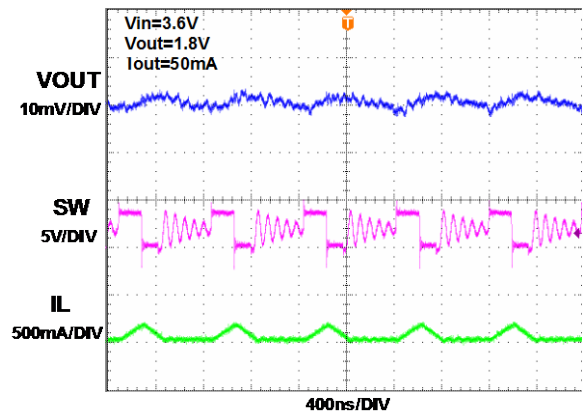
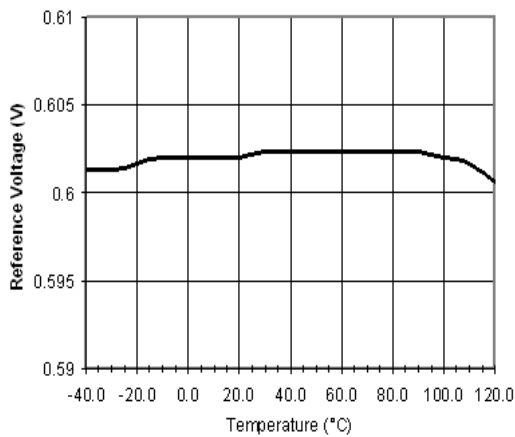
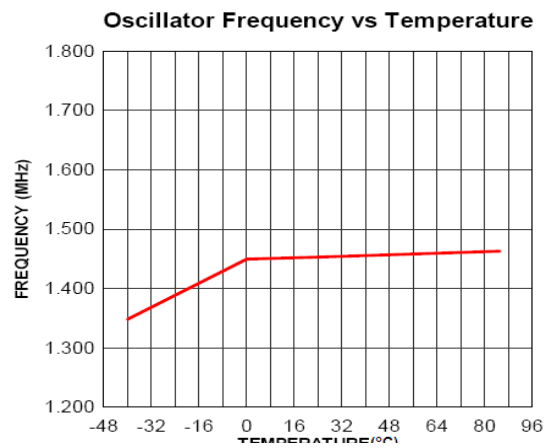
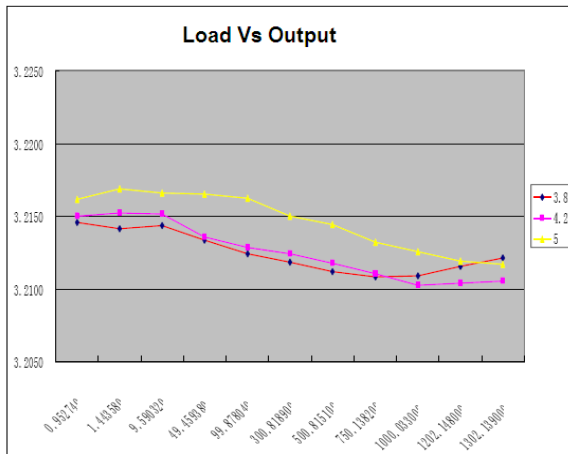
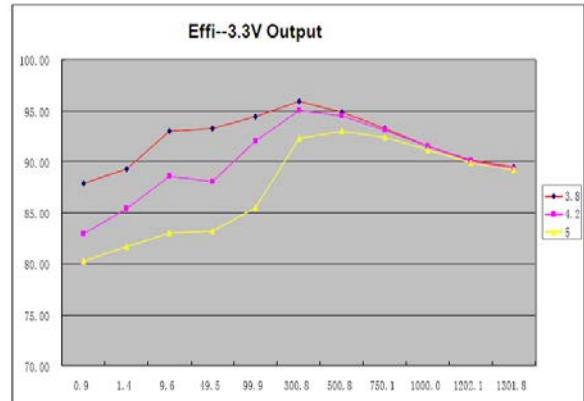
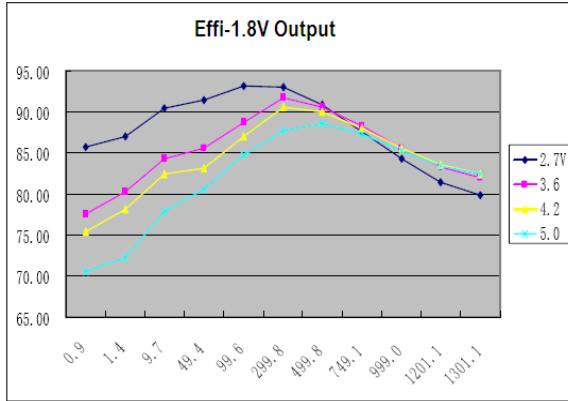

## FUNCTIONAL BLOCK DIAGRAM

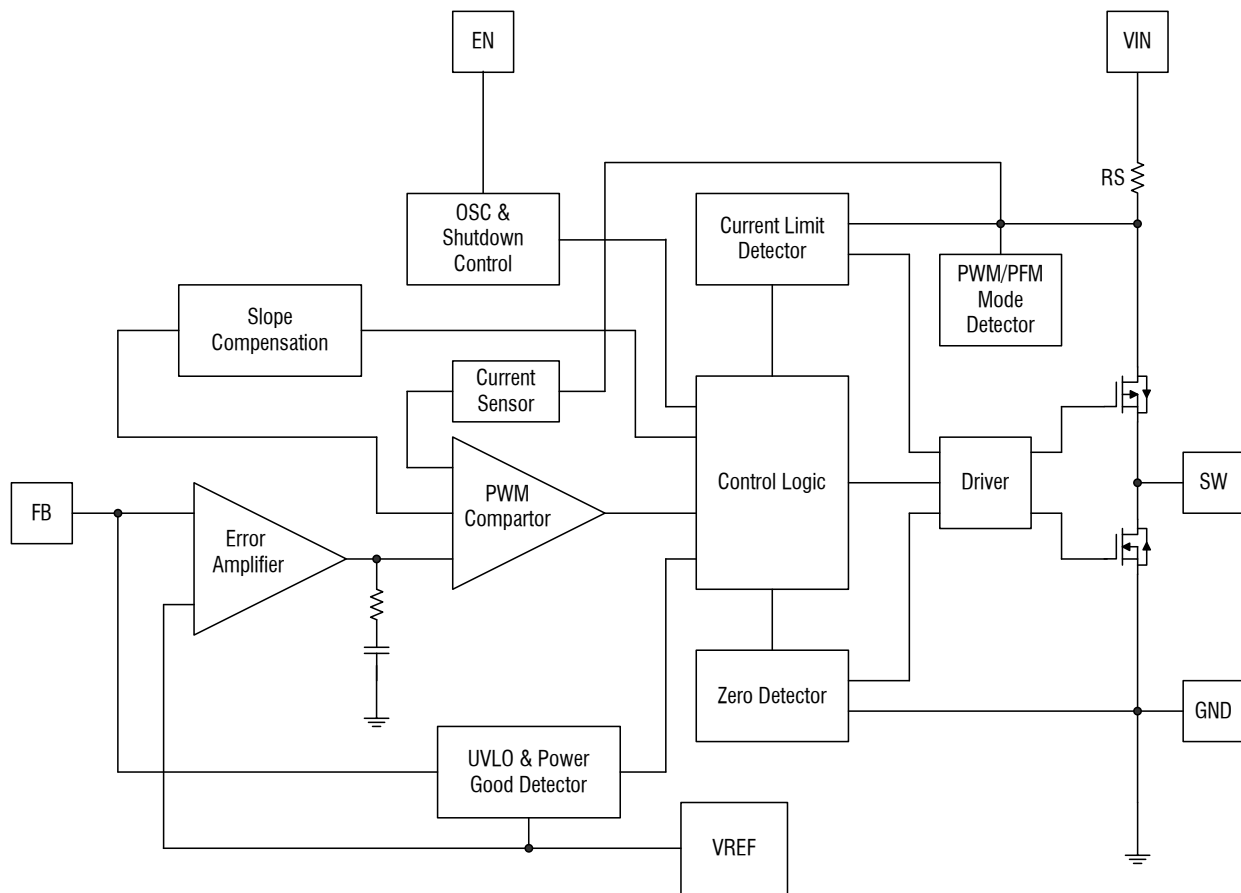

Figure 2. MT3410L Block Diagram

## FUNCTIONAL DESCRIPTION

MT3410L is a synchronous buck regulator IC that integrates the PWM/PFM control, high-side and low-side MOSFETs on the same die to minimize the switching transition loss and conduction loss. With ultra low  $R_{DS(ON)}$  power switches and proprietary PWM control, this regulator IC can achieve the highest efficiency and the highest switch frequency simultaneously to minimize the external inductor and capacitor size, and thus achieving the minimum solution footprint. The MT3410L requires only three external power components ( $C_{IN}$ ,  $C_{OUT}$  and L). The

adjustable version can be programmed with external feedback to any voltage, ranging from 0.6V to the input voltage. At dropout operation, the converter duty cycle increases to 100% and the output voltage tracks the input voltage minus the  $R_{DS(ON)}$  drop of the high-side MOSFET. The internal error amplifier and compensation provides excellent transient response, load and line regulation. Soft start function prevents input inrush current and output overshoot during start up.

## APPLICATIONS INFORMATION

### Setting the Output Voltage

The internal reference voltage  $V_{REF}$  is 0.6V (typical), the output voltage is set by a resistive divider according to the following formula:

$$V_{OUT} = 0.6 \times \left( 1 + \frac{R1}{R2} \right)$$

The external resistive divider is connected to the output, allowing remote voltage sensing as shown in Figure 1.

### Inductor Selection

For most designs, the MT3410L operates with inductors of  $1\mu\text{H}$  to  $4.7\mu\text{H}$ . Low inductance values are physically smaller but require faster switching, which results in some efficiency loss. The inductor value can be derived from the following equation:

$$L = \frac{V_{OUT} \times (V_{IN} - V_{OUT})}{V_{IN} \times I_L \times f_{OSC}}$$

Where  $I_L$  is inductor Ripple Current. Large value inductors result in lower ripple current and small value inductors result in high ripple current. For optimum voltage-positioning load transients, choose an inductor with DC series resistance in the  $50\text{m}\Omega$  to  $150\text{m}\Omega$  range.

### Input Capacitor Selection

With the maximum load current at 1.3A, the maximum ripple current through input capacitor is about 0.6Arms. A typical X7R or better grade ceramic capacitor with 6V rating and greater than  $10\mu\text{F}$  capacitance can handle this ripple current well. To minimize the potential noise problem, place this ceramic capacitor really close to VIN and GND pins. Care should be taken to minimize the loop area formed by  $C_{IN}$ , and VIN/GND pins.

### Output Capacitor Selection

The output capacitor is required to keep the output voltage ripple small and to ensure regulation loop stability. The output capacitor must have low impedance at the switching frequency. Ceramic capacitors with X5R or X7R dielectrics are recommended due to their low ESR and high ripple current ratings. The output ripple  $\Delta V_{OUT}$  is determined by:

$$\Delta V_{OUT} \leq \frac{V_{OUT} \times (V_{IN} - V_{OUT})}{V_{IN} \times f_{OSC} \times L} \times \left( \text{ESR} + \frac{1}{8 \times f_{OSC} \times C_{OUT}} \right)$$

A  $10\mu\text{F}$  ceramic can satisfy most applications.

### PCB Layout Recommendations

When laying out the printed circuit board, the following checking should be used to ensure proper operation of the MT3410L. Check the following in your layout:

- The power traces, consisting of the GND trace, the SW trace and the VIN trace should be kept short, direct and wide
- Does the (+) plates of  $C_{IN}$  connect to VIN as closely as possible. This capacitor provides the AC current to the internal power MOSFETs.
- Keep the switching node, SW, away from the sensitive  $V_{OUT}$  node.
- Keep the (-) plates of  $C_{IN}$  and  $C_{OUT}$  as close as possible

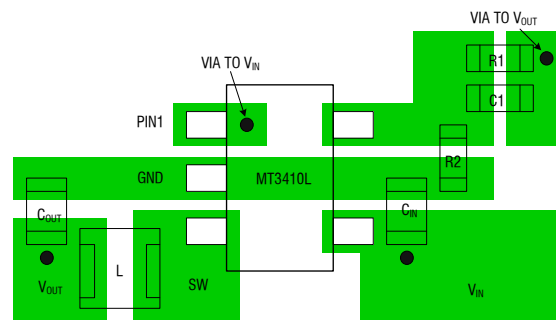
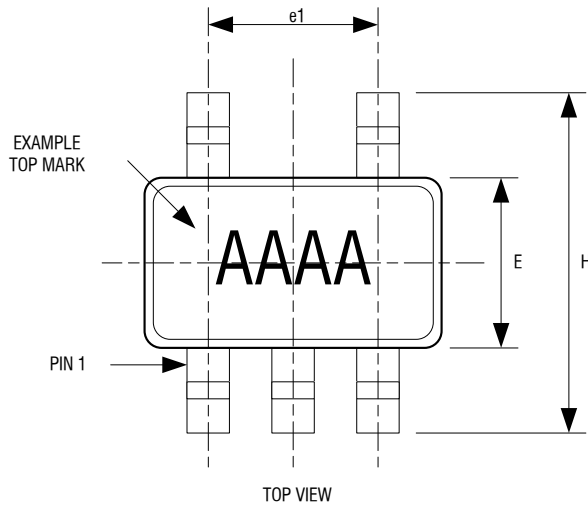

Figure 3. MT3410L Suggested Layout

## PACKAGE DESCRIPTION

### SOT23-5



### 5LD SOT-23 PACKAGE OUTLINE DIMENSIONS

Dimension	Min.	Max.
A	1.05	1.35
A1	0.04	0.15
B	0.3	0.5
C	0.09	0.2
D	2.8	3.0
H	2.5	3.1
E	1.5	1.7
e	0.95 REF.	
e1	1.90 REF.	
L1	0.2	0.55
L	0.35	0.8
Q	0°	10°

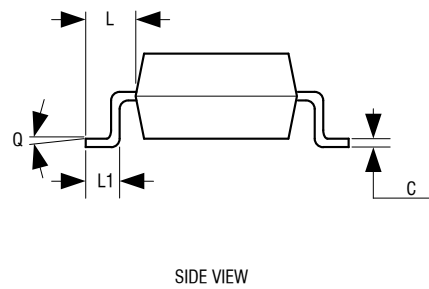
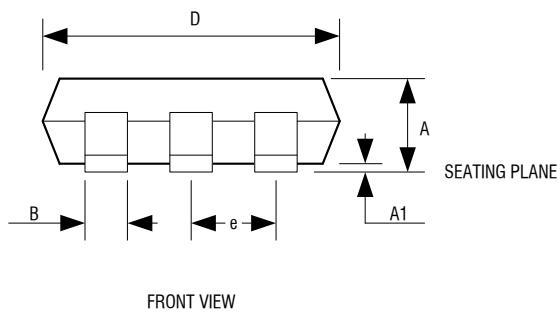

- NOTE:
- 1.DIMENSIONS ARE IN MILLIMETERS
  - 2.DRAWING NOT TO SCALE
  - 3.DIMENSIONS ARE INCLUSIVE OF PLATING
  - 4.DIMENSIONS ARE EXCLUSIVE OF MOLD FLASH AND METAL BURR