

150 mA, 28V LDO Regulator With Shutdown

Features

- 150 mA Output Current
- Low Drop Out Voltage, 260 mV typical @ 20 mA, $V_R = 3.3V$
- 50 μA Typical Quiescent Current
- 0.01 μA Typical Shutdown Current
- Input Operating Voltage Range: 2.0V to 28.0V
- Standard Output Voltage Options (1.8V, 2.5V, 3.0V, 3.3V, 5.0V, 10.0V, 12.0V)
- Output Voltage Accuracy: $\pm 2\%$
- Output voltages from 1.8V to 18.0V in 0.1V increments are available upon request
- Stable with Ceramic output capacitors
- Current Limit Protection With Current Foldback
- Shutdown pin
- High PSRR: 50 dB typical @ 1 kHz

Applications

- Cordless Phones, Wireless Communications
- PDAs, Notebook and Netbook Computers
- Digital Cameras
- Microcontroller Power
- Car Audio and Navigation Systems
- Home Appliances

Related Literature

- AN765, "Using Microchip's Micropower LDOs", DS00765, Microchip Technology Inc., ©2002
- AN766, "Pin-Compatible CMOS Upgrades to BiPolar LDOs", DS00766, Microchip Technology Inc., ©2002
- AN792, "A Method to Determine How Much Power a SOT23 Can Dissipate in an Application", DS00792, Microchip Technology Inc., ©2001

Description

The MCP1804 is a family of CMOS low dropout (LDO) voltage regulators that can deliver up to 150 mA of current while consuming only 50 μA of quiescent current (typical, $1.8V \leq V_{OUT} \leq 5.0V$). The input operating range is specified from 2.0V to 28.0V.

The MCP1804 is capable of delivering 100 mA with only 1300 mV (typical) of input to output voltage differential ($V_{OUT} = 3.3V$). The output voltage tolerance of the MCP1804 at +25°C is a maximum of $\pm 2\%$. Line regulation is $\pm 0.15\%$ typical at +25°C.

The LDO input and output is stable with 0.1 μF of input and output capacitance. Ceramic, tantalum or aluminum electrolytic capacitors can all be used for input and output. Overcurrent limit with current foldback to 40 mA (typical) provides short-circuit protection. A shutdown (SHDN) function allows the output to be enabled or disabled. When disabled, the MCP1804 draws only 0.01 μA of current (typical).

Package options include the SOT-23-5 (SOT-25), SOT-89-3, SOT-89-5, and SOT-223-3.

Package Types

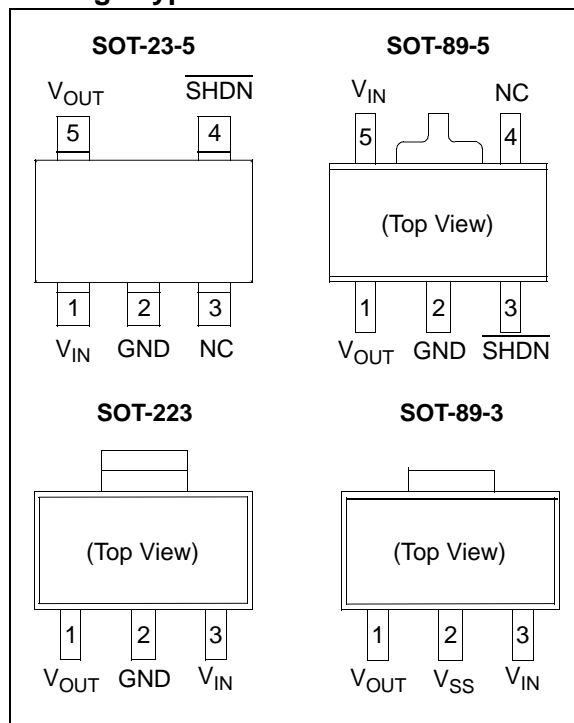

MCP1804

Functional Block Diagram

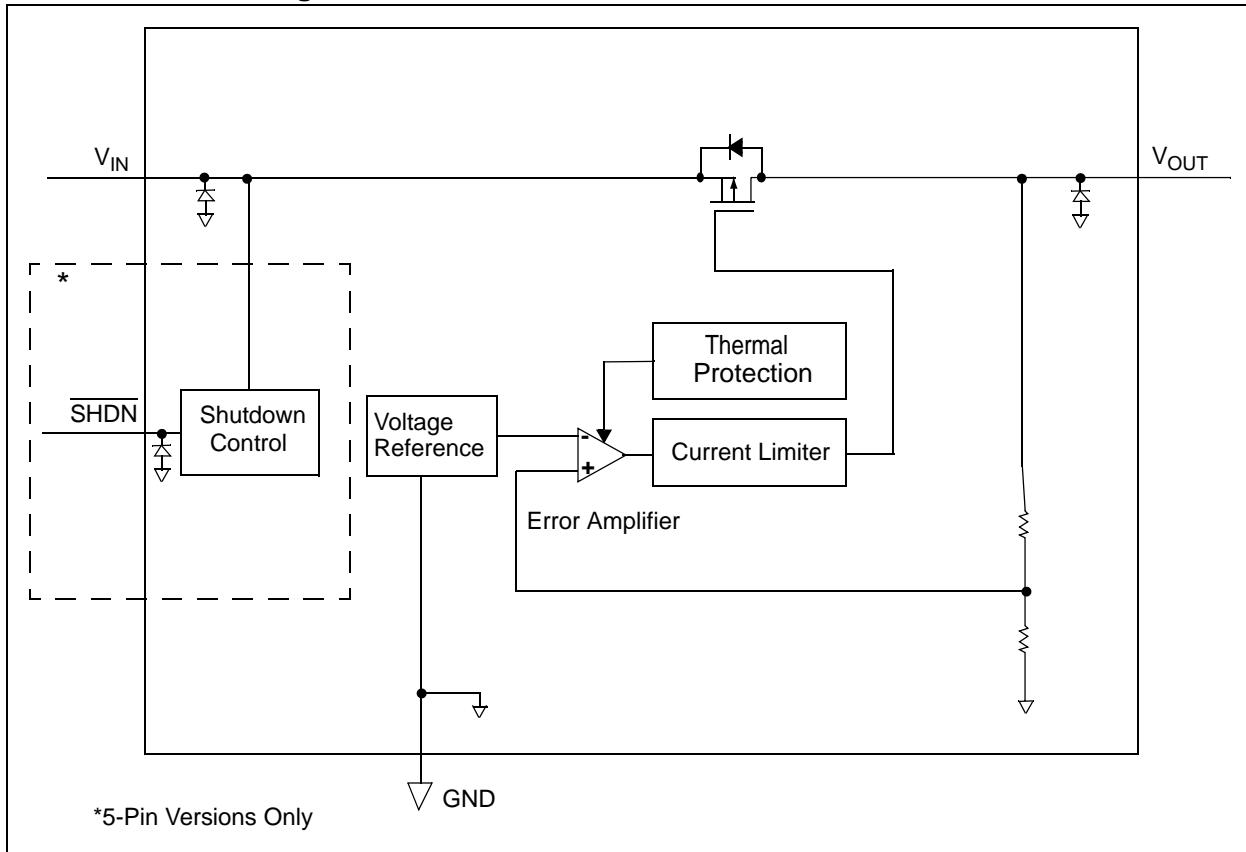

Typical Application Circuit

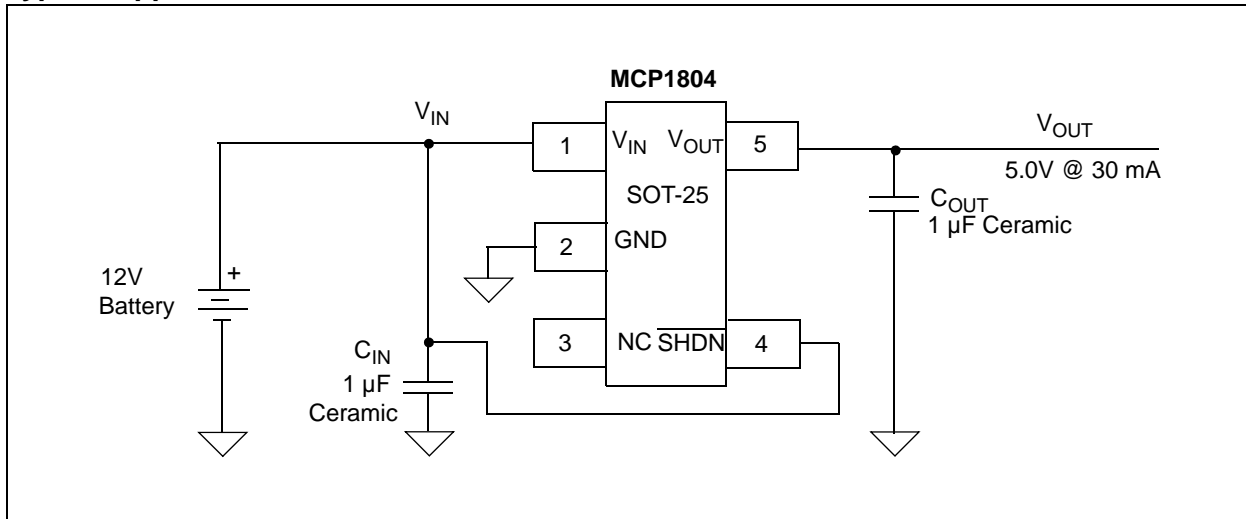

1.0 ELECTRICAL CHARACTERISTICS

Absolute Maximum Ratings †

Input Voltage	+30V
Output Current (Continuous).....	$P_D / (V_{IN} - V_{OUT})$ mA
Output Current (Peak).....	300 mA
Output Voltage	($V_{SS} - 0.3V$) to ($V_{IN} + 0.3V$)
SHDN Voltage.....	($V_{SS} - 0.3V$) to +30V
Continuous Power Dissipation:	
SOT-25.....	250 mW
SOT-89.....	500 mW
SOT-223.....	300 mW

† **Notice:** Stresses above those listed under “Maximum Ratings” may cause permanent damage to the device. This is a stress rating only and functional operation of the device at those or any other conditions above those indicated in the operational listings of this specification is not implied. Exposure to maximum rating conditions for extended periods may affect device reliability.

ELECTRICAL CHARACTERISTICS

Electrical Specifications: Unless otherwise specified, all limits are established for $V_{IN} = V_R + 2.0V$, Note 1 , $C_{OUT} = 1 \mu F$ (X7R), $C_{IN} = 1 \mu F$ (X7R), $V_{SHDN} = V_{IN}$, $T_A = +25^\circ C$						
Parameters	Sym	Min	Typ	Max	Units	Conditions
Input / Output Characteristics						
Input Operating Voltage	V_{IN}	2.0	—	28.0	V	Note 1
Input Quiescent Current	I_q	—	50	105	μA	$I_L = 0 \text{ mA}$ $1.8V \leq V_{OUT} \leq 5.0V$
		—	60	115	μA	$5.1V \leq V_{OUT} \leq 12.0V$
		—	65	125	μA	$12.1V \leq V_{OUT} \leq 18.0V$
Shutdown Current	I_{SHDN}	—	0.01	0.10	μA	$SHDN = 0V$
Maximum Output Current	I_{OUT_mA}	100	—	—	mA	$V_{IN} = V_R + 3.0V$ $V_{OUT} < 3.0V$
		150	—	—	mA	$V_{OUT} \geq 3.0V$
Current Limiter	I_{LIMIT}	—	200	—	mA	
Output Short Circuit Current	I_{OUT_SC}	—	40	—	mA	
Output Voltage Regulation	V_{OUT}	$V_R - 2.0\%$	V_R	$V_R + 2.0\%$	V	$I_{OUT} = 10 \text{ mA}$, Note 2
V_{OUT} Temperature Coefficient	TCV_{OUT}	—	± 100	—	ppm/ $^\circ C$	$I_{OUT} = 20 \text{ mA}$, $-40^\circ C \leq T_A \leq +85^\circ C$, Note 3
Line Regulation	$\frac{\Delta V_{OUT}}{(V_{OUT} \times \Delta V_{IN})}$	—	0.05	0.10	%/V	$(V_R + 2V) \leq V_{IN} \leq 28V$, Note 1 $I_{OUT} = 5 \text{ mA}$
		—	0.15	0.30	%/V	$I_{OUT} = 13 \text{ mA}$

- Note 1:** The minimum V_{IN} must meet one condition: $V_{IN} \geq (V_R + 2.0V)$.
- 2:** V_R is the nominal regulator output voltage with an input voltage of $V_{IN} = V_R + 2.0V$.
For example: $V_R = 1.8V, 2.5V, 3.0V, 3.3V$, etc.
- 3:** $TCV_{OUT} = (V_{OUT-HIGH} - V_{OUT-LOW}) * 10^6 / (V_R * \Delta \text{Temperature})$, $V_{OUT-HIGH}$ = highest voltage measured over the temperature range. $V_{OUT-LOW}$ = lowest voltage measured over the temperature range.
- 4:** Load regulation is measured at a constant junction temperature using low duty cycle pulse testing. Changes in output voltage due to heating effects are determined using thermal regulation specification TCV_{OUT} .
- 5:** Dropout voltage is defined as the input to output differential at which the output voltage drops 2% below its measured value with an applied input voltage of $V_R + 2.0V$.

MCP1804

ELECTRICAL CHARACTERISTICS (CONTINUED)

Electrical Specifications: Unless otherwise specified, all limits are established for $V_{IN} = V_R + 2.0V$, **Note 1**, $C_{OUT} = 1 \mu F$ (X7R), $C_{IN} = 1 \mu F$ (X7R), $V_{SHDN} = V_{IN}$, $T_A = +25^\circ C$

Parameters	Sym	Min	Typ	Max	Units	Conditions		
Load Regulation	$\Delta V_{OUT}/V_{OUT}$						$I_L = 1.0 \text{ mA to } 50 \text{ mA}$, Note 4	
		—	50	90		mV	$1.8V \leq V_{OUT} \leq 5.0V$	
		—	110	175		mV	$5.1V \leq V_{OUT} \leq 12.0V$	
		—	180	275		mV	$12.1V \leq V_{OUT} \leq 18.0V$	
Dropout Voltage Note 1, Note 5	$V_{DROPOUT}$						$I_L = 20 \text{ mA}$	
		—	550	710		V	$1.8V \leq V_R \leq 1.9V$	
		—	450	600		V	$2.0V \leq V_R \leq 2.1V$	
		—	390	520		V	$2.2V \leq V_R \leq 2.4V$	
		—	310	450		V	$2.5V \leq V_R \leq 2.9V$	
		—	260	360		V	$3.0V \leq V_R \leq 3.9V$	
		—	220	320		V	$4.0V \leq V_R \leq 4.9V$	
		—	190	280		V	$5.0V \leq V_R \leq 6.4V$	
		—	170	230		V	$6.5V \leq V_R \leq 8.0V$	
		—	130	190		V	$8.1V \leq V_R \leq 10.0V$	
		—	120	170		V	$10.1V \leq V_R \leq 18.0V$	
								$I_L = 100 \text{ mA}$
		—	2200	2700		V	$1.8V \leq V_R \leq 1.9V$	
		—	1900	2600		V	$2.0V \leq V_R \leq 2.1V$	
		—	1700	2200		V	$2.2V \leq V_R \leq 2.4V$	
		—	1500	1900		V	$2.5V \leq V_R \leq 2.9V$	
		—	1300	1700		V	$3.0V \leq V_R \leq 3.9V$	
		—	1100	1500		V	$4.0V \leq V_R \leq 4.9V$	
		—	1000	1300		V	$5.0V \leq V_R \leq 6.4V$	
—	800	1150		V	$6.5V \leq V_R \leq 8.0V$			
—	700	950		V	$8.1V \leq V_R \leq 10.0V$			
—	650	850		V	$10.1V \leq V_R \leq 18.0V$			
SHDN "H" Voltage	V_{SHDN_H}	1.1	—	V_{IN}	V	$V_{IN} = 28V$		
SHDN "L" Voltage	V_{SHDN_L}	0	—	0.35	V	$V_{IN} = 28V$		
SHDN Current	I_{SHDN}	-0.1	—	0.1	μA	$V_{IN} = 28V$, $V_{SHDN} = GND$ or V_{IN}		

- Note 1:** The minimum V_{IN} must meet one condition: $V_{IN} \geq (V_R + 2.0V)$.
- 2:** V_R is the nominal regulator output voltage with an input voltage of $V_{IN} = V_R + 2.0V$.
For example: $V_R = 1.8V, 2.5V, 3.0V, 3.3V$, etc.
- 3:** $TCV_{OUT} = (V_{OUT-HIGH} - V_{OUT-LOW}) * 10^6 / (V_R * \Delta Temperature)$, $V_{OUT-HIGH}$ = highest voltage measured over the temperature range. $V_{OUT-LOW}$ = lowest voltage measured over the temperature range.
- 4:** Load regulation is measured at a constant junction temperature using low duty cycle pulse testing. Changes in output voltage due to heating effects are determined using thermal regulation specification TCV_{OUT} .
- 5:** Dropout voltage is defined as the input to output differential at which the output voltage drops 2% below its measured value with an applied input voltage of $V_R + 2.0V$.

ELECTRICAL CHARACTERISTICS (CONTINUED)

Electrical Specifications: Unless otherwise specified, all limits are established for $V_{IN} = V_R + 2.0V$, **Note 1**, $C_{OUT} = 1 \mu F$ (X7R), $C_{IN} = 1 \mu F$ (X7R), $V_{SHDN} = V_{IN}$, $T_A = +25^\circ C$

Parameters	Sym	Min	Typ	Max	Units	Conditions
Power Supply Ripple Rejection Ratio	PSRR	—	50	—	dB	$f = 1 \text{ kHz}$, $I_L = 20 \text{ mA}$, $V_{INAC} = 0.5V \text{ pk-pk}$, $C_{IN} = 0 \mu F$
Thermal Shutdown Protection	TSD	—	150	—	$^\circ C$	T_J
Thermal Shutdown Hysteresis	ΔTSD	—	25	—	$^\circ C$	

Note 1: The minimum V_{IN} must meet one condition: $V_{IN} \geq (V_R + 2.0V)$.

2: V_R is the nominal regulator output voltage with an input voltage of $V_{IN} = V_R + 2.0V$.

For example: $V_R = 1.8V, 2.5V, 3.0V, 3.3V$, etc.

3: $TCV_{OUT} = (V_{OUT-HIGH} - V_{OUT-LOW}) * 10^6 / (V_R * \Delta \text{Temperature})$, $V_{OUT-HIGH}$ = highest voltage measured over the temperature range. $V_{OUT-LOW}$ = lowest voltage measured over the temperature range.

4: Load regulation is measured at a constant junction temperature using low duty cycle pulse testing. Changes in output voltage due to heating effects are determined using thermal regulation specification TCV_{OUT} .

5: Dropout voltage is defined as the input to output differential at which the output voltage drops 2% below its measured value with an applied input voltage of $V_R + 2.0V$.

TEMPERATURE SPECIFICATIONS

Parameters	Sym	Min	Typ	Max	Units	Conditions
Temperature Ranges						
Operating Temperature Range	T_A	-40		+85	$^\circ C$	
Storage Temperature Range	T_{stg}	-55		+125	$^\circ C$	
Thermal Package Resistance						
Thermal Resistance, SOT-25	θ_{JA}	—	256	—	$^\circ C/W$	EIA/JEDEC JESD51-7 FR-4 0.063 4-Layer Board
	θ_{JC}	—	81	—		
Thermal Resistance, SOT-89	θ_{JA}	—	180	—	$^\circ C/W$	EIA/JEDEC JESD51-7 FR-4 0.063 4-Layer Board
	θ_{JC}	—	100	—		
Thermal Resistance, SOT-223	θ_{JA}	—	62	—	$^\circ C/W$	EIA/JEDEC JESD51-7 FR-4 0.063 4-Layer Board
	θ_{JC}	—	15	—		

MCP1804

NOTES:

2.0 TYPICAL PERFORMANCE CURVES

Note: The graphs and tables provided following this note are a statistical summary based on a limited number of samples and are provided for informational purposes only. The performance characteristics listed herein are not tested or guaranteed. In some graphs or tables, the data presented may be outside the specified operating range (e.g., outside specified power supply range) and therefore outside the warranted range.

Note: Unless otherwise indicated: $C_{OUT} = 1 \mu\text{F}$ Ceramic (X7R), $C_{IN} = 1 \mu\text{F}$ Ceramic (X7R), $T_A = +25^\circ\text{C}$, $V_{IN} = V_R + 2.0\text{V}$.

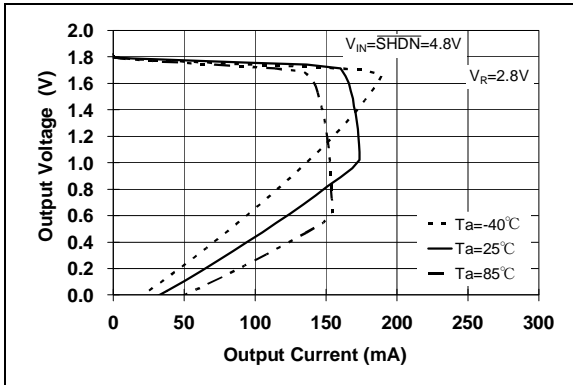

FIGURE 2-1: Output Voltage vs. Output Current.

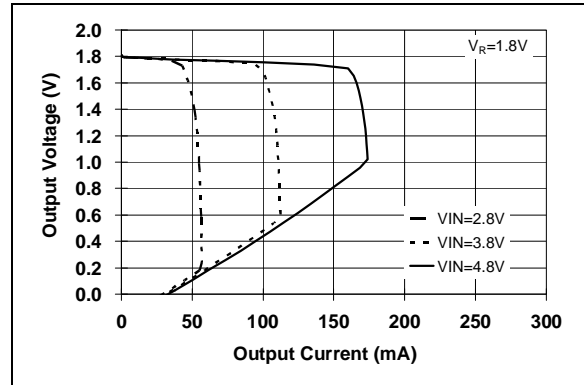

FIGURE 2-4: Output Voltage vs. Output Current.

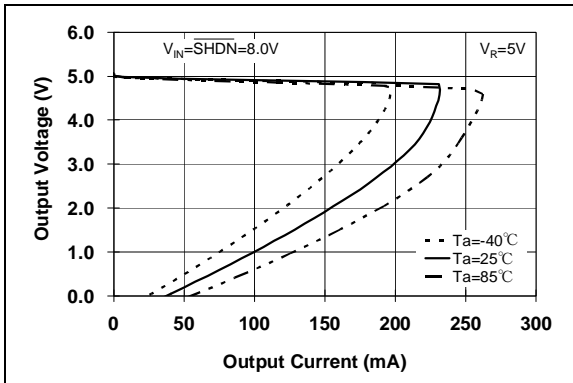

FIGURE 2-2: Output Voltage vs. Output Current.

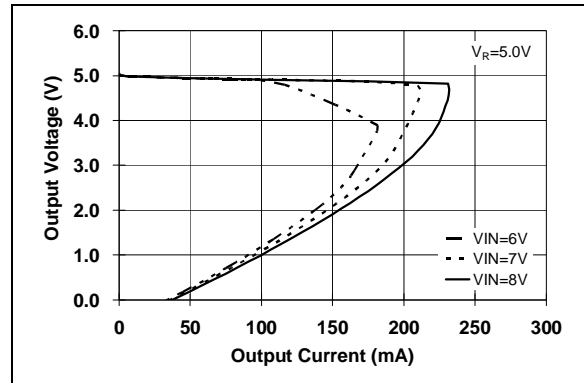

FIGURE 2-5: Output Voltage vs. Output Current.

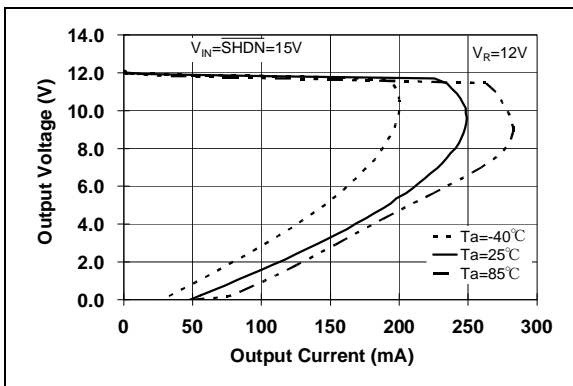

FIGURE 2-3: Output Voltage vs. Output Current.

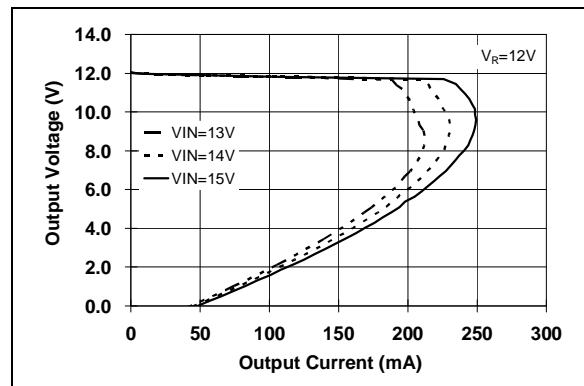

FIGURE 2-6: Output Voltage vs. Output Current.

MCP1804

Note: Unless otherwise indicated: $C_{OUT} = 1 \mu\text{F}$ Ceramic (X7R), $C_{IN} = 1 \mu\text{F}$ Ceramic (X7R), $T_A = +25^\circ\text{C}$, $V_{IN} = V_R + 2.0\text{V}$.

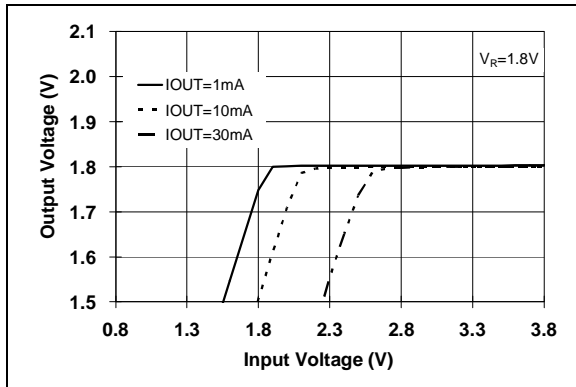

FIGURE 2-7: Output Voltage vs. Input Voltage.

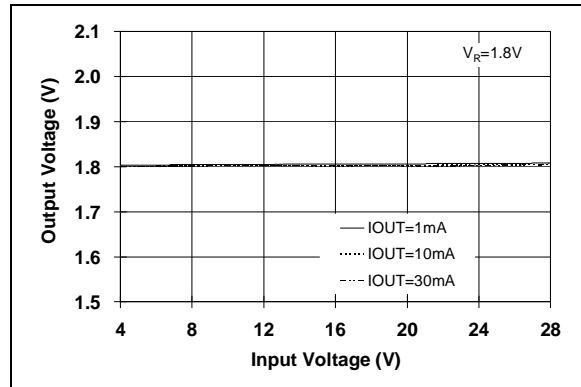

FIGURE 2-10: Output Voltage vs. Input Voltage.

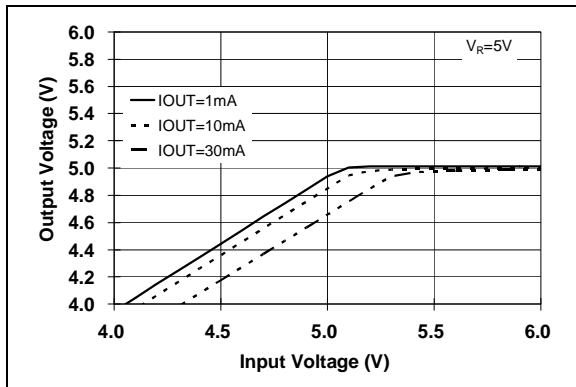

FIGURE 2-8: Output Voltage vs. Input Voltage.

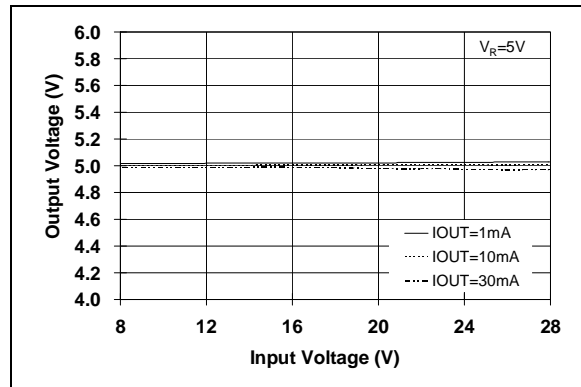

FIGURE 2-11: Output Voltage vs. Input Voltage.

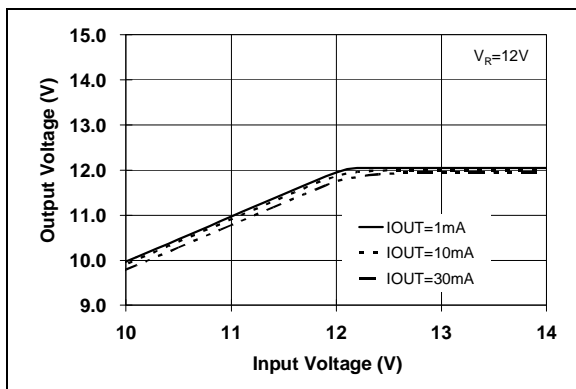

FIGURE 2-9: Output Voltage vs. Input Voltage.

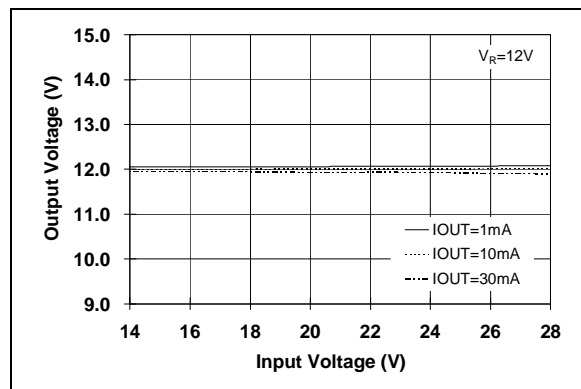

FIGURE 2-12: Output Voltage vs. Input Voltage.

Note: Unless otherwise indicated: $C_{OUT} = 1 \mu\text{F}$ Ceramic (X7R), $C_{IN} = 1 \mu\text{F}$ Ceramic (X7R), $T_A = +25^\circ\text{C}$, $V_{IN} = V_R + 2.0\text{V}$.

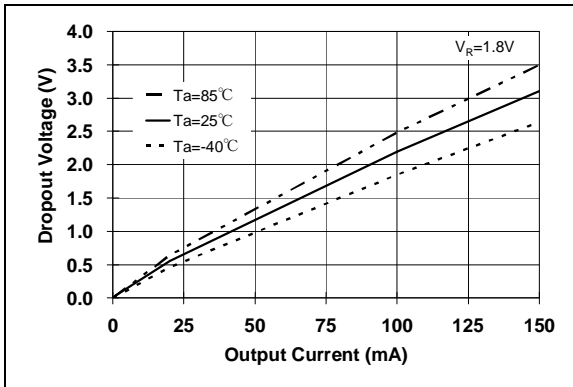

FIGURE 2-13: Dropout Voltage vs. Load Current.

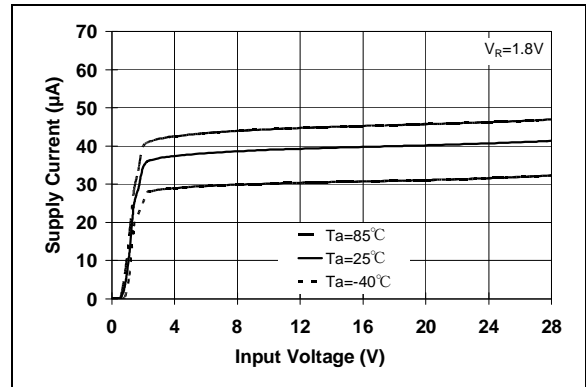

FIGURE 2-16: Supply Current vs. Input Voltage.

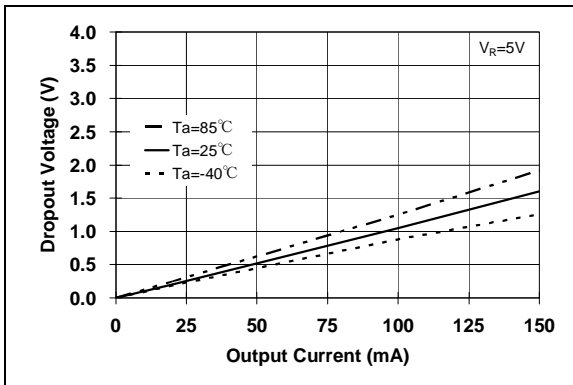

FIGURE 2-14: Dropout Voltage vs. Load Current.

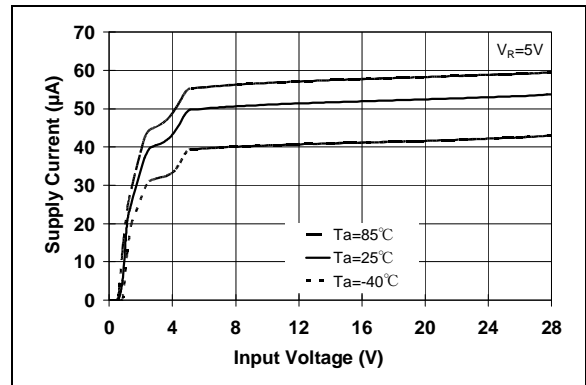

FIGURE 2-17: Supply Current vs. Input Voltage.

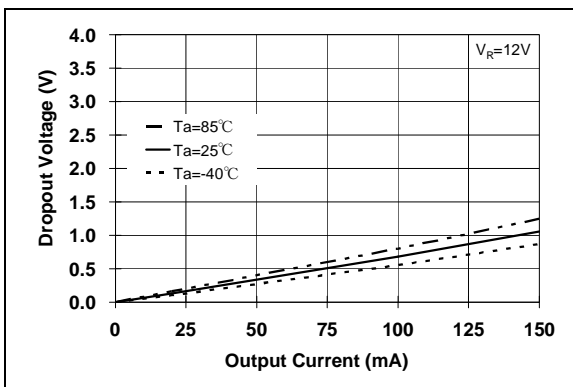

FIGURE 2-15: Dropout Voltage vs. Load Current.

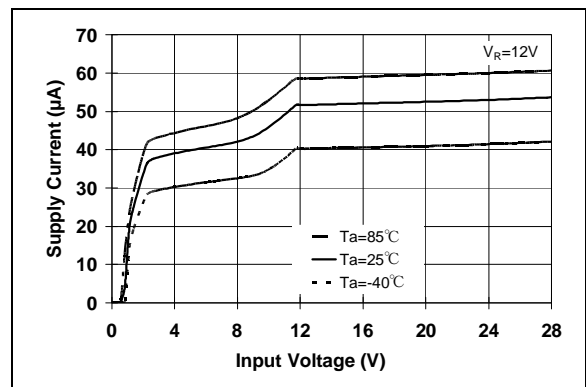

FIGURE 2-18: Supply Current vs. Input Voltage.

MCP1804

Note: Unless otherwise indicated: $C_{OUT} = 1 \mu\text{F}$ Ceramic (X7R), $C_{IN} = 1 \mu\text{F}$ Ceramic (X7R), $T_A = +25^\circ\text{C}$, $V_{IN} = V_R + 2.0\text{V}$.

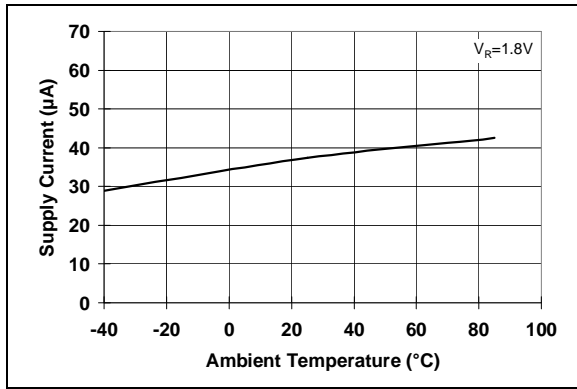

FIGURE 2-19: Supply Current vs. Input Voltage.

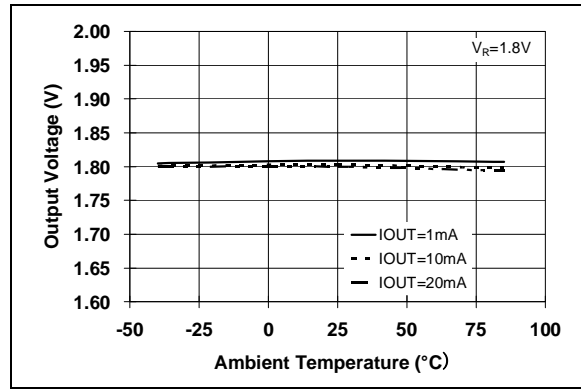

FIGURE 2-22: Output Voltage vs. Ambient Temperature.

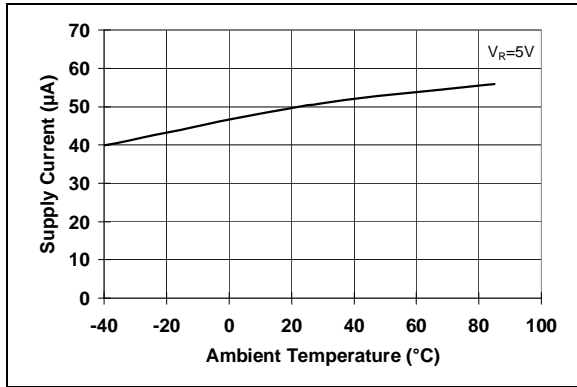

FIGURE 2-20: Supply Current vs. Input Voltage.

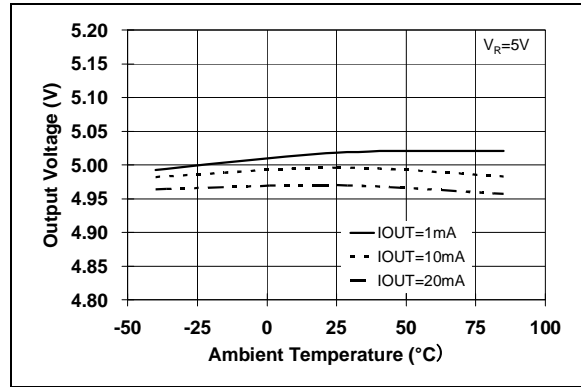

FIGURE 2-23: Output Voltage vs. Ambient Temperature.

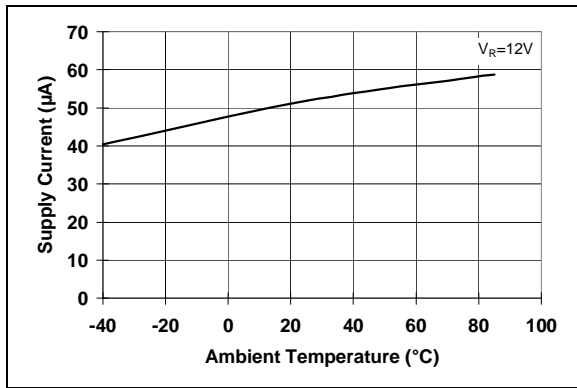

FIGURE 2-21: Supply Current vs. Input Voltage.

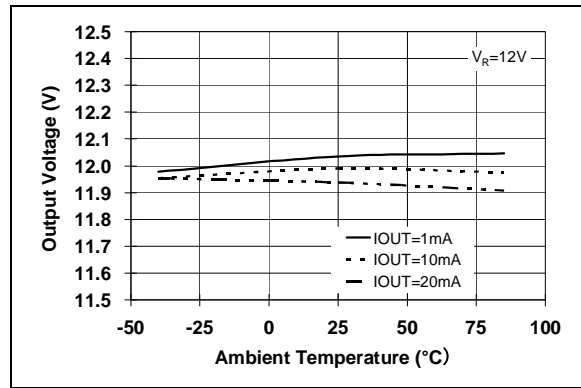

FIGURE 2-24: Output Voltage vs. Ambient Temperature.

Note: Unless otherwise indicated: $C_{OUT} = 1 \mu\text{F}$ Ceramic (X7R), $C_{IN} = 1 \mu\text{F}$ Ceramic (X7R), $T_A = +25^\circ\text{C}$, $V_{IN} = V_R + 2.0\text{V}$.

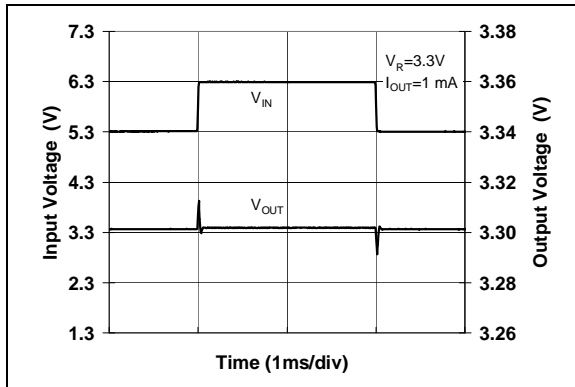

FIGURE 2-25: Dynamic Line Response.

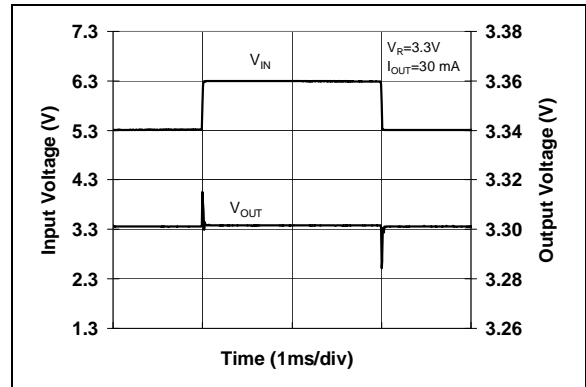

FIGURE 2-28: Dynamic Line Response.

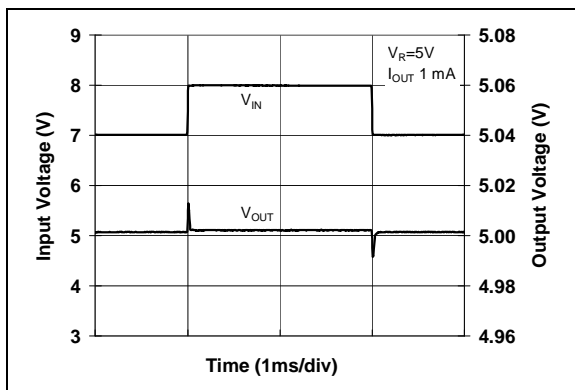

FIGURE 2-26: Dynamic Line Response.

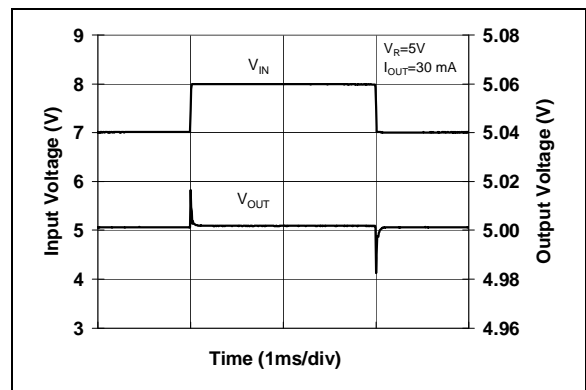

FIGURE 2-29: Dynamic Line Response.

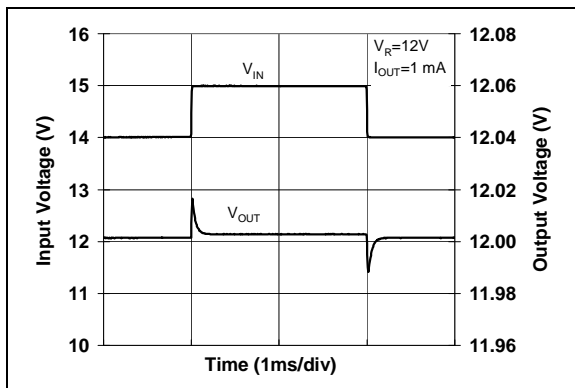

FIGURE 2-27: Dynamic Line Response.

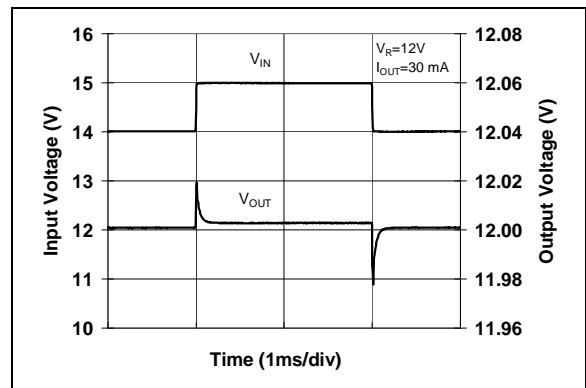

FIGURE 2-30: Dynamic Line Response.

MCP1804

Note: Unless otherwise indicated: $C_{OUT} = 1 \mu\text{F}$ Ceramic (X7R), $C_{IN} = 1 \mu\text{F}$ Ceramic (X7R), $T_A = +25^\circ\text{C}$, $V_{IN} = V_R + 2.0\text{V}$.

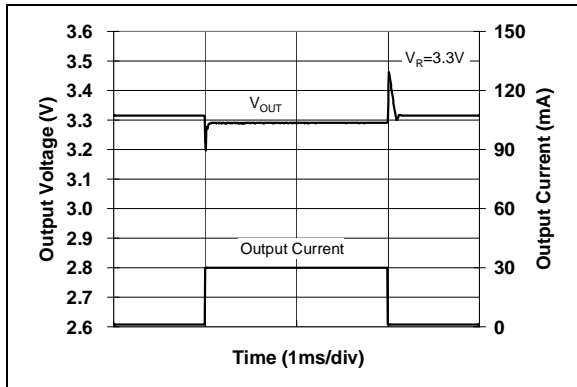

FIGURE 2-31: Dynamic Load Response.

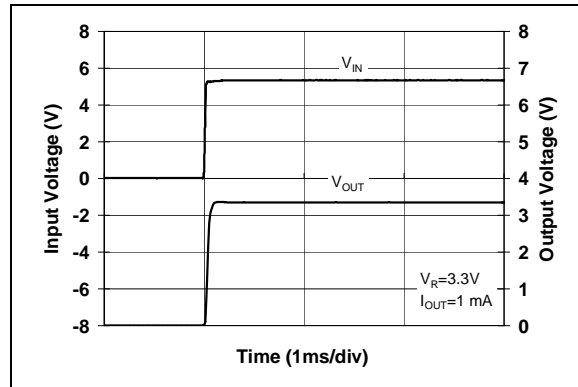

FIGURE 2-34: Startup Response.

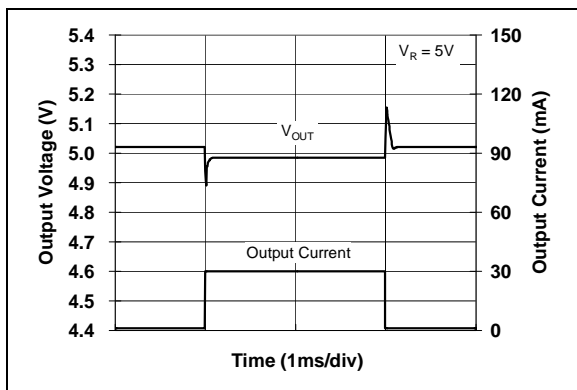

FIGURE 2-32: Dynamic Load Response.

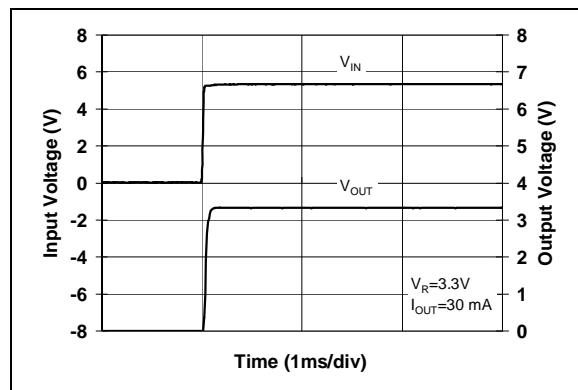

FIGURE 2-35: Startup Response.

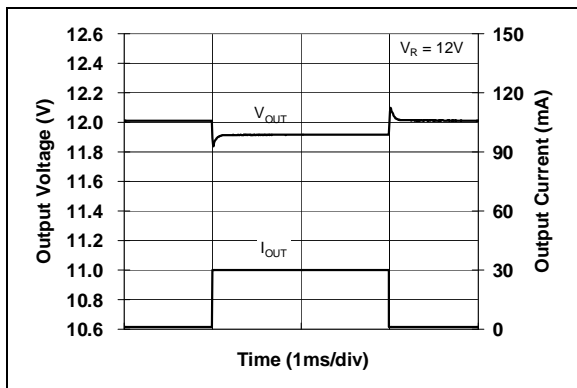

FIGURE 2-33: Dynamic Load Response.

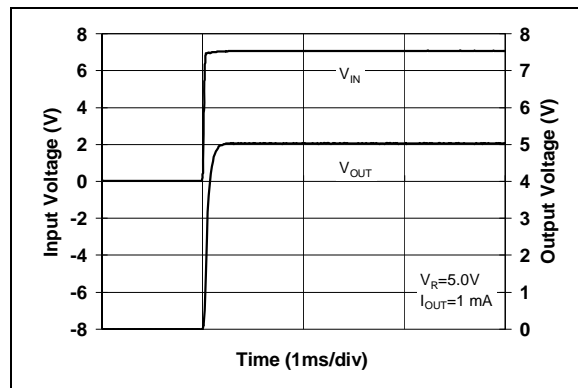

FIGURE 2-36: Startup Response.

Note: Unless otherwise indicated: $C_{OUT} = 1 \mu\text{F}$ Ceramic (X7R), $C_{IN} = 1 \mu\text{F}$ Ceramic (X7R), $T_A = +25^\circ\text{C}$, $V_{IN} = V_R + 2.0\text{V}$.

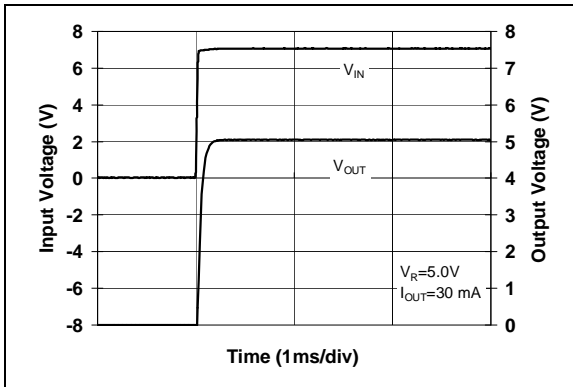

FIGURE 2-37: Startup Response.

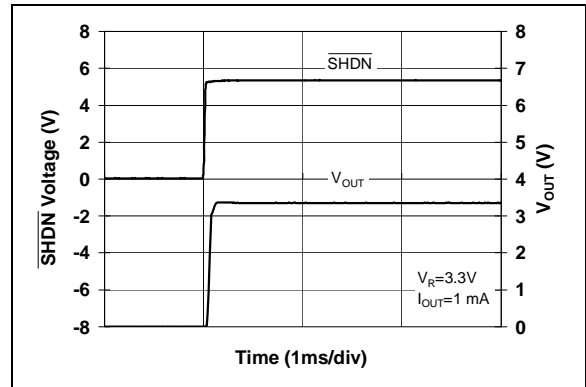

FIGURE 2-40: SHDN Response.

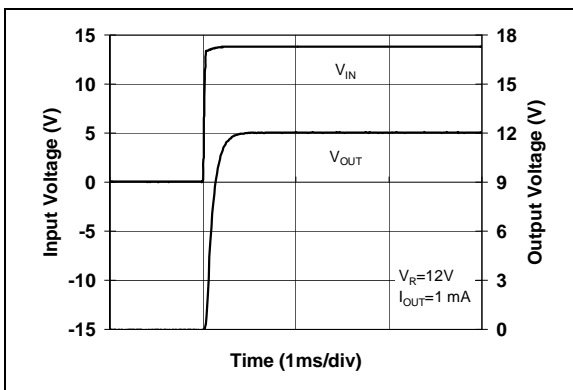

FIGURE 2-38: Startup Response.

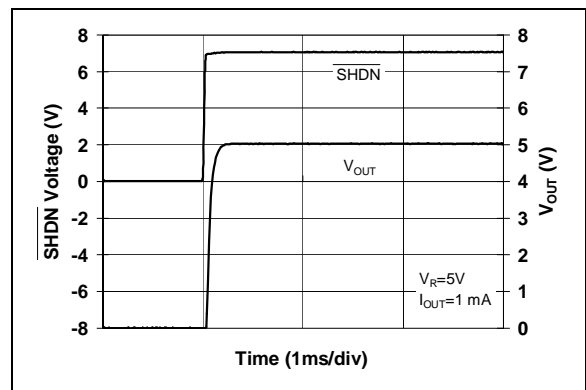

FIGURE 2-41: SHDN Response.

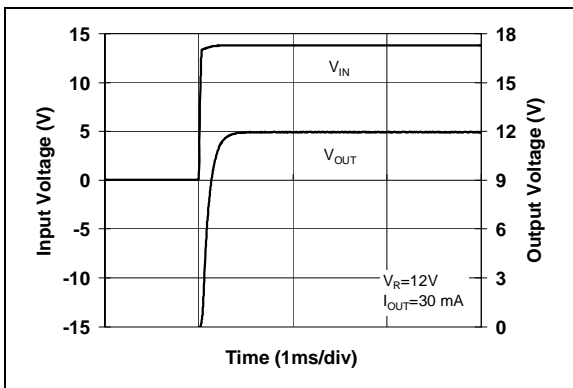

FIGURE 2-39: Startup Response.

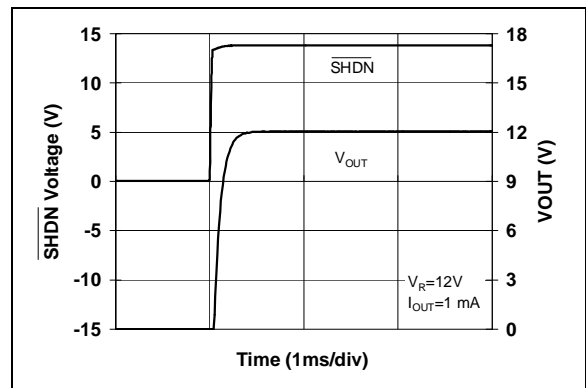

FIGURE 2-42: SHDN Response.

MCP1804

Note: Unless otherwise indicated: $C_{OUT} = 1 \mu\text{F}$ Ceramic (X7R), $C_{IN} = 1 \mu\text{F}$ Ceramic (X7R), $T_A = +25^\circ\text{C}$, $V_{IN} = V_R + 2.0\text{V}$.

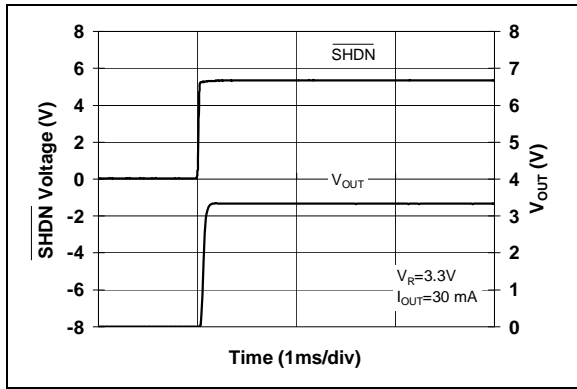

FIGURE 2-43: SHDN Response.

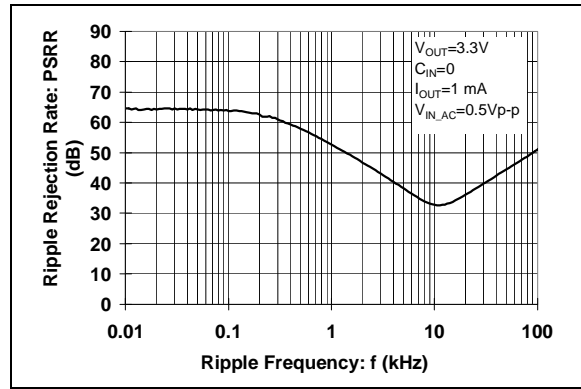

FIGURE 2-46: PSRR 3.3V @ 1 mA.

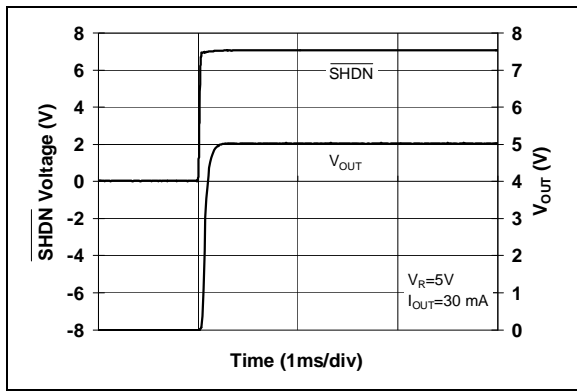

FIGURE 2-44: SHDN Response.

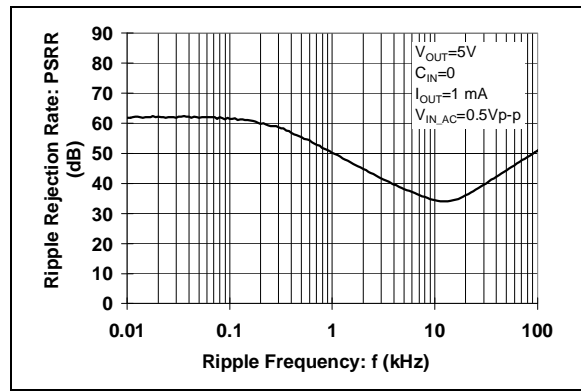

FIGURE 2-47: PSRR 5.0V @ 1 mA.

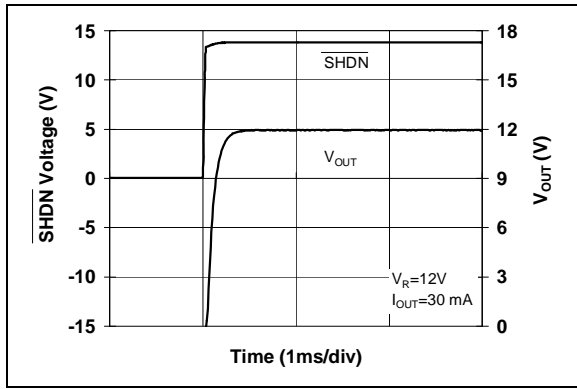

FIGURE 2-45: SHDN Response.

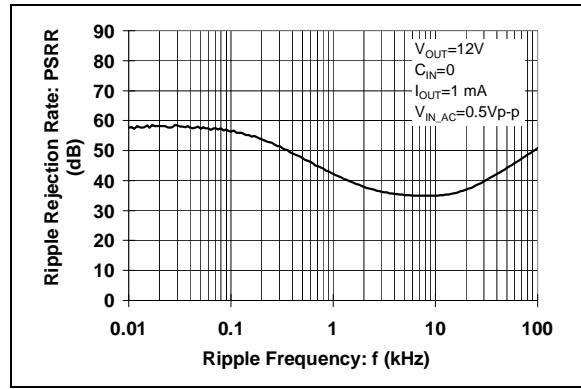

FIGURE 2-48: PSRR 12.0V @ 1 mA.

Note: Unless otherwise indicated: $C_{OUT} = 1 \mu\text{F}$ Ceramic (X7R), $C_{IN} = 1 \mu\text{F}$ Ceramic (X7R), $T_A = +25^\circ\text{C}$, $V_{IN} = V_R + 2.0\text{V}$.

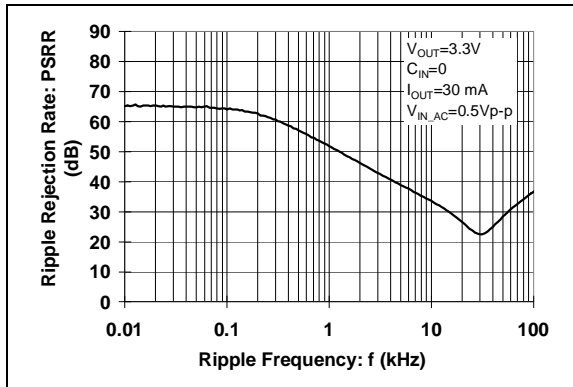

FIGURE 2-49: PSRR 3.3V @ 30 mA.

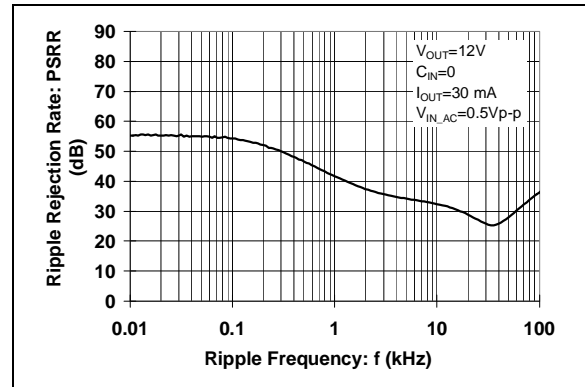

FIGURE 2-51: PSRR 12.0V @ 30 mA.

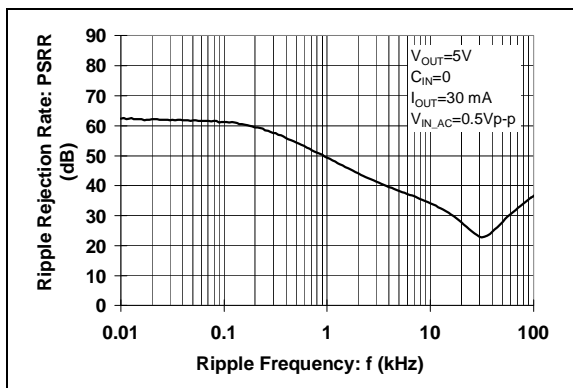

FIGURE 2-50: PSRR 5.0V @ 30 mA.

MCP1804

NOTES:

3.0 PIN DESCRIPTIONS

The descriptions of the pins are listed in [Table 3-1](#).

TABLE 3-1: MCP1804 PIN FUNCTION TABLE

MCP1804			Symbol	Description
SOT-25	SOT-89-5	SOT-223-3, SOT89-3		
1	5	3	V_{IN}	Unregulated Supply Voltage
2	2, TAB	2, TAB	GND	Ground Terminal
3	4	—	NC	No connection
4	3	—	$\overline{\text{SHDN}}$	Shutdown
5	1	1	V_{OUT}	Regulated Voltage Output

3.1 Unregulated Input Voltage (V_{IN})

Connect V_{IN} to the input unregulated source voltage. Like all low dropout linear regulators, low source impedance is necessary for the stable operation of the LDO. The amount of capacitance required to ensure low source impedance will depend on the proximity of the input source capacitors or battery type. For most applications, 0.1 μF to 1.0 μF of capacitance will ensure stable operation of the LDO circuit. The type of capacitor used can be ceramic, tantalum or aluminum electrolytic. The low ESR characteristics of the ceramic will yield better noise and PSRR performance at high-frequency.

3.2 Ground Terminal (GND)

Regulator ground. Tie GND to the negative side of the output and the negative side of the input capacitor. Only the LDO bias current (50 to 60 μA typical) flows out of this pin; there is no high current. The LDO output regulation is referenced to this pin. Minimize voltage drops between this pin and the negative side of the load.

3.3 Shutdown Input ($\overline{\text{SHDN}}$)

The $\overline{\text{SHDN}}$ input is used to turn the LDO output voltage on and off. When the $\overline{\text{SHDN}}$ input is at a logic-high level, the LDO output voltage is enabled. When the $\overline{\text{SHDN}}$ input is pulled to a logic-low level, the LDO output voltage is disabled and the LDO enters a low quiescent current shutdown state where the typical quiescent current is 0.01 μA . The $\overline{\text{SHDN}}$ pin does not have an internal pullup or pulldown resistor. The $\overline{\text{SHDN}}$ pin must be connected to either V_{IN} or GND to prevent the device from becoming unstable.

3.4 Regulated Output Voltage (V_{OUT})

Connect V_{OUT} to the positive side of the load and the positive terminal of the output capacitor. The positive side of the output capacitor should be physically located as close to the LDO V_{OUT} pin as is practical. The current flowing out of this pin is equal to the DC load current. For most applications, 0.1 μF to 1.0 μF of capacitance will ensure stable operation of the LDO circuit. Larger values may be used to improve dynamic load response. The type of capacitor used can be ceramic, tantalum or aluminum electrolytic. The low ESR characteristics of the ceramic will yield better noise and PSRR performance at high-frequency.

MCP1804

NOTES:

4.0 DETAILED DESCRIPTION

4.1 Output Regulation

A portion of the LDO output voltage is fed back to the internal error amplifier and compared with the precision internal bandgap reference. The error amplifier output will adjust the amount of current that flows through the P-Channel pass transistor, thus regulating the output voltage to the desired value. Any changes in input voltage or output current will cause the error amplifier to respond and adjust the output voltage to the target voltage (refer to [Figure 4-1](#)).

4.2 Overcurrent

The MCP1804 internal circuitry monitors the amount of current flowing through the P-Channel pass transistor. In the event that the load current reaches the current limiter level of 200 mA (typical), the current limiter circuit will operate and the output voltage will drop. As the output voltage drops, the internal current foldback circuit will further reduce the output voltage causing the output current to decrease. When the output is shorted, a typical output current of 50 mA flows.

4.3 Shutdown

The $\overline{\text{SHDN}}$ input is used to turn the LDO output voltage on and off. When the $\overline{\text{SHDN}}$ input is at a logic-high level, the LDO output voltage is enabled. When the $\overline{\text{SHDN}}$ input is pulled to a logic-low level, the LDO output voltage is disabled and the LDO enters a low quiescent current shutdown state where the typical quiescent current is 0.01 μA . The $\overline{\text{SHDN}}$ pin does not have an internal pullup or pulldown resistor. Therefore the $\overline{\text{SHDN}}$ pin must be pulled either high or low to prevent the device from becoming unstable. The internal device current will increase when the device is operational and current flows through the pullup or pull-down resistor to the $\overline{\text{SHDN}}$ pin internal logic. The $\overline{\text{SHDN}}$ pin internal logic is equivalent to an inverter input.

4.4 Output Capacitor

The MCP1804 requires a minimum output capacitance of 0.1 μF to 1.0 μF for output voltage stability. Ceramic capacitors are recommended because of their size, cost and environmental robustness qualities.

Aluminum-electrolytic and tantalum capacitors can be used on the LDO output as well. The output capacitor should be located as close to the LDO output as is practical. Ceramic materials X7R and X5R have low temperature coefficients.

Larger LDO output capacitors can be used with the MCP1804 to improve dynamic performance and power supply ripple rejection performance. Aluminum-electrolytic capacitors are not recommended for low temperature applications of $< -25^{\circ}\text{C}$.

4.5 Input Capacitor

Low input source impedance is necessary for the LDO output to operate properly. When operating from batteries, or in applications with long lead length (> 10 inches) between the input source and the LDO, some input capacitance is recommended. A minimum of 0.1 μF to 1.0 μF is recommended for most applications.

For applications that have output step load requirements, the input capacitance of the LDO is very important. The input capacitance provides the LDO with a good local low-impedance source to pull the transient currents from in order to respond quickly to the output load step. For good step response performance, the input capacitor should be of equivalent or higher value than the output capacitor. The capacitor should be placed as close to the input of the LDO as is practical. Larger input capacitors will also help reduce any high-frequency noise on the input and output of the LDO and reduce the effects of any inductance that exists between the input source voltage and the input capacitance of the LDO.

4.6 Thermal Shutdown

The MCP1804 thermal shutdown circuitry protects the device when the internal junction temperature reaches the typical thermal limit value of $+150^{\circ}\text{C}$. The thermal limit shuts off the output drive transistor. Device output will resume when the internal junction temperature falls below the thermal limit value by an amount equal to the thermal limit hysteresis value of $+25^{\circ}\text{C}$.

MCP1804

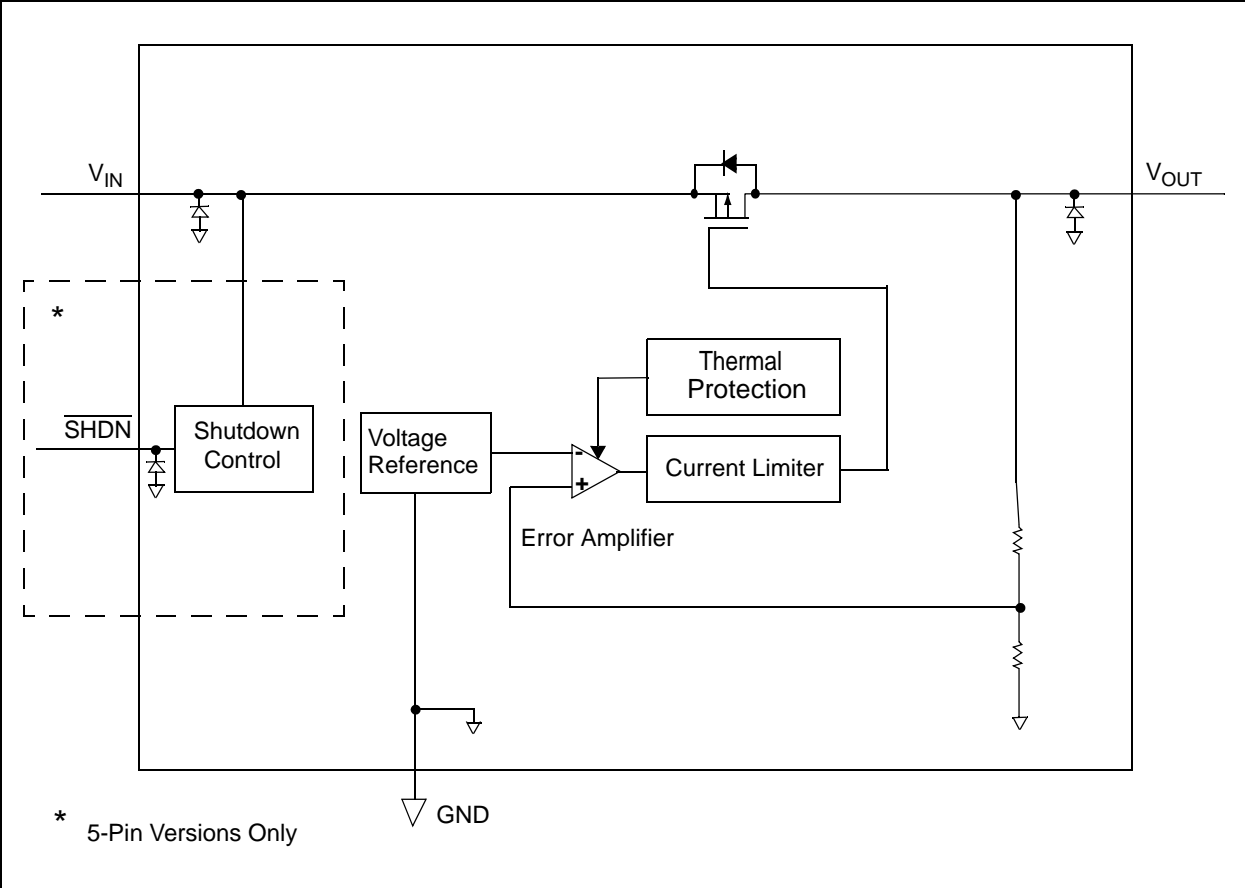

FIGURE 4-1: Block Diagram.

5.0 FUNCTIONAL DESCRIPTION

The MCP1804 CMOS linear regulator is intended for applications that need the low current consumption while maintaining output voltage regulation. The operating continuous load range of the MCP1804 is from 0 mA to 150 mA. The input operating voltage range is from 2.0V to 28.0V, making it capable of operating from a single 12V battery or single and multiple Li-Ion cell batteries.

5.1 Input

The input of the MCP1804 is connected to the source of the P-Channel PMOS pass transistor. As with all LDO circuits, a relatively low source impedance ($< 10\Omega$) is needed to prevent the input impedance from causing the LDO to become unstable. The size and type of the capacitor needed depends heavily on the input source type (battery, power supply) and the output current range of the application. For most applications a 0.1 μF ceramic capacitor will be sufficient to ensure circuit stability. Larger values can be used to improve circuit AC performance.

5.2 Output

The maximum rated continuous output current for the MCP1804 is 150 mA.

A minimum output capacitance of 0.1 μF to 1.0 μF is required for small signal stability in applications that have up to 150 mA output current capability. The capacitor type can be ceramic, tantalum or aluminum electrolytic.

MCP1804

NOTES:

6.0 APPLICATION CIRCUITS AND ISSUES

6.1 Typical Application

The MCP1804 is most commonly used as a voltage regulator. Its low quiescent current and wide input voltage range make it ideal for Li-Ion and 12V battery-powered applications.

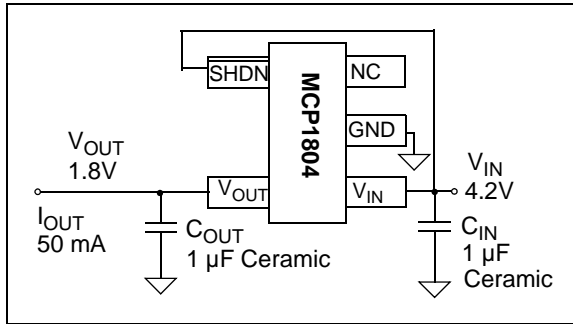

FIGURE 6-1: Typical Application Circuit.

6.1.1 APPLICATION INPUT CONDITIONS

Package Type	= SOT25
Input Voltage Range	= 3.8V to 4.2V
V _{IN} maximum	= 4.6V
V _{OUT} typical	= 1.8V
I _{OUT}	= 50 mA maximum

6.2 Power Calculations

6.2.1 POWER DISSIPATION

The internal power dissipation of the MCP1804 is a function of input voltage, output voltage and output current. The power dissipation, as a result of the quiescent current draw, is so low, it is insignificant ($50.0 \mu\text{A} \times V_{\text{IN}}$). The following equation can be used to calculate the internal power dissipation of the LDO.

EQUATION 6-1:

$$P_{LDO} = (V_{IN(MAX)} - V_{OUT(MIN)}) \times I_{OUT(MAX)}$$

Where:

P _{LDO}	= LDO Pass device internal power dissipation
V _{IN(MAX)}	= Maximum input voltage
V _{OUT(MIN)}	= LDO minimum output voltage

The maximum continuous operating temperature specified for the MCP1804 is +85°C. To estimate the internal junction temperature of the MCP1804, the total internal power dissipation is multiplied by the thermal resistance from junction to ambient (R_{θJA}). The thermal resistance from junction to ambient for the SOT-25 pin package is estimated at 256°C/W.

EQUATION 6-2:

$$T_{J(MAX)} = P_{TOTAL} \times R\theta_{JA} + T_{AMAX}$$

Where:

T _{J(MAX)}	= Maximum continuous junction temperature.
P _{TOTAL}	= Total device power dissipation.
R _{qJA}	= Thermal resistance from junction to ambient.
T _{AMAX}	= Maximum ambient temperature.

The maximum power dissipation capability for a package can be calculated given the junction-to-ambient thermal resistance and the maximum ambient temperature for the application. The following equation can be used to determine the package maximum internal power dissipation.

EQUATION 6-3:

$$P_{D(MAX)} = \frac{(T_{J(MAX)} - T_{A(MAX)})}{R\theta_{JA}}$$

Where:

P _{D(MAX)}	= Maximum device power dissipation.
T _{J(MAX)}	= Maximum continuous junction temperature.
T _{A(MAX)}	= Maximum ambient temperature.
R _{qJA}	= Thermal resistance from junction to ambient.

EQUATION 6-4:

$$T_{J(RISE)} = P_{D(MAX)} \times R\theta_{JA}$$

Where:

T _{J(RISE)}	= Rise in device junction temperature over the ambient temperature.
P _{TOTAL}	= Maximum device power dissipation.
R _{qJA}	= Thermal resistance from junction to ambient.

EQUATION 6-5:

$$T_J = T_{J(RISE)} + T_A$$

Where:

T _J	= Junction Temperature.
T _{J(RISE)}	= Rise in device junction temperature over the ambient temperature.
T _A	= Ambient temperature.

MCP1804

6.3 Voltage Regulator

Internal power dissipation, junction temperature rise, junction temperature and maximum power dissipation are calculated in the following example. The power dissipation, as a result of ground current, is small enough to be neglected.

6.3.1 POWER DISSIPATION EXAMPLE

Package:	
Package Type =	SOT-25
Input Voltage:	
V _{IN} =	3.8V to 4.6V
LDO Output Voltages and Currents:	
V _{OUT} =	1.8V
I _{OUT} =	50 mA
Maximum Ambient Temperature:	
T _{A(MAX)} =	+40°C
Internal Power Dissipation:	
Internal Power dissipation is the product of the LDO output current times the voltage across the LDO (V _{IN} to V _{OUT}).	
P _{LDO(MAX)} =	(V _{IN(MAX)} - V _{OUT(MIN)}) x I _{OUT(MAX)}
P _{LDO} =	(4.6V - (0.98 x 1.8V)) x 50 mA
P _{LDO} =	141.8 milli-Watts

6.3.1.1 Device Junction Temperature Rise

The internal junction temperature rise is a function of internal power dissipation and the thermal resistance from junction to ambient for the application. The thermal resistance from junction to ambient (R_{θJA}) is derived from an EIA/JEDEC standard for measuring thermal resistance for small surface mount packages. The EIA/JEDEC specification is JESD51-7, "High Effective Thermal Conductivity Test Board for Leaded Surface Mount Packages". The standard describes the test method and board specifications for measuring the thermal resistance from junction to ambient. The actual thermal resistance for a particular application can vary depending on many factors, such as copper area and thickness. Refer to AN792, "A Method to Determine How Much Power a SOT23 Can Dissipate in an Application" (DS00792), for more information regarding this subject.

$$T_{J(RISE)} = P_{TOTAL} \times R_{qJA}$$

$$T_{JRISE} = 141.8 \text{ milli-Watts} \times 256.0^\circ\text{C/Watt}$$

$$T_{JRISE} = 36.3^\circ\text{C}$$

6.3.1.2 Junction Temperature Estimate

To estimate the internal junction temperature, the calculated temperature rise is added to the ambient or offset temperature. For this example, the worst-case junction temperature is estimated below.

$$T_J = T_{JRISE} + T_{A(MAX)}$$

$$T_J = 76.3^\circ\text{C}$$

Maximum Package Power Dissipation at +25°C Ambient Temperature (minimum PCB footprint)

SOT-25 (256°C/Watt = R _{θJA}):	
P _{D(MAX)} =	(85°C - 25°C) / 256°C/W
P _{D(MAX)} =	234 milli-Watts
SOT-89 (180°C/Watt = R _{θJA}):	
P _{D(MAX)} =	(85°C - 25°C) / 180°C/W
P _{D(MAX)} =	333 milli-Watts

6.4 Voltage Reference

The MCP1804 can be used not only as a regulator, but also as a low quiescent current voltage reference. In many microcontroller applications, the initial accuracy of the reference can be calibrated using production test equipment or by using a ratio measurement. When the initial accuracy is calibrated, the thermal stability and line regulation tolerance are the only errors introduced by the MCP1804 LDO. The low cost, low quiescent current and small ceramic output capacitor are all advantages when using the MCP1804 as a voltage reference.

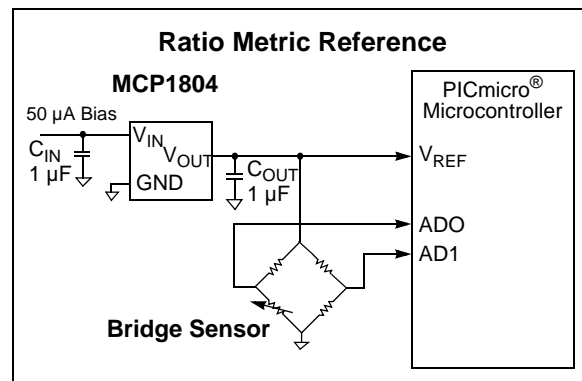

FIGURE 6-2: Using the MCP1804 as a voltage reference.

6.5 Pulsed Load Applications

For some applications, there are pulsed load current events that may exceed the specified 150 mA maximum specification of the MCP1804. The internal current limit of the MCP1804 will prevent high peak load demands from causing non-recoverable damage. The 150 mA rating is a maximum average continuous rating. As long as the average current does not exceed 150 mA nor the max power dissipation of the packaged device, pulsed higher load currents can be applied to the MCP1804. The typical current limit for the MCP1804 is 200 mA ($T_A = +25^\circ\text{C}$).

MCP1804

NOTES:

7.0 PACKAGING INFORMATION

7.1 Package Marking Information

5-Lead SOT-23

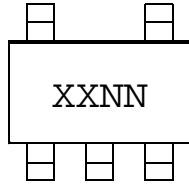

Part Number	Code
MCP1804T-1802I/OT	80KNN
MCP1804T-2502I/OT	80TNN
MCP1804T-3002I/OT	80ZNN
MCP1804T-3302I/OT	812NN
MCP1804T-5002I/OT	81MNN
MCP1804T-A002I/OT	839NN
MCP1804T-C002I/OT	83ZNN

Example:

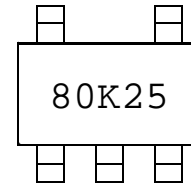

3-Lead SOT-89

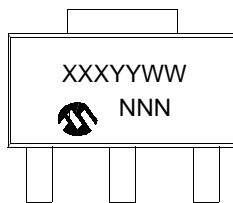

Part Number	Code
MCP1804T-1802I/MB	84KNN
MCP1804T-2502I/MB	84TNN
MCP1804T-3002I/MB	84ZNN
MCP1804T-3302I/MB	852NN
MCP1804T-5002I/MB	85MNN
MCP1804T-A002I/MB	879NN
MCP1804T-C002I/MB	87ZNN

Example:

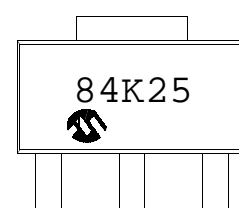

5-Lead SOT-89

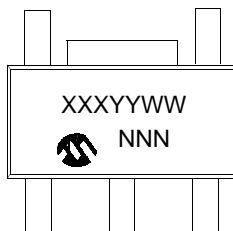

Part Number	Code
MCP1804T-1802I/MT	80KNN
MCP1804T-2502I/MT	80TNN
MCP1804T-3002I/MT	80ZNN
MCP1804T-3302I/MT	812NN
MCP1804T-5002I/MT	81MNN
MCP1804T-A002I/MT	839NN
MCP1804T-C002I/MT	83ZNN

Example:

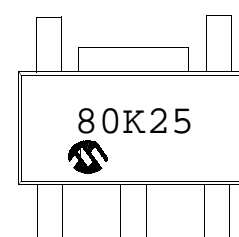

3-Lead SOT-223

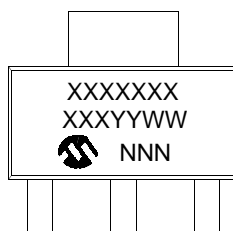

Part Number	Code
MCP1804T-1802I/DB	84KNN
MCP1804T-2502I/DB	84TNN
MCP1804T-3002I/DB	84ZNN
MCP1804T-3302I/DB	852NN
MCP1804T-5002I/DB	85MNN
MCP1804T-A002I/DB	879NN
MCP1804T-C002I/DB	87ZNN

Example:

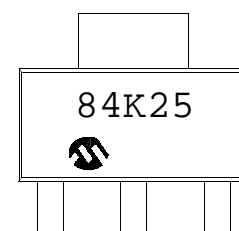

Legend:	XX...X	Customer-specific information
	Y	Year code (last digit of calendar year)
	YY	Year code (last 2 digits of calendar year)
	WW	Week code (week of January 1 is week '01')
	NNN	Alphanumeric traceability code
	(e3)	Pb-free JEDEC designator for Matte Tin (Sn)
	*	This package is Pb-free. The Pb-free JEDEC designator (e3) can be found on the outer packaging for this package.

Note: In the event the full Microchip part number cannot be marked on one line, it will be carried over to the next line, thus limiting the number of available characters for customer-specific information.

MCP1804

5-Lead Plastic Small Outline Transistor (OT) [SOT-23]

Note: For the most current package drawings, please see the Microchip Packaging Specification located at <http://www.microchip.com/packaging>

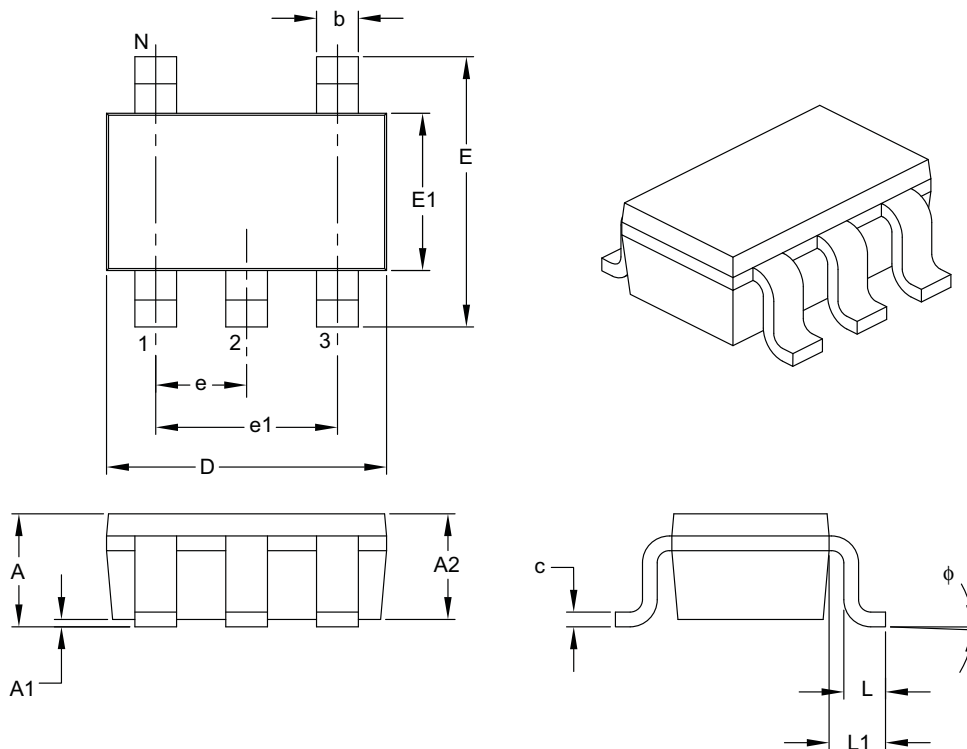

Dimension Limits	Units	MILLIMETERS		
		MIN	NOM	MAX
Number of Pins	N	5		
Lead Pitch	e	0.95 BSC		
Outside Lead Pitch	e1	1.90 BSC		
Overall Height	A	0.90	–	1.45
Molded Package Thickness	A2	0.89	–	1.30
Standoff	A1	0.00	–	0.15
Overall Width	E	2.20	–	3.20
Molded Package Width	E1	1.30	–	1.80
Overall Length	D	2.70	–	3.10
Foot Length	L	0.10	–	0.60
Footprint	L1	0.35	–	0.80
Foot Angle	ϕ	0°	–	30°
Lead Thickness	c	0.08	–	0.26
Lead Width	b	0.20	–	0.51

Notes:

- Dimensions D and E1 do not include mold flash or protrusions. Mold flash or protrusions shall not exceed 0.127 mm per side.
- Dimensioning and tolerancing per ASME Y14.5M.

BSC: Basic Dimension. Theoretically exact value shown without tolerances.

Microchip Technology Drawing C04-091B

3-Lead Plastic Small Outline Transistor Header (MB) [SOT-89]

Note: For the most current package drawings, please see the Microchip Packaging Specification located at <http://www.microchip.com/packaging>

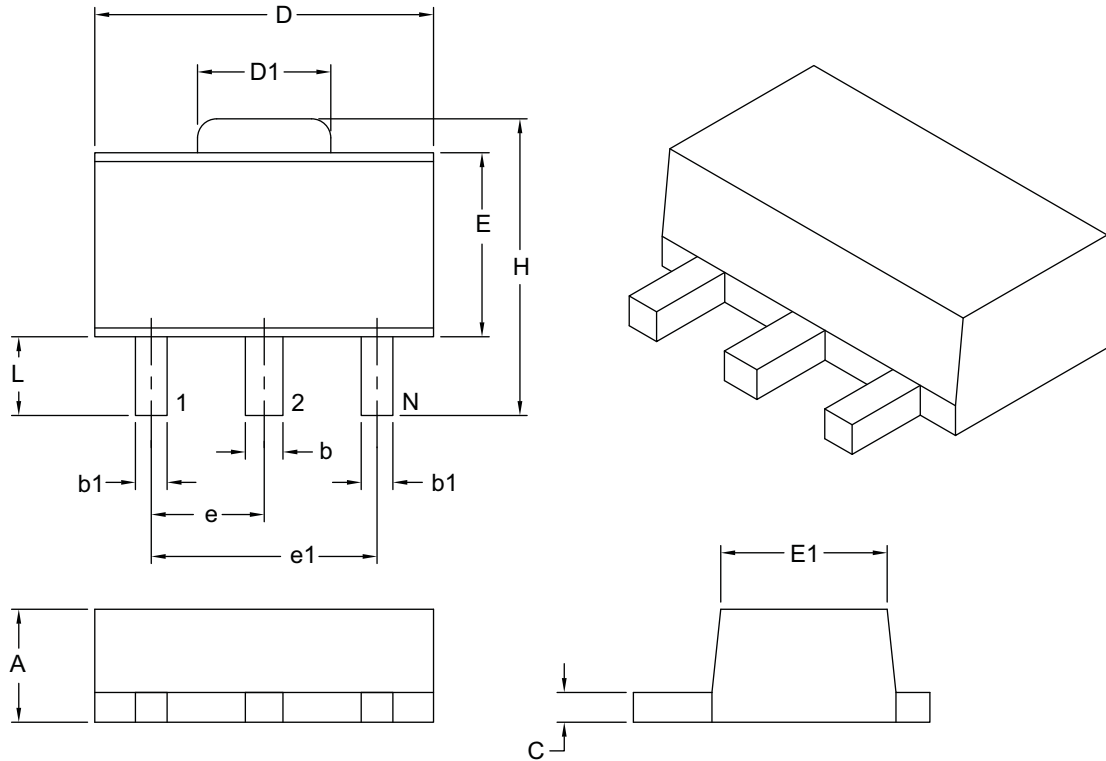

Dimension Limits	Units	MILLIMETERS	
		MIN	MAX
Number of Leads	N	3	
Pitch	e	1.50 BSC	
Outside Lead Pitch	e1	3.00 BSC	
Overall Height	A	1.40	1.60
Overall Width	H	3.94	4.25
Molded Package Width at Base	E	2.29	2.60
Molded Package Width at Top	E1	2.13	2.29
Overall Length	D	4.39	4.60
Tab Length	D1	1.40	1.83
Foot Length	L	0.79	1.20
Lead Thickness	c	0.35	0.44
Lead 2 Width	b	0.41	0.56
Leads 1 & 3 Width	b1	0.36	0.48

Notes:

- Dimensions D and E do not include mold flash or protrusions. Mold flash or protrusions shall not exceed 0.127 mm per side.
- Dimensioning and tolerancing per ASME Y14.5M.
BSC: Basic Dimension. Theoretically exact value shown without tolerances.

Microchip Technology Drawing C04-029B

MCP1804

5-Lead Plastic Small Outline Transistor Header (MT) [SOT-89]

Note: For the most current package drawings, please see the Microchip Packaging Specification located at <http://www.microchip.com/packaging>

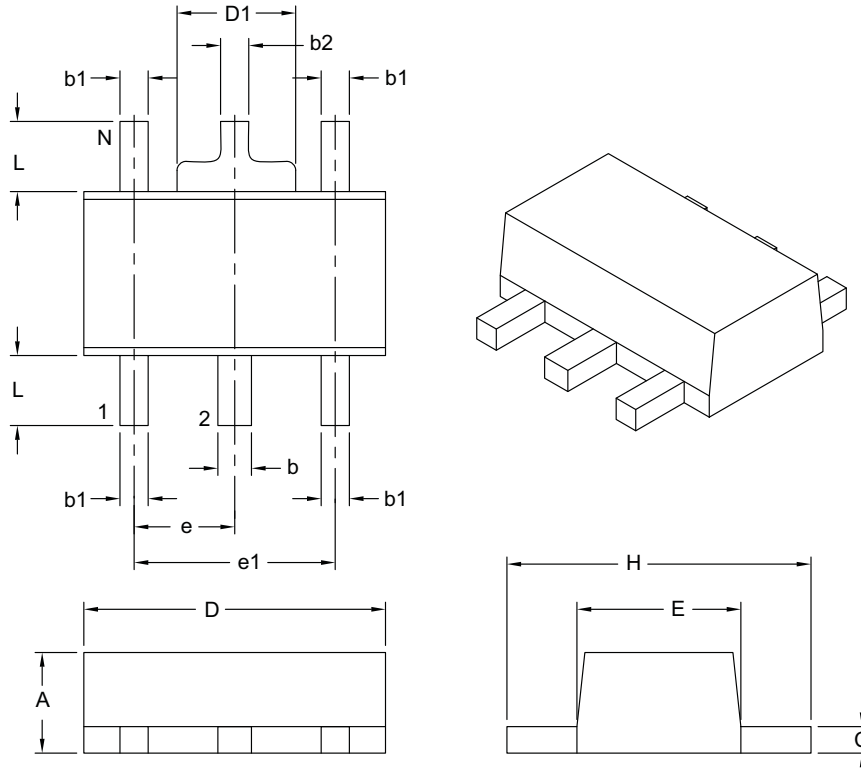

Dimension Limits	Units	MILLIMETERS	
		MIN	MAX
Number of Leads	N	5	
Lead Pitch	e	1.50 BSC	
Outside Lead Pitch	e1	3.00 BSC	
Overall Height	A	1.40	1.60
Overall Width	H	3.94	4.50
Molded Package Width	E	2.29	2.60
Overall Length	D	4.40	4.60
Tab Width	D1	1.40	1.83
Foot Length	L	0.80	1.20
Lead Thickness	c	0.35	0.44
Lead 2 Width	b	0.41	0.56
Leads 1, 3, 4 & 5 Width	b1	0.36	0.48
Tab Lead Width	b2	0.32	0.48

Notes:

- Dimensions D and E do not include mold flash or protrusions. Mold flash or protrusions shall not exceed 0.127 mm per side.
- Dimensioning and tolerancing per ASME Y14.5M.

BSC: Basic Dimension. Theoretically exact value shown without tolerances.

Microchip Technology Drawing C04-030B

3-Lead Plastic Small Outline Transistor (DB) [SOT-223]

Note: For the most current package drawings, please see the Microchip Packaging Specification located at <http://www.microchip.com/packaging>

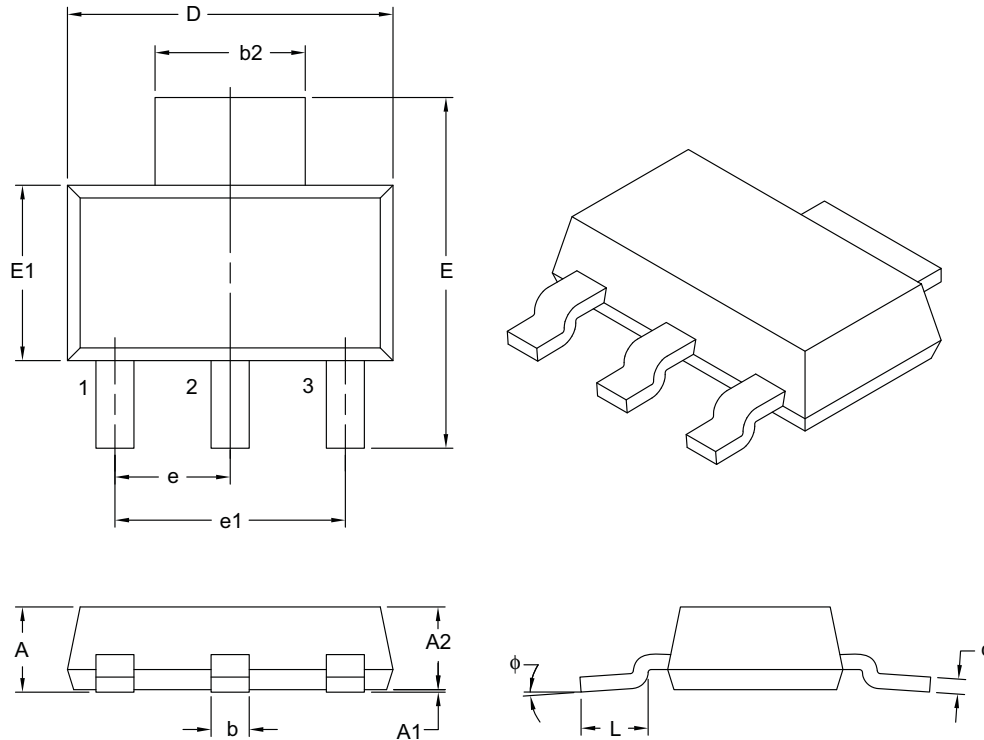

Dimension Limits	Units	MILLIMETERS		
		MIN	NOM	MAX
Number of Leads	N	3		
Lead Pitch	e	2.30 BSC		
Outside Lead Pitch	e1	4.60 BSC		
Overall Height	A	–	–	1.80
Standoff	A1	0.02	–	0.10
Molded Package Height	A2	1.50	1.60	1.70
Overall Width	E	6.70	7.00	7.30
Molded Package Width	E1	3.30	3.50	3.70
Overall Length	D	6.30	6.50	6.70
Lead Thickness	c	0.23	0.30	0.35
Lead Width	b	0.60	0.76	0.84
Tab Lead Width	b2	2.90	3.00	3.10
Foot Length	L	0.75	–	–
Lead Angle	ϕ	0°	–	10°

Notes:

- Dimensions D and E1 do not include mold flash or protrusions. Mold flash or protrusions shall not exceed 0.127 mm per side.
- Dimensioning and tolerancing per ASME Y14.5M.

BSC: Basic Dimension. Theoretically exact value shown without tolerances.

Microchip Technology Drawing C04-032B

MCP1804

3-Lead Plastic Small Outline Transistor (DB) [SOT-223]

Note: For the most current package drawings, please see the Microchip Packaging Specification located at <http://www.microchip.com/packaging>

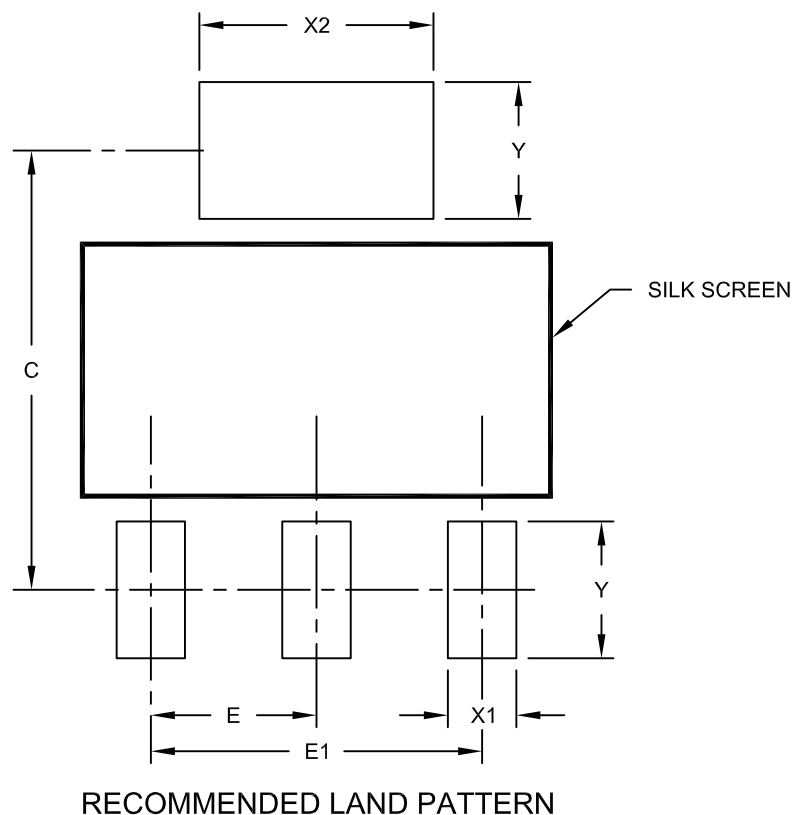

Dimension Limits	Units	MILLIMETERS		
		MIN	NOM	MAX
Contact Pitch	E	2.30 BSC		
Overall Pitch	E1	4.60 BSC		
Contact Pad Spacing	C		6.10	
Contact Pad Width	X1			0.95
Contact Pad Width	X2			3.25
Contact Pad Length	Y			1.90

Notes:

1. Dimensioning and tolerancing per ASME Y14.5M

BSC: Basic Dimension. Theoretically exact value shown without tolerances.

Microchip Technology Drawing No. C04-2032A

APPENDIX A: REVISION HISTORY

Revision A (September 2009)

- Original Release of this Document.

MCP1804

NOTES:

PRODUCT IDENTIFICATION SYSTEM

To order or obtain information, e.g., on pricing or delivery, refer to the factory or the listed sales office.

PART NO.	I	-XX	XX	X	XX	Examples:
Device	Tape and Reel	Voltage	Output Voltage Tolerance	Temperature Range	Package	
Device	MCP1804T:	LDO Voltage Regulator (Tape and Reel)				a) MCP1804T-1802I/OT: 1.8V, 5-LD SOT-23
Voltage Options	18 = 1.8V 25 = 2.5V 30 = 3.0V 33 = 3.3V 50 = 5.0V A0 = 10V C0 = 12V					b) MCP1804T-2502I/OT: 2.5V, 5-LD SOT-23
Output Voltage Tolerance	02 = ±2%					c) MCP1804T-3002I/OT: 3.0V, 5-LD SOT-23
Temperature Range	I = -40°C to +85°C (Industrial)					d) MCP1804T-3302I/OT: 3.3V, 5-LD SOT-23
Package	DB = 3-lead Plastic Small Outline Transistor (SOT-223) MB = 3-lead Plastic Small Outline Transistor (SOT-89) MT = 5-lead Plastic Small Outline Transistor (SOT-89) OT = 5-lead Plastic Small Outline Transistor (SOT-23)					e) MCP1804T-5002I/OT: 5.0V, 5-LD SOT-23
						f) MCP1804T-A002I/OT: 10V, 5-LD SOT-23
						g) MCP1804T-C002I/OT: 12V, 5-LD SOT-23
						a) MCP1804T-1802I/MB: 1.8V, 5-LD SOT-89
						b) MCP1804T-2502I/MB: 2.5V, 5-LD SOT-89
						c) MCP1804T-3002I/MB: 3.0V, 5-LD SOT-89
						d) MCP1804T-3302I/MB: 3.3V, 5-LD SOT-89
						e) MCP1804T-5002I/MB: 5.0V, 5-LD SOT-89
						f) MCP1804T-A002I/MB: 10V, 5-LD SOT-89
						g) MCP1804T-C002I/MB: 12V, 5-LD SOT-89
						a) MCP1804T-1802I/MT: 1.8V, 5-LD SOT-89
						b) MCP1804T-2502I/MT: 2.5V, 5-LD SOT-89
						c) MCP1804T-3002I/MT: 3.0V, 5-LD SOT-89
						d) MCP1804T-3302I/MT: 3.3V, 5-LD SOT-89
						e) MCP1804T-5002I/MT: 5.0V, 5-LD SOT-89
						f) MCP1804T-A002I/MT: 10V, 5-LD SOT-89
						g) MCP1804T-C002I/MT: 12V, 5-LD SOT-89
						a) MCP1804T-1802I/DB: 1.8V, 3-LD SOT-223
						b) MCP1804T-2502I/DB: 2.5V, 3-LD SOT-223
						c) MCP1804T-3002I/DB: 3.0V, 3-LD SOT-223
						d) MCP1804T-3302I/DB: 3.3V, 3-LD SOT-223
						e) MCP1804T-5002I/DB: 5.0V, 3-LD SOT-223
						f) MCP1804T-A002I/DB: 10V, 3-LD SOT-223
						g) MCP1804T-C002I/DB: 12V, 3-LD SOT-223

MCP1804

NOTES:

Note the following details of the code protection feature on Microchip devices:

- Microchip products meet the specification contained in their particular Microchip Data Sheet.
- Microchip believes that its family of products is one of the most secure families of its kind on the market today, when used in the intended manner and under normal conditions.
- There are dishonest and possibly illegal methods used to breach the code protection feature. All of these methods, to our knowledge, require using the Microchip products in a manner outside the operating specifications contained in Microchip's Data Sheets. Most likely, the person doing so is engaged in theft of intellectual property.
- Microchip is willing to work with the customer who is concerned about the integrity of their code.
- Neither Microchip nor any other semiconductor manufacturer can guarantee the security of their code. Code protection does not mean that we are guaranteeing the product as “unbreakable.”

Code protection is constantly evolving. We at Microchip are committed to continuously improving the code protection features of our products. Attempts to break Microchip's code protection feature may be a violation of the Digital Millennium Copyright Act. If such acts allow unauthorized access to your software or other copyrighted work, you may have a right to sue for relief under that Act.

Information contained in this publication regarding device applications and the like is provided only for your convenience and may be superseded by updates. It is your responsibility to ensure that your application meets with your specifications. MICROCHIP MAKES NO REPRESENTATIONS OR WARRANTIES OF ANY KIND WHETHER EXPRESS OR IMPLIED, WRITTEN OR ORAL, STATUTORY OR OTHERWISE, RELATED TO THE INFORMATION, INCLUDING BUT NOT LIMITED TO ITS CONDITION, QUALITY, PERFORMANCE, MERCHANTABILITY OR FITNESS FOR PURPOSE. Microchip disclaims all liability arising from this information and its use. Use of Microchip devices in life support and/or safety applications is entirely at the buyer's risk, and the buyer agrees to defend, indemnify and hold harmless Microchip from any and all damages, claims, suits, or expenses resulting from such use. No licenses are conveyed, implicitly or otherwise, under any Microchip intellectual property rights.

Trademarks

The Microchip name and logo, the Microchip logo, dsPIC, KEELOQ, KEELOQ logo, MPLAB, PIC, PICmicro, PICSTART, rfPIC and UNI/O are registered trademarks of Microchip Technology Incorporated in the U.S.A. and other countries.

FilterLab, Hampshire, HI-TECH C, Linear Active Thermistor, MXDEV, MXLAB, SEEVAL and The Embedded Control Solutions Company are registered trademarks of Microchip Technology Incorporated in the U.S.A.

Analog-for-the-Digital Age, Application Maestro, CodeGuard, dsPICDEM, dsPICDEM.net, dsPICworks, dsSPEAK, ECAN, ECONOMONITOR, FanSense, HI-TIDE, In-Circuit Serial Programming, ICSP, Mindi, MiWi, MPASM, MPLAB Certified logo, MPLIB, MPLINK, mTouch, Octopus, Omniscient Code Generation, PICC, PICC-18, PICDEM, PICDEM.net, PICkit, PICtail, PIC³² logo, REAL ICE, rLAB, Select Mode, Total Endurance, TSHARC, UniWinDriver, WiperLock and ZENA are trademarks of Microchip Technology Incorporated in the U.S.A. and other countries.

SQTP is a service mark of Microchip Technology Incorporated in the U.S.A.

All other trademarks mentioned herein are property of their respective companies.

© 2009, Microchip Technology Incorporated, Printed in the U.S.A., All Rights Reserved.

 Printed on recycled paper.

QUALITY MANAGEMENT SYSTEM
CERTIFIED BY DNV
== ISO/TS 16949:2002 ==

Microchip received ISO/TS-16949:2002 certification for its worldwide headquarters, design and wafer fabrication facilities in Chandler and Tempe, Arizona; Gresham, Oregon and design centers in California and India. The Company's quality system processes and procedures are for its PIC[®] MCUs and dsPIC[®] DSCs, KEELOQ[®] code hopping devices, Serial EEPROMs, microperipherals, nonvolatile memory and analog products. In addition, Microchip's quality system for the design and manufacture of development systems is ISO 9001:2000 certified.



WORLDWIDE SALES AND SERVICE

AMERICAS

Corporate Office

2355 West Chandler Blvd.
Chandler, AZ 85224-6199
Tel: 480-792-7200
Fax: 480-792-7277
Technical Support:
<http://support.microchip.com>
Web Address:
www.microchip.com

Atlanta

Duluth, GA
Tel: 678-957-9614
Fax: 678-957-1455

Boston

Westborough, MA
Tel: 774-760-0087
Fax: 774-760-0088

Chicago

Itasca, IL
Tel: 630-285-0071
Fax: 630-285-0075

Cleveland

Independence, OH
Tel: 216-447-0464
Fax: 216-447-0643

Dallas

Addison, TX
Tel: 972-818-7423
Fax: 972-818-2924

Detroit

Farmington Hills, MI
Tel: 248-538-2250
Fax: 248-538-2260

Kokomo

Kokomo, IN
Tel: 765-864-8360
Fax: 765-864-8387

Los Angeles

Mission Viejo, CA
Tel: 949-462-9523
Fax: 949-462-9608

Santa Clara

Santa Clara, CA
Tel: 408-961-6444
Fax: 408-961-6445

Toronto

Mississauga, Ontario,
Canada
Tel: 905-673-0699
Fax: 905-673-6509

ASIA/PACIFIC

Asia Pacific Office

Suites 3707-14, 37th Floor
Tower 6, The Gateway
Harbour City, Kowloon
Hong Kong
Tel: 852-2401-1200
Fax: 852-2401-3431

Australia - Sydney

Tel: 61-2-9868-6733
Fax: 61-2-9868-6755

China - Beijing

Tel: 86-10-8528-2100
Fax: 86-10-8528-2104

China - Chengdu

Tel: 86-28-8665-5511
Fax: 86-28-8665-7889

China - Hong Kong SAR

Tel: 852-2401-1200
Fax: 852-2401-3431

China - Nanjing

Tel: 86-25-8473-2460
Fax: 86-25-8473-2470

China - Qingdao

Tel: 86-532-8502-7355
Fax: 86-532-8502-7205

China - Shanghai

Tel: 86-21-5407-5533
Fax: 86-21-5407-5066

China - Shenyang

Tel: 86-24-2334-2829
Fax: 86-24-2334-2393

China - Shenzhen

Tel: 86-755-8203-2660
Fax: 86-755-8203-1760

China - Wuhan

Tel: 86-27-5980-5300
Fax: 86-27-5980-5118

China - Xiamen

Tel: 86-592-2388138
Fax: 86-592-2388130

China - Xian

Tel: 86-29-8833-7252
Fax: 86-29-8833-7256

China - Zhuhai

Tel: 86-756-3210040
Fax: 86-756-3210049

ASIA/PACIFIC

India - Bangalore

Tel: 91-80-3090-4444
Fax: 91-80-3090-4080

India - New Delhi

Tel: 91-11-4160-8631
Fax: 91-11-4160-8632

India - Pune

Tel: 91-20-2566-1512
Fax: 91-20-2566-1513

Japan - Yokohama

Tel: 81-45-471- 6166
Fax: 81-45-471-6122

Korea - Daegu

Tel: 82-53-744-4301
Fax: 82-53-744-4302

Korea - Seoul

Tel: 82-2-554-7200
Fax: 82-2-558-5932 or
82-2-558-5934

Malaysia - Kuala Lumpur

Tel: 60-3-6201-9857
Fax: 60-3-6201-9859

Malaysia - Penang

Tel: 60-4-227-8870
Fax: 60-4-227-4068

Philippines - Manila

Tel: 63-2-634-9065
Fax: 63-2-634-9069

Singapore

Tel: 65-6334-8870
Fax: 65-6334-8850

Taiwan - Hsin Chu

Tel: 886-3-6578-300
Fax: 886-3-6578-370

Taiwan - Kaohsiung

Tel: 886-7-536-4818
Fax: 886-7-536-4803

Taiwan - Taipei

Tel: 886-2-2500-6610
Fax: 886-2-2508-0102

Thailand - Bangkok

Tel: 66-2-694-1351
Fax: 66-2-694-1350

EUROPE

Austria - Wels

Tel: 43-7242-2244-39
Fax: 43-7242-2244-393

Denmark - Copenhagen

Tel: 45-4450-2828
Fax: 45-4485-2829

France - Paris

Tel: 33-1-69-53-63-20
Fax: 33-1-69-30-90-79

Germany - Munich

Tel: 49-89-627-144-0
Fax: 49-89-627-144-44

Italy - Milan

Tel: 39-0331-742611
Fax: 39-0331-466781

Netherlands - Drunen

Tel: 31-416-690399
Fax: 31-416-690340

Spain - Madrid

Tel: 34-91-708-08-90
Fax: 34-91-708-08-91

UK - Wokingham

Tel: 44-118-921-5869
Fax: 44-118-921-5820

03/26/09