

CLP-320 Series

Color Laser Printer

User's Guide

imagine the possibilities

Thank you for purchasing a Samsung product.

SAMSUNG

copyright

© 2010 Samsung Electronics Co., Ltd. All rights reserved.

This user's guide is provided for information purposes only. All information included herein is subject to change without notice.

Samsung Electronics is not responsible for any direct or indirect damages, arising from or related to use of this user's guide.

- Samsung and the Samsung logo are trademarks of Samsung Electronics Co., Ltd.
- Microsoft, Windows, Windows XP, Windows Vista, Windows 7, and Windows Server 2008 R2 are either registered trademarks or trademarks of Microsoft Corporation.
- TrueType, LaserWriter, and Macintosh are trademarks of Apple Computer, Inc.
- All other brand or product names are trademarks of their respective companies or organizations.

Refer to the '**LICENSE.txt**' file in the provided CD-ROM for the open source license information.

REV. 4.00

contents

	19	About this user's guide
	21	Features of your new product
INTRODUCTION	23	Machine overview
23	23	Front view
24	24	Rear view
	25	Control panel overview
	26	Understanding the control panel
	26	Status/ Toner LEDs
	26	Wireless LED
	26	Introducing the useful buttons
	26	Print screen button
	27	Demo print button
	27	Cancel button
	27	WPS button
	27	Power button
GETTING STARTED	28	Setting up the hardware
28	28	Location
	28	Printing a demo page
	28	Supplied software
	29	System requirements
	29	Microsoft® Windows®
	29	Macintosh
	30	Linux
	30	Installing USB connected machine's driver
	30	Windows
	31	Macintosh
	32	Linux
	33	Sharing your machine locally
	33	Windows
	33	Macintosh
NETWORK SETUP (CLP-320N(K)/CLP-321N/CLP-325W(K)/CLP-326W ONLY)	34	Network environment
34	34	Introducing useful network programs
	34	SyncThru™ Web Service
	34	SyncThru™ Web Admin Service
	34	SetIP
	34	Using a wired network
	35	Printing network configuration report
	35	Setting IP address
	35	IPv4 configuration
	36	IPv6 configuration
	36	Restoring factory default settings using SyncThru™ Web Service
	37	Installing network connected machine's driver
	37	Windows
	38	Macintosh
	39	Linux
WIRELESS NETWORK SETUP (CLP-325W(K)/326W ONLY)	40	Getting started
40	40	Choosing your network connection
	40	Wireless network name and network key
	40	Choosing the wireless network installation type
	40	From the control panel

contents

	40	From the computer
	40	Setting a wireless network with the WPS button
	41	Setting a wireless network with the WPS button
	41	Setting a wireless network from the computer
	41	Setting a wireless network with USB cable
	46	Setting a wireless network with network cable
	48	Completing the installation
	48	Turning the Wi-Fi network on/off
	48	Troubleshooting
	48	Solving problems that might occur during setting up the wireless setting and installing the machine driver
	49	Solving other problems
BASIC SETUP	50	Altitude adjustment
	50	Setting the default tray and paper
	50	From your computer
	51	Using the power saving feature
	51	Changing font setting (CLP-320N(K)/CLP-321N/CLP-325W(K) /CLP-326W only)
	51	Setting the humidity mode
MEDIA AND TRAY	52	Selecting print media
	52	Guidelines for selecting the print media
	52	Media sizes supported in each mode
	53	Changing the tray size
	54	Loading paper in the tray
	54	In the tray
	55	Manual feeding in the tray
	56	Printing on special media
	57	Envelopes
	57	Transparencies
	57	Labels
	58	Card stock/Custom-sized paper
	58	Letterhead/Preprinted paper
	58	Recycled paper
	58	Glossy photo
	58	Matte photo
	58	Setting the paper size and type
	58	Using the output support
PRINTING	59	Introducing useful software program
	59	Samsung AnyWeb Print
	59	Samsung Easy Color Manager
	59	Printer driver features
	59	Printer driver
	59	Basic printing
	60	Canceling a print job
	60	Opening printing preferences
	60	Using a favorite setting
	61	Using help
	61	Using special print features
	61	Printing multiple pages on one sheet of paper
	61	Printing posters
	61	Printing booklets (Manual)

contents

- 62 Printing on both sides of the paper (Manual)
- 62 Change percentage of your document
- 62 Fitting your document to a selected paper size
- 62 Using watermarks
- 63 Using overlay
- 63 Graphics tab options
- 64 Changing the default print settings**
- 64 Setting your machine as a default machine**
- 65 Printing to a file (PRN)**
- 65 Macintosh printing**
 - 65 Printing a document
 - 65 Changing printer settings
 - 66 Printing multiple pages on one sheet of paper
- 66 Linux printing**
 - 66 Printing from applications
 - 67 Printing files
 - 67 Configuring printer properties

MANAGEMENT TOOLS

68

- 68 Introducing useful management tools**
- 68 Using SyncThru™ Web Service**
 - 68 To access SyncThru™ Web Service
 - 68 SyncThru™ Web Service overview
 - 69 E-mail notification setup
 - 69 Setting the system administrator information
- 69 Using the Smart Panel program**
 - 69 Understanding Smart Panel
 - 70 Changing the Smart Panel Program Settings
- 70 Using the Unified Linux Driver Configurator**
 - 70 Opening the Unified Driver Configurator
 - 70 Printers configuration window
 - 71 Ports configuration

MAINTENANCE

72

- 72 Printing a machine report**
- 72 Cleaning a machine**
 - 72 Cleaning the outside
 - 72 Cleaning the inside
- 73 Storing the toner cartridge**
 - 73 Toner cartridge storage
 - 74 Handling instructions
 - 74 Use of non-Samsung and refilled toner cartridge
 - 74 Estimated cartridge life
- 74 Tips for moving & storing your machine**

TROUBLESHOOTING

75

- 75 Redistributing toner**
- 75 Tips for avoiding paper jams**
- 76 Clearing paper jams**
 - 76 In the tray
 - 76 Inside the machine
 - 76 In the paper exit area
- 78 Solving other problems**
 - 78 System problems
 - 78 Power problems
 - 79 Paper feeding problems
 - 80 Printing problems
 - 81 Printing quality problems

contents

- 84 Common Windows problems
- 84 Common Linux problems
- 85 Common Macintosh problems

SUPPLIES

86

- 86 How to purchase
- 86 Available supplies
- 86 Maintenance parts
- 86 Replacing the toner cartridge
- 87 Replacing the imaging unit
- 89 Replacing the waste toner container

SPECIFICATIONS

90

- 90 Hardware specifications
- 90 Environmental specifications
- 90 Electrical specifications
- 92 Print media specifications

CONTACT SAMSUNG WORLDWIDE

94

GLOSSARY

96

INDEX

102

safety information









These warnings and precautions are included to prevent injury to you and others, and to prevent any potential damage to your machine. Be sure to read and understand all of these instructions before using the machine.

Use common sense for operating any electrical appliance and whenever using your machine. Also, follow all warnings and instructions marked on the machine and in the accompanying literature. After reading this section, keep it in a safe place for future reference.

Important safety symbols

This section explains the meanings of all icons and signs in the user's guide. These safety symbols are in order, according to the degree of danger.

Explanation of all icons and signs used in the User's Guide:

	Warning	Hazards or unsafe practices that may result in severe personal injury or death.
	Caution	Hazards or unsafe practices that may result in minor personal injury or property damage.
		Do not attempt.
		Do not disassemble.
		Do not touch.
		Unplug the power cord from the wall socket.
		Make sure the machine is grounded to prevent electric shock.
		Call the service center for help.
		Follow directions explicitly.

Operating environment

Warning



Do not use if the power cord is damaged or if the electrical outlet is not grounded.

► This could result in electric shock or fire.



Do not bend, or place heavy objects on the power cord.

► Stepping on or allowing the power cord to be crushed by a heavy object could result in electric shock or fire.



Do not place anything on top of the machine (water, small metal or heavy objects, candles, lit cigarettes, etc.).

► This could result in electric shock or fire.



Do not remove the plug by pulling on the cord; do not handle the plug with wet hands.

► This could result in electric shock or fire.

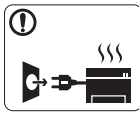

If the machine gets overheated, it releases smoke, makes strange noises, or generates an odd odor, immediately turn off the power switch and unplug the machine.

► This could result in electric shock or fire.

Caution

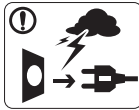



During an electrical storm or for a period of non-operation, remove the power plug from the electrical outlet.

► This could result in electric shock or fire.

-  Be careful, the paper output area is hot.
 - Burns could occur.

-  If the machine has been dropped, or if the cabinet appears damaged, unplug the machine from all interface connections and request assistance from qualified service personnel.
 - Otherwise, this could result in electric shock or fire.

-  If the machine exhibits a sudden and distinct change in performance, unplug the machine from all interface connections and request assistance from qualified service personnel.
 - Otherwise, this could result in electric shock or fire.

-  If the plug does not easily enter the electrical outlet, do not attempt to force it in.

► Call an electrician to change the electrical outlet, or this could result in electric shock.

-  Do not allow pets to chew on the AC power, telephone or PC interface cords.
 - This could result in electric shock or fire and/or injury to your pet.

-  If the machine does not operate properly after these instructions have been followed, unplug the machine from all interface connections and request assistance from qualified service personnel.
 - Otherwise, this could result in electric shock or fire.

Operating method

Caution





Do not forcefully pull the paper out during printing.

- It can cause damage to the machine.



Be careful not to put your hand between the machine and paper tray.

- You may get injured.

-  Do not block or push objects into the ventilation opening.
 - This could result in elevated component temperatures which can cause damage or fire.
-  Be care when replacing paper or removing jammed paper.
 - New paper has sharp edges and can cause painful cuts.





When printing large quantities, the bottom part of the paper output area may get hot. Do not allow children to touch.

► Burns can occur.



When removing jammed paper, do not use tweezers or sharp metal objects.

► It can damage the machine.

-  Do not allow too many papers to stack up in the paper output tray.
 - It can damage the machine.
-  This machine's power interception device is the power cord.
 - To switch off the power supply, remove the power cord from the electrical outlet.

Installation / Moving

Warning



Do not place the machine in an area with dust, humidity or water leaks.

- ▶ This could result in electric shock or fire.

Caution



Before moving the machine, turn the power off and disconnect all cords.

Then lift the machine:

- If the machine weighs under 20 kg (44.09lb), lift with 1 person.
- If the machine weighs 20 kg (44.09lb) - 40kg (88.18lb), lift with 2 people.
- If the machine weighs more than 40 kg (88.18lb), lift with 4 or more people.

- ▶ The machine could fall, causing injury or machine damage.

- ⓘ Do not place the machine on an unstable surface.
 - ▶ The machine could fall, causing injury or machine damage.
- ⓘ The machine should be connected to the power level which is specified on the label.
 - ▶ If you are unsure and want to check the power level you are using, contact the electrical utility company.
- ⓘ Use only No.26 AWG^a or larger, telephone line cord, if necessary.
 - ▶ Otherwise, it can cause damage to the machine.

- ⓘ Do not put a cover over the machine or place it in an airtight location, such as a closet.
 - ▶ If the machine is not well-ventilated, this could result in fire.

- ⓘ Make sure you plug the power cord into a grounded electrical outlet.
 - ▶ Otherwise, this could result in electric shock or fire.

- ⓘ Do not overload wall outlets and extension cords.
 - ▶ This can diminish performance, and could result in electric shock or fire.

- ⓘ Use the power cord supplied with your machine for safe operation. If you are using a cord which is longer than 2 meters (6 feet) with a 140V machine, then the gauge should be 16 AWG or larger.
 - ▶ Otherwise, it can cause damage to the machine, and could result in electric shock or fire.

a. AWG: American Wire Gauge

Maintenance / Checking

Caution



Unplug this product from the wall outlet before cleaning the inside of the machine. **Do not** clean the machine with benzene, paint thinner or alcohol; do not spray water directly into the machine.

- ▶ This could result in electric shock or fire.



Keep cleaning supplies away from children.

- ▶ Children could get hurt.



When you are working inside the machine replacing supplies or cleaning the inside, do not operate the machine.

▶ You could get injured.



Do not disassemble, repair or rebuild the machine by yourself.

▶ It can damage the machine. Call a certified technician when the machine needs repair.

ⓘ Keep the power cable and the contact surface of the plug clean from dust or water.

▶ Otherwise, this could result in electric shock or fire.

ⓘ To clean and operate the machine, strictly follow the user's guide provided with the machine.

▶ Otherwise, you could damage the machine.

⊘ Do not remove any covers or guards that are fastened with screws.

▶ The machine should only be repaired by a Samsung service technician.

Supply usage

Caution



Do not disassemble the toner cartridge.

▶ Toner dust can be dangerous if inhaled or ingested.



When storing supplies such as toner cartridges, keep them away from children.

▶ Toner dust can be dangerous if inhaled or ingested.



Do not burn any of the supplies such as toner cartridge or fuser unit.

▶ This could cause an explosion or uncontrollable fire.

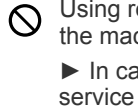

Using recycled supplies, such as toner, can cause damage to the machine.

▶ In case of damage due to the use of recycled supplies, a service fee will be charged.

ⓘ When changing the toner cartridge or removing jammed paper, be careful not to let toner dust touch your body or clothes.

▶ Toner dust can be dangerous if inhaled or ingested.

ⓘ When toner gets on your clothing, do not use hot water to wash it.

▶ Hot water sets toner into fabric. Use cold water.

regulatory information

This machine is designed for a normal work environment and certified with several regulatory statements.

Laser Safety Statement

The printer is certified in the U.S. to conform to the requirements of DHHS 21 CFR, chapter 1 Subchapter J for Class I(1) laser products, and elsewhere is certified as a Class I laser product conforming to the requirements of IEC 60825-1:1993 + A1:1997 + A2:2001.

Class I laser products are not considered to be hazardous. The laser system and printer are designed so there is never any human access to laser radiation above a Class I level during normal operation, user maintenance or prescribed service condition.

- **Wavelength:** 800 nm
- **Beam divergence**
 - **Paraller:** 12 degrees
 - **Perpendicular:** 30 degrees
- **Maximum power or energy output:** 5 mW

WARNING

Never operate or service the printer with the protective cover removed from Laser/Scanner assembly. The reflected beam, although invisible, can damage your eyes.

When using this product, these basic safety precautions should always be followed to reduce risk of fire, electric shock, and injury to persons:



Ozone Safety



During normal operation, this machine produces ozone. The ozone produced does not present a hazard to the operator. However, it is advisable that the machine be operated in a well ventilated area.

If you need additional information about ozone, contact your local Samsung dealer.

Power Saver



This printer contains advanced energy conservation technology that reduces power consumption when it is not in active use. When the printer does not receive data for an extended period of time, power consumption is automatically lowered. ENERGY STAR and the ENERGY STAR mark are registered U.S. marks. For more information on the ENERGY STAR program see <http://www.energystar.gov>.

Recycling



Recycle or dispose of the packaging material for this product in an environmentally responsible manner.

China only

回收和再循环

为了保护环境，我公司已经为废弃的产品建立了回收和再循环系统。我们会为您无偿提供回收同类废旧产品的服务。当您要废弃您正在使用的产品时，请您及时与工厂取得联系，我们会及时为您提供服务。

Correct Disposal of This Product (Waste Electrical & Electronic Equipment)



(Applicable in the European Union and other European countries with separate collection systems)

This marking shown on the product, accessories or literature indicates that the product and its electronic accessories (e.g. charger, headset, USB cable) should not be disposed of with other household wastes at the end of its working life. To prevent possible harm to the environment or human health from uncontrolled waste disposal, separate this from other types of wastes and recycle it responsibly to promote the sustainable reuse of material resources.

Household users should contact either the retailer where they purchased this product, or their local government office, for details of where and how they can take this item for environmentally safe recycling.

Business users should contact their supplier and check the terms and conditions of the purchase contract. This product should not be mixed with other commercial wastes for disposal.

Radio Frequency Emissions

FCC Information to the User

This device complies with Part 15 of the FCC Rules. Operation is subject to the following two conditions:

- This device may not cause harmful interference, and
- This device must accept any interference received, including interference that may cause undesired operation.

This equipment has been tested and found to comply with the limits for a Class B digital device, pursuant to Part 15 of the FCC Rules. These limits are designed to provide reasonable protection against harmful interference in a residential installation. This equipment generates, uses and can radiate radio frequency energy and, if not installed and used in accordance with the instructions, may cause harmful interference to radio communications. However, there is no guarantee that interference will not occur in a particular installation. If this equipment does cause harmful interference to radio or television reception, which can be determined by turning the equipment off and on, the user is encouraged to try to correct the interference by one or more of the following measures:

- Reorient or relocate the receiving antenna.
- Increase the separation between the equipment and receiver.
- Connect the equipment into an outlet on a circuit different from that to which the receiver is connected.
- Consult the dealer or experienced radio TV technician for help.

 Change or modifications not expressly approved by the manufacturer responsible for compliance could void the user's authority to operate the equipment.

Canadian Radio Interference Regulations

This digital apparatus does not exceed the Class B limits for radio noise emissions from digital apparatus as set out in the interference-causing equipment standard entitled "Digital Apparatus", ICES-003 of the Industry and Science Canada.

Cet appareil numérique respecte les limites de bruits radioélectriques applicables aux appareils numériques de Classe B prescrites dans la norme sur le matériel brouilleur: "Appareils Numériques", ICES-003 édictée par l'Industrie et Sciences Canada.

United states of america

Federal Communications Commission (FCC)

Intentional emitter per FCC Part 15

Low power, Radio LAN type devices (radio frequency (RF) wireless communication devices), operating in the 2.4 GHz/5 GHz Band, may be present (embedded) in your printer system. This section is only applicable if these devices are present. Refer to the system label to verify the presence of wireless devices.

Wireless devices that may be in your system are only qualified for use in the United States of America if an FCC ID number is on the system label.

The FCC has set a general guideline of 20 cm (8 inches) separation between the device and the body, for use of a wireless device near the body (this does not include extremities). This device should be used more than 20 cm (8 inches) from the body when wireless devices are on. The power output of the wireless device (or devices), which may be embedded in your printer, is well below the RF exposure limits as set by the FCC.

This transmitter must not be collocated or operation in conjunction with any other antenna or transmitter.

Operation of this device is subject to the following two conditions: (1) This device may not cause harmful interference, and (2) this device must accept any interference received, including interference that may cause undesired operation of the device.

 Wireless devices are not user serviceable. Do not modify them in any way. Modification to a wireless device will void the authorization to use it. Contact manufacturer for service.

FCC Statement for Wireless LAN use:

 While installing and operating this transmitter and antenna combination the radio frequency exposure limit of 1m W/cm² may be exceeded at distances close to the antenna installed. Therefore, the user must maintain a minimum distance of 20cm from the antenna at all times. This device cannot be collocated with another transmitter and transmitting antenna.

Turkey only

• RoHS

EEE Yönetmeliğine Uygundur.
This EEE is compliant with RoHS.

- Bu ürünün ortalama yaşam süresi 7 yıl, garanti süresi 2 yıldır.

Russia only



Germany only

Das Gerät ist nicht für die Benutzung am Bildschirmarbeitsplatz gemäß Bildschirmarbeitsverordnung vorgesehen.

Replacing the Fitted Plug (for UK Only)

Important

The mains lead for this machine is fitted with a standard (BS 1363) 13 amp plug and has a 13 amp fuse. When you change or examine the fuse, you must re-fit the correct 13 amp fuse. You then need to replace the fuse cover. If you have lost the fuse cover, do not use the plug until you have another fuse cover.

Contact the people from you purchased the machine.

The 13 amp plug is the most widely used type in the UK and should be suitable. However, some buildings (mainly old ones) do not have normal 13 amp plug sockets. You need to buy a suitable plug adaptor. Do not remove the moulded plug.



If you cut off the moulded plug, get rid of it straight away.

You cannot rewire the plug and you may receive an electric shock if you plug it into a socket.

Important warning:



You must earth this machine.

The wires in the mains lead have the following color code:

- **Green and Yellow:** Earth
- **Blue:** Neutral
- **Brown:** Live

If the wires in the mains lead do not match the colors marked in your plug, do the following:

You must connect the green and yellow wire to the pin marked by the letter "E" or by the safety 'Earth symbol' or colored green and yellow or green.

You must connect the blue wire to the pin which is marked with the letter "N" or colored black.

You must connect the brown wire to the pin which is marked with the letter "L" or colored red.

You must have a 13 amp fuse in the plug, adaptor, or at the distribution board.

Declaration of Conformity (European Countries)

Approvals and Certifications



The CE marking applied to this product symbolizes Samsung Electronics Co., Ltd. Declaration of Conformity with the following applicable 93/68/EEC Directives of the European Union as of the dates indicated:

CLP-320 Series: Low Voltage Directive (2006/95/EC), EMC Directive (2004/108/EC)

CLP-325W(K): R&TTE Directive (1999/5/EC)

The declaration of conformity may be consulted at www.samsung.com/printer, go to Support > Download center and enter your printer (MFP) name to browse the EuDoC.

January 1, 1995: Council Directive 2006/95/EC Approximation of the laws of the member states related to low voltage equipment.

January 1, 1996: Council Directive 2004/108/EC (92/31/EEC), approximation of the laws of the Member States related to electromagnetic compatibility.

March 9, 1999: Council Directive 1999/5/EC on radio equipment and telecommunications terminal equipment and the mutual recognition of their conformity. A full declaration, defining the relevant Directives and referenced standards can be obtained from your Samsung Electronics Co., Ltd. representative.

European Radio Approval Information (for products fitted with EU-approved radio devices)

Low power, Radio LAN type devices (radio frequency (RF) wireless communication devices), operating in the 2.4 GHz/5 GHz band, may be present (embedded) in your printer system which is intended for home or office use. This section is only applicable if these devices are present. Refer to the system label to verify the presence of wireless devices.

Wireless devices that may be in your system are only qualified for use in the European Union or associated areas if a CE mark with **CE** a Notified Body Registration Number and the Alert Symbol is on the system label.

The power output of the wireless device or devices that may be embedded in your printer is well below the RF exposure limits as set by the European Commission through the R&TTE directive.

European States qualified under wireless approvals:

EU

Austria, Belgium, Cyprus, Czech Republic, Denmark, Estonia, Finland, France (with frequency restrictions), Germany, Greece, Hungary, Ireland, Italy, Latvia, Lithuania, Luxembourg, Malta, The Netherlands, Poland, Portugal, Slovakia, Slovenia, Spain, Sweden and the U.K.

EEA/EFTA countries

Iceland, Liechtenstein, Norway and Switzerland

European States with restrictions on use:

EU

In France, the frequency range is restricted to 2446.5-2483.5 MHz for devices above 10 mW transmitting power such as wireless EEA/EFTA countries

No limitations at this time

Regulatory Compliance Statements

Wireless Guidance





Low power, Radio LAN type devices (radio frequency (RF) wireless communication devices), operating in the 2.4 GHz/5 GHz Band, may be present (embedded) in your printer system. The following section is a general overview of considerations while operating a wireless device. Additional limitations, cautions, and concerns for specific countries are listed in the specific country sections (or country group sections). The wireless devices in your system are only qualified for use in the countries identified by the Radio Approval Marks on the system rating label. If the country you will be using the wireless device in, is not listed, contact your local Radio Approval agency for requirements. Wireless devices are closely regulated and use may not be allowed.

The power output of the wireless device or devices that may be embedded in your printer is well below the RF exposure limits as known at this time. Because the wireless devices (which may be embedded into your printer) emit less energy than is allowed in radio frequency safety standards and recommendations, manufacturer believes these devices are safe for use. Regardless of the power levels, care should be taken to minimize human contact during normal operation.

As a general guideline, a separation of 20 cm (8 inches) between the wireless device and the body, for use of a wireless device near the body (this does not include extremities) is typical. This device should be used more than 20 cm (8 inches) from the body when wireless devices are on and transmitting.

This transmitter must not be collocated or operation in conjunction with any other antenna or transmitter.

Some circumstances require restrictions on wireless devices. Examples of common restrictions are listed below:

-  Radio frequency wireless communication can interfere with equipment on commercial aircraft. Current aviation regulations require wireless devices to be turned off while traveling in an airplane. IEEE 802.11 (also known as wireless Ethernet) and Bluetooth communication devices are examples of devices that provide wireless communication.
-  In environments where the risk of interference to other devices or services is harmful or perceived as harmful, the option to use a wireless device may be restricted or eliminated. Airports, Hospitals, and Oxygen or flammable gas laden atmospheres are limited examples where use of wireless devices may be restricted or eliminated. When in environments where you are uncertain of the sanction to use wireless devices, ask the applicable authority for authorization prior to use or turning on the wireless device.
-  Every country has different restrictions on the use of wireless devices. Since your system is equipped with a wireless device, when traveling between countries with your system, check with the local Radio Approval authorities prior to any move or trip for any restrictions on the use of a wireless device in the destination country.
-  If your system came equipped with an internal embedded wireless device, do not operate the wireless device unless all covers and shields are in place and the system is fully assembled.
-  Wireless devices are not user serviceable. Do not modify them in any way. Modification to a wireless device will void the authorization to use it. Contact manufacturer for service.



Only use drivers approved for the country in which the device will be used. See the manufacturer System Restoration Kit, or contact manufacturer Technical Support for additional information.

OpenSSL License

Copyright (c) 1998-2001 The OpenSSL Project. All rights reserved.

Redistribution and use in source and binary forms, with or without modification, are permitted provided that the following conditions are met:

1. Redistributions of source code must retain the above copyright notice, this list of conditions and the following disclaimer.
2. Redistributions in binary form must reproduce the above copyright notice, this list of conditions and the following disclaimer in the documentation and/or other materials provided with the distribution.
3. All advertising materials mentioning features or use of this software must display the following acknowledgment: "This product includes software developed by the OpenSSL Project for use in the OpenSSL Toolkit (<http://www.openssl.org/>)".
4. The names "OpenSSL Toolkit" and "OpenSSL Project" must not be used to endorse or promote products derived from this software without prior written permission. For written permission, please contact openssl-core@openssl.org.
5. Products derived from this software may not be called "OpenSSL" nor may "OpenSSL" appear in their names without prior written permission of the OpenSSL Project.
6. Redistributions of any form whatsoever must retain the following acknowledgment: "This product includes software developed by the OpenSSL Project for use in the OpenSSL Toolkit (<http://www.openssl.org/>)".

THIS SOFTWARE IS PROVIDED BY THE OpenSSL PROJECT "AS IS" AND ANY EXPRESSED OR IMPLIED WARRANTIES, INCLUDING, BUT NOT LIMITED TO, THE IMPLIED WARRANTIES OF MERCHANTABILITY AND FITNESS FOR A PARTICULAR PURPOSE ARE DISCLAIMED. IN NO EVENT SHALL THE OpenSSL PROJECT OR ITS CONTRIBUTORS BE LIABLE FOR ANY DIRECT, INDIRECT, INCIDENTAL, SPECIAL, EXEMPLARY, OR CONSEQUENTIAL DAMAGES (INCLUDING, BUT NOT LIMITED TO, PROCUREMENT OF SUBSTITUTE GOODS OR SERVICES; LOSS OF USE, DATA, OR PROFITS; OR BUSINESS INTERRUPTION) HOWEVER CAUSED AND ON ANY THEORY OF LIABILITY, WHETHER IN CONTRACT, STRICT LIABILITY, OR TORT (INCLUDING NEGLIGENCE OR OTHERWISE) ARISING IN ANY WAY OUT OF THE USE OF THIS SOFTWARE, EVEN IF ADVISED OF THE POSSIBILITY OF SUCH DAMAGE.

This product includes cryptographic software written by Eric Young (eay@cryptsoft.com). This product includes software written by Tim Hudson (tjh@cryptsoft.com).

Original SSLLeay License

Copyright (C) 1995-1998 Eric Young (eay@cryptsoft.com) All rights reserved.

This package is an SSL implementation written by Eric Young (eay@cryptsoft.com). The implementation was written so as to conform with Netscapes SSL.

This library is free for commercial and non-commercial use as long as the following conditions are adhered to. The following conditions apply to all code found in this distribution, be it the RC4, RSA, lhash, DES, etc., code; not just the SSL code. The SSL documentation included with this distribution is covered by the same copyright terms except that the holder is Tim Hudson (tjh@cryptsoft.com). Copyright remains Eric Young's, and as such any Copyright notices in the code are not to be removed. If this package is used in a product, Eric Young should be given attribution as the author of the parts of the library used. This can be in the form of a textual message at program startup or in documentation (online or textual) provided with the package.

Redistribution and use in source and binary forms, with or without modification, are permitted provided that the following conditions are met:

1. Redistributions of source code must retain the copyright notice, this list of conditions and the following disclaimer.
2. Redistributions in binary form must reproduce the above copyright notice, this list of conditions and the following disclaimer in the documentation and/or other materials provided with the distribution.
3. All advertising materials mentioning features or use of this software must display the following acknowledgement: "This product includes cryptographic software written by Eric Young (eay@cryptsoft.com)" The word 'cryptographic' can be left out if the routines from the library being used are not cryptographic related.
4. If you include any Windows specific code (or a derivative thereof) from the apps directory (application code) you must include an acknowledgement: "This product includes software written by Tim Hudson (tjh@cryptsoft.com)".

THIS SOFTWARE IS PROVIDED BY ERIC YOUNG "AS IS" AND ANY EXPRESS OR IMPLIED WARRANTIES, INCLUDING, BUT NOT LIMITED TO, THE IMPLIED WARRANTIES OF MERCHANTABILITY AND FITNESS FOR A PARTICULAR PURPOSE ARE DISCLAIMED. IN NO EVENT SHALL THE AUTHOR OR CONTRIBUTORS BE LIABLE FOR ANY DIRECT, INDIRECT, INCIDENTAL, SPECIAL, EXEMPLARY, OR CONSEQUENTIAL DAMAGES (INCLUDING, BUT NOT LIMITED TO, PROCUREMENT OF SUBSTITUTE GOODS OR SERVICES;

LOSS OF USE, DATA, OR PROFITS; OR BUSINESS INTERRUPTION) HOWEVER CAUSED AND ON ANY THEORY OF LIABILITY, WHETHER IN CONTRACT, STRICT LIABILITY, OR TORT (INCLUDING NEGLIGENCE OR OTHERWISE) ARISING IN ANY WAY OUT OF THE USE OF THIS SOFTWARE, EVEN IF ADVISED OF THE POSSIBILITY OF SUCH DAMAGE.

The licence and distribution terms for any publicly available version or derivative of this code cannot be changed. i.e. this code cannot simply be copied and put under another distribution licence [including the GNU Public Licence.

China only

产品中有毒有害物质或元素的名称及含量

部件名称	有毒有害物质或元素					
	铅 (Pb)	汞 (Hg)	镉 (Cd)	六价铬 (Cr ⁶⁺)	多溴联苯 (PBB)	多溴联苯醚 (PBDE)
塑料	○	○	○	○	○	○
金属 (机箱)	X	○	○	○	○	○
印刷电路部件 (PCA)	X	○	○	○	○	○
电缆 / 连接器	X	○	○	○	○	○
电源设备	X	○	○	○	○	○
电源线	X	○	○	○	○	○
机械部件	X	○	○	○	○	○
卡盒部件	X	○	○	○	○	○
定影部件	X	○	○	○	○	○
扫描仪部件 - CCD (如果有)	X	X	○	○	○	○
扫描仪部件 - 其它 (如果有)	X	○	○	○	○	○
印刷电路板部件 (PBA)	X	○	○	○	○	○
墨粉	○	○	○	○	○	○
滚筒	○	○	○	○	○	○

○：表示该有毒有害物质在该部件所有均质材料中的含量均在 SJ/T 11363-2006 标准规定的限量要求以下。

X：表示该有毒有害物质至少在该部件的某一均质材料中的含量超出 SJ/T 11363-2006 标准规定的限量要求。

以上表为目前本产品含有有毒有害物质的信息。本信息由本公司的配套厂家提供，经本公司审核后而做成，本产品的部分部件含有有毒有害物质，这些部件是在现有科学技术水平下暂时无可替代物质，但三星电子将会一直为满足 SJ/T 11363-2006 标准而做不懈的努力。

about this user's guide

This user's guide provides information about basic understanding of the machine as well as detailed explanation on each step during actual usage. It is a valuable resource for both novice and professional users for the proper installation and use of the machine.



-  •Read the safety information before using the machine.
- If you have a problem using the machine, refer to the troubleshooting chapter (See "Troubleshooting" on page 75).
- Terms used in this user's guide are explained in the glossary chapter (See "Glossary" on page 96).
- Illustrations in this user's guide may differ from your machine depending on its options or models.
- The procedures in this user's guide are mainly based on Windows XP.

Convention

Some terms in this guide are used interchangeably as below.



- Document is synonymous with original.
- Paper is synonymous with media or print media.
- Machine refers to printer or MFP.

The following table offers the conventions of this guide.

Convention	Description	Example
Bold	For texts on the display or button names on the machine.	Cancel
Note	Provides additional information or details for the machine function and feature.	 The date format may differ from country to country.
Caution	Contains information you can use to protect the machine from possible mechanical damage or malfunction.	 Do not touch the surface of the drum located in the toner cartridge or imaging unit.
Footnote	Provides additional information on certain words or a phrase.	a. pages per minute
(“Cross-reference”)	Refers you to additional detailed information.	(See "Finding more information" on page 20)

Finding more information

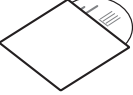
You can find information about setting up and using your machine in the following resources, either as a print-out or on screen.

Material name	Description
Quick Installation Guide 	This guide provides information on setting up your machine. This guide is provided in the box with the printer.
User's Guide 	This guide provides you with step-by-step instructions for using your machine's full features, maintaining your machine, troubleshooting, and replacing supplies.
Machine Driver Help 	This help provides you with help information about the printer driver and instructions for setting up the options for printing (See "Using help" on page 61).
Samsung website	If you have Internet access, you can get help, support, machine drivers, manuals and order information from the Samsung website, www.samsung.com/printer .
Downloadable software	You can download useful software programs from the Samsung website. <ul style="list-style-type: none">• SyncThru™ Web Admin Service: convenient for network administrators who need to manage many machines simultaneously. This program is for network model only. (http://solution.samsungprinter.com)• Samsung AnyWeb Print: helps personal users to screen-capture the website screen in Windows Internet Explorer easily. (http://solution.samsungprinter.com/personal/anywebprint)• Samsung Easy Color Manager: helps Samsung color laser printer users to adjust color as they like. (http://solution.samsungprinter.com/personal/colormanager)

features of your new product

Your new machine is equipped with a number of special features that improve the quality of the documents you print.

Special Features

Print with excellent quality and speed



- You can print in a full range of colors using cyan, magenta, yellow and black.
- You can print with a resolution of up to 2400 x 600 dpi effective output.
- Your machine prints A4-sized paper at up to 16 ppm and Letter-sized paper at up to 17 ppm in black and white mode and 4 ppm in color mode.

Handle many different types of printable material

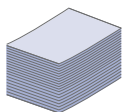

- The tray holds up to 150 sheet of plain paper in various sizes.
- You can load different custom-size print media in the tray.

Create professional documents (Windows only)

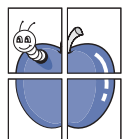

- Print Watermarks. You can customize your documents with words such as "Confidential" (See "Using watermarks" on page 62).
- Print Posters. The text and pictures of each page of your document are magnified and printed across the sheet of paper and can then be taped together to form a poster (See "Printing posters" on page 61).
- You can use preprinted forms and letterhead with plain paper (See "Using overlay" on page 63).

Save time and money

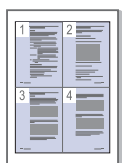

- To save paper, you can print multiple pages on one single sheet of paper (See "Printing multiple pages on one sheet of paper" on page 61).
- This machine automatically conserves electricity by substantially reducing power consumption when not in use.
- To save paper, you can print on both sides of the paper (Manual) (See "Printing on both sides of the paper (Manual)" on page 62).

Print in various environments



- You can print with Windows as well as Linux and Macintosh OS systems.
- Your machine is equipped with a Hi-Speed USB 2.0 interface.
- Your machine comes with a built-in network interface, Ethernet 10/100 BaseTX. (CLP-320N(K)/CLP-321N/CLP-325W(K)/CLP-326W only)
- Your machine comes with a built-in network Interface 802.11 b/g/n wireless LAN. (CLP-325W(K)/CLP-326W only)

IPv6 (CLP-320N(K)/CLP-321N/CLP-325W(K)/CLP-326W only)

The machine supports IPv6 (See "IPv6 configuration" on page 36).

Features by models

The machines are designed to support all of your document needs from printing to more advanced networking solutions for your business.

Some features and optional goods may not be available depending on models or countries.

Features by models include:

FEATURES	CLP-320(K) CLP-321 CLP-325(K) CLP-326	CLP-320N(K) CLP-321N	CLP-325W(K) CLP-326W
Hi-Speed USB 2.0	•	•	•
Network Interface Ethernet 10/100 BaseTX wired LAN		•	•
Network Interface 802.11 b/g/n wireless LAN^a			•
Duplex (2-sided) printing (Manual)	•	•	•

a. Depending on your country, wireless LAN cards may not be available. Contact your local Samsung dealer or the retailer where you bought your printer.

(•: Included, Blank: Not available)

introduction

This chapter gives you an overview of your machine.

This chapter includes:

- Machine overview
- Control panel overview
- Understanding the control panel

Machine overview

Front view

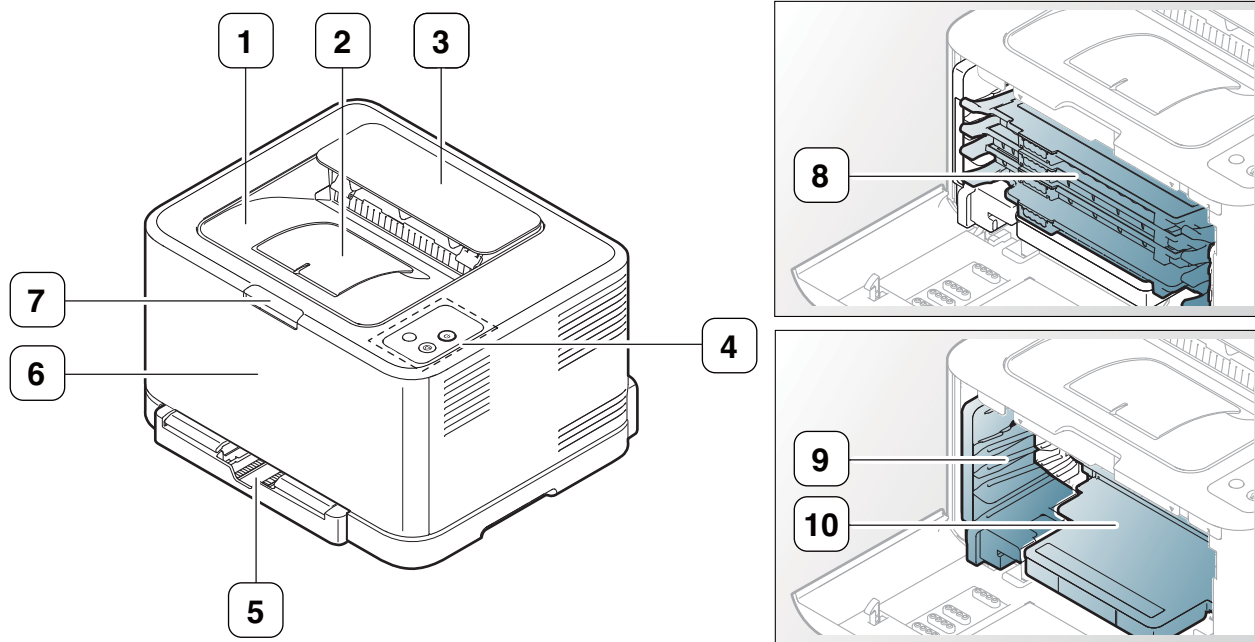

This illustration may differ from your machine depending on its model.

1	Output tray (face down)	6	Front cover
2	Output support	7	Front cover release button
3	Top cover	8	Toner cartridges
4	Control panel	9	Waster toner container
5	Tray	10	Imaging unit

Rear view

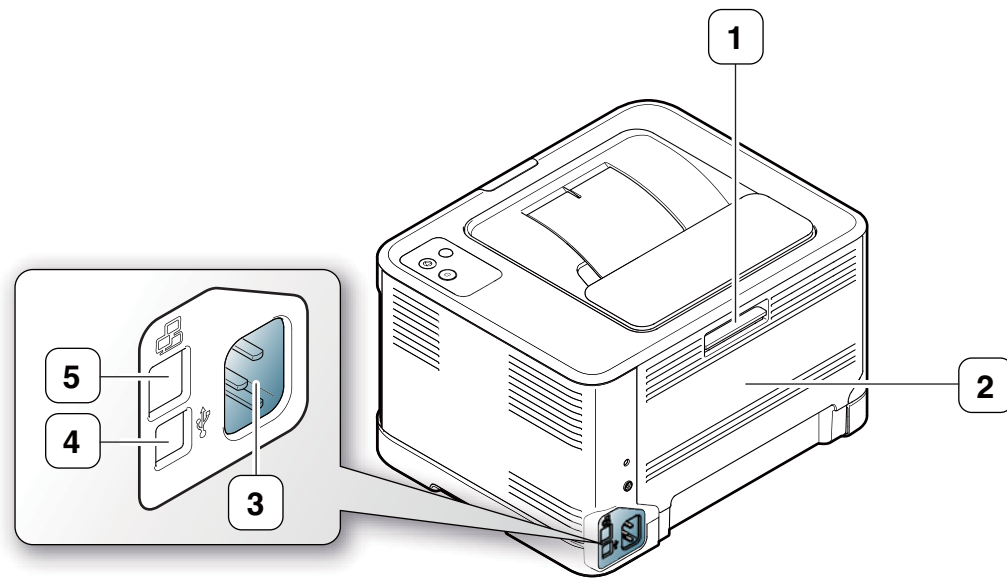

This illustration may differ from your machine depending on its model.

- | | | | |
|---|---------------------------|---|---------------------------|
| 1 | Rear cover release button | 4 | USB port |
| 2 | Rear cover | 5 | Network port ^a |
| 3 | Power receptacle | | |

a. CLP-320N(K)/CLP-321N only.

Control panel overview

This illustration may differ from your machine depending on its model.

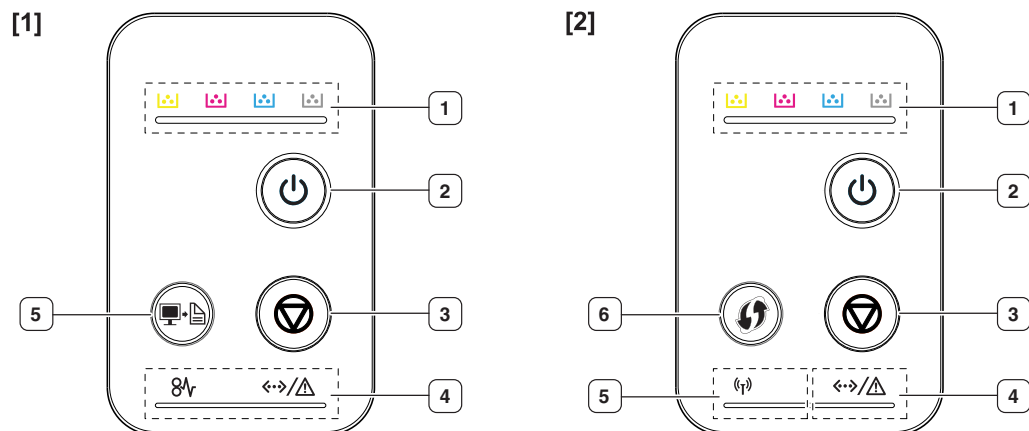

[1] CLP-320(K)/CLP-321/CLP-325(K)/ CLP-326/CLP-320N(K)/CLP-321N

1	Toner LEDs	Shows the status of each toner cartridge (See "Status/ Toner LEDs" on page 26).
2	Power button	You can turn the power on and off with this button (See "Power button" on page 27).
3	Cancel button	Stops an operation at any time and there are more functions (See "Cancel button" on page 27).
4	Status LED	Shows the status of your machine (See "Status/ Toner LEDs" on page 26).
5	Print Screen^a	Prints the displayed screen of your monitor (See "Print screen button" on page 26).
	Demo Print^b	Prints a demo page (See "Demo print button" on page 27).

a. CLP-320(K)/CLP-321/CLP-325(K)/ CLP-326 only.

b. CLP-320N(K)/CLP-321N only.

[2] CLP-325W(K)/CLP-326W

1	Toner LEDs	Shows the status of each toner cartridge (See "Status/ Toner LEDs" on page 26).
2	Power button	You can turn the power on and off with this button (See "Power button" on page 27).
3	Cancel button	Stops an operation at any time and there are more functions (See "Cancel button" on page 27).
4	Status LED	Shows the status of your machine (See "Status/ Toner LEDs" on page 26).
5	Wireless LED	Shows the status of wireless network. When the LED on, the machine is connected wirelessly (See "Wireless LED" on page 26).
6	WPS button	If your wireless access point supports WPS (Wi-Fi Protected Setup™), you can configure the wireless network connection easily without a computer (See "Setting a wireless network with the WPS button" on page 41).

Understanding the control panel

Status/ Toner LEDs

The color of the LEDs indicates the machine's current status.

LED	Status	Toner LEDs	Description	
Online/Error (↔/△)	Off	All LEDs off	The machine is off-line.	
	Solid green	All LEDs off	The machine is online and can receive data from a computer.	
	Slowly blinking green	All LEDs off	When the Status LED blinks green slowly, the machine is receiving data from a computer.	
	Quickly blinking green	All LEDs off	When the Status LED blinks green quickly, the machine is printing data.	
	Solid green	Corresponding LED blinks red	All LEDs off	Each toner cartridge is near the end of its life.
			Corresponding LED blinks red successively	The machine is warming up.
	Solid red	All LEDs off	Corresponding LED is solid red	<ul style="list-style-type: none"> The cover is open. Close the cover. There is no paper in the tray. Load paper in the tray. The machine has stopped due to a major error. The machine is experiencing system problems requiring service, such as LSU error, fuser error, or ITB error. Contact the service representative.
<ul style="list-style-type: none"> A toner cartridge has almost reached its estimated cartridge life^a. It is recommended to replace the toner cartridge (See "Replacing the toner cartridge" on page 86). The machine cannot recognize the status of toner cartridges and the supplies information. Open and close the cover and check if the machine can operate properly. If the problem persists, turn the power off and on. 				

LED	Status	Toner LEDs	Description
	Blinks red	Corresponding LED is solid red	<ul style="list-style-type: none"> A minor error has occurred and the machine is waiting for the error to be cleared. When the problem is cleared, the machine resumes. A small amount of toner is left in the cartridge. The estimated cartridge life^a of toner is close. Prepare a new cartridge for replacement. You may temporarily increase the printing quality by redistributing the toner in the cartridge (See "Redistributing toner" on page 75).
Jam (⚡)	Lights orange	All LEDs off	A paper jam has occurred (See "Clearing paper jams" on page 76).

a. Estimated cartridge life means the expected or estimated toner cartridge life, which indicates the average capacity of print-outs and is designed pursuant to ISO/IEC 19798. The number of pages may be affected by operating environment, printing interval, graphics, media type and media size. Some amount of toner may remain in the cartridge even when red LED is on and the printer stops printing.

 Samsung does not recommend using non-genuine Samsung toner cartridge such as one that is refilled or remanufactured. Samsung cannot guarantee a non-genuine Samsung toner cartridge's quality. Service or repair required as a result of using non-genuine Samsung toner cartridges will not be covered under the machine warranty.

 All printing errors will appear in the Smart Panel program window. If the problem persists, call for service (See "Using the Smart Panel program" on page 69).

Wireless LED

Wireless LED status		Description
Blue	Off (—)	Wireless network is disconnected.
	On (—)	Wireless network is connected.
	Slowly blinks (—)	The machine starts connecting to a wireless network.
	Quickly blinks (—)	<ul style="list-style-type: none"> The machine is connecting to access point (or wireless router). Wireless network connection is being disconnected.

Introducing the useful buttons

Print screen button

 (CLP-320(K)/CLP-321/CLP-325(K)/ CLP-326 only)

By pressing the **Print screen** () button, you can do the following functions.

Function	Description
Printing the active window	Press this button and the green LED will start blinking. When the green LED stops blinking, release the button.
Printing the whole monitor screen	Press this button and the green LED will start blinking. Release the button while it's blinking.

- The page will be printed on the default page like A4 or Letter.
- You can only use this function with a USB-connected machine.
- Print screen** can only be used with Windows and Macintosh operating systems.
- You can use this function only when the Smart Panel program is installed.

Demo print button

(CLP-320N(K)/CLP-321N only)

It prints a demo page by pressing this button only. The printed page shows the color print quality potential and overall print characteristics of the machine.

Cancel button



By pressing the **Cancel** (⊘) button, you can do the following functions.

Function	Description
Printing demo page (CLP-325W(K)/CLP-326W only)	In ready mode, press and hold this button for about 2 seconds until the status LED blinks slowly, and release (See "Printing a demo page" on page 28).
Printing configuration sheets	In ready mode, press and hold this button for about 5 seconds until the status LED blinks quickly, and release (See "Printing a machine report" on page 72).
Canceling print job	Press Cancel (⊘) button during printing. The red LED blinks while the print job is cleared from both the machine and the computer and then the machine returns to ready mode. This may take some time depending on the size of the print job.

WPS button

(CLP-325W(K)/CLP-326W only)

This feature automatically detects which WPS (Wi-Fi Protected Setup™) mode your access point uses. By pushing a button on the wireless LAN router / access point and the machine, you can setup the wireless network and security settings (See "Setting a wireless network with the WPS button" on page 41).

Power button



This button must be used to turn the machine on/off.

Turning on the machine

- 1.Plug in the power cord.
- 2.Press **Power** (⏻) button on the control panel.

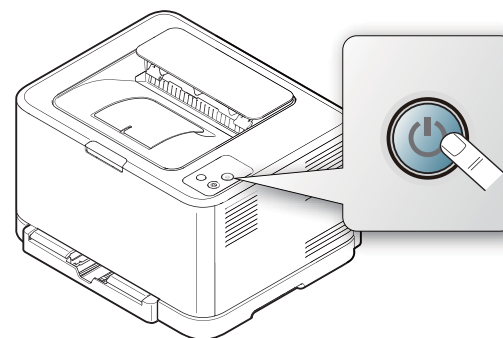

-  If you want to turn the power off, press and hold this button for about 3 seconds.

getting started

This chapter gives you step-by-step instructions for setting up the USB connected machine and software.

This chapter includes:

- Setting up the hardware
- Printing a demo page
- Supplied software

Setting up the hardware

This section shows the steps to set up the hardware as is explained in the Quick Installation Guide. Make sure you read the Quick Installation Guide first and follow the steps below.

Location

1. Select a stable location.

Select a level, stable place with adequate space for air circulation. Allow extra space to open cover(s) and tray(s).

The area should be well ventilated and away from direct sunlight or sources of heat, cold and humidity. Do not set the machine close to the edge of your desk or table.

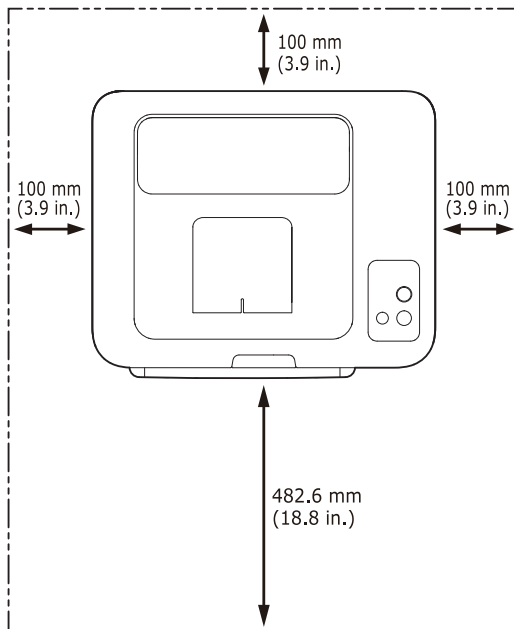

Printing is suitable for altitudes under 1,000 m (3,281 ft). Refer to the altitude setting to optimize your printing (See "Altitude adjustment" on page 50).

Place the machine on a flat, stable surface so that there is no incline greater than 2 mm (0.08 inch). Otherwise, printing quality may be

- System requirements
- Installing USB connected machine's driver
- Sharing your machine locally

affected.

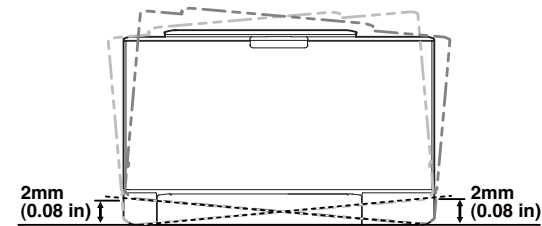

2. Unpack the machine and check all the enclosed items.
3. Remove tape holding the machine securely.
4. Load paper (See "Loading paper in the tray" on page 54).
5. Make sure that all cables are connected to the machine.
6. Turn the machine on (See "Turning on the machine" on page 27).



This machine will not operate when the power main fails.

Printing a demo page

Print a demo page to make sure that the machine is operating correctly.

To print a demo page

In ready mode, press and hold the **Cancel** (⊘) button for 2 seconds, then release. (CLP-325W(K)/CLP-326W only)



Also, you can use the **Demo page** (🖨️) button for printing a demo page. This button is supported on CLP-320N(K)/CLP-321N only.

Supplied software

After you have set up your machine and connected it to your computer, you must install the printer software. If you are a Windows or Macintosh OS user, install the software from the supplied CD. If you are a Linux OS user, download the software from the Samsung website (www.samsung.com/printer) and install.



Machine software is occasionally updated for reasons like the release of new operating system and etc. If needed, download the latest version from the Samsung website. (www.samsung.com/printer)

OS	Contents
Windows	<ul style="list-style-type: none"> • Printer driver: Use this driver to take full advantage of your machine's features. • Smart Panel: This program allows you to monitor the machine's status and alerts you when an error occurs during printing. • Printer Settings Utility: This program allows you to set up printer's other options from your computer. • SetIP: Use this program to set your machine's TCP/IP addresses. (CLP-320N(K)/CLP-321N/CLP-325W(K)/CLP-326W only)
Macintosh	<ul style="list-style-type: none"> • Printer Driver: Use this driver to take full advantage of your machine's features. • Smart Panel: This program allows you to monitor the machine's status and alerts you when an error occurs during printing. • Printer Settings Utility: This program allows you to set up printer's other options from your computer. • SetIP: Use this program to set your machine's TCP/IP addresses. (CLP-320N(K)/CLP-321N/CLP-325W(K)/CLP-326W only)
Linux	<ul style="list-style-type: none"> • Unified Linux Driver: Use this driver to take full advantage of your machine's features. • Smart Panel: This program allows you to monitor the machine's status and alerts you when an error occurs during printing. • Printer Settings Utility: This program allows you to set up printer's other options from your computer. • SetIP: Use this program to set your machine's TCP/IP addresses. (CLP-320N(K)/CLP-321N/CLP-325W(K)/CLP-326W only)

System requirements

Before you begin, ensure that your system meets the following requirements:

Microsoft® Windows®

Your machine supports the following Windows operating systems.

OPERATING SYSTEM	Requirement (recommended)		
	CPU	RAM	free HDD space
Windows® 2000	Intel® Pentium® II 400 MHz (Pentium III 933 MHz)	64 MB (128 MB)	600 MB
Windows® XP	Intel® Pentium® III 933 MHz (Pentium IV 1 GHz)	128 MB (256 MB)	1.5 GB
Windows Server® 2003	Intel® Pentium® III 933 MHz (Pentium IV 1 GHz)	128 MB (512 MB)	1.25 GB to 2 GB

OPERATING SYSTEM	Requirement (recommended)		
	CPU	RAM	free HDD space
Windows Server® 2008	Intel® Pentium® IV 1 GHz (Pentium IV 2 GHz)	512 MB (2048 MB)	10 GB
Windows Vista®	Intel® Pentium® IV 3 GHz	512 MB (1024 MB)	15 GB
Windows® 7	Intel® Pentium® IV 1 GHz 32-bit or 64-bit processor or higher	1 GB (2 GB)	16 GB
			<ul style="list-style-type: none"> • Support for DirectX® 9 graphics with 128 MB memory (to enable the Aero theme). • DVD-R/W Drive
Windows Server® 2008 R2	Intel® Pentium® IV 1 GHz (x86) or 1.4 GHz (x64) processors (2 GHz or faster)	512 MB (2048 MB)	10 GB

-  Internet Explorer® 5.0 or higher is the minimum requirement for all Windows operating systems.
- Administrator rights are required to install the software.
- **Windows Terminal Services** is compatible with this machine.

Macintosh

OPERATING SYSTEM	Requirements (recommended)		
	CPU	RAM	free HDD space
Mac OS X 10.3 ~ 10.4	<ul style="list-style-type: none"> • Intel® Processors • PowerPC G4/ G5 	<ul style="list-style-type: none"> • 128 MB for a PowerPC based Mac (512 MB) • 512 MB for a Intel-based Mac (1 GB) 	1 GB
Mac OS X 10.5	<ul style="list-style-type: none"> • Intel® Processors • 867 MHz or faster Power PC G4/ G5 	512 MB (1 GB)	1 GB
Mac OS X 10.6	<ul style="list-style-type: none"> • Intel® Processors 	1 GB (2 GB)	1 GB

Linux

Item	Requirement (recommended)
Operating system	RedHat® Enterprise Linux WS 4, 5 (32/64 bit) Fedora Core 2~10 (32/64 bit) SuSE Linux 9.1 (32 bit) OpenSuSE® 9.2, 9.3, 10.0, 10.1, 10.2, 10.3, 11.0, 11.1 (32/64 bit) Mandrake 10.0, 10.1 (32/64 bit) Mandriva 2005, 2006, 2007, 2008, 2009 (32/64 bit) Ubuntu 6.06, 6.10, 7.04, 7.10, 8.04, 8.10 (32/64 bit) SuSE Linux Enterprise Desktop 9, 10 (32/64 bit) Debian 3.1, 4.0, 5.0 (32/64 bit)
CPU	Pentium® IV 2.4 GHz (Intel Core™2)
RAM	512 MB (1024 MB)
Free HDD space	1 GB (2 GB)

Installing USB connected machine's driver

A locally connected machine is a machine directly connected to your computer by a USB cable. If your machine is attached to a network, skip the following steps below and go on to installing network connected machine's driver (See "Installing network connected machine's driver" on page 37).

 Only use a USB cable no longer than 3 m (10 ft.).

Windows

You can install the machine software using the typical or custom method. The following steps below are recommended for most users who use a machine directly connected to your computer. All components necessary for machine operations will be installed.

1. Make sure that the machine is connected to the computer and powered on.

 If the "**Found New Hardware Wizard**" window appears during the installation procedure, click **Cancel** in close the window.

2. Insert the supplied software CD into your CD-ROM drive.

•The software CD should automatically run and an installation window will appear.

•If the installation window does not appear, click **Start** and then **Run**. Type **X:\Setup.exe**, replacing "X" with the letter which represents your CD-ROM drive. Click **OK**.

•If you use Windows Vista, Windows 7 or Windows Server 2008 R2 click **Start > All programs > Accessories > Run**.

Type **X:\Setup.exe** replacing "X" with the letter which represents your CD-ROM drive and click **OK**.

•If the **AutoPlay** window appears in Windows Vista, Windows 7 or Windows Server 2008 R2, click **Run Setup.exe** in **Install or run program** field, and click **Continue** or **Yes** in the **User Account Control** window.

3. Select **Install now**.

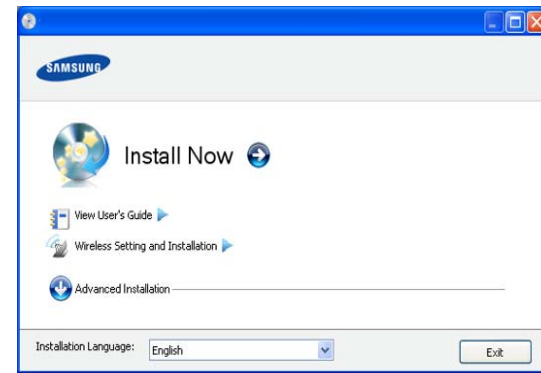

If necessary, select a language from the drop-down list.

-  For CLP-325W(K)/CLP-326W, you can access **Wireless Setting and Installation** menu. The **Wireless Setting and Installation** allows you to install a wireless network to connect to the machine with USB cable (See "Setting a wireless network with USB cable" on page 41).
- The **Advanced Installation** has two options, **Custom Installation** and **Install Software Only**. The **Custom Installation** allows you to select the machine's connection and choose individual component to install. The **Install Software Only** allows you to install the supplied software such as Smart Panel. Follow the guide in the window.

4. Read **License Agreement**, and select **I accept the terms of the License Agreement**. Then, click **Next**.

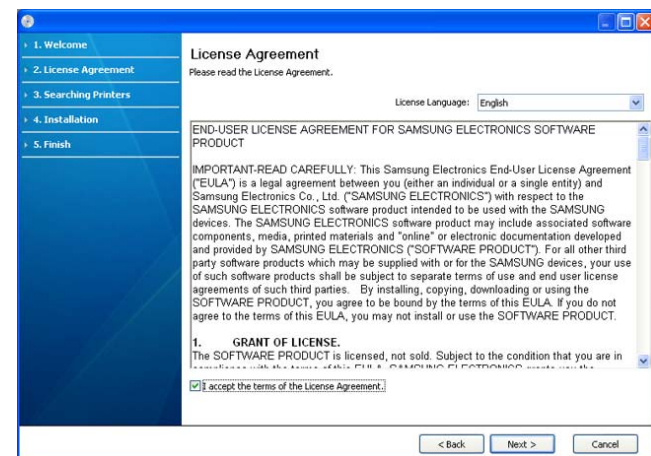

The program searches for the machine.

 If your machine is not found in the network or locally, the following

window will appear.

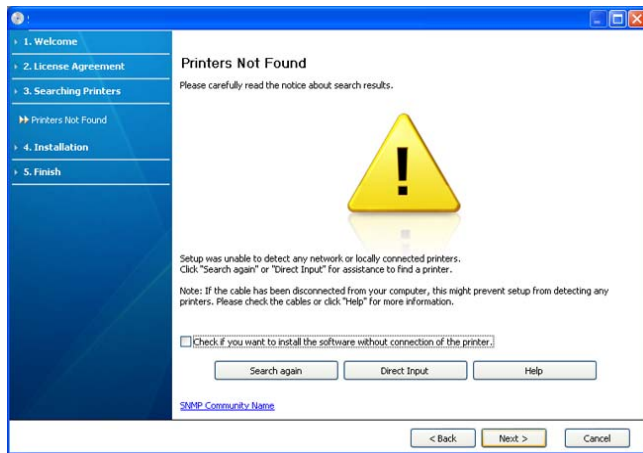

•**Check if you want to install the software without connection of the printer.**

-Check this option to install this program without a machine connected. In this case, the print a test page window will be skipped, and completes the installation.

•**Search again**

When you press this button, the firewall notice window appears.

-Turn off the firewall and **Search again**. For Window operating system, click **Start > Control Panel > Windows Firewall**, and inactivate this option. For other operating system, refer to its on-line guide.

-Turn off the firewall from the third party's program beside the operating system. Refer to the manual provided by individual programs.

•**Direct Input**

The **Direct Input** allows you to search a specific machine on the network.

-**Search by IP address:** Enter the IP address or the host name. Then click **Next**.

To verify your machine's IP address, print a network configuration report (See "Printing a machine report" on page 72).

-**Search by network path:** To find a shared machine (UNC Path), enter the shared name manually or find a shared printer by clicking the **Browse** button. Then click **Next**.

•**Help**

If your machine is not connected to the computer or network, This help button gives you the detailed information about how to connect the machine.

5. The searched machines will be shown on the screen. Select the one you wish to use and click **Next**.

 If the driver searched only one machine, the confirmation window appears.

6. After the installation is finished, a window asking you to print a test page appears. If you want to print a test page, click **Print a test page**. Otherwise, just click **Next** and skip to step 8.
7. If the test page prints out correctly, click **Yes**. If not, click **No** to reprint it.
8. If you want to register your machine on Samsung website, click **On-line Registration**.

 If your machine is not connected yet to the computer, click **How to connect?**. **How to connect?** gives detailed information about how to connect the machine. Follow the instructions in the window.

9. Click **Finish**.

-  If the printer driver does not work properly, follow the steps below to repair or reinstall the driver.
- a) Make sure that the machine is connected to your machine and powered on.
 - b) From the **Start** menu, select **Programs** or **All Programs > Samsung Printers > your printer driver name > Maintenance**.
 - c) Select the option you wish to execute, then follow the instruction on the window.

Macintosh

The software CD that came with your machine provides you with the Driver files that allow you to use the CUPS driver or PostScript driver (only available when you use a machine, which supports the PostScript driver) for printing on a Macintosh computer.

1. Make sure that the machine is connected to your computer and powered on.
2. Insert the supplied software CD into your CD-ROM drive.
3. Double-click the CD-ROM icon that appears on your Macintosh desktop.
4. Double-click the **MAC_Installer** folder.
5. Double-click the **Installer OS X** icon.
6. Enter the password and click **OK**.
7. The Samsung Installer window opens. Click **Continue**.
8. Read the license agreement and click **Continue**.
9. Click **Agree** to agree to the license agreement.
10. Select **Easy Install** and click **Install**. **Easy Install** is recommended for most users. All components necessary for machine operations will be installed.
If you select **Custom Install**, you can choose individual components to install.
11. When the message which warns that all applications will close on your computer appears, click **Continue**.
12. Select the installation type you want and click **OK**.
 - Typical installation for a local printer:** Installs default components for a device that is directly connected to user's computer.
 - Typical installation for a network printer:** Installs software for a device that is on the network. The SetIP program automatically runs. If the machine has already configured network information, close the SetIP program. Go to the next step.
 - Wireless Setting and Installation :** For CLP-325W(K)/CLP-326W, you can access **Wireless Setting and Installation** menu. The **Wireless Setting and Installation** allows you to install a wireless network to connect to the machine with USB cable (See "Setting a wireless network with USB cable" on page 41).
13. Follow the instructions on the screen to complete the installation. After the installation is finished, click **Quit** or **Restart**.
14. Open the **Applications** folder > **Utilities** > **Print Setup Utility**.
 - For Mac OS X 10.5 ~ 10.6, open the **Applications** folder > **System Preferences** and click **Print & Fax**.
15. Click **Add** on the **Printer List**.
 - For Mac OS X 10.5 ~ 10.6, click the "+" icon; a display window will pop-up.
16. For Mac OS X 10.3, select the **USB** tab.
 - For Mac OS X10.4, click **Default Browser** and find the USB

connection.

•For Mac OS X 10.5 ~ 10.6, click **Default** and find the USB connection.

17. For Mac OS X 10.3, if Auto Select does not work properly, select **Samsung** in **Printer Model** and your machine name in **Model Name**.

•For Mac OS X 10.4, if Auto Select does not work properly, select **Samsung** in **Print Using** and your machine name in **Model**.

•For Mac OS X 10.5 ~ 10.6, if Auto Select does not work properly, select **Select a driver to use...** and your machine name in **Print Using**.

Your machine appears on the **Printer List**, and is set as the default machine.

18. Click **Add**.

 If the printer driver does not work properly, uninstall the driver and reinstall it.

Follow steps below to uninstall the driver for Macintosh.

- a)Make sure that the machine is connected to your computer and powered on.
- b)Insert the supplied software CD into your CD-ROM drive.
- c)Double-click CD-ROM icon that appears on your Macintosh desktop.
- d)Double-click the **MAC_Installer** folder.
- e)Double-click the **Installer OS X** icon.
- f)Enter the password and click **OK**.
- g)The Samsung Installer window opens. Click **Continue**.
- h)Read the license agreement and click **Continue**.
- i)Click **Agree** to agree to the license agreement.
- j)Select **Uninstall** and click **Uninstall**.
- k)When the message which warns that all applications will close on your computer appears, Click **Continue**.
- l)When the uninstall is done, click **Quit**.

Linux

You need to download Linux software packages from the Samsung website to install the printer software.

Follow the steps below to install the software.

Installing the Unified Linux Driver

- 1.Make sure that the machine is connected to your computer and powered on.
- 2.When the **Administrator Login** window appears, type in root in the **Login** field and enter the system password.

 You must log in as a super user (root) to install the machine software. If you are not a super user, ask your system administrator.

- 3.From the Samsung website, download the Unified Linux Driver package to your computer.
- 4.Right-click the **Unified Linux Driver** package and extract the package.
- 5.Double click **cdroot > autorun**.

6.When the welcome screen appears, click **Next**.

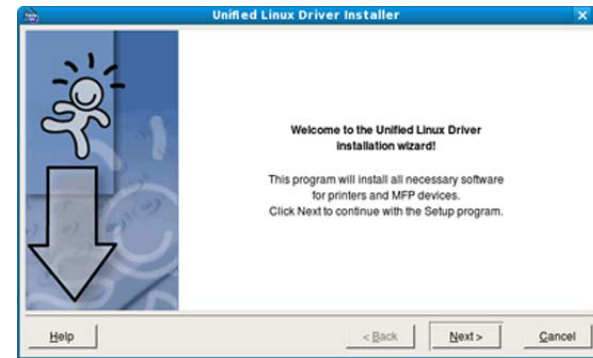

7.When the installation is complete, click **Finish**.

The installation program added the Unified Driver Configurator desktop icon and the Unified Driver group to the system menu for your convenience. If you have any difficulties, consult the on screen help that is available through your system menu or from the driver package Windows applications, such as **Unified Driver Configurator**.

Installing the Smart Panel

- 1.Make sure that the machine is connected to your computer and powered on.
- 2.When the **Administrator Login** window appears, type in root in the **Login** field and enter the system password.

 You must log in as a super user (root) to install the machine software. If you are not a super user, ask your system administrator.

- 3.From the Samsung website, download the **Smart Panel** package to your computer.
- 4.Right-click the Smart Panel package and extract the package.
- 5.Double click **cdroot > Linux > smartpanel > install.sh**.

Installing the Printer Settings Utility

- 1.Make sure that the machine is connected to your computer and powered on.
- 2.When the **Administrator Login** window appears, type in root in the **Login** field and enter the system password.

 You must log in as a super user (root) to install the machine software. If you are not a super user, ask your system administrator.

- 3.From the Samsung website, download the Printer Settings Utility package to your computer.
- 4.Right-click the **Printer Settings Utility** package and extract the package.
- 5.Double click **cdroot > Linux > psu > install.sh**.

 If the printer driver does not work properly, uninstall the driver and reinstall it.

Follow the steps below to uninstall the driver for Linux.

- a)Make sure that the machine is connected to your computer and powered on.
- b)When the **Administrator Login** window appears, type in "root" in the **Login** field and enter the system password.

You must log in as a super user (root) to uninstall the printer driver. If you are not a super user, ask your system administrator.

c)Click the icon at the bottom of the desktop. When the Terminal screen appears, type in:

```
[root@localhost root]#cd /opt/Samsung/mfp/uninstall/
```

```
[root@localhost uninstall]#./uninstall.sh
```

d)Click **Uninstall**.

e)Click **Next**.

f)Click **Finish**.

Sharing your machine locally

Follow the steps below to set up computers to share your machine locally. If the Host computer is directly connected to the machine with a USB cable and is also connected to the local network environment, the client computer connected to the local network can use the shared machine through the host computer to print.

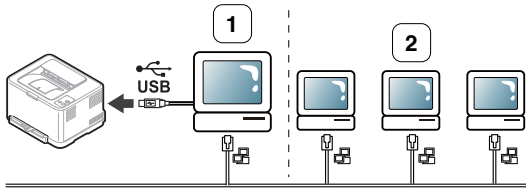

1	Host computer	A computer which is directly connected to the machine by USB cable.
2	Client computers	Computers which use the machine shared through the host computer.

Windows

Setting up a host computer

- 1.Install your printer driver (See "Installing USB connected machine's driver" on page 30, "Installing network connected machine's driver" on page 37).
- 2.Click the Windows **Start** menu.
- 3.For Windows 2000, select **Settings > Printers**.
 - For Windows XP/Server 2003, select **Printers and Faxes**.
 - For Windows Server 2008/Vista, select **Control Panel > Hardware and Sound > Printers**.
 - For Windows 7, select **Control Panel > Devices and Printers**.
 - For Windows Server 2008 R2, select **Control Panel > Hardware > Devices and Printers**.
- 4.Right-click the printer icon.
- 5.For Windows XP/Server 2003/Server 2008/Vista, press **Properties**.
For Windows 7 or Windows Server 2008 R2, from context menus, select the **Printer properties**.
 -  If **Printer properties** item has a ► mark, you can select other printer drivers connected with the selected printer.
- 6.Select the **Sharing** tab.
- 7.Check **Change Sharing Options**.
- 8.Check the **Share this printer** checkbox.
- 9.Fill in the **Share Name** field. Click **OK**.

Setting up a client computer

- 1.Install your printer driver (See "Installing USB connected machine's driver" on page 30, "Installing network connected machine's driver" on page 37).
- 2.Click the Windows **Start** menu.
- 3.Select **All programs > Accessories > Windows Explorer**.
- 4.Enter the IP address of the host computer in the address bar and press Enter in your keyboard.



 In case host computer requires a **User name** and **Password**, fill in User ID and password of the host computer account.

- 5.Right-click the printer icon you want to share and select **Connect**.
- 6.If a set up complete message appears, click **OK**.
- 7.Open the file you want to print and start printing.

Macintosh

 The following steps are for Mac OS X 10.5~10.6. Refer to Mac Help for other OS versions.

Setting up a host computer

- 1.Install your printer driver (See "Macintosh" on page 31).
- 2.Open the **Applications** folder > **System Preferences** and click **Print & Fax**.
- 3.Select the printer to share in the **Printers list**.
- 4.Select **Share this printer**.

Setting up a client computer

- 1.Install your printer driver (See "Macintosh" on page 31).
- 2.Open the **Applications** folder > **System Preferences** and click **Print & Fax**.
- 3.Click the "+" icon.
A display window showing the name of your shared printer appears.
- 4.Select your machine and click **Add**.

network setup (clp-320n(k)/clp-321 n/clp-325w(k)/clp-326w only)

This chapter gives you step-by-step instructions for setting up the network connected machine and software.

This chapter includes:

- Network environment
- Introducing useful network programs

Network environment

You need to set up the network protocols on the machine to use it as your network machine. You can set up the basic network settings through the machine's control panel or network setting programs.

The following table shows the network environments supported by the machine:

Item	Requirements
Network interface	<ul style="list-style-type: none">• Ethernet 10/100 Base-TX• 802.11 b/g/n wireless LAN (CLP-325W(K)/CLP-326W only)
Network operating system	<ul style="list-style-type: none">• Windows 2000/Server 2003 /Server 2008/XP/Vista/7/Server 2008 R2• Various Linux OS• Mac OS X 10.3 ~ 10.6
Network protocols	<ul style="list-style-type: none">• TCP/IPv4• DHCP, BOOTP• DNS, WINS, Bonjour, SLP, UPnP• Standard TCP/IP Printing (RAW), LPR, IPP• SNMPv 1/2/3, HTTP, IPsec• TCP/IPv6 (DHCP, DNS, RAW, LPR, SNMPv 1/2/3, HTTP, IPsec) <p>See "IPv6 configuration" on page 36.</p>
Wireless security	<ul style="list-style-type: none">• Authentication: Open System, Shared Key, WPA Personal, WPA2 Personal (PSK)• Encryption: WEP64, WEP128, TKIP, AES

Introducing useful network programs

There are several programs available to setup the network settings easily in network environment. For the network administrator especially, managing several machines on the network is possible.

 Before using the programs below, set the IP address first.

- Using a wired network
- Installing network connected machine's driver

SyncThru™ Web Service

Web server embedded on your network machine, which allows you to:

- Configure the network parameters necessary for the machine to connect to various network environments.
 - Customize machine settings.
- See "Using SyncThru™ Web Service" on page 68.

SyncThru™ Web Admin Service

A web-based machine management solution for network administrators. SyncThru™ Web Admin Service provides you with an efficient way of managing network devices and lets you remotely monitor and troubleshoot network machines from any site with corporate internet access. Download this program from <http://solution.samsungprinter.com>.

SetIP

This utility program allows you to select a network interface and manually configure the IP addresses for use with the TCP/IP protocol.

- See "IPv4 setting using SetIP Program (Windows)" on page 35.
- See "IPv4 setting using SetIP Program (Macintosh)" on page 35.
- See "IPv4 setting using SetIP Program (Linux)" on page 36.

 TCP/IPv6 is not supported by this program.

Using a wired network

You must set up the network protocols on your machine to use it on your network. This chapter will show you how this is easily accomplished.

You can use network after connecting network cable to a corresponding port on your machine.

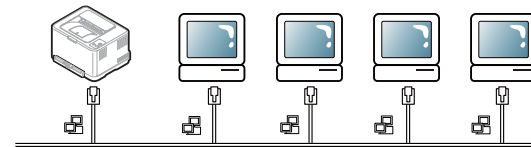

Printing network configuration report

You can print a **Network Configuration Report** from the machine's control panel that will show the current machine's network settings. This will help you to set up a network and troubleshoot problems.

To print the report:

In ready mode, press and hold the  (cancel button) for about 5 seconds.

You can find your machine's MAC address and IP address.

For example:

- MAC Address: 00:15:99:41:A2:78
- IP Address: 192.0.0.192

Setting IP address

Firstly, you have to set up an IP address for network printing and managements. In most cases a new IP address will be automatically assigned by a DHCP (Dynamic Host Configuration Protocol) server located on the network.

In a few situations the IP address must be set manually. This is called a static IP and is often required in corporate Intranets for security reasons.

- **DHCP IP assignment:** Connect your machine to the network, and wait a few minutes for the DHCP server to assign an IP address to the machine. Then, print the **Network Configuration Report** as explained above. If the report shows that the IP address has changed, the assignment was successful. You will see the new IP address in the report.
- **Static IP assignment:** Use SetIP program to change the IP address from your computer.

In an office environment, we recommend that you contact a network administrator to set this address for you.

IPv4 configuration

IPv4 setting using SetIP Program (Windows)

This program is for manually setting the network IP address of your machine using its MAC address to communicate with the machine. A MAC address is the hardware serial number of the network interface and can be found in the **Network Configuration Report**.

For using SetIP program, disable the computer firewall before continuing by performing the following:

1. Open **Start > Control Panel**.
2. Double click **Security Center**.
3. Click **Firewall**.
4. Disable the firewall.

Installing the program

1. Insert the Printer Software CD-ROM provided with your machine. When the driver CD runs automatically, close that window.
2. Start Windows Explorer and open the X drive. (X represents your CD-ROM drive.)
3. Double-click **Application > SetIP**.
4. Double-click **Setup.exe** to install this program.
5. Select a language, then click **Next**.
6. Follow the instructions in the window and complete the installation.

Starting the program

1. Connect your machine to the network with a network cable.
2. Turned on the machine.
3. From the Windows **Start** menu, select **All Programs > Samsung Printers > SetIP > SetIP**.

4. Click on the  icon (third from left) in the SetIP window to open the TCP/IP configuration window.
5. Enter the machine's new information into the configuration window as follows. In a corporate intranet, you may need to have this information assigned by a network manager before proceeding.

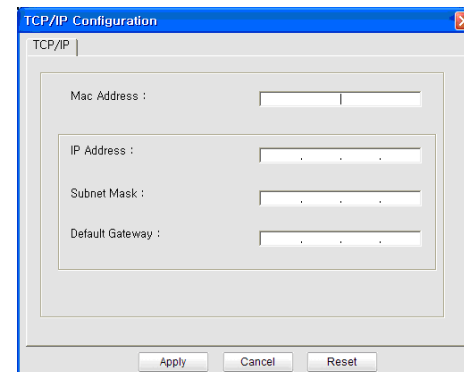

- **MAC Address:** Find the machine's MAC address from the **Network Configuration Report** and enter it without the colons. For example, 00:15:99:29:51:A8 becomes 0015992951A8.
- **IP Address:** Enter a new IP address for your printer. For example, if your computer's IP address is 192.168.1.150, enter 192.168.1.X. (X is number between 1 and 254 other than the computer's address.)
- **Subnet Mask:** Enter a Subnet Mask.
- **Default Gateway:** Enter a Default Gateway.

6. Click **Apply**, and then click **OK**. The machine will automatically print the **Network Configuration Report**. Confirm that all the settings are correct.
7. Click **Exit** to close the SetIP program.
8. If necessary, restart the computer's firewall.

IPv4 setting using SetIP Program (Macintosh)

For using SetIP program, disable the computer firewall before continuing by performing the following:

-  The path and UIs may differ by Mac OS version. Refer to the Mac OS manual.

1. Open **System Preferences**.
2. Click **Security**.
3. Click the **Firewall** menu.
4. Turn firewall off.

-  The following instructions may vary for your model.

1. Connect your machine to the network with a network cable.
2. Insert the Installation CD-ROM, and open the disk window, select **MAC_Installer > MAC_Printer > SetIP > SetIPApplet.html**.
3. Double click the file and **Safari** will automatically open, then select **Trust**. The browser will open the **SetIPApplet.html** page that shows the printer's name and IP address information.
4. Click on the  icon (third from left) in the SetIP window to open the TCP/IP configuration window.
5. Enter the machine's new information into the configuration window as follows. In a corporate intranet, you may need to have this information assigned by a network manager before proceeding.
 - **MAC Address:** Find the machine's MAC address from the **Network Configuration Report** and enter it without the colons. For

example, 00:15:99:29:51:A8 becomes 0015992951A8.

•**IP Address:** Enter a new IP address for your printer.

For example, if your computer's IP address is 192.168.1.150, enter 192.168.1.X. (X is number between 1 and 254 other than the computer's address.)

•**Subnet Mask:** Enter a Subnet Mask.

•**Default Gateway:** Enter a Default Gateway.

6. Select **Apply**, then **OK**, and **OK** again. The printer will automatically print the configuration report. Confirm that all the settings are correct. **Quit Safari.** You may close and eject the installation CD-ROM. If necessary, restart the computer's firewall. You have successfully changed the IP address, subnet mask, and gateway.

IPv4 setting using SetIP Program (Linux)

SetIP program should be automatically installed during the printer driver installation.

 The path and UIs may differ by Linux OS version. Refer to the Linux OS manual to turn firewall off.

1. Print the machine's network configuration report to find your machine's MAC address.
2. Open the `/opt/Samsung/mfp/share/utills/`.
3. Double click the `SetIPApplet.html` file.
4. Click to open the TCP/IP configuration window.
5. Enter the network card's MAC address, IP address, subnet mask, default gateway, and then click **Apply**.
 When you enter the MAC address, enter it without a colon(:).
6. The machine prints the network configuration report. Confirm all the settings are correct.
7. Close the SetIP program.

IPv6 configuration

 **TCP/IPV6** is supported properly only in Windows Vista or higher.

 If the IPv6 network seems to not be working, set all the network setting to the factory defaults and try again (See "Restoring factory default settings using SyncThru™ Web Service" on page 36).

To use the IPv6 network environment, follow the next procedure to use the IPv6 address.

The machine is provided with IPv6 feature on.

1. Connect your machine to the network with a network cable.
2. Turn on the machine.
3. Print a **Network Configuration Report** from the machine's control panel that will check IPv6 addresses.
4. Select **Start > Control Panel > Hardware and Sound > Printers > Add Printer**.
5. Click **Add a local printer** on the **Add Printer** windows.
6. Follow the instruction on the window.

 If the machine does not work in the network environment, activate IPv6. Refer to the next section followed by.

Printing network configuration report

You can print a **Network Configuration Report** from the machine's control panel that will show the current machine's network settings. This will help you to set up a network and troubleshooting problems.

To print the report:

In ready mode, press and hold the  (cancel button) for about 5 seconds. You can find your machine's MAC address and IP address. For example:

•MAC Address: 00:15:99:41:A2:78

•IP Address: 192.0.0.192

Setting IPv6 addresses

Machine supports following IPv6 addresses for network printing and managements.

- Link-local Address:** Self-configured local IPv6 address. (Address starts with FE80.)
- Stateless Address:** Automatically configured IPv6 address by a network router.
- Stateful Address:** IPv6 address configured by a DHCPv6 server.
- Manual Address:** Manually configured IPv6 address by a user.

Manual address configuration

1. Start a web browser such as Internet Explorer that supports IPv6 addressing as a URL (See "SyncThru™ Web Service" on page 34).

 For IPv4, enter the IPv4 address (`http://xxx.xxx.xxx.xxx`) in the address field and press the Enter key or click **Go**.

2. When the **SyncThru™ Web Service** window opens, click **Network Settings**.
3. Click **TCP/IPv6**.
4. Enable the **Manual Address** In the **TCP/IPv6** section.
5. Select the **Address/Prefix** and click the **Add** button, then the router prefix will automatically be entered into the address field. Enter the rest of address. (ex: `3FFE:10:88:194::AAAA`. "A" is the hexadecimal 0 through 9, A through F.)
6. Click the **Apply** button.

Installing printer driver

Driver installation for network printer in IPv6 network environment is same as TCP/IPv4 (See "Installing network connected machine's driver" on page 37).

Select TCP/IP Port and when the list of machines are displayed, simply select your machine's IPv6 address.

Using SyncThru™ Web Service

1. Start a web browser such as Internet Explorer that supports IPv6 addressing as a URL.
2. Select one of the IPv6 addresses (**Link-local Address, Stateless Address, Stateful Address, Manual Address**) from **Network Configuration Report**.
3. Enter the IPv6 addresses. (ex: `http://[FE80::215:99FF:FE66:7701]`)

 Address must be enclosed in '['' brackets.

Restoring factory default settings using SyncThru™ Web Service

1. Start a web browser such as Internet Explorer, Safari or Firefox and enter your machine's new IP address in the browser window.

For example,

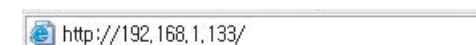
 `http://192.168.1.133/`

2. Click **Go** to access the SyncThru™ Web Service.
3. Click **Login** on the upper right of the SyncThru™ Web Service website.

A log-in page appears.

4. Type in the **ID** and **Password** then click **Login**.

If it's your first time logging into SyncThru™ Web Service, type in the below default ID and password.

- ID: admin**
- Password: sec00000**

5. When the **SyncThru™ Web Service** window opens, click **Settings > Network Settings > Restore Default**.
6. Click **Clear** for network.
7. Turn off and restart machine to apply settings.

Installing network connected machine's driver

You must install the printer driver software for printing. The software includes drivers, applications, and other user friendly programs.

Make sure that the network setup for your machine is completed. All applications should be closed on your computer before beginning installation.

Windows

This is recommended for most users. All components necessary for machine operations will be installed.

Follow the steps below:

1. Make sure that the machine is connected to the network and powered on.
2. Insert the supplied software CD into your CD-ROM drive.
 - The software CD should automatically run and an installation window appear.
 - If the installation window does not appear, click **Start** and then **Run**. Type **X:\Setup.exe**, replacing "X" with the letter which represents your CD-ROM drive. Click **OK**.
 - If you use Windows Vista, Windows 7 and Windows Server 2008 R2, click **Start > All programs > Accessories > Run**. Type **X:\Setup.exe** replacing "X" with the letter which represents your CD-ROM drive and click **OK**.
 - If the **AutoPlay** window appears in Windows Vista, Windows 7 and Windows Server 2008 R2, click **Run Setup.exe** in **Install or run program** field, and click **Continue** or **Yes** in the **User Account Control** window.
3. Select **Install now**.

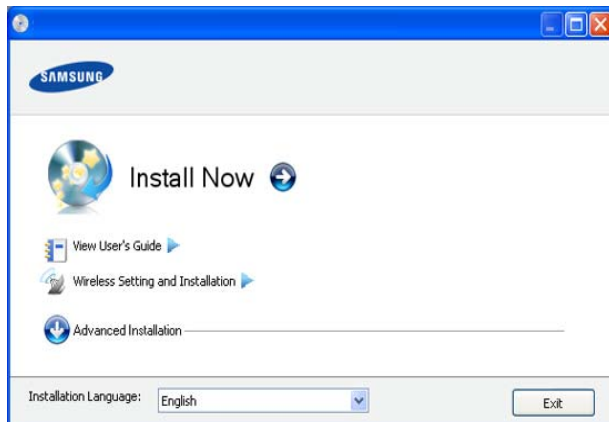

If necessary, select a language from the drop-down list.



- For CLP-325W(K)/, you can access **Wireless Setting and Installation** menu. The **Wireless Setting and Installation** allows you to install a wireless network to connect to the machine with USB cable (See "Setting a wireless network with USB cable" on page 41).
 - The **Advanced Installation** has two options, **Custom Installation** and **Install Software Only**. The **Custom Installation** allows you to select the machine's connection and choose individual component to install. The **Install Software Only** allows you to install the supplied software such as Smart Panel. Follow the guide in the window.
4. Read **License Agreement**, and select **I accept the terms of the License Agreement**. Then, click **Next**.

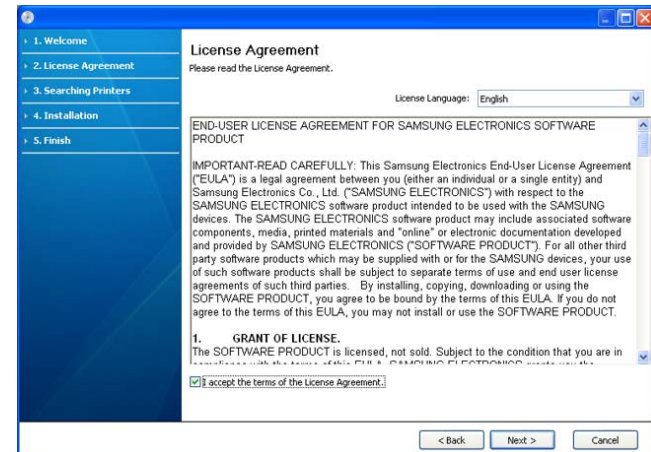

The program searches the machine.



- If your machine is not found in the network or locally, the following window will appear.

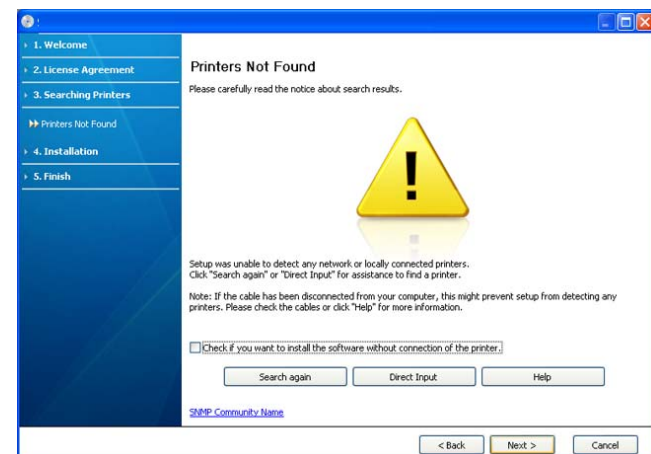

- Check if you want to install the software without connection of the printer.**
 - Check this option to install this program without a machine connected. In this case, the print a test page window will be skipped, and completes the installation.
- Search again**
 - When you press this button, the firewall notice window appears;

-Turn off the firewall and **Search again**. For Window operating system, click **Start > Control Panel > Windows Firewall**, and inactivate this option. For other operating system, refer to its on-line guide.

-Turn off the firewall from the third party's program beside the operating system. Refer to the manual provided by individual programs.

•Direct Input

The **Direct Input** allows you to search a specific machine on the network.

-**Search by IP address**: Enter the IP address or the host name. Then click **Next**.

To verify your machine's IP address, print a network configuration report (See "Printing a machine report" on page 72).

-**Search by network path**: To find a shared machine (UNC Path), enter the shared name manually or find a shared printer by clicking the **Browse** button. Then click **Next**.

•Help

If your machine is not connected to the computer or network, This help button gives you the detailed information about how to connect the machine.

5. The searched machines will be shown on the screen. Select the one you wish to use and click **Next**.

 If the driver searched only one machine, the confirmation window appears.

6. After the installation is finished, a window asking you to print a test page appears. If you want to print a test page, click **Print a test page**. Otherwise, just click **Next** and skip to step 8.

7. If the test page prints out correctly, click **Yes**.
If not, click **No** to reprint it.

8. If you want to register your machine on Samsung website, click **On-line Registration**.

 If your machine is not connected yet to the computer, click **How to connect?**. **How to connect?** gives detailed information about how to connect the machine. Follow the instructions in the window.

9. Click **Finish**.

 •After the driver setup, you may enable firewall.
•If the printer driver does not work properly, follow the steps below to repair or reinstall the driver.

- a) Make sure that the machine is connected to your machine and powered on.
- b) From the **Start** menu, select **Programs** or **All Programs > Samsung Printers > your printer driver name > Maintenance**.
- c) Select the option as you wish, follow the instruction on the window.

Macintosh

1. Make sure that the machine is connected to your network and powered on. Also, your machine's IP address should have been set.
2. Insert the supplied software CD into your CD-ROM drive.
3. Double-click the CD-ROM icon that appears on your Macintosh desktop.
4. Double-click the **MAC_Installer** folder.
5. Double-click the **Installer OS X** icon.
6. Enter the password and click **OK**.

7. The Samsung Installer window opens. Click **Continue**.

8. Read the license agreement and click **Continue**.

9. Click **Agree** to agree to the license agreement.

10. Select **Easy Install** and click **Install**. **Easy Install** is recommended for most users. All components necessary for machine operations will be installed.

•If you select **Custom Install**, you can choose individual components to install.

11. The message which warns that all applications will close on your computer appears. Click **Continue**.

12. Select the installation type you want and click **OK**.

•**Typical installation for a local printer**: Installs default components for a device that is directly connected to user's computer.

•**Typical installation for a network printer**: Installs software for a device that is on the network. The SetIP program automatically runs. If the machine has already configured network information, close the SetIP program. Go to the next step.

•**Wireless Setting and Installation** : For CLP-325W(K)/CLP-326W, you can access **Wireless Setting and Installation** menu. The **Wireless Setting and Installation** allows you to install a wireless network to connect to the machine with USB cable (See "Setting a wireless network with USB cable" on page 41).

13. Follow the instructions on the screen to complete the installation. After the installation is finished, click **Quit** or **Restart**.

14. Open the **Applications** folder > **Utilities** > **Print Setup Utility**.

•For Mac OS X 10.5~10.6, open the **Applications** folder > **System Preferences** and click **Print & Fax**.

15. Click **Add** on the **Printer List**.

•For Mac OS X 10.5~10.6, click the "+" icon; a display window will pop-up.

16. For Mac OS X 10.3, select the **IP Printing** tab.

•For Mac OS X 10.4, click **IP Printer**.

•For Mac OS X 10.5~10.6, click **IP**.

17. Select **Socket/HP Jet Direct** in **Printer Type**.

 When printing a document containing many pages, printing performance may be enhanced by choosing **Socket** for **Printer Type** option.

18. Enter the machine's IP address in the **Printer Address** field.

19. Enter the queue name in the **Queue Name** field. If you cannot determine the queue name for your machine server, try using the default queue first.

20. For Mac OS X 10.3, if Auto Select does not work properly, select **Samsung** in **Printer Model** and your machine name in **Model Name**.

•For Mac OS X 10.4, if Auto Select does not work properly, select **Samsung** in **Print Using** and your machine name in **Model**.

•For Mac OS X 10.5~10.6, if Auto Select does not work properly, select **Select a driver to use...** and your machine name in **Print Using**.

Your machine appears on the **Printer List**, and is set as the default machine.

21. Click **Add**.

 If the printer driver does not work properly, uninstall the driver and reinstall it.

Follow steps below to uninstall the driver for Macintosh.

a) Make sure that the machine is connected to your computer and powered on.

b) Insert the supplied software CD into your CD-ROM drive.

- c) Double-click CD-ROM icon that appears on your Macintosh desktop.
- d) Double-click the **MAC_Installer** folder.
- e) Double-click the **Installer OS X** icon.
- f) Enter the password and click **OK**.
- g) The Samsung Installer window opens. Click **Continue**.
- h) Read the license agreement and click **Continue**.
- i) Click **Agree** to agree to the license agreement.
- j) Select **Uninstall** and click **Uninstall**.
- k) When the message which warns that all applications will close on your computer appears, Click **Continue**.
- l) When the uninstall is done, click **Quit**.

Linux

You need to download Linux software packages from the Samsung website to install the printer software.



To install other software:

- See "Installing the Smart Panel" on page 32.
- See "Installing the Printer Settings Utility" on page 32.

Installing the Unified Linux Driver

1. Make sure that the machine is connected to your network and powered on. Also, your machine's IP address should have been set.
2. From the Samsung website, download the Unified Linux Driver package to your computer.
3. Right-click the **Unified Linux Driver** package and extract the package.
4. Double click **cdroot > autorun**.
5. The Samsung Installer window opens. Click **Continue**.
6. The Add printer wizard window opens. Click **Next**.
7. Select Network printer and click **Search** button.
8. The Printer's IP address and model name appears on list field.
9. Select your machine and click **Next**.
10. Input the printer description and **Next**
11. When the add printer is done, click **Finish**.
12. When the install is done, click **Finish**.

Add network Printer

1. Double-click the **Unified Driver Configurator**.
2. Click **Add Printer...**
3. The **Add printer wizard** window opens. Click **Next**.
4. Select **Network printer** and click the **Search** button.
5. The printer's IP address and model name appears on list field.
6. Select your machine and click **Next**.
7. Input the printer description and **Next**
8. When the add printer is done, click **Finish**.

wireless network setup (clp-325w(k)/clp-326w only)

This chapter gives you step-by-step instructions for setting up the wireless network connected machine and software.

This chapter includes:

- Getting started
- Choosing the wireless network installation type
- Setting a wireless network with the WPS button
- Setting a wireless network from the computer

 For more information about the network environment, network programs, and installing a network connected machine's driver, refer to the following chapters:



- See "Network environment" on page 34.
- See "Introducing useful network programs" on page 34.
- See "Installing network connected machine's driver" on page 37.

Getting started

Choosing your network connection

Typically, you can only have one connection between your computer and the machine at a time. There are two types of network connections to consider:

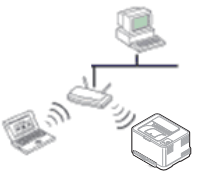
- Wireless network without access Point (Ad-Hoc mode)
- Wireless network with an access Point (Infrastructure mode)

	<p>Infrastructure mode</p> <p>This is an environment generally used for homes and SOHOs (Small Office/ Home Office). This mode uses an access point to communicate with the wireless machine.</p> <ul style="list-style-type: none">• See "Installing the machine on a wireless network with an access point (Windows)" on page 42.• See "Installing the machine on a wireless network with an access point (Macintosh)" on page 44.
	<p>Ad-Hoc mode</p> <p>This mode does not use an access point. The wireless computer and wireless machine communicates directly.</p> <ul style="list-style-type: none">• See "Installing the machine on an Ad-Hoc wireless network (Windows)" on page 43.• See "Installing the machine on an Ad-Hoc wireless network (Macintosh)" on page 45.

 After choosing your configuration, follow the simple directions for your computer's operating system, but first locate the software CD supplied with the machine before proceeding.

- Setting a wireless network from the computer
- Turning the Wi-Fi network on/off
- Troubleshooting



Wireless network name and network key

Wireless networks require higher security, so when an access point is first set up, a network name (SSID), the type of security used, and a Network Key are created for the network. Locate this information before proceeding with the machine installation.

Choosing the wireless network installation type

There are various ways to install the wireless network to connect to the machine. You can install a wireless network from the machine's control panel or the computer. **For most users, we recommend using the WPS () button to configure the wireless network settings.**

From the control panel

- **WPS ()**: If your machine and an access point (or wireless router) support Wi-Fi Protected Setup™ (WPS), you can easily configure the wireless network settings by pressing the **WPS ()** button on the control panel. (See "Setting a wireless network with the WPS button" on page 41).

From the computer

From the computer, we recommend using a USB cable with the program provided in the supplied software CD.

- **With a USB cable**: You can simply set up a wireless network using the program on the supplied software CD. Only Windows and Macintosh operating system are supported (See "Setting a wireless network with USB cable" on page 41).

 You can also install a wireless network in Printer Settings Utility with a USB cable after installing the driver (Windows and Macintosh operating systems are supported).

- **With a network cable**: You can set up a wireless network using the SyncThru™ Web Service program (See "Setting a wireless network with network cable" on page 46).

Setting a wireless network with the WPS button

You can install a wireless network with the **WPS ()** button.

 After completing the wireless network connection, you need to install a machine driver to print from an application (See "Installing network connected machine's driver" on page 37).

Setting a wireless network with the WPS button

If your machine and an access point (or wireless router) support Wi-Fi Protected Setup™ (WPS), you can easily configure the wireless network settings by pressing the **WPS** () button on the control panel.

 If you want to use the wireless network using the infrastructure mode, make sure that the network cable is disconnected from the machine. Using the WPS (PBC) button or entering the PIN number from the computer to connect to the Access Point varies depending on the access point (or wireless router) you are using. Refer to the user's guide of the access point (or wireless router) you are using.

Items to prepare

You need to ensure you have the following items ready to use:

- Check if the access point (or wireless router) supports Wi-Fi Protected Setup™ (WPS).
- Check if your machine supports Wi-Fi Protected Setup™ (WPS).
- Networked computer (PIN mode only)

Choosing your network connection

There are two methods to connect your machine to a wireless network using the **WPS** () button on the control panel.

The **Push Button Configuration (PBC)** method allows you to connect your machine to a wireless network by pressing both the **WPS** () button on the control panel of your machine and the WPS (PBC) button on a Wi-Fi Protected Setup™ (WPS)-enabled access point (or wireless router) respectively.



The **Personal Identification Number (PIN)** method helps you connect your machine to a wireless network by entering the supplied PIN information on a Wi-Fi Protected Setup™ (WPS)-enabled access point (or wireless router).

Factory default in your machine is **PBC** mode, which is recommended for a typical wireless network environment.



Connecting to a wireless network in PBC mode

To connect your machine to the wireless network in PBC mode, follow the following steps:

You need to check the status of the wireless LED.

1. Press and hold the **WPS** () button on the control panel for about 2 - 4 seconds until the status LED blinks quickly.
 -  : The light blinks slowly on wireless LED. The machine starts connecting to the wireless network. The LED blinks slowly for up to two minutes until you press the PBC button on access point (or wireless router).
2.  : Press the **WPS (PBC)** button on the access point (or wireless router).

The wireless LED blinks in the order below:

 - a)  : The light blinks fast on the wireless LED. The machine is connecting to the access point (or wireless router).
 - b)  : When the machine is successfully connected to the wireless network, the wireless LED light stays on.



Connecting to the wireless network in PIN mode

To connect your machine to the wireless network, follow the following steps:

You need to check the status of the wireless LED.



1. The network configuration report including PIN number must be printed.

In ready mode, press and hold the **Cancel** () button on the control panel for about 5 seconds. You can find your machine's PIN number.

2. Press and hold the **WPS** () button on the control panel for more than 4 seconds until the status LED on.
 -  : The light blinks slowly on the wireless LED. The machine starts connecting to access point (or wireless router).
3. You need to enter eight-digit PIN number within two minutes to the computer which is connected to the access point (or wireless router).

The LED blinks slowly for up to two minutes until you enter the eight-digit PIN number

The wireless LED blinks in the order below:

 - a)  : The light blinks fast on the wireless LED. The machine is connecting to the access point (or wireless router).
 - b)  : When the machine is successfully connected to the wireless network, the wireless LED light stays on.

Re-connecting to the wireless network

When the wireless function is off, the machine automatically tries to re-connect to the access point (or wireless router) with the previously used wireless connection settings and address.

-  In the following cases, the machine automatically re-connects to the wireless network:
- The machine is turned off and on again.
 - The access point (or wireless router) is turned off and on again.



Canceling a wireless network connection process

To cancel the wireless network connection function when the machine is connecting to the wireless network, press and release the **Cancel** () button on the control panel. **You need to wait 2 minutes to re-connect the wireless network.**

Disconnecting a wireless network connection

To disconnect the wireless network connection, press the **WPS** () button on the control panel for more than two seconds.

- **When the Wi-Fi Network is in idle mode:** The machine is immediately disconnected from the wireless network, and the wireless LED is off.
- **When the Wi-Fi Network is being used:** While the machine waits until the current job is finished, the light blinks fast on the wireless LED. Then, the wireless network connection is automatically disconnected. The wireless LED is off.

-  When the Wi-Fi Network is disconnected, press the **WPS** () button on the control panel. The Wi-Fi network is on and the setting a wireless network begins.

Setting a wireless network from the computer

You can install a wireless network a USB cable or a network cable from the computer.

Setting a wireless network with USB cable

-  See your network administrator, or the person that set up your wireless network, for information about your network configuration.

Installing the machine on a wireless network with an access point (Windows)

Items to prepare

Ensure you have the following items ready.

- Access point
- Network-connected computer
- Software CD that was provided with your machine
- The machine installed with a wireless network interface
- USB cable

Creating the infrastructure network in Windows

When the items are ready, follow the steps below:

1. Check whether the USB cable is connected to the machine.
2. Turn on your computer, access point, and machine.
3. Insert the supplied software CD into your CD-ROM drive.
 - The software CD should automatically run and an installation window appear.
 - If the installation window does not appear, click on **Start** and then **Run**. Type X:\Setup.exe, replacing "X" with the letter which represents your drive. Click on **OK**.
 - If you use Windows Vista, Windows 7, or Windows Server 2008 R2 click on **Start > All programs > Accessories > Run**. Type X:\Setup.exe replacing "X" with the letter that represents your drive and click on **OK**.
 - If the **AutoPlay** window appears in Windows Vista, Windows 7, or Windows Server 2008 R2, click on **Run Setup.exe** in **Install or run program** field, and click on **Continue** or **Yes** in the **User Account Control** window.
4. Select the **Wireless Setting and Installation** option.

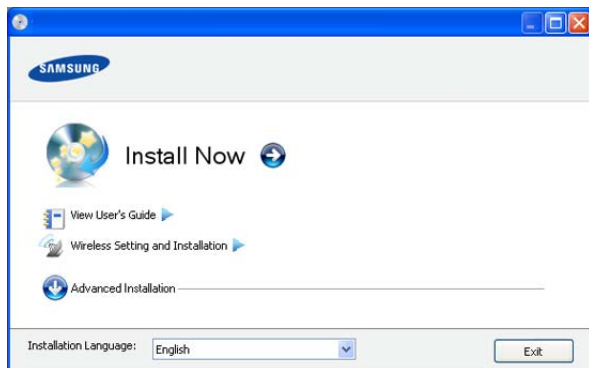

- **Install Now:** If you have already set up the wireless network, click on this button to install the machine driver to use the wireless network machine. If you have not set up the wireless network, click on the **Wireless Setting and Installation** button to set up the wireless network before you click on this button.
 - **Wireless Setting and Installation:** Configure the wireless network settings of your machine with a USB cable then install the machine driver. Only for the users who have not set up the wireless connection before.
5. Read the **License Agreement**, and select **I accept the terms of the License Agreement**. Then, click on **Next**.
 6. The software searches the wireless network.

 If the search has failed, you may check if the USB cable is properly connected between the computer and machine, and follow the instructions on the window.

7. After searching, the window shows the wireless network devices. Select the name (SSID) of the access point you are using and click on **Next**.

 If you cannot find out the network name you want to choose, or if you want to set the wireless configuration manually, click on **Advanced Setting**.

- **Enter the wireless Network Name:** Enter the SSID of access point you want (SSID is case-sensitive).
- **Operation Mode:** Select **Infrastructure**.
- **Authentication:** Select an authentication type.
 - **Open System:** Authentication is not used, and encryption may or may not be used, depending on the need for data security.
 - **Shared Key:** Authentication is used. A device that has a proper WEP key can access the network.
 - **WPA Personal or WPA2 Personal:** Select this option to authenticate the print server based on WPA Pre-Shared Key. This uses a shared secret key (generally called Pre-Shared Key pass phrase) which is manually configured on the access point and each of its clients.
- **Encryption:** Select the encryption (None, WEP64, WEP128, TKIP, AES, TKIP AES).
- **Network Key:** Enter the encryption network key value.
- **Confirm Network Key:** Confirm the encryption network key value.
- **WEP Key Index:** If you are using WEP Encryption, select the appropriate **WEP Key Index**.

 The wireless network security window appears when the access point has security setting.

The wireless network security window appears. The window may differ according to its security mode, WEP, or WPA.

•In case of WEP

Select **Open System** or **Shared Key** for the authentication and enter WEP security key. Click on **Next**.

WEP (Wired Equivalent Privacy) is a security protocol preventing unauthorized access to your wireless network. WEP encrypts the data portion of each packet exchanged on a wireless network using a 64-bit or 128-bit WEP encryption key.

•In case of WPA

Enter the WPA shared key and click on **Next**.

WPA authorizes and identifies users based on a secret key that changes automatically at regular intervals. WPA also uses TKIP (Temporal Key Integrity Protocol) and AES (Advanced Encryption Standard) for data encryption.

8. The window shows the wireless network settings and check if the settings are right. Click on **Next**.

•For the DHCP method

If the IP address assignment method is DHCP, check if DHCP is shown in the window. However, if it shows Static, click on **Change TCP/IP** to change the assignment method to DHCP.

•For the Static method

If the IP address assignment method is Static, check if Static is shown in the window. However, if it shows DHCP, click on **Change TCP/IP** to enter the IP address and other network configuration values for the machine. Before entering the IP address for the machine, you must know the computer's network configuration information. If the computer is set to DHCP, you

must contact the network administrator to get the static IP address.

For example:

If computer's network information is as shown below:

-IP address: 169.254.133.42

-Subnet Mask: 255.255.0.0

Then, the machine's network information should be as below:

-IP address: 169.254.133. 43

-Subnet Mask: 255.255.0.0 (Use the computer's subnet mask.)

-Gateway: 169.254.133.1

9. When the wireless network setting is completed, disconnect the USB cable between the computer and machine. Click on **Next**.

10. The **Wireless Network Setting Complete** window appears.

Select **Yes** if you accept the current settings and continue the setup procedure.

Select **No** if you want to return to the beginning screen.

Then, click on **Next**.

11. Click on **Next** when the **Confirm Printer Connection** window appears.

12. Select the components to be installed. Click on **Next**.

After selecting the components, you can also change the machine name, set the machine to be shared on the network, set the machine as the default machine, and change the port name of each machine. Click on **Next**.

13. After the installation is finished, a window asking you to print a test page appears. If you want to print a test page, click on **Print a test page**.

Otherwise, just click on **Next** and go to step 15.

14. If the test page prints out correctly, click on **Yes**.

If not, click on **No** to reprint it.

15. To register as a user of the machine in order to receive information from Samsung, click on **On-line Registration**.

16. Click on **Finish**.

Installing the machine on an Ad-Hoc wireless network (Windows)

If you do not have an access point (AP), you may still connect the machine wirelessly to your computer by setting up an Ad-Hoc wireless network by following the simple steps below.

Items to prepare

Ensure you have the following items ready:

- Network-connected computer
- Software CD that was provided with your machine
- The machine installed with a wireless network interface
- USB cable

Creating the Ad-Hoc network in Windows

When the items are ready, follow the steps below:

1. Check whether the USB cable is connected to the machine.
2. Turn on your computer and the wireless network machine.
3. Insert the supplied software CD into your CD-ROM drive.
 - The software CD should automatically run and an installation window appear.
 - If the installation window does not appear, click on **Start** and then **Run**. Type **X:\Setup.exe**, replacing "X" with the letter which represents your drive. Click on **OK**.

• If you use Windows Vista, Windows 7, or Windows Server 2008 R2 click on **Start > All programs > Accessories > Run**.

Type **X:\Setup.exe** replacing "X" with the letter that represents your drive and click on **OK**.

• If the **AutoPlay** window appears in Windows Vista, Windows 7, or Windows Server 2008 R2, click on **Run Setup.exe** in **Install or run program** field, and click on **Continue** or **Yes** in the **User Account Control** window.

4. Select the **Wireless Setting and Installation** option.

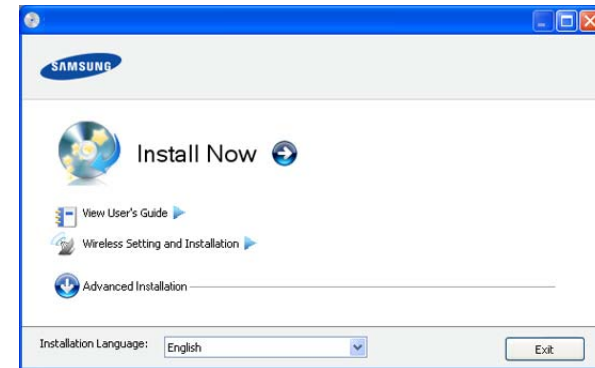

• **Install Now:** If you have set the wireless network, click on this button to install the machine driver to use the wireless network machine. If you have not set the wireless network, click on **Wireless Setting and Installation** button to set the wireless network before you click on this button.

• **Wireless Setting and Installation:** Configure the wireless network settings of your machine with a USB cable then install the machine driver. Only for users who have not set up the wireless connection before.

5. Read the **License Agreement**, and select **I accept the terms of the License Agreement**. Then, click on **Next**.

6. The software searches the wireless network.

 If the software has failed to search the network, check if the USB cable is connected properly between the computer and machine, and follow the instruction on the window.

7. After searching the wireless networks, a list of wireless networks your machine has searched appears.

If you want to use the Samsung default ad-hoc setting, select the last wireless network on the list, **Network Name (SSID)** is **portthru** and **Signal** is **Printer Self Network**.

Then, click on **Next**.

If you want to use other ad-hoc settings, select another wireless network from the list.

 If you want to change ad-hoc settings click on the **Advanced Setting** button.

• **Enter the wireless Network Name:** Enter the SSID name you want (SSID is case-sensitive).

• **Operation Mode:** Select **Ad-hoc**.

• **Channel:** Select the channel. (**Auto Setting** or 2412 MHz to 2467 MHz).

• **Authentication:** Select an authentication type.

Open System: Authentication is not used, and encryption may or may not be used, depending on the need for data security.

Shared Key: Authentication is used. A device that has a

proper WEP key can access the network.

- Encryption:** Select the encryption (None, WEP64, WEP128).
- Network Key:** Enter the encryption network key value.
- Confirm Network Key:** Confirm the encryption network key value.
- WEP Key Index:** If you are using the WEP Encryption, select the appropriate **WEP Key Index**.



The wireless network security window appears when the ad-hoc network has security setting.

The wireless network security window appears. Select **Open System** or **Shared Key** for the authentication and click on **Next**.

- WEP (Wired Equivalent Privacy) is a security protocol preventing unauthorized access to your wireless network. WEP encrypts the data portion of each packet exchanged on a wireless network using a 64-bit or 128-bit WEP encryption key.

8.The window showing the wireless network setting appears. Check the settings and click on **Next**.



Before entering the IP address for the machine, you must know the computer's network configuration information. If the computer's network configuration is set to DHCP, the wireless network setting should also be DHCP. Likewise, if the computer's network configuration is set to Static, the wireless network setting should also be Static.

If your computer is set to DHCP and you want to use the Static wireless network setting, you must contact the network administrator to get the static IP address.

•For the DHCP method

If the IP address assignment method is DHCP, check if DHCP is shown in the **Wireless Network Setting Confirm** window. However, if it shows Static, click on **Change TCP/IP** to change the assignment method to **Receive IP address automatically (DHCP)**.

•For the Static method

If the IP address assignment method is Static, check if Static is shown in the **Wireless Network Setting Confirm** window. However, if it shows DHCP, click on **Change TCP/IP** to enter the IP address and other network configuration values for the machine.

For example:

If computer's network information is as shown below:

-IP address: 169.254.133.42

-Subnet Mask: 255.255.0.0

Then, the machine's network information should be as below:

-IP address: 169.254.133. 43

-Subnet Mask: 255.255.0.0 (Use the computer's subnet mask.)

-Gateway: 169.254.133.1

9.When the wireless network setting is completed, disconnect the USB cable between the computer and machine. Click on **Next**.



If the **Change PC Network Setting** window appears, follow the steps on the window.

Click on **Next** if you are finished the computer's wireless network settings.

If you set the computer's wireless network on DHCP, it will take

several minutes to receive the IP address.

10.The **Wireless Network Setting Complete** window appears.

Select **Yes** if you accept the current settings and continue the setup procedure.

Select **No** if you want to return to the beginning screen.

Then, click on **Next**.

11.Click on **Next** when the **Confirm Printer Connection** window appears.

12.Select the components to be installed. Click on **Next**.

After selecting the components, you can also change the machine name, set the machine to be shared on the network, set the machine as the default machine, and change the port name of each machine. Click on **Next**.

13.After the installation is finished, a window asking you to print a test page appears. If you want to print a test page, click on **Print a test page**.

Otherwise, just click on **Next** and go to step 15.

14.If the test page prints out correctly, click on **Yes**.

If not, click on **No** to reprint it.

15.To register as a user of the machine in order to receive information from Samsung, click on **On-line Registration**.

16.Click on **Finish**.

Installing the machine on a wireless network with an access point (Macintosh)

Items to prepare

Ensure you have the following items ready:

- Access point
- Network-connected computer
- Software CD that was provided with your machine
- The machine installed with a wireless network interface
- USB cable

Creating the infrastructure network in Macintosh

When the items are ready, follow the steps below:

1. Check whether the USB cable is connected to the machine.
- 2.Turn on your computer, access point, and machine.
- 3.Insert the supplied software CD into your CD-ROM drive.
- 4.Double-click the CD-ROM icon that appears on your Macintosh desktop.

5.Double-click the **MAC_Installer** folder.

6.Double-click the **Installer OS X** icon.

7.Enter the password and click on **OK**.

8.The Samsung Installer window opens. Click on **Continue**.

9.Read the license agreement and click on **Continue**.

10.Click on **Agree** to agree to the license agreement.

11.The Samsung Installer window opens. Click on **Continue**.

12.Select **Easy Install** and click on **Install**. **Easy Install** is recommended for most users. All components necessary for machine operations will be installed.

If you select **Custom Install**, you can choose individual operations will be installed.

13.Select the **Wireless Setting and Installation** option.

14.The software searches the wireless network.



If the search has failed, you may check if the USB cable is connected between the computer and machine properly, and

follow the instructions in the window.

15. After searching, the window shows the wireless network devices. Select the name (SSID) of the access point you are using and click on **Next**.



When you set the wireless configuration manually, click on **Advanced Setting**.

- **Enter the wireless Network Name:** Enter the SSID of access point you want (SSID is case-sensitive).
- **Operation Mode:** Select **Infrastructure**.
- **Authentication:** Select an authentication type.
 - Open System:** Authentication is not used, and encryption may or may not be used, depending on the need for data security.
 - Shared Key:** Authentication is used. A device that has a proper WEP key can access the network.
 - WPA Personal or WPA2 Personal:** Select this option to authenticate the print server based on WPA Pre-Shared Key. This uses a shared secret key (generally called Pre-Shared Key pass phrase) that is manually configured on the access point and each of its clients.
- **Encryption:** Select the encryption. (None, WEP64, WEP128, TKIP, AES, TKIP AES)
- **Network Key:** Enter the encryption network key value.
- **Confirm Network Key:** Confirm the encryption network key value.
- **WEP Key Index:** If you are using the WEP Encryption, select the appropriate **WEP Key Index**.



The wireless network security window appears when the access point has security setting.

The wireless network security window appears. The window may differ according to its security mode: WEP or WPA.

•In case of WEP

Select **Open System** or **Shared Key** for the authentication and enter WEP security key. Click on **Next**.

WEP (Wired Equivalent Privacy) is a security protocol preventing unauthorized access to your wireless network. WEP encrypts the data portion of each packet exchanged on a wireless network using a 64-bit or 128-bit WEP encryption key.

•In case of WPA

Enter the WPA shared key and click on **Next**.

WPA authorizes and identifies users based on a secret key that changes automatically at regular intervals. WPA also uses TKIP (Temporal Key Integrity Protocol) and AES (Advanced Encryption Standard) for data encryption.

16. The window shows the wireless network setting and check if settings are right. Click on **Next**.

•For the DHCP method

If the IP address assignment method is DHCP, check if DHCP is shown in the window. However, if it shows Static, click on **Change TCP/IP** to change the assignment method to DHCP.

•For the Static method

If the IP address assignment method is Static, check if Static is shown in the window. However, if it shows DHCP, click **Change TCP/IP** to enter the IP address and other network configuration values for the machine. Before entering the IP address for the machine, you must know the computer's network configuration information. If the computer is set to DHCP, you must contact the

network administrator to get the static IP address.

For example:

If computer's network information is as shown below:

-IP address: 169.254.133.42

-Subnet Mask: 255.255.0.0

Then, the machine's network information should be as below:

-IP address: 169.254.133. 43

-Subnet Mask: 255.255.0.0 (Use the computer's subnet mask.)

-Gateway: 169.254.133.1

17. The wireless network connects according to the network configuration.
18. When the wireless network setting is completed, disconnect the USB cable between the computer and machine.
19. Follow the instructions on the screen to complete the installation. After the installation is finished, click on **Quit** or **Restart**.

Installing the machine on an Ad-Hoc wireless network (Macintosh)

If you do not have a access point (AP), you may still connect the machine wirelessly to your computer by setting up an Ad-Hoc wireless network by following these simple directions.

Items to prepare

Ensure you have following items ready:

- Network-connected computer
- Software CD that provided with your machine
- The machine installed with a wireless network interface
- USB cable

Creating the Ad-Hoc network in Macintosh

When the items are ready, follow these steps:

1. Check whether the USB cable is connected to the machine.
2. Turn on your computer and machine.
3. Insert the supplied software CD into your CD-ROM drive.
4. Double-click the CD-ROM icon that appears on your Macintosh desktop.
5. Double-click the **MAC_Installer** folder.
6. Double-click the **Installer OS X** icon.
7. Enter the password and click on **OK**.
8. The Samsung Installer window opens. Click on **Continue**.
9. Read the license agreement and click on **Continue**.
10. Click on **Agree** to agree to the license agreement.
11. Select **Easy Install** and click on **Install**. **Easy Install** is recommended for most users. All components necessary for machine operations will be installed.
If you select **Custom Install**, you can choose individual operations will be installed.
12. Click on **Wireless Setting and Installation**.
13. The software searches the wireless network devices.



If the search has failed, you may check if the USB cable is connected between the computer and machine properly, and follow the instruction on the window.

14. After searching the wireless networks, a list of wireless networks your machine has searched appears.

If you want to use the Samsung default ad-hoc setting, select the last wireless network on the list, which **Network Name(SSID)** is **portthru**

and **Signal** is **Printer Self Network**.

Then, click on **Next**.

If you want to use other ad-hoc settings, select another wireless network from the list.

 If you want to change ad-hoc settings click the **Advanced Setting** button.

- Enter the wireless Network Name:** Enter the SSID name you want (SSID is case-sensitive).
- Operation Mode:** Select **Ad-hoc**.
- Channel:** Select the channel (**Auto Setting** or 2412 MHz or 2467 MHz).
- Authentication:** Select an authentication type.
 - Open System:** Authentication is not used, and encryption may or may not be used, depending on the need for data security.
 - Shared Key:** Authentication is used. A device that has a proper WEP key can access the network.
- Encryption:** Select the encryption (None, WEP64, WEP128).
- Network Key:** Enter the encryption network key value.
- Confirm Network Key:** Confirm the encryption network key value.
- WEP Key Index:** If you are using the WEP Encryption, select the appropriate **WEP Key Index**.

 The wireless network security window appears when the ad-hoc network has security setting.

The wireless network security window appears. Select **Open System** or **Shared Key** for the authentication and click on **Next**.

- WEP (Wired Equivalent Privacy) is a security protocol preventing unauthorized access to your wireless network. WEP encrypts the data portion of each packet exchanged on a wireless network using a 64-bit or 128-bit WEP encryption key.

15.The window showing the wireless network setting appears. Check the settings and click on **Next**.

 Before entering the IP address for the machine, you must know the computer's network configuration information. If the computer's network configuration is set to DHCP, the wireless network setting should also be DHCP. Likewise, if the computer's network configuration is set to Static, the wireless network setting should also be Static.

If your computer is set to DHCP and you want to use Static wireless network setting, you must contact the network administrator to get the static IP address.

•**For the DHCP method**

If the IP address assignment method is DHCP, check if DHCP is shown in the **Wireless Network Setting Confirm** window. However, if it shows Static, click on **Change TCP/IP** to change the assignment method to **Receive IP address automatically (DHCP)**.

•**For the Static method**

If the IP address assignment method is Static, check if Static is shown in the **Wireless Network Setting Confirm** window. However, if it shows DHCP, click on **Change TCP/IP** to enter the IP address and other network configuration values for the machine.

For example:

If computer's network information is as shown below:

-IP address: 169.254.133.42

-Subnet Mask: 255.255.0.0

Then, the machine's network information should be as below:

-IP address: 169.254.133. **43**

-Subnet Mask: 255.255.0.0 (Use the computer's subnet mask.)

-Gateway: 169.254.133.1

16.The wireless network connects according to the network configuration.

17.When the wireless network setting is completed, disconnect the USB cable between the computer and machine.

18.Follow the instructions on the screen to complete the installation. After the installation is finished, click on **Quit** or **Restart**.

Setting a wireless network with network cable

Your machine is a network compatible machine. To enable your machine to work with your network you will need to perform some configuration procedures.

-  •After completing the wireless network connection, you need to install a machine driver to print from an application (See "Installing network connected machine's driver" on page 37).
- See your network administrator, or the person that set up your wireless network, for information about your network configuration.

Preparing items

Ensure you have following items ready:

- Access point
- Network-connected computer
- Software CD that was provided with your machine
- The machine installed with a wireless network interface
- Network cable

Setting IP address

Firstly, you have to set up an IP address for network printing and managements. In most cases a new IP address will be automatically assigned by a DHCP (Dynamic Host Configuration Protocol) server located on the network.

In a few situations the IP address must be set manually. This is called a static IP and is often required in corporate intranets for security reasons.

•**DHCP IP assignment:** Connect your machine to the network, and wait a few minutes for the DHCP server to assign an IP address to the machine. Then, print the **Network Configuration Report** as explained above. If the report shows that the IP address has changed, the assignment was successful. You will see the new IP address in the report.

•**Static IP assignment:** Use SetIP program to change the IP address from your computer.

In an office environment, we recommend that you contact a network administrator to set this address for you.

Printing a network configuration report

You can identify the network settings of your machine by printing a network configuration report.

To print the report:

In ready mode, press and hold the **Cancel** (Ⓢ) button for about 5 seconds. You can find your machine's MAC address and IP address.

For example:

- MAC Address: 00:15:99:41:A2:78
- IP Address: 192.0.0.192

IP setting using SetIP Program (Windows)

This program is for manually setting the network IP address of your machine using its MAC address to communicate with the machine. A MAC address is the hardware serial number of the network interface and can be found in the **Network Configuration Report**.

For using the SetIP program, disable the computer firewall before continuing by performing the following:

- 1.Open **Start > All programs > Control Panel**.
- 2.Double click on **Security Center**.
- 3.Click on **Windows Firewall**.
- 4.Disable the firewall.

Installing the program

- 1.Insert the Printer Software CD-ROM provided with your machine. When the driver CD runs automatically, close that window.
- 2.Start Windows Explorer and open the X drive. (X represents your CD-ROM drive.)
- 3.Double-click **Application > SetIP**.
- 4.Double-click **Setup.exe** to install this program.
- 5.Select a language, then click on **Next**.
- 6.Follow the instructions in the window and complete the installation.

Starting the program

- 1.Connect your machine to the network with a network cable.
- 2.Turn on the machine.
- 3.From the Windows **Start** menu, select **All Programs > Samsung Printers > SetIP > SetIP**.
- 4.Click on the  icon (third from left) in the SetIP window to open the TCP/IP configuration window.
- 5.Enter the machine's new information into the configuration window as follows. In a corporate intranet, you may need to have this information assigned by a network manager before proceeding.

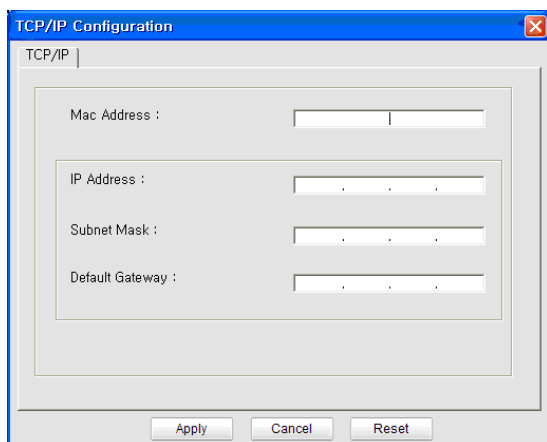

- MAC Address:** Find the machine's MAC address from the **Network Configuration Report** and enter it without the colons. For example, 00:15:99:29:51:A8 becomes 0015992951A8.
- IP Address:** Enter a new IP address for your printer. For example, if your computer's IP address is 192.168.1.150, enter 192.168.1.X. (X is number between 1 and 254 other than the computer's address.)

- Subnet Mask:** Enter the subnet mask.
- Default Gateway:** Enter the default gateway.

- 6.Click on **Apply**, and then click on **OK**. The machine will automatically print the **Network Configuration Report**. Confirm that all the settings are correct.
- 7.Click on **Exit** to close the SetIP program.
- 8.If necessary, restart the computer's firewall.

IP setting using SetIP Program (Macintosh)

For using the SetIP program, disable the computer firewall before continuing by performing the following:

-  The path and UIs may differ by Mac OS version. Refer to the Mac OS manual.

- 1.Open **System Preferences**.
- 2.Click on **Security**.
- 3.Click on the **Firewall** menu.
- 4.Turn the firewall off.

-  The following instructions may vary for your model.

- 1.Connect your machine to the network with a network cable.
- 2.Insert the Installation CD-ROM, and open the disk window, select **MAC_Installer > MAC_Printer > SetIP > SetIPApplet.html**.
- 3.Double click the file and **Safari** will automatically open, then select **Trust**. The browser will open the **SetIPApplet.html** page that shows the printer's name and IP address information.
- 4.Click on the  icon (third from left) in the SetIP window to open the TCP/IP configuration window.
- 5.Enter the machine's new information into the configuration window as follows. In a corporate intranet, you may need to have this information assigned by a network manager before proceeding.
 - MAC Address:** Find the machine's MAC address from the **Network Configuration Report** and enter it without the colons. For example, 00:15:99:29:51:A8 becomes 0015992951A8.
 - IP Address:** Enter a new IP address for your printer. For example, if your computer's IP address is 192.168.1.150, enter 192.168.1.X. (X is number between 1 and 254 other than the computer's address.)
 - Subnet Mask:** Enter the subnet mask.
 - Default Gateway:** Enter the default gateway.
- 6.Select **Apply**, then **OK**, and **OK** again. The printer will automatically print the configuration report. Confirm that all the settings are correct. **Quit Safari**. You may close and eject the installation CD-ROM. If necessary, restart the computer's firewall. You have successfully changed the IP address, subnet mask, and gateway.

Configuring the machine's wireless network

Before starting you will need to know the network name(SSID) of your wireless network and the network key if it is encrypted. This information was set when the access point (or wireless router) was installed. If you do not know about your wireless environment, please ask the person who has set up your network.

To configure wireless parameters, you can use **SyncThru™ Web Service**.

Using SyncThru™ Web Service

Before starting wireless parameter configuration, check the cable connection status.

1. Check whether or not the network cable is connected to the machine.
If not, connect the machine with a standard network cable.
2. Start a web browser such as Internet Explorer, Safari or Firefox and enter your machine's new IP address in the browser window.
For example,

 http://192.168.1.133/

3. Click on **Login** on the upper right of the SyncThru™ Web Service website.
A log-in page appears.
4. Type in the **ID** and **Password** then click on **Login**.
If it's your first time logging into SyncThru™ Web Service, type in the below default ID and password.
 - ID: admin
 - Password: sec00000
5. When the **SyncThru™ Web Service** window opens, click on **Network Settings**.
6. Click on **Wireless > Wizard**.

 **Wizard** will help you setup the wireless network configuration. However, if you want to set the wireless network directly, select **Custom**.

7. Select the one **Network Name(SSID)** in the list.
 - SSID**: SSID (Service Set Identifier) is a name that identifies a wireless network, access points, and wireless devices attempting to connect to a specific wireless network must use the same SSID. The SSID is case-sensitive.
 - Operation Mode**: **Operation Mode** refers to the type of wireless connections (See "Wireless network name and network key" on page 40).
 - Ad-hoc**: Allows wireless devices to communicate directly with each other in a peer-to-peer environment.
 - Infrastructure**: Allows wireless devices to communicate with each other through an access point.

 If your network's **Operation Mode** is **Infrastructure**, select the SSID of the access point. If the **Operation Mode** is **Ad-hoc**, select the machine's SSID. Note that "portthru" is the default SSID of your machine.

8. Click on **Next**.
If the wireless security setting window appears, enter the registered password (network key) and click on **Next**.
9. The confirmation window appears, please check your wireless setup. If the setup is right, click on **Apply**.

 Disconnect the network cable (standard or network). Your machine should then start communicating wirelessly with the network. In case of Ad-hoc mode, you can use a wireless LAN and wired LAN simultaneously.

Completing the installation

After you have installed your Samsung wireless network printer, print another copy of the Network Configuration Report and keep it for future reference. You are now ready to use your new Samsung wireless printer on your network.

 If the wireless network seems to not be working, set all the network setting to the factory defaults and try again (See "Restoring factory default settings using SyncThru™ Web Service" on page 36).

Turning the Wi-Fi network on/off

You can turn the Wi-Fi network on/off with SyncThru™ Web Service. The factory default is on.

To turn default mode, follow the following steps:

1. Check whether the network cable is connected to the machine. If not, connect the machine with a standard network cable.
2. Start a web browser such as Internet Explorer, Safari or Firefox and enter your machine's new IP address in the browser window.
For example,

 http://192.168.1.133/

3. Click on **Login** on the upper right of the SyncThru™ Web Service website.
A log-in page appears.
4. Type in the **ID** and **Password** then click on **Login**.
If it's your first time logging into SyncThru™ Web Service, type in the below default ID and password.
 - ID: admin
 - Password: sec00000
5. When the **SyncThru™ Web Service** window opens, click on **Network Settings**.
6. Click on **Wireless > Custom**.
You can also turn the Wi-Fi network on/off.

Troubleshooting

Solving problems that might occur during setting up the wireless setting and installing the machine driver

Printers Not Found

- Your machine may not be turned on. Turn on your computer and the machine.
- USB cable is not connected between your computer and machine. Connect machine to your computer using the USB cable.
- The machine does not support a wireless network. Check the machine's user's guide included on the software CD supplied with your machine and prepare a wireless network machine.

Connecting Failure - Not Found SSID

- The machine is unable to search the network name (SSID) you have selected or entered. Check the network name (SSID) on your access point and try connecting again.
- Your access point is not turned on. Turn on your access point.

Connecting Failure - Invalid Security

- You configured security incorrectly. Check the configured security on your access point and machine.

Connecting Failure - General Connection Error

- Your computer is not receiving a signal from your machine. Check the USB cable and your machine's power.

Connecting Failure - Connected Wired Network

- Your machine is connected with a wired network cable. Remove the wired network cable from your machine.

PC Connection Error

- The configured network address is unable to connect between your computer and machine.
 - For a DHCP network environment
The print receives the IP address automatically (DHCP) when computer is configured to DHCP.
 - For a Static network environment
The machine uses the static address when the computer is configured to static address.
For example:
If computer's network information is as shown below:
-IP address: 169.254.133.42
-Subnet Mask: 255.255.0.0
Then, the machine's network information should be as below:
-IP address: 169.254.133. **43**
-Subnet Mask: 255.255.0.0 (Use the computer's subnet mask.)
-Gateway: 169.254.133.1

Solving other problems

If problems occur while using the machine on a network, check the following:



For information on the access point (or wireless router), refer to its own user's guide.

- Your computer, access point (or wireless router), or machine may not be turned on.
- Check the wireless reception around the machine. If the reception is far from the machine or there is an obstacle, you might have difficulty receiving the signal.
- Cycle the power for the access point (or wireless router), machine, and computer. Sometimes cycling the power can recover network communication.
- Check whether firewall software (V3 or Norton) is blocking the communication.
If the computer and the machine is connected on the same network and it cannot be searched, firewall software might be blocking the communication. Refer to the user's guide for the software to turn it off and try searching for the machine again.
- Check whether the machine's IP address is allocated correctly. You can check the IP address by printing the network configuration report.
- Check whether the access point (or wireless router) has a configured security (password). If it has a password, refer to the access point (or wireless router) administrator.
- Check whether the machine's IP address. Reinstall the machine driver and change the settings to connect to the machine on the network. Due to the characteristics of DHCP, the allocated IP address could change if the machine is not used for a long time or if the access point has been reset.
- Check the wireless environment. You might not be able to connect to the network in the infrastructure environment where you need to type in a user's information before connecting to access point (or wireless router).
- This machine only supports IEEE 802.11 b/g/n and Wi-Fi. Other wireless communication (Bluetooth) is not supported.
- When using the Ad-hoc mode, for operating systems such as Windows Vista, you might need to set the wireless connection setting every time you use the wireless machine.
- You cannot use infrastructure mode and Ad-hoc mode at the same time for Samsung wireless network machines.

- The machine is within the range of the wireless network.
- The machine is located away from obstacles that could block the wireless signal.
Remove any large metal objects between the access point (or wireless router) and the machine.
Make sure the machine and wireless access point (or wireless router) are not separated by poles, walls, or support columns containing metal or concrete.
- The machine is located away from other electronic devices that may interfere with the wireless signal.
Many devices can interfere with the wireless signal, including a microwave oven and some Bluetooth devices.

basic setup

After installation is complete, you may want to set the machine's default settings. Refer to the next section if you would like to set or change values. This chapter gives you step-by-step instructions for setting up the machine.

This chapter includes:

- Altitude adjustment
- Setting the default tray and paper

Altitude adjustment

The print quality is affected by atmospheric pressure, which is determined by the height of the machine above sea level. The following information will guide you on how to set your machine to the best print quality or best quality of print.

Before you set the altitude value, determine the altitude where you are.

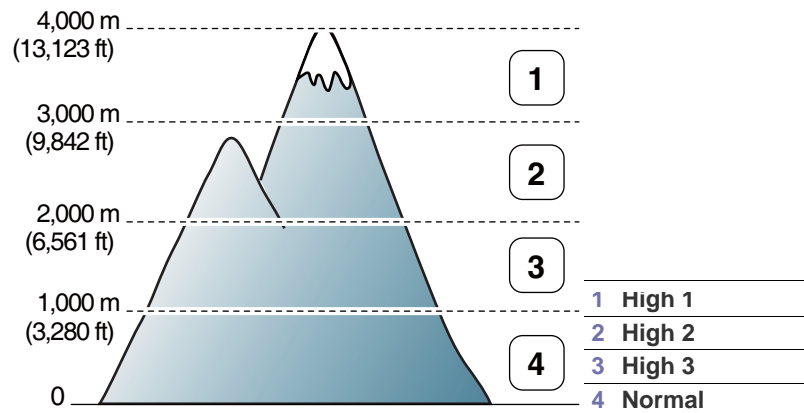

You can altitude adjustment in Printer Settings Utility.

1. Double-click the **Smart Panel** icon on the Windows task bar (or Notification Area in Linux). You can also click **Smart Panel** on the status bar in Mac OS X (See "Using the Smart Panel program" on page 69).
Or, if you are a Windows user, you can launch it from the **Start** menu, select **Programs** or **All Programs** > **Samsung Printers** > **your printer driver name** > **Smart Panel**.
2. Click **Printer Setting**.
3. Select necessary options in the **Altitude Adjustment** drop-down list.
4. Click the **Apply** button.

If your machine is connected to a network, SyncThru™ Web Service screen appears automatically. This can also be adjusted via SyncThru™ Web Service.

Setting the default tray and paper

You can select the tray and paper you would like to keep using for printing job.

- Using the power saving feature
- Changing font setting (CLP-320N(K)/CLP-321N/CLP-325W(K)/CLP-326W only)

From your computer

Windows

1. Click the Windows **Start** menu.
2. For Windows 2000, select **Settings** > **Printers**.
 - For Windows XP/Server 2003, select **Printers and Faxes**.
 - For Windows Server 2008/Vista, select **Control Panel** > **Hardware and Sound** > **Printers**.
 - For Windows 7, select **Control Panel** > **Devices and Printers**.
 - For Windows Server 2008 R2, select **Control Panel** > **Hardware** > **Devices and Printers**.
3. Right-click on your machine.
4. For Windows Server 2003/Server 2008/XP/Vista, press **Printing Preferences**.
For Windows 7/Server 2008 R2, from context menus, select the **Printing Preferences**.



If **Printing Preferences** item has a ► mark, you can select other printer drivers connected with the selected printer.

5. Click **Paper** tab.
6. Select options such as number of copies, paper size or paper type.
7. Press **OK**.



If you want to use special-sized paper such as a billing paper, select **Edit...** in the **Paper** tab in the **Printing Preferences** (See "Opening printing preferences" on page 60).

Macintosh

Macintosh does not support this function. Macintosh users need to change the default setting manually each time they want to print using other settings.

1. Open a Macintosh application and select the file you want to print.
2. Open the **File** menu and click **Print**.
3. Go to **Paper Feed** pane.
4. Set appropriate tray from which you want to print.
5. Go to **Paper** pane.
6. Set paper type to correspond to the paper loaded in the tray from which you want to print.
7. Click **Print** to print.

Linux

1. Open **Terminal Program**
2. When the Terminal screen appears, type in the following:
[root@localhost root]# lpr <FileName>

3. Select **Printer** and click **Properties...**
4. Click **Advanced** tab.
5. Select tray (source) and its options, such as paper size and type.
6. Press **OK**.

Using the power saving feature

When you will not be using the machine for a while, you can use this feature to save power.

You change power save in Printer Settings Utility.

1. Double-click the **Smart Panel** icon on the Windows task bar (or Notification Area in Linux). You can also click **Smart Panel** on the status bar in Mac OS X (See "Using the Smart Panel program" on page 69).
Or, if you are a Windows user, you can launch it from the **Start** menu, select **Programs** or **All Programs** > **Samsung Printers** > **your printer driver name** > **Smart Panel**.
2. Click **Printer Setting**.
3. Click **Setting** > **Power Save**. Select the appropriate value from the drop-down list, and then click **Apply**.

Changing font setting (CLP-320N(K)/CLP-321N/CLP-325W(K)/ /CLP-326W only)

Your machine has preset font setting depending on your region or country. If you want to change the font or set the font for special condition, such as the DOS environment, you can change the font setting as follows:

1. Double-click the **Smart Panel** icon on the Windows task bar (or Notification Area in Linux). You can also click **Smart Panel** on the status bar in Mac OS X (See "Using the Smart Panel program" on page 69).
Or, if you are a Windows user, you can launch it from the **Start** menu, select **Programs** or **All Programs** > **Samsung Printers** > **your printer driver name** > **Smart Panel**.
2. Click **Printer Setting**.
3. Click **Emulation**.
4. Confirm if **PCL** is selected in **Emulation Setting**.
5. Click **Setting**.
6. Select your preferred font in the **Symbol** set list.
7. Click **Apply**.

 Following information shows the proper font list for corresponding languages.

- Russian:** CP866, ISO 8859/5 Latin Cyrillic
- Greek:** ISO 8859/7 Latin Greek, PC-8 Latin/Greek
- Arabic & Farsi:** HP Arabic-8, Windows Arabic, Code Page 864, Farsi, ISO 8859/6 Latin Arabic

Setting the humidity mode

Print quality is affected by humidity levels. Paper may be damp if your location is a humid area: set the humidity mode.

1. Ensure that you have installed the printer driver with the provided Printer Software CD.
2. Double-click the **Smart Panel** icon on the Windows task bar (or Notification Area in Linux). You can also click **Smart Panel** on the status bar in Mac OS X.
3. Click **Printer Setting**.

 If your machine is connected to the network, you can set the humidity mode via SyncThru™ Web Service.

4. Click **Setting** > **Humidity**. Select the appropriate value from the drop-down list, and then click **Apply**.

media and tray

This chapter introduces you how to load originals and print media into your machine.

This chapter includes:

- Selecting print media
- Changing the tray size
- Loading paper in the tray
- Printing on special media
- Setting the paper size and type
- Using the output support

Selecting print media

You can print on a variety of print media, such as plain paper, envelopes, labels, and transparencies. Always use print media that meets the guidelines for use with your machine and from the appropriate tray.

Guidelines for selecting the print media

Print media that does not meet the guidelines outlined in this user's guide may cause the following problems:

- Poor print quality
- Increased paper jams
- Premature wear on the machine.
- Permanent fuser damage, not covered under warranty.

Properties, such as weight, composition, grain, and moisture content, are important factors that affect the machine's performance and the output quality. When you choose print materials, consider the following:

- The type, size and weight of the print media for your machine are described later in this section.
- Desired outcome: The print media you choose should be appropriate for your project.
- Brightness: Some print media are whiter than others and produce sharper, more vibrant images.
- Surface smoothness: The smoothness of the print media affects how crisp the printing looks on the paper.



- Some print media may meet all of the guidelines in this section and still not produce satisfactory results. This may be the result of the sheets characteristics, improper handling, unacceptable temperature and humidity levels, or other variables over which cannot be controlled.
- Before purchasing large quantities of print media, ensure that it meets the required specifications in this user's guide and meets your output requirements.



- Using print media that does not meet these specifications may cause problems or require repairs. Such repairs are not covered by Samsung's warranty or service agreements.
- Make sure not to use the inkjet photo paper with this machine. It could cause damage to the machine.
- Using inflammable print media can cause a fire.
- Use designated print media (See "Print media specifications" on page 92).



The use of inflammable media or foreign materials left in the printer may lead to overheating of the unit and, in rare cases may cause a fire.

Media sizes supported in each mode

Mode	Size	Type	Source
Simplex printing	For details about paper size, see "Print media specifications" on page 92.	For details about paper type, see "Print media specifications" on page 92.	Tray
Duplex printing (Manual)^a	Letter, Legal, Oficio, US Folio, A4, ISO B5, JIS B5, Executive, A5, A6	Plain, Thick, Cotton, Color, Preprinted, Recycled, CardStock, Archive	Tray

a. 75 to 90 g/m² (20-24 lbs bond) only

Changing the tray size

To load different sizes of paper, such as Legal-sized paper, you need to adjust the paper guides to extend the paper tray.

To change the tray size to other size, you must adjust the paper length/width guides properly.

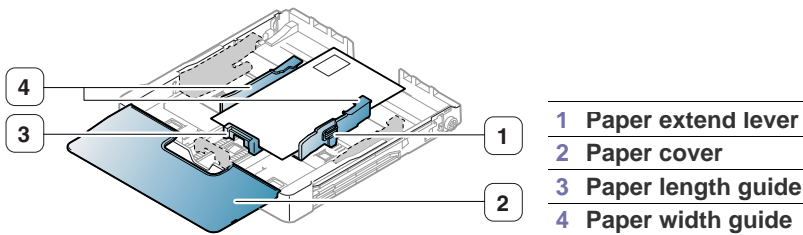

1. Pull the tray out of the machine. Open the paper cover and remove paper from the tray if necessary.

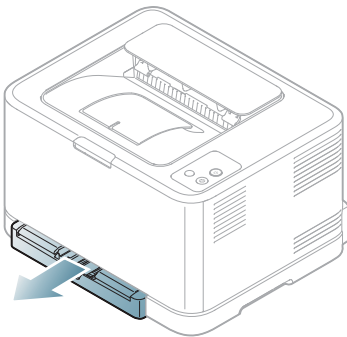

2. Pressing and unlatching the guide lock in the tray, pull the tray out manually.

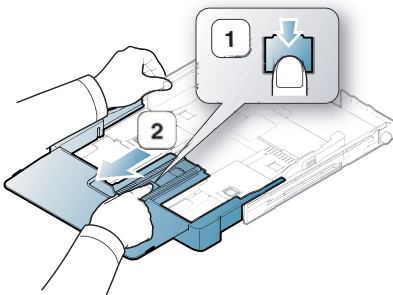

3. Place paper with the side you want to print facing up.

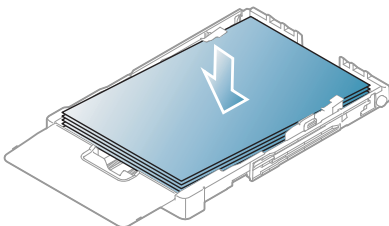

4. Slide the paper length guide until it lightly touches the end of the paper stack. Squeeze the paper width guide and slide it to the edge of the paper stack without causing it to bend.

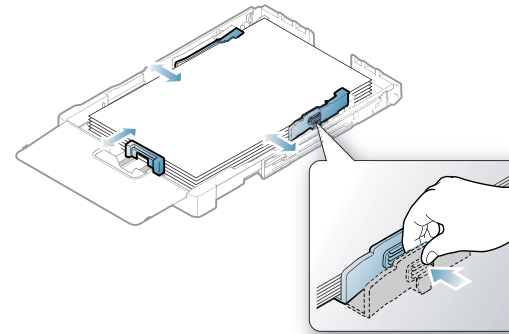

For paper smaller than Letter-sized, return the paper guides to their original positions and adjust the paper length guide and paper width guide.

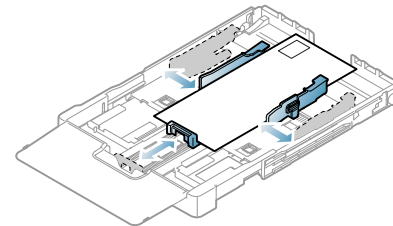

If the paper that you need to print is shorter than length 222 mm (8.74 inches), press and unlatch the guide lock in the tray, push the tray in manually. Adjust the paper length guide and paper width guide.

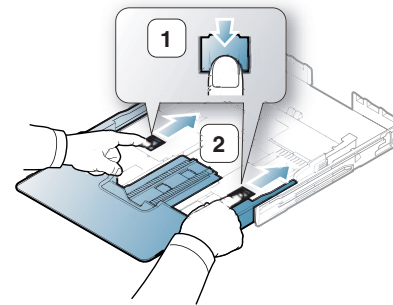

- Do not push the paper width guides far enough to cause the materials to warp.
- If you do not adjust the paper width guides, it may cause paper jams.

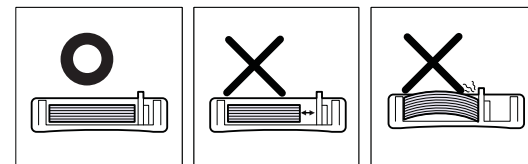

•Do not use a paper with more than 6 mm (0.24 inch.) curl.

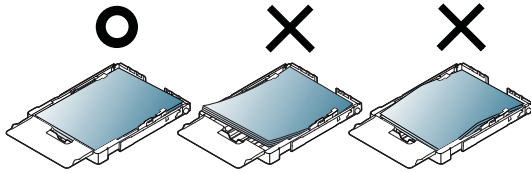

5. Close the paper cover.

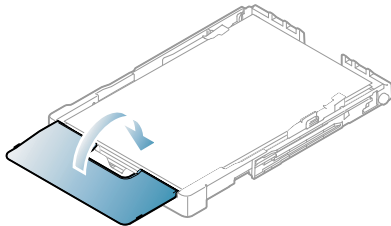

6. Slide the tray back into the machine until it clicks.

7. Set the paper type and size for the tray ("Setting the paper size and type" on page 58).

 If you experience problems with paper feeding, check whether the paper meets the media specifications. Then, try placing one sheet at a time in tray (See "Print media specifications" on page 92 or see "Printing on special media" on page 56).

The tray is preset to Letter or A4 size, depending on your country. To change the size to A4 or Letter, you must adjust the lever and paper width guide properly.

1. Pull the tray out of the machine. Open the paper cover and remove paper from the tray if necessary.
2. If you want to change the size to Letter, hold the lever at the back of the tray, and rotate the lever clockwise.

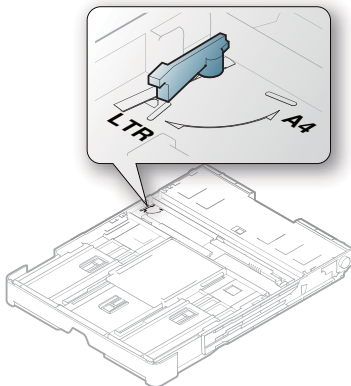

3. Squeeze the paper width guide and slide it to the edge of the lever.

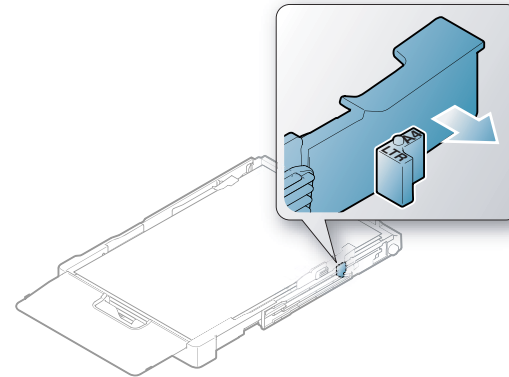

 If you want to change the size to A4, first move the paper width guide to left and rotate the lever counterclockwise. If you force the lever, it could damage the tray.

Loading paper in the tray

In the tray

1. Pull out the paper tray. Adjust the tray size to the media size you are loading (See "Changing the tray size" on page 53).
2. Flex or fan the edge of the paper stack to separate the pages before loading the paper.

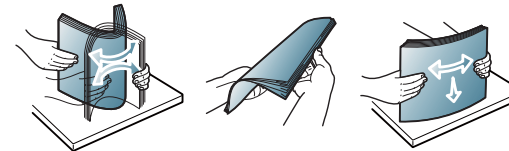

3. Place the paper with the side you want to print facing up.
4. Squeeze the tray paper guides and adjust them to the width and length of the paper. Do not force them too much or the paper will be bent result in a paper jam or skew.

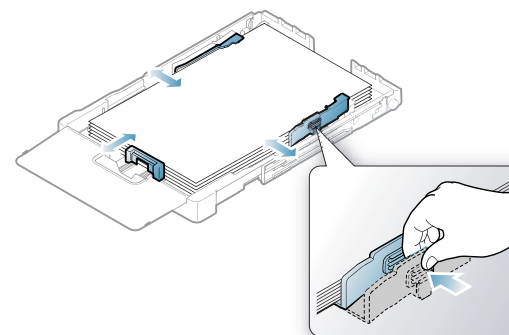

5. Close the paper cover.

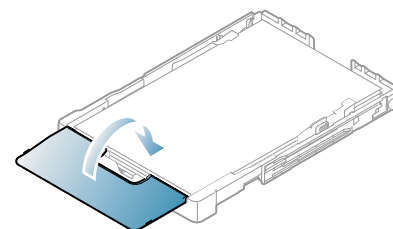

6. Insert the tray back into the machine.
7. To print in application, open an application and start the print menu.
8. Open **Printing Preferences** (See "Opening printing preferences" on page 60).
9. Press the **Paper** tab in **Printing Preferences** and select an appropriate paper type, size and source.
10. Press **OK**.
11. Start printing in application.

 If you experience problems with paper feeding, check whether the paper meets the media specification. Then, try placing one sheet at a time in the tray (See "Print media specifications" on page 92).

The tray is preset to Letter or A4 size, depending on your country. To change the size to A4 or Letter, you must adjust the lever and paper width guide properly.

1. Pull the tray out of the machine. Open the paper cover and remove paper from the tray if necessary.
2. If you want to change the size to Letter, hold the lever at the back of the tray, and rotate the lever clockwise.

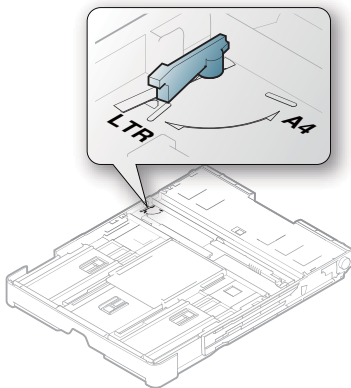

3. Squeeze the paper width guide and slide it to the edge of the lever.

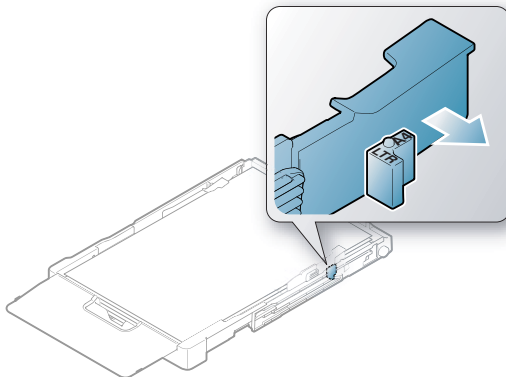

 If you want to change the size to A4, first move the paper width guide to left and rotate the lever counterclockwise. If you force the lever, it could damage the tray.

Manual feeding in the tray

To load different sizes of paper such as envelope, transparency, labels or custom-sized paper, you need to adjust the paper guides for manual feeding in the tray.

To use manual feeding in the tray, you must adjust the paper length/width guide properly.

Tips on using the manual feeding method

Tips on manual feeding in the tray

- If you select **Manual Feeder** for **Source** from your software application, you need to press **Cancel** (Ⓢ) button each time you print a page. Load only one type, size and weight of print media at a time in the tray.
- To prevent paper jams, do not add media while printing. This also applies to other types of print media.
- Print media should be loaded face up with the top edge going into the tray first and be placed in the center of the tray.
- Always load the use recommended print media only to avoid paper jams and print quality problems (See "Print media specifications" on page 92).
- Flatten any curl on postcards, envelopes and labels before loading them into the tray.

1. Pull the tray out of the machine. Open the paper cover and remove paper from the tray if necessary.

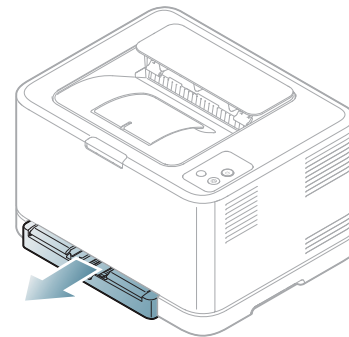

2. Place paper with the side you want to print facing up.

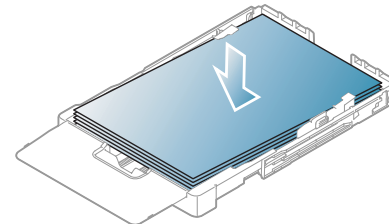

3. Squeeze the tray paper width guided and adjust them to the width of the paper until it lightly touches the end of the paper stack. Do not force too much, or the paper will bend resulting in a paper jam or skew.

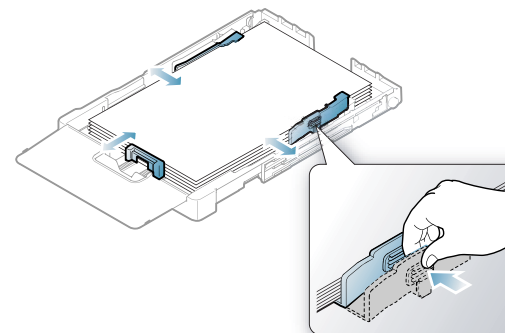

For paper smaller than Letter-sized, return the paper guides to their original positions and adjust the paper length guide and paper width

guide.

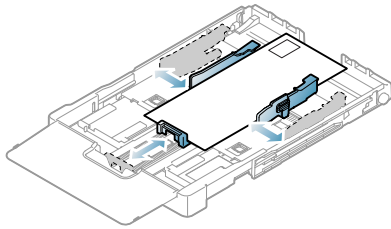

If the paper that you need to print is shorter than length 222 mm (8.74 inches), press and unlatch the guide lock in the tray, push the tray in manually. Adjust the paper length guide and paper width guide.

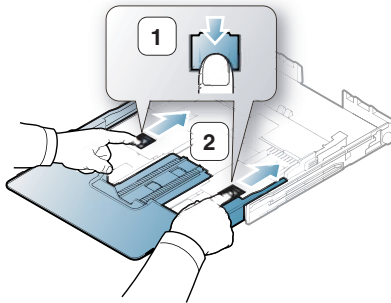

- Do not push the paper width guides far enough to cause the materials to warp.
- If you do not adjust the paper width guides, it may cause paper jams.

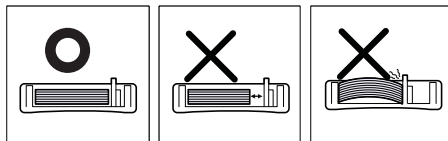

• Do not use a paper with more than 6 mm (0.24 inch.) curl.

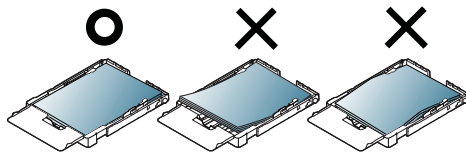

4. Close the paper cover.

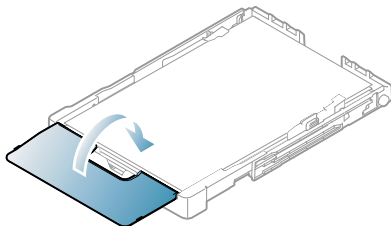

5. Slide the tray back into the machine until it clicks.
6. To print in application, open an application and start the print menu.
7. Open **Printing Preferences** (See "Opening printing preferences" on page 60).
8. Press the **Paper** tab in **Printing Preferences**, and select an appropriate paper type.

- For example, if you want to use a label, set the paper type to **Label**.

9. Select **Manual Feeder** in paper source, then press **OK**.
10. Start printing in application.

- If you are printing multiple pages, load the next sheet after the first page prints out, and press the **Cancel** (⊘) button. Repeat this step for every page to be printed.

Printing on special media

The table below shows the available special media for each tray.

- When using special media, we recommend you feed one paper at a time. Check the maximum input number of media for each tray (See "Print media specifications" on page 92).

Types	Tray	Manual feeding in the tray
Plain	•	•
Thick	•	•
Thin	•	•
Cotton	•	•
Color	•	•
Preprinted	•	•
Recycled	•	•
Envelope		•
Transparency		•
Labels		•
CardStock		•
Bond		•
Archive		•
Glossy Photo		•
Matte Photo		•

(•: Supported, Blank: Not supported)

The following media types are shown in the **Printing Preferences**. This paper type option allows you to set the type of paper to be loaded in the tray. Selecting the appropriate media will let you get the best printout quality. Selecting inappropriate media can result in poor print quality.

- **Plain:** Normal plain paper. Select this type if your printing on 70 to 90 g/m² (19 to 24 lbs bond).
- **Thick:** 90 to 105 g/m² (24 to 28 lbs bond) thick paper.
- **Thin:** 60 to 70 g/m² (16 to 19 lbs bond) thin paper.
- **Cotton:** 75 to 90 g/m² (20 to 24 lbs bond) cotton paper.
- **Color:** 75 to 90 g/m² (20 to 24 lbs bond) color-backgrounded paper.
- **Preprinted:** 75 to 90 g/m² (20 to 24 lbs bond) preprinted/letterhead paper.
- **Recycled:** 75 to 90 g/m² (20 to 24 lbs bond) recycled paper.
- When you use recycled paper, printouts might be wrinkled and/or jamming may occur due to excessive curl.
- **Envelope:** 75 to 90 g/m² (20 to 24 lbs bond) envelope.
- **Transparency:** 0.104 to 0.124 mm (0.004094 to 0.004882 inches) transparency paper.
- **Labels:** 120 to 150 g/m² (32 to 40 lbs bond) label.

- **CardStock:** 105 to 163 g/m² (28 to 43 lbs bond) cardstock.
- **Bond:** 105 to 120 g/m² (28 to 32 lbs bond) bond.
- **Archive:** 70 to 90 g/m² (19 to 24 lbs bond). If you need to keep the print-out for a long time, such as for archives.
- **Glossy Photo:** 111 to 220 g/m² (30 to 58 lbs bond) glossy photo paper.
- **Matte Photo:** 111 to 220 g/m² (30 to 58 lbs bond) matte photo paper.

Envelopes

Successful printing on envelopes depends upon the quality of the envelopes.

To print an envelope, place it flap side down with the stamp area on the top left side.

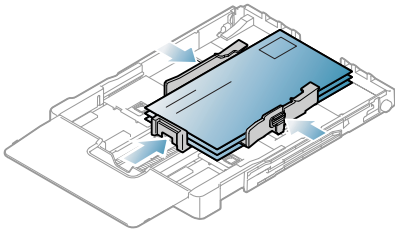

- When selecting envelopes, consider the following factors:
 - Weight:** The weight of the envelope paper should not exceed 90 g/m² otherwise, jams may occur.
 - Construction:** Prior to printing, envelopes should lie flat with less than 6 mm (0.24 inch.) curl, and should not contain air.
 - Condition:** Envelopes should not be wrinkled, nicked, either damaged.
 - Temperature:** Use envelopes that are compatible with the heat and pressure of the machine during operation.
- Use only well-constructed envelopes with sharp-and well-creased folds.
- Do not use stamped envelopes.
- Do not use envelopes with clasps, snaps, windows, coated lining, self-adhesive seals, or other synthetic materials.
- Do not use damaged or poorly made envelopes.
- Be sure the seam at both ends of the envelope extends all the way to the corner of the envelope.

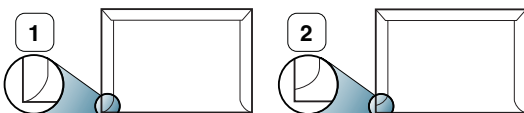

- 1 Acceptable
- 2 Unacceptable

- Envelopes with a peel-off adhesive strip or with more than one flap that folds over to seal must use adhesives compatible with the machine's fusing temperature about 170°C (338 °F) for 0.1 second. The extra flaps and strips might cause wrinkling, creasing, or jams and may even damage the fuser.
- For the best print quality, position margins no closer than 15 mm (0.59 inch.) from the edges of the envelope.
- Avoid printing over the area where the envelope's seams meet.

Transparencies

To avoid damaging the machine, use only transparencies designed for laser printers.

- In case of color printing using transparencies, the picture quality would be lower than mono printing when the printouts are used on the

overhead projector.

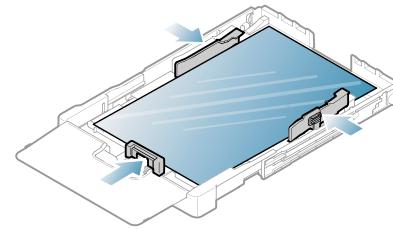

- Transparencies used in the machine must be able to withstand machine's fusing temperature.
- Place them on a flat surface after removing them from the machine.
- Do not leave unused transparencies in the paper tray for long periods of time. Dust and dirt may accumulate on them, resulting in spotty printing.
- To avoid smudging caused by fingerprints, handle transparencies carefully.
- To avoid fading, do not expose printed transparencies to prolonged sunlight.
- Ensure that transparencies are not wrinkled, curled, or have any torn edges.
- Do not use transparencies that separate from the backing sheet.
- To prevent transparencies from sticking to each other, do not let the printed sheets stack up as they are begin printed out.
- **Recommended media:** Xerox 3R91331 (A4), Xerox 3R2780 (Letter) Base type transparency (ex. Xerox 3R91331) results in better image and paper handling quality than paper backed (ex. Xerox 3R3028) or removable stripe (3R3108) ones.
 - Transparency with static electricity can cause image quality problems.
 - Depending on the selection or storage conditions of the transparency, jam or image scratch might occur.

Labels

To avoid damaging the machine, use only labels designed for use in laser machines.

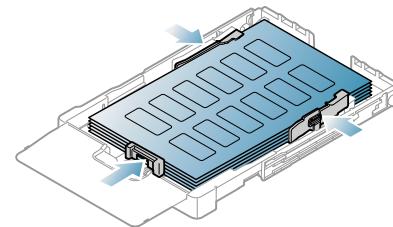

- When selecting labels, consider the following factors:
 - Adhesives:** The adhesive material should be stable at your machine's fusing temperature (about 170°C (338 °F)).
 - Arrangement:** Only use labels with no exposed backing between them. Labels can peel off sheets that have spaces between the labels, causing serious jams.
 - Curl:** Prior to printing, labels must lie flat with no more than 13 mm (0.51 inch.) of curl in any direction.
 - Condition:** Do not use labels with wrinkles, bubbles, or other indications of separation.
- Make sure that there is no exposed adhesive material between labels. Exposed areas can cause labels to peel off during printing, which can cause paper jams. Exposed adhesive can also cause damage to machine components.

- Do not run a sheet of labels through the machine more than once. The adhesive backing is designed for only a single pass through the machine.
- Do not use labels that are separating from the backing sheet or are wrinkled, bubbled, or otherwise damaged.

Card stock/Custom-sized paper

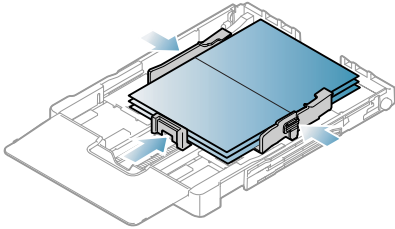

- Do not print on media smaller than 76 mm (3.00 inches) wide or 152.4 mm (6.00 inches) long.
- In software applications, set margins at least 6.4 mm (0.25 inches) away from the edges of the material.

Letterhead/Preprinted paper

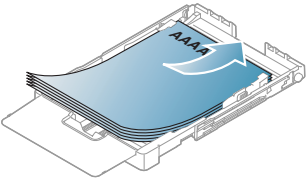
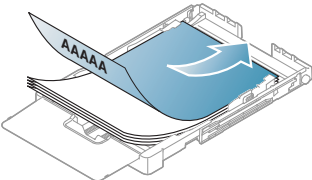
Single-sided	double-sided
Face up 	Face down 

- Letterhead/ Preprinted paper must be printed with heat-resistant ink that will not melt, vaporize, or release hazardous emissions when subjected to the machine's fusing temperature for 0.1 second. Check your machine's specification to view the fusing temperature about 170°C (338 °F).
- Letterhead/ Preprinted paper ink must be non-flammable and should not adversely affect machine rollers.
- Forms and letterhead should be sealed in a moisture-proof wrapping to prevent changes during storage.
- Before you load letterhead/preprinted paper, verify that the ink on the paper is dry. During the fusing process, wet ink can come off preprinted paper, reducing print quality.

Recycled paper

When loading recycled paper, printed side should be facing up with an uncurled edge at the front. If you experience problems with paper feed, turn the paper around. Note that print quality is not guaranteed.

- Recycled paper must be printed with heat-resistant ink that will not melt, vaporize or release hazardous emissions when subjected to the machine's fusing temperature for 0.1 second. Check your machine's specification to view the fusing temperature about 170°C(338 °F).
- Recycled paper ink must be non-flammable and should not adversely affect machine rollers.
- Before you load recycled paper, verify that the ink on the paper is dry. During the fusing process, wet ink can come off recycled paper, reducing print quality.

Glossy photo

 Load one paper in the tray at a time, glossy side facing up.

- Recommended media: Glossy paper (Letter) for this machine by **HP Brochure Paper** (Product: Q6611A).
- Recommended media: Glossy paper (A4) for this machine by **HP Superior Paper 160 glossy** (Product: Q6616A).

Matte photo

 Load one paper in the tray at a time, side to be printed facing up.

Setting the paper size and type

After loading paper in the paper tray, you need to set the paper size and type using the printer driver. Follow these steps to make your changes permanent.

 The following procedure is for Windows XP. For other Windows OS, refer to the corresponding Windows User's Guide or online help.

1. Click the **Start** button on the computer screen.
2. Select **Printers and Faxes**.
3. Right-click on the printer icon and select **Printing Preferences**.
4. Click the **Paper** tab and change the setting on **Paper Options**.
5. Click **OK**.

Using the output support

The printed pages stack on the output tray, and the output support will help the printed pages align.

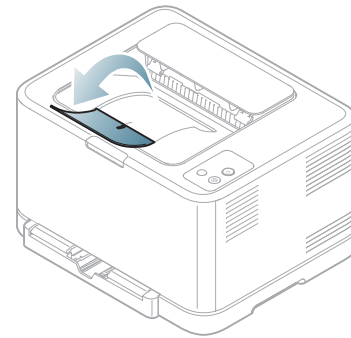

1 Output support

 If you continuously print many pages, the surface of the output tray may become hot. Be careful not to touch the surface, and especially keep children away from the surface.

This chapter explains common printing tasks.

This chapter includes:

- Introducing useful software program
- Printer driver features
- Basic printing
- Opening printing preferences
- Using help
- Using special print features

 The procedures in this chapter are mainly based on Windows XP.

Introducing useful software program

Samsung AnyWeb Print

This tool helps you to screen-capture, preview, scrap and print the screen of Windows Internet Explorer more easily, when you use the ordinary program. Click **Start > All programs > Samsung Printers > Samsung AnyWeb Print > Download the latest version** to link the website where the tool is available for the download. This tool is available only for Windows operating systems.

Samsung Easy Color Manager

This program helps users to adjust color as they like. You can adjust the printout color as they see them on the monitor. The adjusted color can be stored on the printer driver and applied to printouts. Click **Start > All programs > Samsung Printers > Samsung Easy Color Manager > Download the latest version** to link the website where the tool is available for the download. This tool is available only for Windows and Macintosh operating systems.
(<http://solution.samsungprinter.com/personal/colormanager>)

Printer driver features

Your printer drivers support the following standard features:

- Paper orientation, size, source, and media type selection
- Number of copies

In addition, you can use various special printing features. The following table shows a general overview of features supported by your printer drivers:

 Some models or operating systems may not support some of the feature(s) in the following table.

- Changing the default print settings
- Setting your machine as a default machine
- Printing to a file (PRN)
- Macintosh printing
- Linux printing





Printer driver

Feature	Windows
Print quality option	•
Poster printing	•
Multiple pages per sheet	•
Booklet printing (manual)	•
Fit to page printing	•
Reduce and enlarge printing	•
Watermark	•
Overlay	•
Double-sided printing (manual)	•

(•: Supported, Blank: Not supported)

Basic printing

Your machine allows you to print from various Windows, Macintosh, or Linux applications. The exact steps for printing a document may vary depending on the application you use.

-  •Your **Printing Preferences** window that appears in this user's guide may differ depending on the machine in use. However, the composition of the **Printing Preferences** window is similar. Check the operating system(s) that are compatible with your machine. Refer to the OS compatibility section of Printer Specifications (See "System requirements" on page 29).
- When you select an option in **Printing Preferences**, you may see a warning mark, , or . An exclamation mark () means you can select that certain option but it is not recommended, and () mark means you cannot select that option due to the machine's settings or environment.

The following procedure describes the general steps required for printing from various Windows applications.

-  Macintosh basic printing, see "Macintosh printing" on page 65.
Linux basic printing, see "Linux printing" on page 66.

The following **Printing Preferences** window is for Notepad in Windows XP. Your **Printing Preferences** window may differ, depending on your operating system or the application you are using.

1. Open the document you want to print.
2. Select **Print** from the **File** menu. The **Print** window appears.
3. Select your machine from the **Select Printer** list.

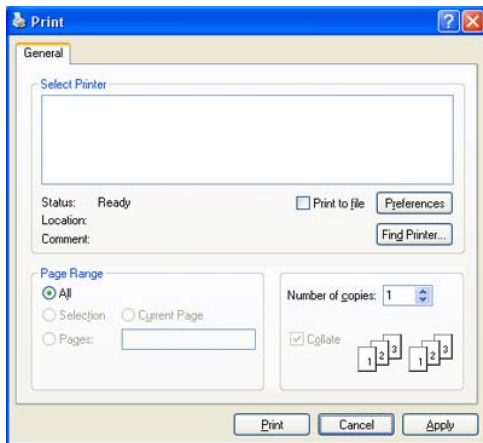

You can select the basic print settings including the number of copies and the print range from the **Print** window.

 To take advantage of the printer features provided by your printer driver, click **Properties** or **Preferences** in the application's **Print** window to change the print setting (See "Opening printing preferences" on page 60).

4. To start the print job, click **OK** or **Print** in the **Print** window.

 If you are using Windows Internet Explorer, the **Samsung AnyWeb Print** tool will save your time for screen-captured images or printing the image. Click **Start > All programs > Samsung Printers > Samsung AnyWeb Print** to link the website where the tool is available for the download.

Canceling a print job



If the print job is waiting in a print queue or print spooler, cancel the job as follows.

1. Click the Windows **Start** menu.
2. For Windows 2000, select **Settings > Printers**.
 - For Windows XP/Server 2003, select **Printers and Faxes**.
 - For Windows Server 2008/Vista, select **Control Panel > Hardware and Sound > Printers**.
 - For Windows 7, select **Control Panel > Devices and Printers**.
 - For Windows Server 2008 R2, select **Control Panel > Hardware > Devices and Printers**.
3. For Windows 2000, XP, Server 2003, Vista and Server 2008, double-click your machine.

For Windows 7 and Windows Server 2008 R2, right-click your printer icon > context menus > **See what's printing**.

 If **See what's printing** item has a ► mark, you can select other printer drivers connected with selected printer.

4. From the **Document** menu, select **Cancel**.

 You can also access this window by simply double-clicking the machine icon () in the Windows task bar.

You can also cancel the current job by pressing **Cancel** (Ⓢ) button on the control panel.

Opening printing preferences

You can preview the settings you selected on the upper right of the **Printing Preferences**.

1. Open the document you want to print.
2. Select **Print** from the **File** menu. The **Print** window appears.
3. Select your machine from the **Select Printer**.
4. Click **Properties** or **Preferences**.

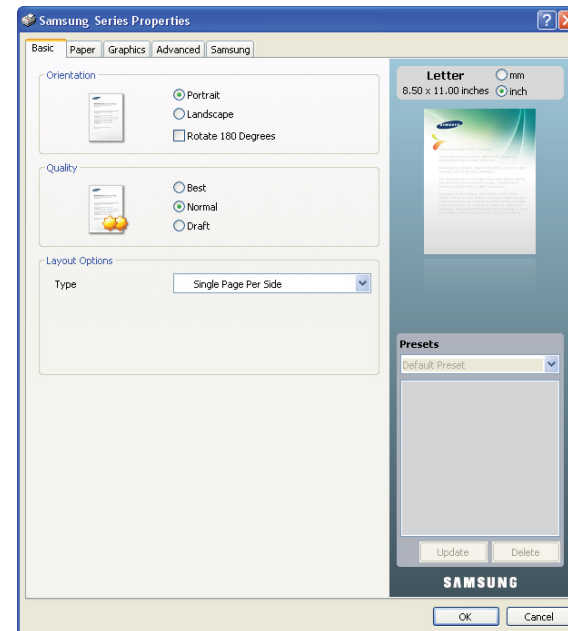

Using a favorite setting

The **Presets** option, which is visible on each of the preferences tab except for the **Samsung** tab, allows you to save the current preferences for future use.

To save a **Presets** item:

1. Change the settings as needed on each tab.
2. Enter a name for the item in the **Presets** input box.

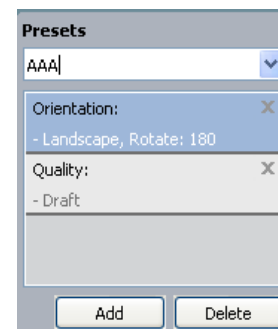

3. Click **Add**. When you save **Presets**, all current driver settings are saved. If you click **Add**, the **Add** button changes to the **Update** button. Select more options and click **Update**, settings will be added to the **Presets** you made. To use a saved setting, select it from the **Presets** drop-down list. The machine is now set to print according to the setting you selected.

To delete saved settings, select it from the **Presets** drop-down list and click **Delete**.

You can also restore the printer driver's default settings by selecting **Default Preset** from the **Presets** drop-down list.

Using help

Click the question mark on the upper-right corner of the window and click on the topic you want to know about. Then a pop-up window appears with information about that option's feature which is provided from the driver.



If you want to search information via a keyword, click the **Samsung** tab in the **Printing Preferences** window, and enter a keyword in the input line of the **Help** option. To get information about supplies, driver update or registration and so on, click appropriate buttons.

Using special print features

Special print features include:

- "Printing multiple pages on one sheet of paper" on page 61.
- "Printing posters" on page 61.
- "Printing booklets (Manual)" on page 61.
- "Printing on both sides of the paper (Manual)" on page 62.
- "Change percentage of your document" on page 62.
- "Fitting your document to a selected paper size" on page 62.
- "Using watermarks" on page 62.
- "Using overlay" on page 63.
- "Graphics tab options" on page 63.

Printing multiple pages on one sheet of paper

You can select the number of pages to print on a single sheet of paper. To print more than one page per sheet, the pages will be reduced in size and arranged in the order you specify. You can print up to 16 pages on one sheet.

1. To change the print settings from your software application, access **Printing Preferences** (See "Opening printing preferences" on page 60).
2. Click the **Basic** tab, select **Multiple Pages Per Side** in the **Type** drop-down list.
3. Select the number of pages you want to print per sheet (2, 4, 6, 9, or 16) in the **Pages per Side** drop-down list.
4. Select the page order from the **Page Order** drop-down list, if necessary.
5. Check **Print Page Border** to print a border around each page on the sheet.
6. Click the **Paper** tab, select the **Size, Source** and **Type**.
7. Click **OK** or **Print** until you exit the **Print** window.

Printing posters

This feature allows you to print a single-page document onto 4, 9 or 16 sheets of paper, for the purpose of pasting the sheets together to form one poster-size document.

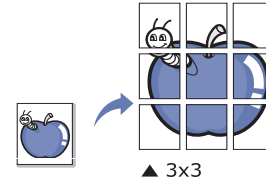

1. To change the print settings from your software application, access **Printing Preferences** (See "Opening printing preferences" on page 60).
2. Click the **Basic** tab, select **Poster Printing** in the **Type** drop-down list.
3. Select the page layout you want.
Available layouts:
 - **Poster 2x2**: Document will be enlarged and be divided into 4 pages.
 - **Poster 3x3**: Document will be enlarged and be divided into 9 pages.
 - **Poster 4x4**: Document will be enlarged and be divided into 16 pages.
4. Select the **Poster Overlap** value. Specify **Poster Overlap** in millimeters or inches by selecting the radio button on the upper right of **Basic** tab to make it easier to paste the sheets together.

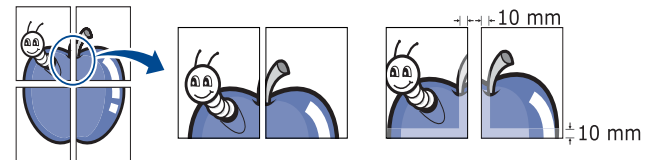



5. Click the **Paper** tab, select the **Size, Source**, and **Type**.
6. Click **OK** or **Print** until you exit the **Print** window.
7. You can complete the poster by pasting the sheets together.

Printing booklets (Manual)

This feature prints your document on both sides of a paper and arranges the pages so that the paper can be folded in half after printing to produce a booklet.

 If you want to make a booklet, you need to print on Letter, Legal, A4, US Folio or Oficio sized print media.



1. To change the print settings from your software application, access the **Printing Preferences** (See "Opening printing preferences" on page 60).
2. Click the **Basic** tab, select **Booklet Printing** from the **Type** drop-down list.
3. Click the **Paper** tab, select the **Size, Source**, and **Type**.
 The **Booklet Printing** option is not available for all paper sizes. In order to find out the available paper size for this feature, select the available paper size in the **Size** option on the **Paper** tab.
If you select an unavailable paper size, this option can be automatically canceled. Select only available paper. (paper without  or  mark).
4. Click **OK** or **Print** until you exit the **Print** window.
5. After printing, fold and staple the pages.

Printing on both sides of the paper (Manual)

You can print on both sides of a paper (duplex). Before printing, decide how you want your document oriented. You can use this feature with Letter, Legal, A4, US Folio or Oficio sized paper (See "Print media specifications" on page 92).

 We recommend not to print on both sides of special media, such as labels, envelopes, or thick paper. It may cause a paper jam or damage the machine.

1. To change the print settings from your software application, access **Printing Preferences** (See "Opening printing preferences" on page 60).
2. Click the **Advanced** tab.
3. From the **Double-Sided Printing (Manual)** section, select the binding option you want.

•None

•**Long Edge:** This option is the conventional layout used in bookbinding.

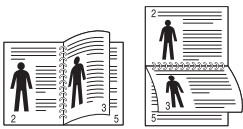

•**Short Edge:** This option is the conventional layout used in calendars.

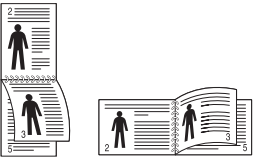

4. Click the **Paper** tab, select the **Size**, **Source**, and **Type**.
5. Click **OK** or **Print** until you exit the **Print** window.

 If your machine does not have a duplex unit, you should complete the printing job manually. The machine prints every other page of the document first. After that, a message appears on your computer. Follow the on-screen instructions to complete the printing job.

Change percentage of your document

You can change the size of a document to appear larger or smaller on the printed page by typing in a percentage you want.

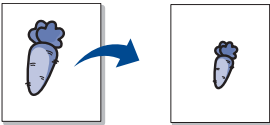

1. To change the print settings from your software application, access **Printing Preferences** (See "Opening printing preferences" on page 60).
2. Click the **Paper** tab.
3. Enter the scaling rate in the **Percentage** input box.
You can also click the up/down arrows to select the scaling rate.
4. Select the **Size**, **Source**, and **Type** in **Paper Options**.
5. Click **OK** or **Print** until you exit the **Print** window.

Fitting your document to a selected paper size

This feature allows you to scale your print job to any selected paper size regardless of the document size. This can be useful when you want to check fine details on a small document.

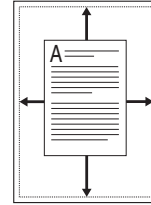

1. To change the print settings from your software application, access **Printing Preferences** (See "Opening printing preferences" on page 60).
2. Click the **Paper** tab.
3. Select the paper size you want from the **Fit to Page**.
4. Select the **Size**, **Source** and **Type** in **Paper Options**.
5. Click **OK** or **Print** until you exit the **Print** window.

Using watermarks

The watermark option allows you to print text over an existing document. For example, you use it when you want to have large gray letters reading "DRAFT" or "CONFIDENTIAL" printed diagonally across the first page or all pages of a document.

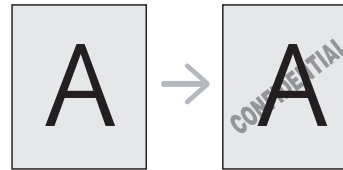

There are several predefined watermarks that come with the machine. They can be modified, or you can add new ones to the list.

Using an existing watermark

1. To change the print settings from your software application, access **Printing Preferences** (See "Opening printing preferences" on page 60).
2. Click the **Advanced** tab, and select the desired watermark from the **Watermark** drop-down list. You will see the selected watermark in the preview image.
3. Click **OK** or **Print** until you exit the print window.

Creating a watermark

1. To change the print settings from your software application, access **Printing Preferences** (See "Opening printing preferences" on page 60).
2. From the **Advanced** tab, select **Edit** from the **Watermark** drop-down list. The **Edit Watermarks** window appears.
3. Enter a text message in the **Watermark Message** box. You can enter up to 256 characters. The message displays in the preview window.
When the **First Page Only** box is checked, the watermark prints on the first page only.
4. Select watermark options.
You can select the font name, style, size, and shade from the **Font Attributes** section, as well as set the angle of the watermark from the **Message Angle** section.
5. Click **Add** to add a new watermark to the **Current Watermarks** list.

6. When you have finished, click **OK** or **Print** until you exit the **Print** window.

To stop printing the watermark, select **None** from the **Watermark** drop-down list.

Editing a watermark

1. To change the print settings from your software application, access **Printing Preferences** (See "Opening printing preferences" on page 60).
2. Click the **Advanced** tab, select **Edit...** from the **Watermark** drop-down list. The **Edit Watermarks** window appears.
3. Select the watermark you want to edit from the **Current Watermarks** list and change the watermark message and options.
4. Click **Update** to save the changes.
5. Click **OK** or **Print** until you exit the **Print** window.

Deleting a watermark

1. To change the print settings from your software application, access **Printing Preferences** (See "Opening printing preferences" on page 60).
2. Click the **Advanced** tab, select **Edit...** from the **Watermark** drop-down list. The **Edit Watermarks** window appears.
3. Select the watermark you want to delete from the **Current Watermarks** list and click **Delete**.
4. Click **OK** or **Print** until you exit the **Print** window.

Using overlay

An overlay is content you store on your hard disk drive that can be superimposed over any document you print. An overlay is often used to take the place of letterhead paper. Rather than using preprinted letterhead, you can create an overlay containing exactly the same information that is currently on your letterhead. To print a letter with your company's letterhead, you do not need to load preprinted letterhead paper in the machine, instead you can just print the letterhead overlay on your document.



Creating a new page overlay

To use a page overlay, you must create a new page overlay file containing your content.

1. Create or open a document containing the content you want to use in a new page overlay. Position the items exactly where you want them to appear when they are added to the original.
2. To save the document as an overlay, access **Printing Preferences** (See "Opening printing preferences" on page 60).
3. Click the **Advanced** tab, and select **Edit...** from the **Text** drop-down list. The **Edit Overlay** window appears.
4. In the **Edit Overlay** window, click **Create**.
5. In the **Save As** window, type a name of up to eight characters in the **File name** box. Select the destination path, if necessary. (The default is C:\FormOver.)
6. Click **Save**. The name appears on the **Overlay List**.
7. Click **OK** or **Print** until you exit the **Print** window.

8. The file is not printed. Instead, it is stored on your computer hard disk drive.

 The overlay document size must match same as the document you print. Do not create an overlay with a watermark.

Using a page overlay

After an overlay has been created, it is ready to be printed with your document. To print an overlay with a document:

1. Create or open the document you want to print.
 2. To change the print settings from your software application, access **Printing Preferences** (See "Opening printing preferences" on page 60).
 3. Click the **Advanced** tab.
 4. Select the desired overlay from the **Text** drop-down list.
 5. If the overlay file you want does not appear in the **Text** drop-down list, select **Edit...** from the list and click **Load**. Select the overlay file you want to use.
If you have stored the overlay file you want to use in an external source, you can also load the file when you access the **Open** window.
After you select the file, click **Open**. The file appears in the **Overlay List** box and is available for printing. Select the overlay from the **Overlay List** box.
 6. If necessary, check **Confirm Page Overlay When Printing** box. If this box is checked, a message window appears each time you submit a document for printing, asking you to confirm that you wish to print an overlay on your document.
If this box is not checked and an overlay has been selected, the overlay automatically prints with your document.
 7. Click **OK** or **Print** until you exit the **Print** window.
The selected overlay prints over your document.
-  The resolution of the overlay document must match the resolution of the original print job.

Deleting a overlay

You can delete page overlays that you no longer use.

1. In the **Printing Preferences** window, click the **Advanced** tab.
2. Select **Edit...** in the **Overlay** drop-down list.
3. Select the overlay you want to delete from the **Overlay List** box.
4. Click **Delete**.
5. When the confirming message window appears, click **Yes**.
6. Click **OK** or **Print** until you exit the **Print** window.

Graphics tab options

Use the following Graphics options to adjust the print quality for your specific printing needs.

-  • The options you can select may vary depending on your printer model.
- If the option is grayed out or not shown, that option is not applicable with the printer language you are using.

To change the printer language:

1. Click the Windows **Start** menu.
2. For Windows 2000, select **Settings > Printers**.
-For Windows XP/Server 2003, select **Printer and Faxes**.
-For Windows Server 2008/Vista, select **Control Panel > Hardware and Sound > Printers**.
-For Windows 7, select **Control Panel > Hardware and**

Sound > Devices and Printers.

-For Windows Server 2008 R2, select **Control Panel > Hardware > Devices and Printers**.

3. Select the your machine's driver and right-click to open **Properties**.
4. In printer driver properties, select **Device Options**.
5. Select necessary options in the **Printer Language** drop-down list.

Adjusting color

If you feel the color difference between the printout and monitor, you may change the color setting such as color contrast or color level. The printer driver provides graphic options to adjust the print quality for specific printing needs.

1. To change the print settings from your software application, access **Printing Preferences** (See "Opening printing preferences" on page 60).
2. Click the **Graphics** tab. Refer to the online help for each option's information provided from the **Printing Preferences**.
 - **Color Mode:** You can choose color options between **Color** or **Grayscale**. Setting to **Color** typically produces the best possible print quality for color document. If you want to print a color document in gray scale, select **Grayscale**.

 **Black Optimization** allows you to print in high quality black. If you use this option, it might take longer to print.

To adjust color manually, select **Advanced** in **Color Mode**. Simply slide the color balance slider in the **Levels** tab to adjust color, or select **Matching** tab for driver provided color correction for general image processing.

- **Advanced:** You can set advanced settings by clicking the **Advanced** button. (PCL driver only)
 - **Font/ Text:** Select **Darken Text** to print text darker than on a normal document. Use **All Text Black** to prints solid black, regardless of the color it appears on the screen.
 - **Raster Compression:** This option determines the compression level of images for transferring data from computer to a printer. If you set this option to **Maximum**, the printing speed will be high, but the printing quality will be low. (PCL driver only)
 - **Graphic Controller:** It allows you to emphasize edges of texts and fine lines for improving readability and align each color channel registration in color printing mode.
 - **Grayscale Enhancement:** It allows users to preserve the details of nature photos, and improve contrast and readability among gray scaled colors, when printing color documents in grayscale. (PCL driver only)
 - **Fine Edge:** It allows you to emphasize edges of texts and fine lines for improving readability.
 - **Toner Save:** Adjusting this option extends the life of your toner cartridges and reduces your cost per page without a significant reduction in print quality.
 - You can move the slider from **No Saving** to **Maximum Saving** to reduce toner consumption.
3. Click **OK** or **Print** until you exit the **Print** window.

Adjusting the sharpness and smoothness



Screen options

This option affect the resolution and clarity of your color output. The three screen options are **Normal**, **Enhanced** and **Detailed**.

1. To change the print settings from your software application, access **Printing Preferences** (See "Opening printing preferences" on page 60).
2. Click the **Graphics** tab then select **Advanced** in **Color Mode**.
3. Select the **Matching** tab.
4. Select necessary options in the **Screen**.
 - **Printer default:** Follows the set value of **Screen** mode from the printer.
 - **Normal:** This mode will generate printouts with smooth tone over the entire page.
 - **Enhanced:** This mode will generate printouts with sharp texts and smooth graphic/photo objects in the page.
 - **Detailed:** This mode will generate printouts with sharp details over the entire page.
5. Select **OK**.

Changing the default print settings

 Most Windows applications will override settings you specify in the printer driver. Change all print settings available in the software application first, and change any remaining settings using the printer driver.

1. Click the Windows **Start** menu.
2. For Windows 2000, select **Settings > Printers**.
 - For Windows XP/Server 2003, select **Printers and Faxes**.
 - For Windows Server 2008/Vista, select **Control Panel > Hardware and Sound > Printers**.
 - For Windows 7, select **Control Panel > Devices and Printers**.
 - For Windows Server 2008 R2, select **Control Panel > Hardware > Devices and Printers**.
3. Right-click your machine.
4. For Windows XP/Server 2003/Server 2008/Vista, press **Printing Preferences**.
For Windows 7 or Windows Server 2008 R2, from context menus, select the **Printing preferences**.
 -  If **Printing preferences** item has a ► mark, you can select other printer drivers connected with the selected printer.
5. Change the settings on each tab.
6. Click **OK**.
 -  If you want to change the settings for each print job, change it in **Printing Preferences**.

Setting your machine as a default machine

1. Click the Windows **Start** menu.
2. For Windows 2000, select **Settings > Printers**.
 - For Windows XP/Server 2003, select **Printers and Faxes**.
 - For Windows Server 2008/Vista, select **Control Panel > Hardware and Sound > Printers**.
 - For Windows 7, select **Control Panel > Devices and Printers**.
 - For Windows Server 2008 R2, select **Control Panel > Hardware > Devices and Printers**.
3. Select your machine.
4. Right-click your machine and select **Set as Default Printer**.
 -  For Windows 7 or Windows Server 2008 R2, if **Set as default**

printer item has a ► mark, you can select other printer drivers connected with the selected printer.

Printing to a file (PRN)

You will sometimes need to save the print data as a file. You can print the document to a file instead of routing it directly to a printer. The document is saved with the printer formatting, such as font selection and color specifications, in a .prn file that can be printed on another printer.

To save a print job as a file:

1. Check the **Print to file** box at the **Print** window.

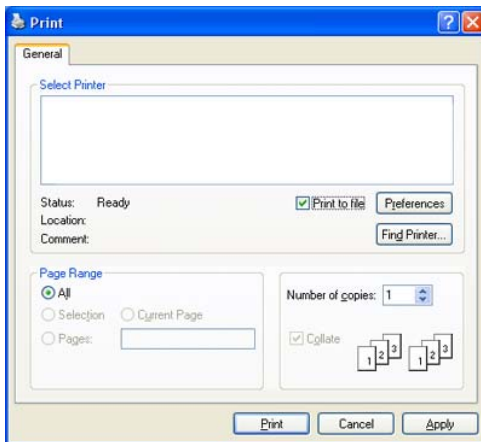

2. Click **Print**.
3. Type in the destination path and the file name, and then click **OK**.
For example c:\Temp\file name.

 If you type in only the file name, the file is automatically saved in **Documents and Settings** or **Users**. The saved folder may differ, depending on your operating system or the application you are using.

Macintosh printing

This section explains how to print using a Macintosh. You need to set the print environment before printing.

- USB connected, see "Macintosh" on page 31.
- Network connected, see "Macintosh" on page 38.

Printing a document

When you print with a Macintosh, you need to check the printer driver setting in each application you use. Follow the steps below to print from a Macintosh:

1. Open an application and select the file you want to print.
2. Open the **File** menu and click **Page Setup** (**Document Setup** in some applications).

3. Choose your paper size, orientation, scaling, other options, and make sure that your machine is selected. Click **OK**.

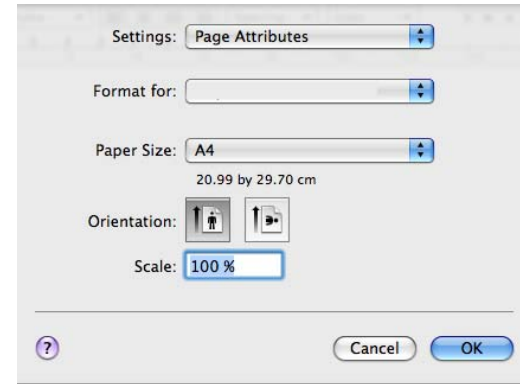

4. Open the **File** menu and click **Print**.
5. Choose the number of copies you want and indicate which pages you want to print.
6. Click **Print**.

Changing printer settings

You can use advanced printing features when using your machine.

Open an application and select **Print** from the **File** menu. The machine name, which appears in the printer properties window may differ depending on the machine in use. Except for the name, the composition of the printer properties window is similar to the following.

-  The setting options may differ depending on models and Macintosh OS versions.
- The following panes may differ, depending on your operating system or the application you are using.

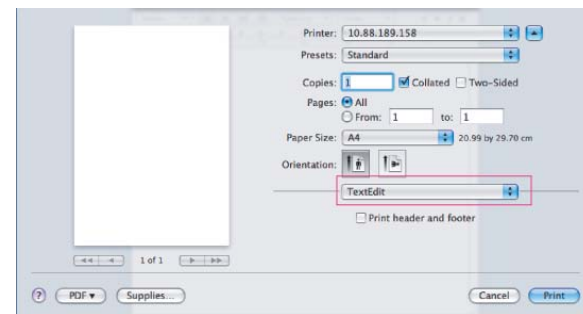

Layout

The **Layout** dialog provides options to adjust how the document appears on the printed page. You can print multiple pages on one sheet of paper. Select **Layout** from the drop-down list under **Orientation** to access the following features.

- **Pages per Sheet:** This option determines how many pages to be printed on one page (See "Printing multiple pages on one sheet of paper" on page 66).
- **Layout Direction:** This option allows you to select the printing direction on a page similar to the examples on UI.
- **Border:** This option allows you to print a border around each page on the sheet.
- **Reverse Page Orientation:** This option allows you to rotate paper 180 degrees.

Graphics

The **Graphics** dialog provides options for selecting **Quality** and **Color Mode**. Select **Graphics** from the drop-down list under **Orientation** to access the graphic features.

- **Quality:** This option allows you to select the printing resolution. The higher the setting, the sharper the clarity of printed characters and graphics. A higher setting will also increase the time it takes to print a document.
- **Color Mode:** You can set the color options. Setting to **Color** typically produces the best possible print quality for color documents. If you want to print a color document in grayscale, select **Grayscale**.

Printer Features

Set **Paper Type** to correspond to the paper loaded in the tray from which you want to print. This will let you get the best quality printout. If you load a different type of print material, select the corresponding paper type.

Printer Settings

Set **Toner Save** option to extend the life of your toner cartridge and reduces your cost per page without a significant reduction in print quality.

- **Printer Setting:** If you select this option, this feature is determined by the setting you've made from the machine.
- **On:** Select this option to allow the printer to use less toner on each page.
- **Off:** If you do not need to save toner when printing a document, select this option.

To access above feature:

1. Open the **Applications** folder > **Utilities** > **Print Setup Utility**.
 - For Mac OS X 10.5~10.6, open the **Applications** folder > **System Preferences** and click **Print & Fax**.
2. Select your printer, and click on **Show info** button.
 - For Mac OS X 10.5~10.6, select your printer and click on **Options & Supplies** button.
3. Click on **Installable Options** menu from the drop-down list in Printer info window.
 - For Mac OS X 10.5~10.6, move to **Driver** tab.

Printing multiple pages on one sheet of paper

You can print more than one page on a single sheet of paper. This feature provides a cost-effective way to print draft pages.

1. Open an application, and select **Print** from the **File** menu.
2. Select **Layout** from the drop-down list under **Orientation**. In the **Pages per Sheet** drop-down list, select the number of pages you want to print on one sheet of paper.

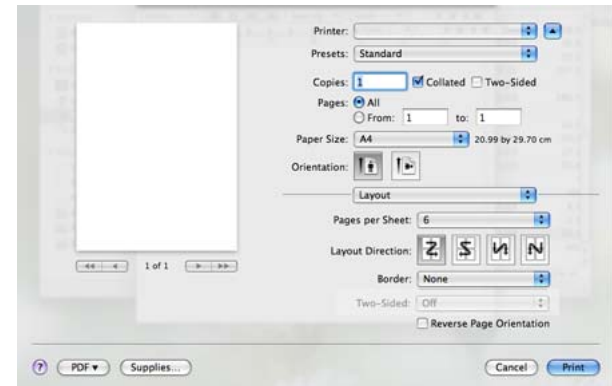

3. Select the other options you want to use.
4. Click **Print**, then the machine prints the selected the number of pages you want to print on one sheet of paper.

Linux printing

Some features may not be available depending on models or options. It means that the features are not supported.

Printing from applications

There are several Linux applications that allow you to print using the Common UNIX Printing System (CUPS). You can print using any of these applications.

1. Open an application, and select **Print** from the **File** menu.
2. Select **Print** directly using LPR.
3. From the LPR GUI window, select the model name of your machine from the printer list and click **Properties**.

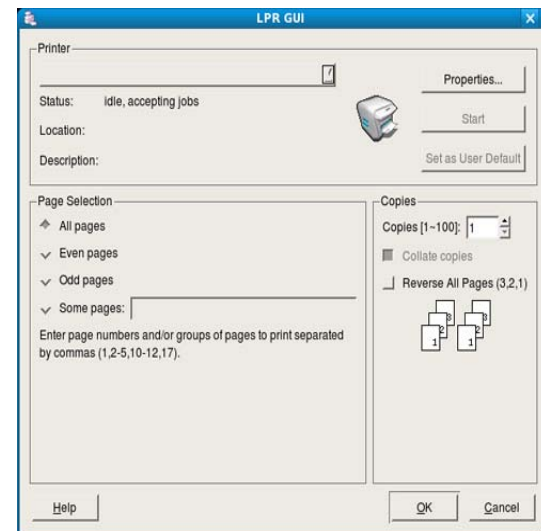

- Change the print job properties using the following four tabs displayed at the top of the window.

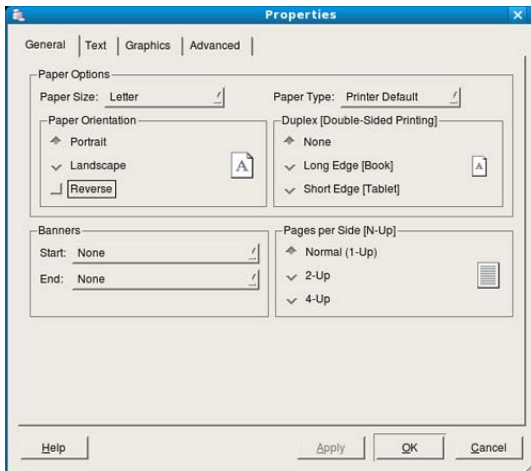

- General:** This option allows you to change the paper size, the paper type, and the orientation of the documents. It adds start and end banners, and changes the number of pages per sheet.
- Text:** This option allows you to specify the page margins and set the text options such as spacing or columns.
- Graphics:** This option allows you to set image options that are used when printing images/files such as color options, image size or image position.
- Advanced:** This option allows you to set the print resolution, paper source and special print features.

 If an option is grayed out, it means that the grayed out option is not supported by your machine.

 Automatic/manual duplex printing may not be available depending on models. You can alternatively use the lpr printing system or other applications for odd-even printing.

- Click **Apply** to apply the changes and close the **Properties** window.
- Click **OK** in the **LPR GUI** window to start printing.
- The Printing window appears, allowing you to monitor the status of your print job.
To abort the current job, click **Cancel**.

Printing files

You can print many different types of files on your machine using the standard CUPS way, directly from the command line interface. The CUPS LPR utility allows you to do that. But the drivers package replaces the standard LPR tool by a much more user-friendly LPR GUI program.

To print any document file:

- Type `lpr <file_name>` from the Linux shell command line and press Enter. The **LPR GUI** window appears.
When you type only `lpr` and press **Enter**, the **Select file(s) to print** window appears first. Just select any files you want to print and click **Open**.
- From the **LPR GUI** window, select your machine from the list, and change the print job properties.
- Click **OK** to start printing.

Configuring printer properties

Using the **Printer Properties** window provided by the **Printers configuration**, you can change the various properties for your printer.

- Open the **Unified Driver Configurator**.
If necessary, switch to **Printers configuration**.
- Select your machine from the available printers list and click **Properties**.
- The **Printer Properties** window opens.

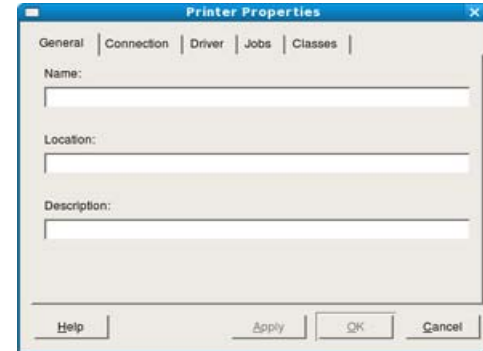

The following five tabs display at the top of the window:

- General:** This option allows you to change the printer location and name. The name entered in this tab displays on the printer list in **Printers configuration**.
 - Connection:** This option allows you to view or select another port. If you change the machine port from USB to parallel or vice versa while in use, you must re-configure the machine port in this tab.
 - Driver:** Allows you to view or select another printer driver. By clicking **Options**, you can set the default device options.
 - Jobs:** This option shows the list of print jobs. Click **Cancel job** to cancel the selected job and select the **Show completed jobs** check box to see previous jobs on the job list.
 - Classes:** This option shows the class that your machine is in. Click **Add to Class** to add your machine to a specific class or click **Remove from Class** to remove the machine from the selected class.
- Click **OK** to apply the changes and close the **Printer Properties** window.

management tools

This chapter introduces management tools provided to help you make full use of your machine.

This chapter includes:

- Introducing useful management tools
- Using SyncThru™ Web Service

Introducing useful management tools

The programs below help you to use your machine conveniently.

- "Using SyncThru™ Web Service" on page 68.
- "Using the Smart Panel program" on page 69.
- "Using the Unified Linux Driver Configurator" on page 70.

Using SyncThru™ Web Service

 Internet Explorer 6.0 or higher is the minimum requirement for SyncThru™ Web Service.

If you have connected your machine to a network and set up TCP/IP network parameters correctly, you can manage the machine via SyncThru™ Web Service, an embedded web server. Use SyncThru™ Web Service to:

- View the machine's device information and check its current status.
- Change TCP/IP parameters and set up other network parameters.
- Change printer preference.
- Set the email notifications advising of the machine's status.
- Get support for using the machine.

To access SyncThru™ Web Service

1. Access a web browser, such as Internet Explorer, from Windows.
Enter the machine IP address (<http://xxx.xxx.xxx.xxx>) in the address field and press the Enter key or click **Go**.
2. Your machine's embedded website opens.

Logging into SyncThru™ Web Service

Before configuring options in SyncThru™ Web Service, you need to log-in as an administrator. You can still use SyncThru™ Web Service without logging in but you won't have access to **Settings** tab and **Security** tab.

1. Click **Login** on the upper right of the SyncThru™ Web Service website.
A log-in page appears.
2. Type in the **ID** and **Password** then click **Login**.
If it's your first time logging into SyncThru™ Web Service, type in the below default ID and password.
 - **ID:** admin
 - **Password:** sec00000

SyncThru™ Web Service overview



 Some tabs may not appear depending on your model.

- Using the Smart Panel program
- Using the Unified Linux Driver Configurator

Information tab

This tab gives you general information about your machine. You can check things, such as remaining amount of toner. You can also print reports such as an error report and so on.

- **Active Alerts:** This item allows you to check the alerts occurred in the machine and their severity.
- **Supplies:** This item allows you to check how many pages are printed and amount of toner left in the cartridge.
- **Usage Counters:** This item allows you to check the usage count by print types: simplex, duplex.
- **Current Settings:** This item allows you to check the machine and network information.
- **Print information:** This item allows you to print reports such as system related reports, e-mail address and font reports.

Settings tab

This tab allows you to set configurations provided by your machine and network. You need to log-in as an administrator to view this tab.

- **Machine Settings tab:** This tab allows you to set options provided by your machine.
 - System:** You can set settings related to your machine.
 - Printer:** You can set settings related to printing jobs.
 - E-mail Notification:** You can set e-mail notification feature and e-mail address of recipients who will receive the notification.
- **Network Settings tab:** This tab allows you to view and change the network environment. You can set things, such as TCP/IP, network protocols and so on.
 - SNMP:** You can exchange of management information between network devices using SNMP.
 - Outgoing Mail Server(SMTP):** You can set the outgoing e-mail server.
 - Restore Default:** You can restore default network settings.

Security tab

This tab allows you to set system and network security information. You need to log-in as an administrator to view this tab.

- **System Security:** You can set the system administrator's information and also enable or disable machine features.
- **Network Security:** You can set settings for HTTPs, IPSec, IPv4/IPv6 filtering, 802.1x, Authentication servers.

Maintenance tab

This tab allows you to maintain your machine by upgrading firmware and setting contact information for sending emails. You can also connect to Samsung website or download drivers by selecting the **Link** menu.

- **Firmware Upgrade:** You can upgrade your machine's firmware.

- Contact Information:** You can view the contact information.
- Link:** You can view the links to useful sites where you can download or check information.

E-mail notification setup

You can receive emails about your machine's status by setting this option. By setting information such as IP address, host name, e-mail address and SMTP server information, the machine status (toner cartridge shortage or machine error) will be sent to a certain person's e-mail automatically. This option may be used more frequently by a machine administrator.

1. Start a web browser, such as Internet Explorer, from Windows.
Enter the machine IP address (http://xxx.xxx.xxx.xxx) in the address field and press the Enter key or click **Go**.
2. Your machine's embedded website opens.
3. Click **Login** on the upper right of the SyncThru™ Web Service website. A log-in page appears.
4. Type in the **ID** and **Password** then click **Login**.
If it's your first time logging into SyncThru™ Web Service, type in the below default ID and password.

•**ID:** admin

•**Password:** sec00000

5. From the **Settings** tab, select **Machine Settings > E-mail Notification**.

 If you haven't configured outgoing server environment, go to **Settings > Network Settings > Outgoing Mail Server(SMTP)** to configure network environment before setting e-mail notification.

6. Click **Add** button to add e-mail notification user.
Set the recipient name and e-mail address(es) with notification items you want to receive an alert for.
7. Click **Apply**.

 If the firewall is activated, the e-mail may not be sent successfully. In that case, contact the a network administrator.

Setting the system administrator information

Set the system administrator information. This setting is necessary for using the e-mail notification option.

1. Start a web browser, such as Internet Explorer, from Windows.
Enter the machine IP address (http://xxx.xxx.xxx.xxx) in the address field and press the Enter key or click **Go**.
2. Your machine's embedded website opens.
3. Click **Login** on the upper right of the SyncThru™ Web Service website. A log-in page appears.
4. Type in the **ID** and **Password** then click **Login**.
If it's your first time logging into SyncThru™ Web Service, type in the below default ID and password.

•**ID:** admin

•**Password:** sec00000

5. From the **Security** tab, select **System Security > System Administrator**
6. Enter the name of the administrator, phone number, location and E-mail address.
7. Click **Apply**.

Using the Smart Panel program

Smart Panel is a program that monitors and informs you of the machine status, and allows you to customize the machine's settings. For Windows and Macintosh, Smart Panel is installed automatically when you install the machine software. For Linux, you can download Smart Panel from the Samsung website (See "Installing the Smart Panel" on page 32).

 To use this program, your computer has to meet the following system requirements:



- Windows. Check that your computer's CPU, RAM and HDD meet or exceed specification (See "System requirements" on page 29).
- Mac OS X 10.3 or higher. Check that your computer's CPU, RAM and HDD meet or exceed specification (See "System requirements" on page 29).
- Linux. Check that your computer's CPU, RAM and HDD meet or exceed specification (See "System requirements" on page 29).
- Internet Explorer version 5.0 or higher for flash animation in HTML Help.

If you need to know the exact model number of your machine, you can check the supplied software CD.

Understanding Smart Panel

If an error occurs while printing, you can check the error from the Smart Panel.

You can also launch Smart Panel manually. Double-click the Smart Panel icon on the Windows task bar (in Windows), or Notification Area (in Linux).

Windows		Double-click this icon in Windows.
Linux		Click this icon in Linux.

Or, if you are a Windows user, you can launch it from the **Start** menu, select **Programs > All Programs > Samsung Printers > your printer driver name > Smart Panel**.

-  •If you have already installed more than one Samsung machine, first select the correct machine model you want in order to access the corresponding Smart Panel.
Right-click (in Windows or Linux) the Smart Panel icon and select your machine.
- The Smart Panel window and its contents shown in this user's guide may differ depending on the machine or operating system in use.

In case of Mac OS 10.3

1. Click **Print & Fax** in **System Preferences**.
2. Click **Set up Printers...**
3. Select printer in list and double click it.
4. Click **Utility**.

In case of Mac OS 10.4

1. Click **Print & Fax** in **System Preferences**.
2. Select printer in list and click **Printer Queue...**
3. Click **Utility**.

In case of Mac OS 10.5



1. Click **Print & Fax** in **System Preferences**.
2. Select printer in list and click **Open Printer Queue...**
3. Click **Utility**.

In case of Mac OS 10.6

1. Click **Print & Fax** in **System Preferences**.
2. Select printer in list and click **Open Printer Queue...**
3. Click **Printer Setup**.
4. Click **Utility** tab.
5. Click **Open Printer Utility**.

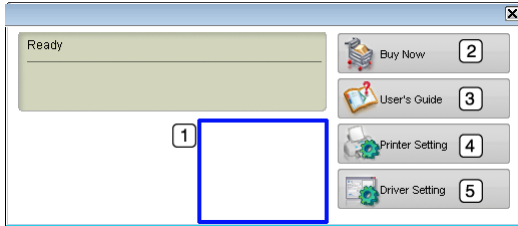
The Smart Panel program displays the current status of the machine, the estimated level of toner remaining in the toner cartridge(s), and various other types of information. You can also change settings.



1	Toner Level	View the level of toner remaining in the toner cartridge(s). The machine and the number of toner cartridge(s) shown in the above window may differ depending on the machine in use. Some machines do not have this feature.
2	Buy Now	Order replacement toner cartridge(s) online.
3	User's Guide	View the User's Guide.  This button changes to Troubleshooting Guide when error occurs. You can directly open the troubleshooting section in the user's guide.
4	Printer Setting	Configure various machine settings in the Printer Settings Utility window. Some machines do not have this feature.  If you connect your machine to a network, the SyncThru™ Web Service window appears instead of the Printer Settings Utility window.
5	Driver Setting	Set all of the machine options you need in the Printer Preferences window. This feature is available only for Windows (See "Opening printing preferences" on page 60).

Changing the Smart Panel Program Settings

Right-click (in Windows or Linux) the Smart Panel icon and select **Options**. Select the settings you want from the **Options** window.

Using the Unified Linux Driver Configurator

The Unified Driver Configurator is a tool primarily intended for configuring machine devices. You need to install Unified Linux Driver to use Unified Driver Configurator (See "Installing the Unified Linux Driver" on page 32).

After the driver is installed on your Linux system, the Unified Driver Configurator icon will automatically be created on your desktop.

Opening the Unified Driver Configurator

1. Double-click the **Unified Driver Configurator** on the desktop.
You can also click the **Startup** Menu icon and select **Samsung Unified**

Driver > Unified Driver Configurator.

2. Click each button on the left to switch to the corresponding configuration window.

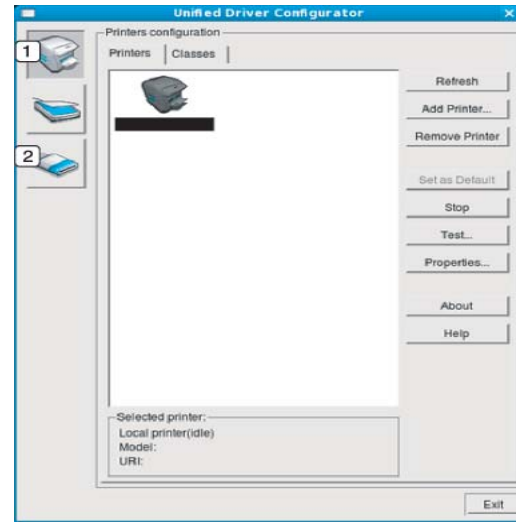

- 1 **Printers Configuration**
- 2 **Ports Configuration**

 To use the on screen help, click **Help**.

3. After changing the configurations, click **Exit** to close the Unified Driver Configurator.

Printers configuration window

Printers configuration has the two tabs: **Printers** and **Classes**.

Printers tab

View the current system's printer configuration by clicking on the machine icon button on the left side of the Unified Driver Configurator window.

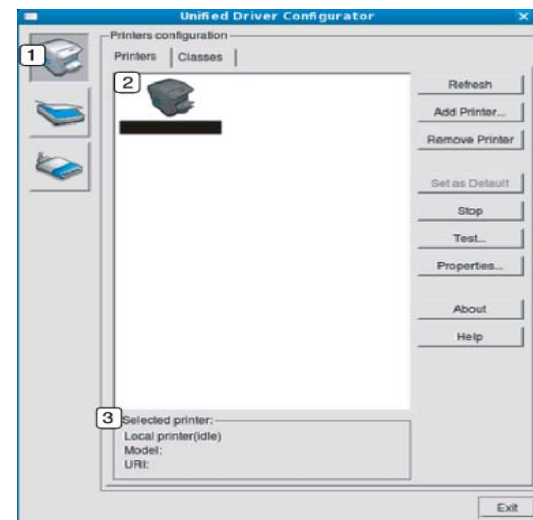

- 1 Switches to **Printers configuration**.
- 2 Shows all of the installed machine.
- 3 Shows the status, model name and URI of your machine.

The printer control buttons are, as follows:

- Refresh:** Renews the available machines list.
- Add Printer:** Allows you to add a new machines.
- Remove Printer:** Removes the selected machine.
- Set as Default:** Sets the current selected machine as a default machine.
- Stop/Start:** Stops/starts the machine.
- Test:** Allows you to print a test page to ensure the machine is working properly.
- Properties:** Allows you to view and change the printer properties.

Classes tab

The Classes tab shows a list of available machine classes.

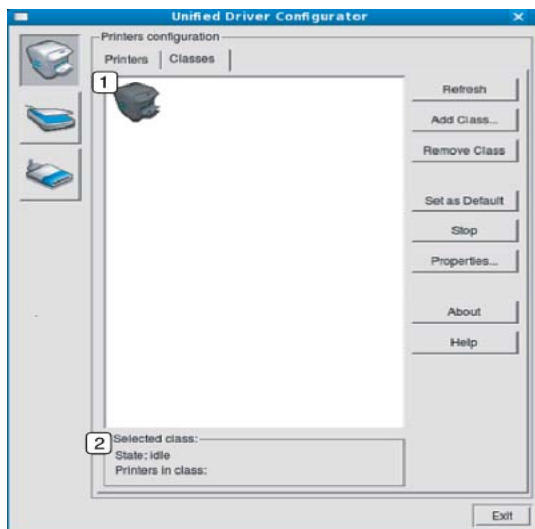

1 Shows all of the machine classes.

2 Shows the status of the class and the number of machines in the class.

- Refresh:** Renews the classes list.
- Add Class:** Allows you to add a new machine class.
- Remove Class:** Removes the selected machine class.

Ports configuration

In this window, you can view the list of available ports, check the status of each port, and release a port that is stalled in a busy state when its owner has terminated the job for any reason.

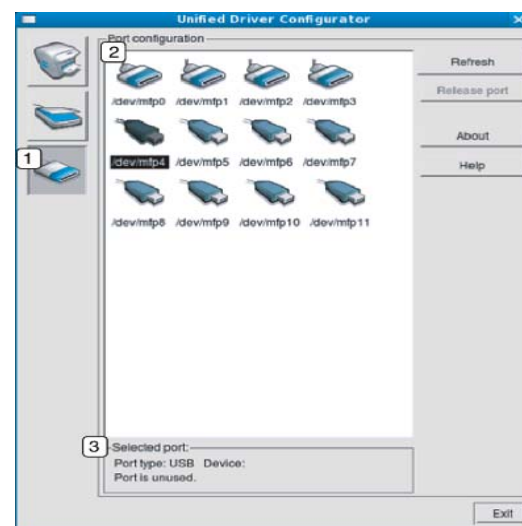

1 Switches to **Ports configuration**.

2 Shows all of the available ports.

3 Shows the port type, device connected to the port, and status.

- **Refresh:** Renews the available ports list.
- **Release port:** Releases the selected port.

maintenance

This chapter provides information about maintaining your machine and the toner cartridge.

This chapter includes:

- Printing a machine report
- Cleaning a machine

Printing a machine report

You can print a configuration page to view current printer settings, or to help troubleshoot printer problems.

In ready mode, press and hold the **Cancel** (Ⓢ) button for about 5 seconds, then release.

A configuration page prints out.

Cleaning a machine

If printing quality problems occur or if you use your machine in a dusty environment, you need to clean your machine regularly to keep the most optimum printing quality.



- Cleaning the cabinet of the machine with cleaning materials containing large amounts of alcohol, solvent, or other strong substances can discolor or distort the cabinet.
- If your machine or the surrounding area is contaminated with toner, we recommend that you use a cloth or tissue dampened with water to clean it. If you use a vacuum cleaner, toner blows in the air and might be harmful if inhaled.

Cleaning the outside

Clean the machine cabinet with a soft, lint-free cloth. Dampen the cloth slightly with water, but be careful not to let any water drip onto or into the machine.

Cleaning the inside

During the printing process, paper, toner and dust particles can accumulate inside the machine. This buildup can cause print quality problems such as toner specks or smearing. Cleaning the inside of the machine clears or reduces these problems.

1. Turn the machine off and unplug the power cord. Wait for the machine to cool down.
2. Press the release button, completely open the front cover.

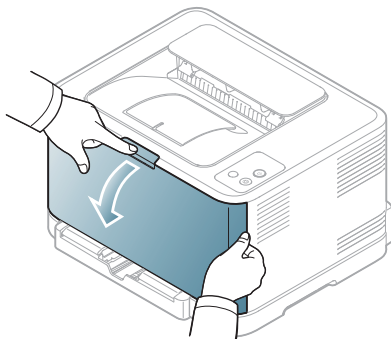

- Storing the toner cartridge
- Tips for moving & storing your machine

3. Grasp the handles on the toner cartridge and pull to remove the cartridge from the machine.

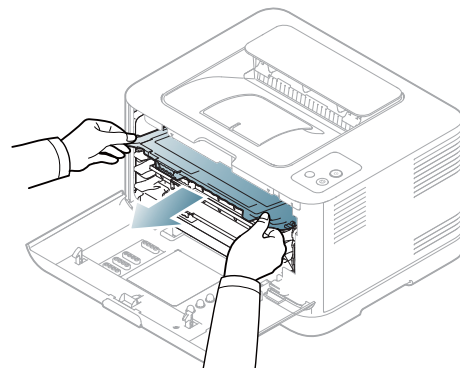

4. Pull the waste toner container out of the machine using its handle.

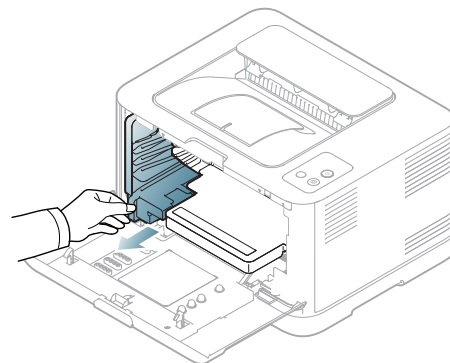

5. Pull the imaging unit out of the machine using the groove on the front of the imaging unit.

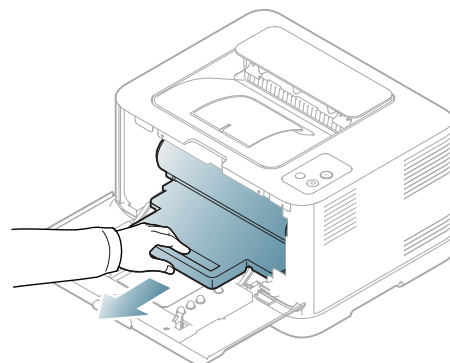

- Do not touch the green surface of the drum located in the imaging unit. Use the handle on the imaging unit to avoid touching this

area.

- Be careful not to scratch the surface of the imaging unit.
 - If you leave the front cover open for more than a few minutes, the imaging unit can be exposed to light. This will cause damage to the imaging unit. Close the front cover should the installation need to be halted for any reason.
6. With a dry lint-free cloth, wipe away any dust and spilled toner from the toner cartridges area and their cavities.

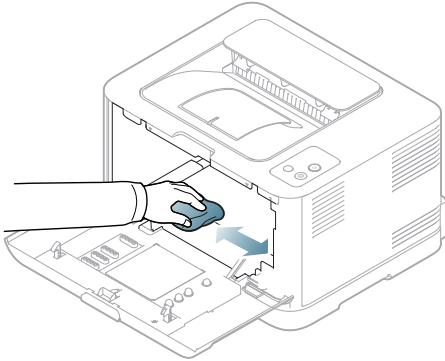

After cleaning, let the machine to dry completely.



- If toner gets on your clothing, wipe it off with a dry cloth and wash it in cold water. Hot water sets toner into fabric.
 - If your machine or its surrounding is contaminated with toner, we recommend you to use a cloth or tissue dampened with water to clean it. If you use a vacuum cleaner, toner blows into the air then might be harmful to you.
7. Holding the groove on the front of the imaging unit, push imaging unit into the machine.

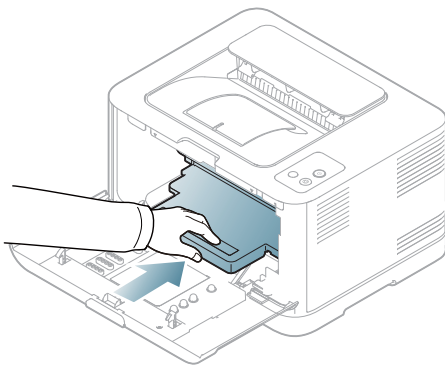

8. Insert the waste toner container into position and then push it to make sure that it is firmly seated in place.

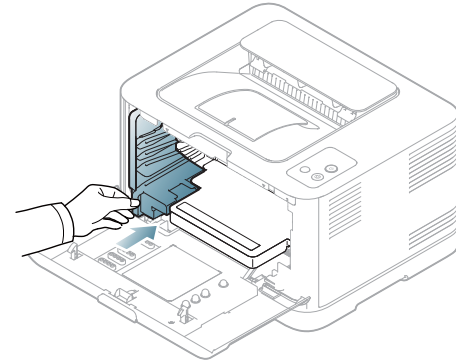

9. Slide the toner cartridge back into the machine.

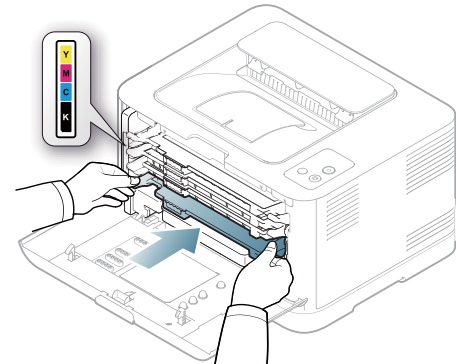

10. Reinstall all the compartments into the machine and close the front cover.



If the front cover is not completely closed, the machine will not operate.

11. Plug in the power cord and turn the machine on.

Storing the toner cartridge

Toner cartridge storage

Toner cartridges contain components that are sensitive to light, temperature, and humidity. Samsung suggests users follow the recommendations to ensure the optimum performance, highest quality, and longest life from your new Samsung toner cartridge.

Store this cartridge in the same environment as the printer it will be used in; this should be in controlled office temperature and humidity conditions. The toner cartridge should remain in its original, unopened package until installation – If original packaging is not available, cover the top opening of the cartridge with paper and store in a dark cabinet.

Opening the cartridge package prior to use dramatically shortens its useful shelf and operating life. Do not store on the floor. If the toner cartridge is removed from the printer, always store the cartridge according to the following guidelines:

- Inside the protective bag from the original package.
- Store lying flat (not standing on end) with the same side facing up as if was installed in the machine.
- Do not store consumable in any of the following conditions:
 - Temperature greater than 40°C (104°F).
 - Humidity range less than 20% and not greater than 80%.

- An environment with extreme changes in humidity or temperature.
- Direct sunlight or room light.
- Dusty places.
- A car for a long period of time.
- An environment where corrosive gases are present.
- An environment with salty air.

Handling instructions

- Do not touch the surface of the photoconductive drum in the cartridge.
- Do not expose the cartridge to unnecessary vibrations or shock.
- Never manually rotate the drum, especially in the reverse direction; this can cause internal damage and toner spillage.

Use of non-Samsung and refilled toner cartridge

Samsung Electronics does not recommend or approve the use of non-Samsung brand toner cartridges in your printer including generic, store brand, refilled, or remanufactured toner cartridges.



Samsung's printer warranty does not cover damage to the machine caused by the use of a refilled, remanufactured, or non-Samsung brand toner cartridge.

Estimated cartridge life

Estimated cartridge life (the life of the toner cartridge yield) depends on the amount of toner that print jobs require. The actual print yield may vary depending on the print density of the pages you print on, operating environment, printing interval, media type, and/or media size. For example, if you print a lot of graphics, the consumption of the toner is high and you may need to change the cartridge more often.

Tips for moving & storing your machine

- When moving the machine, do not tilt or turn it upside down. Otherwise, the inside of the machine may be contaminated by toner, which can cause damage to the machine or reduce print quality.
- When moving the machine, make sure at least two people are holding the machine securely.

troubleshooting

This chapter gives helpful information for what to do if you encounter an error.

This chapter includes:

- Redistributing toner
- Tips for avoiding paper jams

Redistributing toner

It is possible that colored images may be printed with incorrect colors due to flawed mixing of toner colors when one of the colored toner cartridges is low on toner. You can temporarily improve print quality by redistributing the toner.

 The Smart Panel program window appears on the computer telling you which cartridge is low on toner (See "Using the Smart Panel program" on page 69).

1. Press the release button, completely open the front cover.

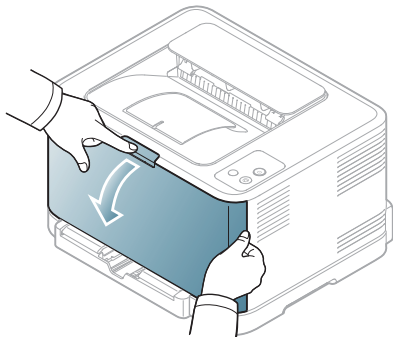

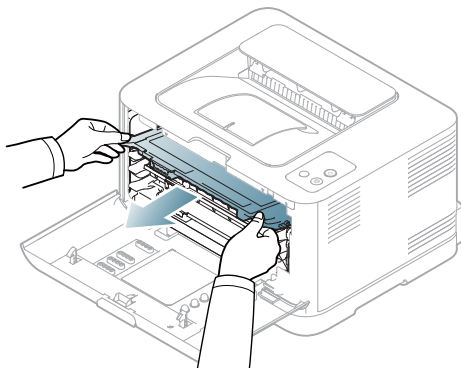

2. Grasp the handle on the toner cartridge and pull to remove the cartridge from the machine.

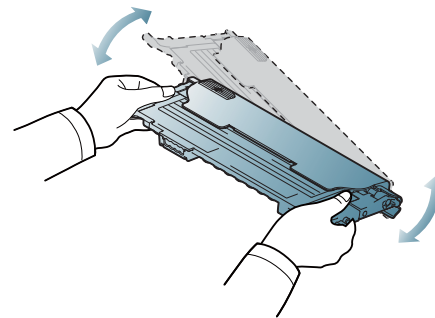

- Clearing paper jams
- Solving other problems

3. Holding both handles on the toner cartridge, thoroughly rock it from side to side to evenly distribute the toner.



 If toner gets on your clothing, wipe it off with a dry cloth and wash it in cold water. Hot water sets toner into fabric.

4. Slide the toner cartridge back into the machine.

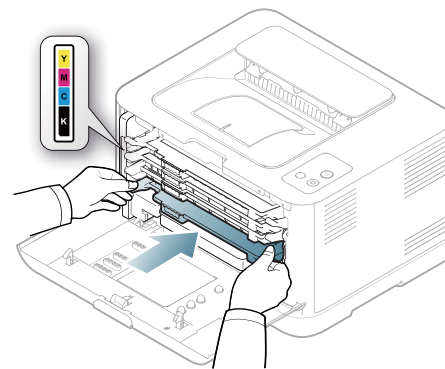

5. Close the front cover. Make sure the cover is securely latched.

 If the front cover is not completely closed, the machine will not operate.

Tips for avoiding paper jams

By selecting the correct media types, most paper jams can be avoided. When a paper jam occurs, refer to the guidelines below (See "Clearing paper jams" on page 76).

- Follow the procedures on "Changing the tray size" on page 53. Ensure that the adjustable guides are positioned correctly.
- Do not overload the tray. Ensure that the paper level is below the paper capacity mark on the inside of the tray.
- Do not remove paper from the tray while your machine is printing.
- Flex, fan, and straighten paper before loading.
- Do not use creased, damp, or highly curled paper.

- Do not mix paper types in a tray.
- Use only recommended print media ("Setting the paper size and type" on page 58).
- Ensure that the recommended side of the print media is facing up in the tray.

Clearing paper jams

 To avoid tearing the paper, pull the jammed paper out slowly and carefully. Follow the instructions in the following sections to clear the jam.

If a paper jam occurs, the status LED on the control panel lights orange. Find and remove the jammed paper.

If paper is jammed in the paper feed area, follow the next steps to release the jammed paper.

In the tray

 Click this link to open an animation about clearing a jam.

1. Open and close the front cover. The jammed paper is automatically ejected from the machine. If the paper does not eject, go to the next step.
2. Pull out the tray.

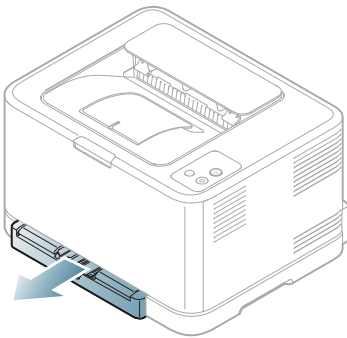

3. Remove the jammed paper by gently pulling it straight out.

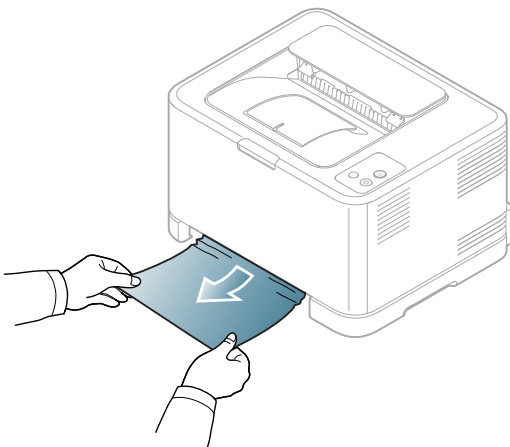

If the paper does not eject when you pull, or if you do not see the paper in this area, check the fuser area around the toner cartridge (See "Inside the machine" on page 76).

4. Insert the tray back into the machine until it snaps into place. Printing automatically resumes.

Inside the machine

 Click this link to open an animation about clearing a jam.

 The fuser area is hot. Be careful when removing paper from this area to prevent getting your fingers burnt.

1. Open and close the front cover. The jammed paper is automatically ejected from the machine. If the paper does not eject, go to the next step.
2. To remove the jammed paper, open the rear cover.

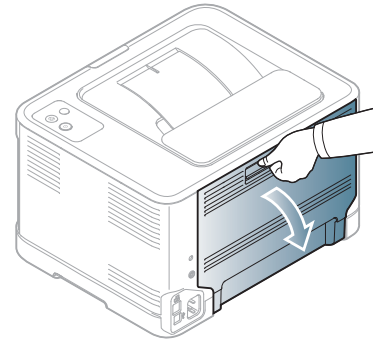

3. Carefully remove the jammed paper by pulling in the direction as shown below. Most of the jammed paper can be removed in this step.

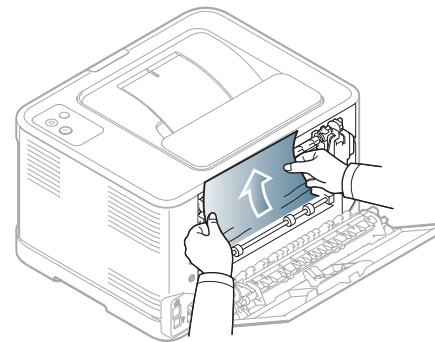



 Do not touch the fuser inside the inner cover. It is hot and could cause burns. Be careful when removing paper from this area to prevent getting your fingers burnt.

If the paper does not eject when you pull, or if you do not see the paper in this area, check the paper exit area (See "In the paper exit area" on page 76).

4. Close the rear cover. Make sure that it is securely closed. Printing automatically resumes.

In the paper exit area

 Click this link to open an animation about clearing a jam.

 The fuser area is hot. Be careful when removing paper from this area to prevent getting your fingers burnt.

1. Gently pull the paper out the output tray.

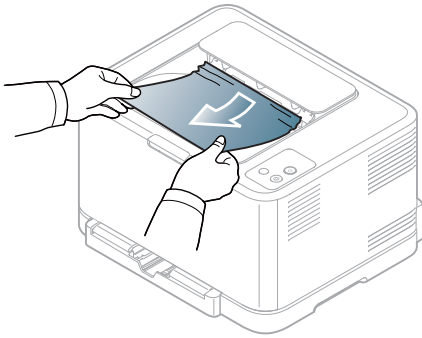

If you do not see the jammed paper or if there is any resistance when you pull, stop and go to the next step.

2. To remove the jammed paper, open the rear cover.

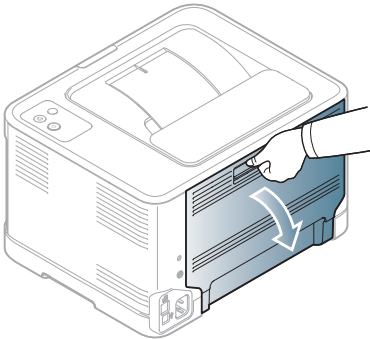

3. Carefully remove the paper by pulling in the direction as shown below. Most of the jammed paper can be removed in this step.

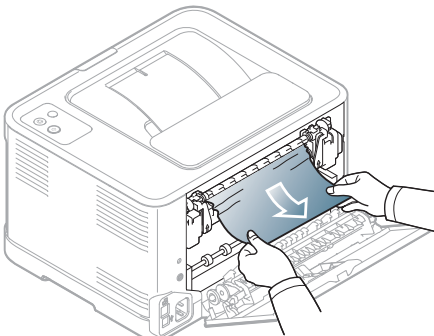

If you cannot find the jammed paper, or if there is any resistance removing the paper, go to the next step.

-  If the paper tears, make sure that all of the paper fragments are removed from the machine.

4. Push the fuser levers upwards.

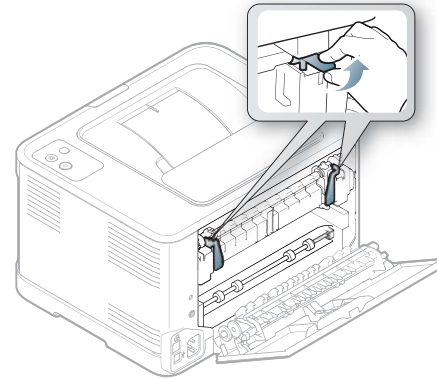

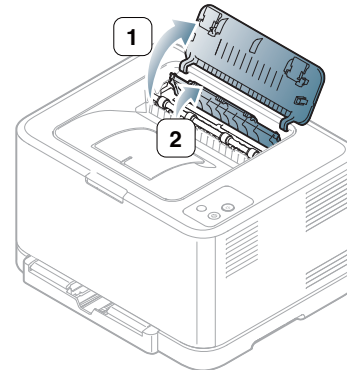

-  The fuser area is hot. Take care when removing paper from the machine.

5. Open the top cover and inner cover.

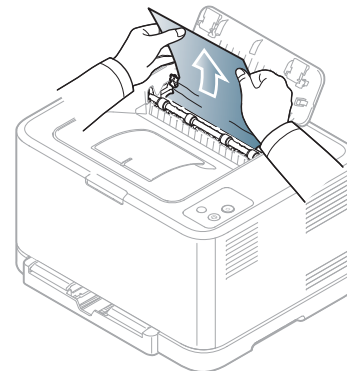

6. Holding the inner cover open, carefully take the jammed paper out the machine. The inner cover will then close automatically.



-  Do not touch the fuser inside the inner cover. It is hot and could cause burns. Be careful when removing paper from this area to prevent getting your fingers burnt.

7. Close the top cover. Make sure that it is securely closed.

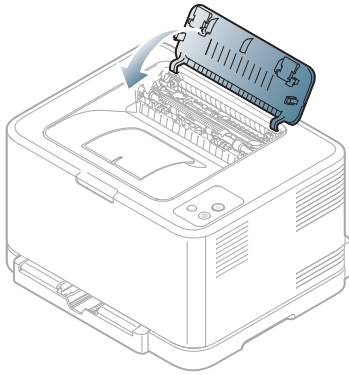

8. Push the fuser levers downwards.

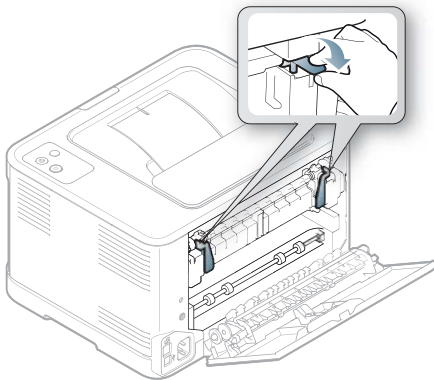

9. Open and then close the rear cover or front cover to resume printing.

Solving other problems

The following chart lists some trouble conditions that may occur and the recommended solutions. Follow the suggested solutions until the problem is corrected. If the problem persists, contact a service representative.

Other problems include:

- See "System problems" on page 78.
- See "Power problems" on page 78.
- See "Paper feeding problems" on page 79.
- See "Printing problems" on page 80.
- See "Printing quality problems" on page 81.
- See "Common Windows problems" on page 84.
- See "Common Linux problems" on page 84.
- See "Common Macintosh problems" on page 85.

System problems

Condition	Suggested solutions
The red error light is on.	Turn the machine on/off. If the problem persists, contact a service representative (See "Contact SAMSUNG worldwide" on page 94").  The machine is experiencing problems that require service such as LSU error or fuser error.

Power problems

-  [Click this link to open an animation about power problems.](#)

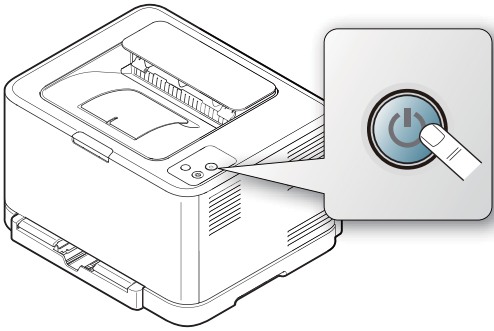
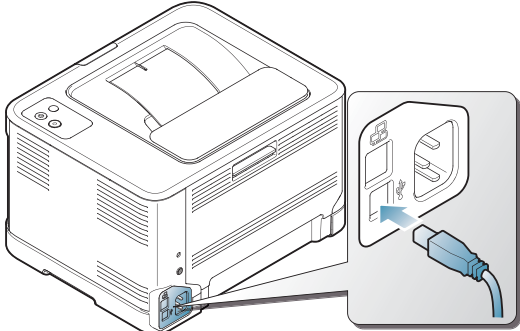
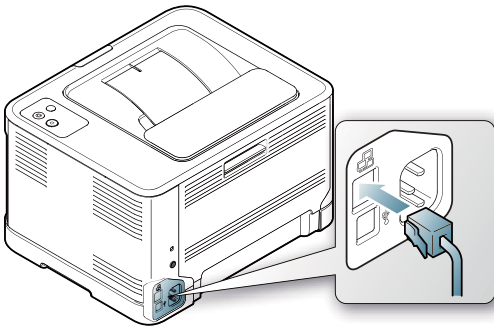
Condition	Suggested solutions
<p>The machine is not receiving power, or the connection cable between the computer and the machine is not connected properly.</p>	<ul style="list-style-type: none"> Plug in the power cord and press Power (⏻) button on the control panel. 
	<ul style="list-style-type: none"> Disconnect the machine cable and reconnect it. <ul style="list-style-type: none"> -For Local Printing 
	<ul style="list-style-type: none"> - For Network (CLP-320N(K)/CLP-321N/CLP-325W(K)/CLP-326W only) 

Condition	Suggested solutions
<p>Paper sticks together.</p>	<ul style="list-style-type: none"> Check the maximum paper capacity of the tray (See "Print media specifications" on page 92). Make sure that you are using the correct type of paper (See "Print media specifications" on page 92). Remove paper from the tray and flex or fan the paper. Humid conditions may cause some paper to stick together, replace with a new stack.
<p>Multiple sheets of paper do not feed.</p>	<p>Different types of paper may be stacked in the tray. Load paper of only one type, size and weight.</p>
<p>Paper does not feed into the machine.</p>	<ul style="list-style-type: none"> Remove any obstructions from inside the machine. Paper has not been loaded correctly. Remove paper from the tray and reload it correctly. There is too much paper in the tray. Remove excess paper from the tray. The paper is too thick. Use only paper that meets the specifications required by the machine (See "Print media specifications" on page 92).
<p>The paper keeps jamming.</p>	<ul style="list-style-type: none"> There is too much paper in the tray. Remove excess paper from the tray. An incorrect type of paper is being used. Use only paper that meets the specifications required by the machine (See "Print media specifications" on page 92). There may be debris inside the machine. Open the front cover and remove any debris.
<p>Transparencies stick together in the paper exit.</p>	<p>Use only transparencies specifically designed for laser printers. Remove each transparency as it exits from the machine.</p>
<p>Envelopes skew or fail to feed correctly.</p>	<p>Ensure that the paper guides are against both sides of the envelopes.</p>

Paper feeding problems

Condition	Suggested solutions
<p>Paper jams during printing.</p>	<p>Clear the paper jam (See "Clearing paper jams" on page 76).</p>

Printing problems

Condition	Possible cause	Suggested solutions
The machine does not print.	The machine is not receiving power.	Check the power cord connections.
	The machine is not selected as the default machine.	Select your machine as your default machine in your Windows.
	Check the machine for the following: <ul style="list-style-type: none"> The front cover is not closed. Close the front cover. Paper is jammed. Clear the paper jam (See "Clearing paper jams" on page 76). No paper is loaded. Load paper (See "Loading paper in the tray" on page 54). The toner cartridge is not installed. Install the toner cartridge. If a system error occurs, contact a service representative.	
	The connection cable between the computer and the machine is not connected properly.	Disconnect the machine cable and reconnect it.
	The connection cable between the computer and the machine is defective.	If possible, attach the cable to another computer that is working properly and print a job. You can also try using a different machine cable.
	The port setting is incorrect.	Check the Windows printer setting to make sure that the print job is sent to the correct port. If the computer has more than one port, make sure that the machine is attached to the correct one.
	The machine may be configured incorrectly.	Check the Printing Preferences to ensure that all of the print settings are correct (See "Opening printing preferences" on page 60).
	The printer driver may be incorrectly installed.	Repair the machine software (See "Installing USB connected machine's driver" on page 30, "Installing network connected machine's driver" on page 37).
The machine is malfunctioning.	<ul style="list-style-type: none"> Check the LEDs on the control panel to see if the machine is indicating a system error. If the error cannot be cleared, contact a service representative. Checking an error message is also possible from the Smart Panel on your computer (See "Using the Smart Panel program" on page 69). 	

Condition	Possible cause	Suggested solutions
	The document size is so big that the hard disk space of the computer is insufficient to access the print job.	Allocate more hard disk space on your computer for spooling, and try printing.
	The output tray is full.	It can hold up to 80 (80 g/m ²) sheets of plain paper. Once the paper is removed from the output tray, the machine resumes printing.
	If the machine is used for a long time continuously, the printing speed could be slowed down, or the machine could pause to cool down.	Wait for the machine to cool down. Printing automatically resumes after the machine is cooled down.
The machine selects print materials from the wrong paper source.	The paper option that was selected in the Printing Preferences may be incorrect.	For many software applications, the paper source selection is found under the Paper tab within the Printing Preferences . Select the correct paper source. (See "Opening printing preferences" on page 60).
A print job is extremely slow.	The job may be very complex.	Reduce the complexity of the page or try adjusting the print quality settings.
Half the page is blank.	The page orientation setting may be incorrect.	Change the page orientation in your application. See the printer driver help screen.
	The paper size and the paper size settings do not match.	Ensure that the paper size in the printer driver settings matches the paper in the tray. Or, ensure that the paper size in the printer driver settings matches the paper selection in the software application settings you use.

Condition	Possible cause	Suggested solutions
The machine prints, but the text is wrong, garbled, or incomplete.	The machine cable is loose or defective.	Disconnect the machine cable and reconnect. Try a print job that you have already printed successfully. If possible, attach the cable and the machine to another computer that you know works and try a print job. Finally, try a new machine cable.
	The wrong printer driver was selected.	Check the application's printer selection menu to ensure that your machine is selected.
	The software application is malfunctioning.	Try printing a job from another application.
	The operating system is malfunctioning.	Exit Windows and reboot the computer. Turn the machine off and back on again.
	If you are in a DOS environment, the font setting for your machine may be set incorrectly.	See "Changing font setting (CLP-320N(K)/CLP-321N/CLP-325W(K) /CLP-326W only)" on page 51.
Pages print, but they are blank.	The toner cartridge is defective or out of toner.	Redistribute the toner, if necessary. If necessary, replace the toner cartridge.
	The file may have blank pages.	Check the file to ensure that it does not contain blank pages.
	Some parts, such as the controller or the board, may be defective.	Contact a service representative.
The machine does not print PDF file correctly. Some graphics, text, or illustrations are missing.	Incompatibility between the PDF file and the Acrobat products.	Printing the PDF file as an image may enable the file to print. Turn on Print As Image from the Acrobat printing options.  It will take longer to print when you print a PDF file as an image.

Condition	Possible cause	Suggested solutions
The print quality of photos is not good. Images are not clear.	The resolution of the photo is very low.	Reduce the photo size. If you increase the photo size in the software application, the resolution will be reduced.
Before printing, the machine emits vapor near the output tray.	Using damp paper can cause vapor during printing.	This is not a problem. Just keep printing.
The machine does not print special-sized paper, such as billing paper.	The Paper size and paper size setting do not match.	Set the correct paper size in the Edit... in the Paper tab in the Printing Preferences (See "Opening printing preferences" on page 60).
The printed billing paper is curled.	The paper type setting does not match.	Change the printer option and try again. Go to Printing Preferences , click Paper tab, and set type to Thick (See "Opening printing preferences" on page 60).
The printed paper is curled.	Paper curl occurs due to many different factors such as temperature humidity, paper type, high coverage printing, etc.	Use the Paper Curl Reduction option. Go to Printing Preferences (See "Opening printing preferences" on page 60), click Advanced tab, and click the Paper Curl Reduction check box. This option will optimize environmental factors to reduce the paper curl level.

Printing quality problems

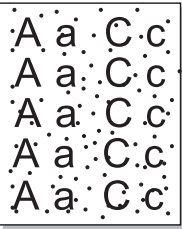
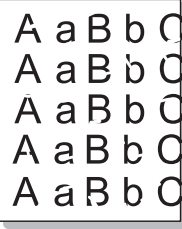
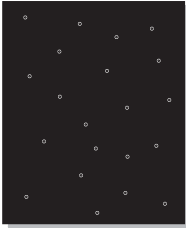

If the inside of the machine is dirty or paper has been loaded improperly, you may notice a reduction in print quality. See the table below to clear the problem.

Condition	Suggested solutions
Light or faded print 	<ul style="list-style-type: none"> If a vertical white streak or faded area appears on the page, the toner supply is low. You may be able to temporarily extend the toner cartridge life (See "Redistributing toner" on page 75). If this does not improve the print quality, install a new toner cartridge. The paper may not meet paper specification; for example, the paper is too moist or too rough (See "Print media specifications" on page 92). If the entire page is light, the print resolution setting is too low. Adjust the print resolution. See the help screen of the printer driver. A combination of faded or smeared defects may indicate that the toner cartridge needs cleaning (See "Cleaning the inside" on page 72). The surface of the LSU part inside the machine may be dirty. Clean the LSU by opening and closing the front cover several times and if the problem still occurs call the contact a service representative.

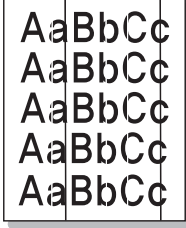
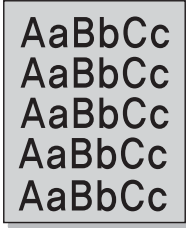
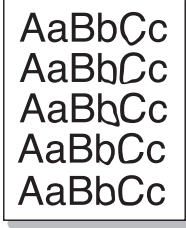
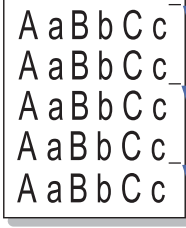
Condition	Suggested solutions
<p>The top half of the paper is printed lighter than the rest of the paper</p> 	<p>The toner might not adhere properly to this type of paper.</p> <ul style="list-style-type: none"> Change the printer option and try again. Go to the Printing Preferences, click the Paper tab, and set the paper type to Recycled.
<p>Toner specks</p> 	<ul style="list-style-type: none"> The paper may not meet specification; for example, the paper is too moist or too rough (See "Print media specifications" on page 92). The paper path may need cleaning (See "Cleaning the inside" on page 72).
<p>Dropouts</p> 	<p>If faded areas, generally rounded, occur randomly on the page.</p> <ul style="list-style-type: none"> A single sheet of paper may be defective. Try reprinting the job. The moisture content of the paper is uneven or the paper has moist spots on its surface. Try a different brand of paper (See "Print media specifications" on page 92). The paper lot is bad. The manufacturing processes can cause some areas to reject toner. Try a different kind or brand of paper. Change the printer option and try again. Go to printer properties, click the Paper tab and set type to Thick Paper (See "Opening printing preferences" on page 60). If these steps do not correct the problem, contact a service representative.
<p>White Spots</p> 	<p>White spots appear on the page.</p> <ul style="list-style-type: none"> The paper is too rough and a lot of dirt from the paper falls to the inner devices within the machine, which means the transfer belt may be dirty. Clean the inside of your machine. Contact a service representative. The paper path may need cleaning. Contact a service representative.

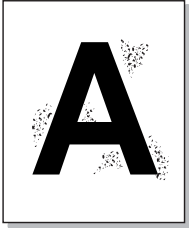
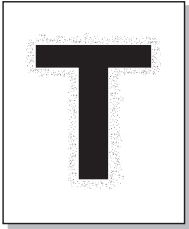
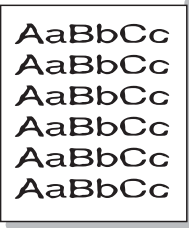
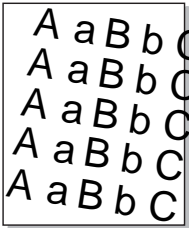
Condition	Suggested solutions
<p>Vertical lines</p> 	<p>If black vertical streaks appear on the page:</p> <ul style="list-style-type: none"> The imaging unit has probably been scratched. Remove the imaging unit and install a new one (See "Replacing the imaging unit" on page 87). <p>If white vertical streaks appear on the page:</p> <ul style="list-style-type: none"> The surface of the LSU part inside the machine may be dirty. Clean the LSU by opening and closing the front cover several times and if the problem still occurs call the contact a service representative.
<p>Color or Black background</p> 	<p>If the amount of background shading becomes unacceptable:</p> <ul style="list-style-type: none"> Change to a lighter weight paper (See "Print media specifications" on page 92). Check the machine's environment: very dry (low humidity) or high humidity (higher than 80% RH) conditions can increase the amount of background shading. Remove the old toner cartridge and install a new one (See "Replacing the toner cartridge" on page 86).
<p>Toner smear</p> 	<ul style="list-style-type: none"> Clean the inside of the machine. See "Cleaning the inside" on page 72. Check the paper type and quality. See "Print media specifications" on page 92. Remove the toner cartridge and install a new one. See "Replacing the toner cartridge" on page 86.
<p>Vertical repetitive defects</p> 	<p>If marks repeatedly appear on the printed side of the page at even intervals:</p> <ul style="list-style-type: none"> The toner cartridge may be damaged. If a repetitive mark occurs on the page, print a cleaning sheet several times to clean the cartridge. After the printout, if you still have the same problems, remove the toner cartridge and install a new one (See "Replacing the toner cartridge" on page 86). Parts of the machine may have toner on them. If the defects occur on the back of the page, the problem will likely correct itself after a few more pages. The fusing assembly may be damaged. Contact a service representative.

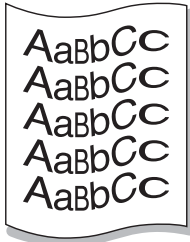
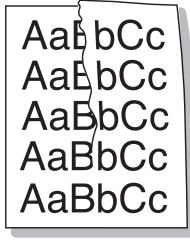
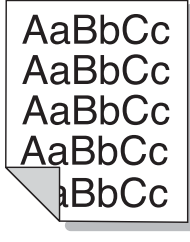
Condition	Suggested solutions
Background scatter 	<p>Background scatter results from bits of toner randomly distributed on the printed page.</p> <ul style="list-style-type: none"> The paper may be too damp. Try printing with a fresh ream of paper. Do not open packages of paper until necessary so that the paper does not absorb too much moisture. If background scatter occurs on an envelope, change the printing layout to avoid printing over areas that have overlapping seams on the reverse side. Printing on seams can cause problems. If background scatter covers the entire surface area of a printed page, adjust the print resolution through your software application or the printer properties.
Toner particles are around bold characters or pictures 	<p>The toner might not adhere properly to this type of paper.</p> <ul style="list-style-type: none"> Change the printer option and try again. Go to the Printing Preferences, click the Paper tab, and set the paper type to Recycled.
Misformed characters 	<ul style="list-style-type: none"> If characters are improperly formed and producing hollow images, the paper stock may be too slick. Try a different paper (See "Print media specifications" on page 92).
Page skew 	<ul style="list-style-type: none"> Ensure that the paper is loaded properly. Check the paper type and quality (See "Print media specifications" on page 92). Ensure that the paper or other material is loaded correctly and the guides are not too tight or too loose against the paper stack.

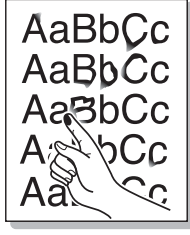
Condition	Suggested solutions
Curl or wave 	<ul style="list-style-type: none"> Ensure that the paper is loaded properly. Check the paper type and quality. Both high temperature and humidity can cause paper curl (See "Print media specifications" on page 92). Turn over the stack of paper in the tray. Also try rotating the paper 180° in the tray.
Wrinkles or creases 	<ul style="list-style-type: none"> Ensure that the paper is loaded properly. Check the paper type and quality (See "Print media specifications" on page 92). Turn over the stack of paper in the tray. Also try rotating the paper 180° in the tray.
Back of printouts are dirty 	<ul style="list-style-type: none"> Check for leaking toner. Clean the inside of the machine (See "Cleaning the inside" on page 72).
Solid Color or Black pages 	<ul style="list-style-type: none"> The toner cartridge may not be installed properly. Remove the cartridge and reinsert it. The toner cartridge may be defective and need replacing. Remove the toner cartridge and install a new one (See "Replacing the toner cartridge" on page 86). The machine may require repair. Contact a service representative.
Loose toner 	<ul style="list-style-type: none"> Clean the inside of the machine (See "Cleaning the inside" on page 72). Check the paper type and quality (See "Print media specifications" on page 92). Remove the toner cartridge and install a new one (See "Replacing the toner cartridge" on page 86). If the problem persists, the machine may require repair. Contact a service representative.

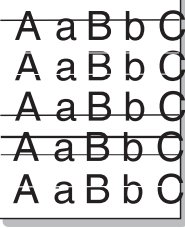
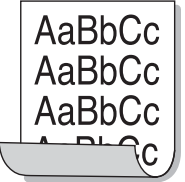
Condition	Suggested solutions
<p>Character Voids</p> 	<p>Character voids are white areas within parts of characters that should be solid black:</p> <ul style="list-style-type: none"> If you are using transparencies, try another type of transparency. Because of the composition of transparencies, some character voids are normal. You may be printing on the wrong surface of the paper. Remove the paper and turn it over. The paper may not meet paper specifications (See "Print media specifications" on page 92).
<p>Horizontal stripes</p> 	<p>If horizontally aligned black streaks or smears appear:</p> <ul style="list-style-type: none"> The toner cartridge may be installed improperly. Remove the cartridge and reinsert it. The toner cartridge may be defective. Remove the toner cartridge and install a new one (See "Print media specifications" on page 92). If the problem persists, the machine may require repair. Contact a service representative.
<p>Curl</p> 	<p>If the printed paper is curled or paper does not feed into the machine:</p> <ul style="list-style-type: none"> Turn over the stack of paper in the tray. Also try rotating the paper 180° in the tray. Change the printer option and try again. Go to printer properties, click Paper tab and set type to Thin Paper. Refer to the "Opening printing preferences" on page 60 for details.
<p>An unknown image repetitively appears on a next few sheets or loose toner, light print, or contamination occurs.</p>	<p>Your machine is probably being used at an altitude of 1,000 m (3,281 ft.) or above. The high altitude may affect the print quality such as loose toner or light imaging. You can set this option through Printer Setting Utility (See "Altitude adjustment" on page 50).</p>

Common Windows problems

Condition	Suggested solutions
<p>"File in Use" message appears during installation.</p>	<p>Exit all software applications. Remove all software from the startup group, then restart Windows. Reinstall the printer driver.</p>
<p>"General Protection Fault", "Exception OE", "Spool 32", or "Illegal Operation" messages appear.</p>	<p>Close all other applications, reboot Windows and try printing again.</p>
<p>"Fail To Print", "A printer timeout error occurred" messages appear.</p>	<p>These messages may appear during printing. Just keep waiting until the machine finishes printing. If the message appears in ready mode or after printing has been completed, check the connection and/or whether an error has occurred.</p>

 Refer to the Microsoft Windows User's Guide that came with your computer for further information on Windows error messages.

Common Linux problems

condition	Suggested solutions
<p>The machine does not print.</p>	<ul style="list-style-type: none"> Check if the printer driver is installed in your system. Open Unified Driver Configurator and switch to the Printers tab in Printers configuration window to look at the list of available machines. Make sure that your machine is displayed on the list. If not, open Add new printer wizard to set up your device. Check if the machine is started. Open Printers configuration and select your machine on the printers list. Look at the description in the Selected printer pane. If its status contains Stopped string, press the Start button. After that normal operation of the machine should be restored. The "stopped" status might be activated when some problems in printing occur. For instance, this could be an attempt to print a document when the port is claimed by a scanning application. Ensure the port is not busy. Since functional components of machine (printer and scanner) share the same I/O interface (port), the situation of simultaneous access of different user applications to the same port is possible. To avoid possible conflicts, only one of them at a time is allowed to gain control over the device. The other user will encounter "device busy" response. You should open ports configuration and select the port assigned to your machine. In the Selected port pane you can see if the port is occupied by some other application. If this is the case, you should either wait for completion of the current job or press the Release port button, if you are sure that the present application is not functioning properly. Check if your application has special print option such as "-oraw". If "-oraw" is specified in the command line parameter, then remove it to print properly. For Gimp front-end, select "print" -> "Setup printer" and edit command line parameter in the command item. The CUPS (Common UNIX Printing System) version distributed with SuSE Linux 9.2 (cups-1.1.21) has a problem with ipp (Internet Printing Protocol) printing. Use the socket printing instead of ipp or install a later version of CUPS (cups-1.1.22 or higher).

condition	Suggested solutions
Some color images come out all black.	This is a known bug in Ghostscript (until GNU Ghostscript version 7.05) when the base color space of the document is indexed color space and it is converted through CIE color space. Because Postscript uses CIE color space for Color Matching System, you should upgrade Ghostscript on your system to at least GNU Ghostscript version 7.06 or later. You can find recent Ghostscript versions at www.ghostscript.com .
Some color images come out in unexpected color.	This is a known bug in Ghostscript (until GNU Ghostscript version 7.xx) when the base color space of the document is indexed RGB color space and it is converted through CIE color space. Because Postscript uses CIE color space for Color Matching System, you should upgrade Ghostscript on your system to at least GNU Ghostscript version 8.xx or later. You can find recent Ghostscript versions at www.ghostscript.com .
The machine does not print whole pages, and output is printed on half the page.	It is a known problem that occurs when a color machine is used on version 8.51 or earlier of Ghostscript, 64-bit Linux OS, and has been reported to bugs.ghostscript.com as Ghostscript Bug 688252. The problem is solved in AFPL Ghostscript v. 8.52 or above. Download the latest version of AFPL Ghostscript from http://sourceforge.net/projects/ghostscript/ and install it to solve this problem.
I encounter the "Cannot open port device file" error when printing a document.	Avoid changing print job parameters (via LPR GUI, for example) while a print job is in progress. Known versions of CUPS server break the print job whenever print options are changed and then try to restart the job from the beginning. Since Unified Linux Driver locks the mfp port while printing, the abrupt termination of the driver keeps the port locked and unavailable for subsequent print jobs. If this situation occurs, try to release the mfp port by selecting Release port in Port configuration window.

 Refer to the Linux User's Guide that came with your computer for further information on Linux error messages.

Common Macintosh problems

condition	Suggested solutions
The machine does not print PDF files correctly. Some parts of graphics, text, or illustrations are missing.	Printing the PDF file as an image may enable the file to print. Turn on Print As Image from the Acrobat printing options.  It will take longer to print when you print a PDF file as an image.

condition	Suggested solutions
The document has printed, but the print job has not disappeared from the spooler in Mac OS X 10.3.2.	Update your Mac OS to OS Mac OS X 10.3.3. or higher.
Some letters are not displayed normally during the Cover page printing.	Mac OS cannot create the font during the Cover page printing. The English alphabet and numbers are displayed normally on the Cover page.
When printing a document in Macintosh with Acrobat Reader 6.0 or higher, colors print incorrectly.	Make sure that the resolution setting in your machine driver matches the one in Acrobat Reader.

 Refer to the Macintosh User's Guide that came with your computer for further information on Macintosh error messages.

This chapter provides information about purchasing supplies and maintenance parts available for your machine.

This chapter includes:

- How to purchase
- Available supplies
- Maintenance parts

 Available accessories may differ from country to country. Contact your sales representatives to obtain the list of available accessories.

How to purchase

To order Genuine Samsung supplies, accessories and, maintenance parts, contact your local Samsung dealer or the authorized retailer where you purchased your machine. You can also visit www.samsung.com/supplies, select your country/region, and obtain information on calling for service.

Available supplies

When supplies reach their lifespan, you can order the following types of supplies for your machine:

Type	Average yield ^a	Part name
Standard yield toner cartridge	<ul style="list-style-type: none"> • Average continuous black cartridge yield: 1,500 standard pages (Black) • Average continuous color cartridge yield: 1,000 standard pages (Yellow/Magenta/Cyan) 	K407(CLT-K407S): Black C407(CLT-C407S): Cyan M407(CLT-M407S): Magenta Y407(CLT-Y407S): Yellow Region A^b K4072(CLT-K4072S): Black C4072(CLT-C4072S): Cyan M4072(CLT-M4072S): Magenta Y4072(CLT-Y4072S): Yellow Region B^c K4073(CLT-K4073S): Black C4073(CLT-C4073S): Cyan M4073(CLT-M4073S): Magenta Y4073(CLT-Y4073S): Yellow
Imaging Unit	Approx. 24,000 images ^d	CLT-R407
Waste toner container	Approx. 10,000 images ^d	CLT-W409

a. Declared yield value in accordance with ISO/IEC 19798.

b. Region A: Albania, Austria, Belgium, Bosnia, Bulgaria, Croatia, Cyprus, Czech Republic, Denmark, Estonia, Finland, France, Germany, Greece, Hungary, Italy, Latvia, Lithuania, Macedonia, Netherlands, Norway, Poland, Portugal, Romania, Serbia, Slovakia, Slovenia, Spain, Sweden, Switzerland and UK

c. Region B: Bangladesh, China, India, and Nepal

d. Image counts based on one color on each page. If you print documents in full color (Cyan, Magenta, Yellow, Black), the life of this item will be reduced by 25%.

- Replacing the toner cartridge
- Replacing the imaging unit
- Replacing the waste toner container

To replace a toner cartridge, see "Replacing the toner cartridge" on page 86.

 Depending on the options and percentage of image area, job mode used, the toner cartridge's lifespan may differ.

 You must purchase supplies, including toner cartridges, in the same country where you purchased your machine. Otherwise, supplies will be incompatible with your machine since the system configurations vary from country to country.

 Samsung does not recommend using non-genuine Samsung toner cartridge such as refilled or remanufactured. Samsung cannot guarantee non-genuine Samsung toner cartridge's quality. Service or repair required as a result of using non-genuine Samsung toner cartridges will not be covered under the machine warranty.

Maintenance parts

To purchase maintenance parts, contact the source where you bought the machine.

Replacing maintenance parts can be performed only by an authorized service provider, dealer, or the retailer where you bought the machine. The warranty does not cover the replacement of any maintenance parts once it has reached its "Average Yield".

Maintenance parts are replaced at specific intervals to avoid print quality and paper feed problems resulting from worn parts, see table below. The purpose of which is to maintain your machine in top working condition. The maintenance parts below should be replaced when the life span of each item has been met.

Parts	Average yield ^a
Fuser unit	Approx. 50,000 pages (B&W)/ 12,500 pages (Color)
Transfer roller	Approx. 50,000 pages (B&W)/ 12,500 pages (Color)
Transfer belt (ITB)	Approx. 50,000 pages (B&W)/ 12,500 pages (Color)
Paper feed roller	Approx. 50,000 pages

a. It will be affected by operating system used, computing performance, application software, connecting method, media type, media size and job complexity.

Replacing the toner cartridge

 Click this link to open an animation about replacing a toner cartridge.

The machine uses four colors and has a different toner cartridge for each one: yellow (Y), magenta (M), cyan (C) and black (K).

A toner cartridge has reached its estimated cartridge life. The printer stops printing. Also, the Smart Panel program window appears on the computer telling you to replace the cartridge (See "Using the Smart Panel program" on page 69).

At this stage, the toner cartridge needs to be replaced. Check the model number for the toner cartridge used in your machine (See "Available supplies" on page 86).

 Samsung does not recommend using non-genuine Samsung toner cartridge such as refilled or remanufactured. Samsung cannot guarantee non-genuine Samsung toner cartridge's quality or damages it can cause to the machine. Also service or repair required as a result of using non-genuine Samsung toner cartridges will not be covered under the machine warranty.

1. Turn the machine off, then wait a few minutes for the machine to cool.
2. Press the release button, completely open the front cover.

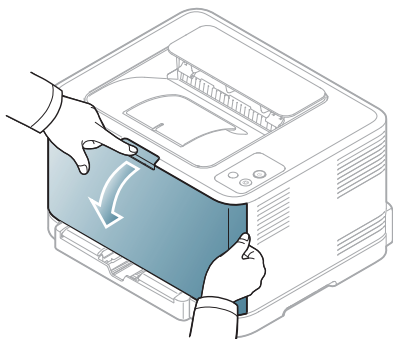

3. Grasp the handles on the toner cartridge and pull to remove the cartridge from the machine.

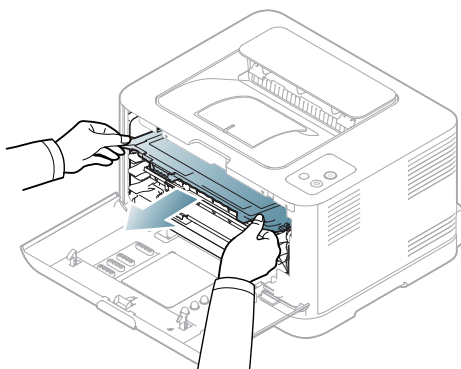

4. Take a new toner cartridge out of its package.
5. Pull out the hopper sheet from a new toner cartridge.

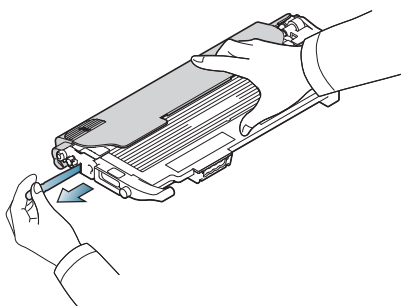

6. Holding both handles a new toner cartridge, thoroughly rock it from side to side to evenly distribute the toner.

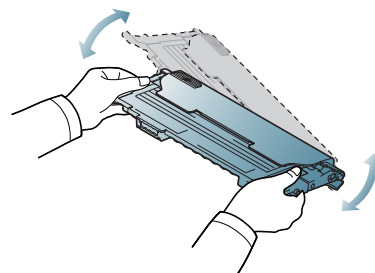

7. Place the toner cartridge on a flat surface as shown below and remove the protecting cover.

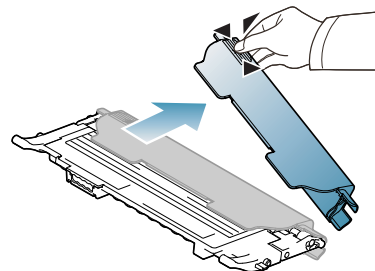

 If toner gets on your clothing, wipe it off with a dry cloth and wash it in cold water. Hot water sets toner into fabric.

8. Make sure that the color of the toner cartridge matches the color slot and then grasp the handles on the toner cartridge. Insert the cartridge until it clicks into place.

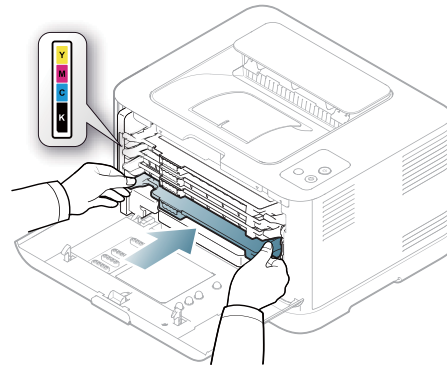

9. Close the front cover. Make sure the cover is securely latched and then turn the machine on.

 If the front cover is not completely closed, the machine will not operate.

Replacing the imaging unit

When the life span of the imaging unit has expired, the Smart Panel program window appears on the computer, indicating the imaging unit needs to be placed. Otherwise, your machine stops printing.

1. Turn the machine off, then wait a few minutes for the machine to cool.
2. Press the release button, completely open the front cover.

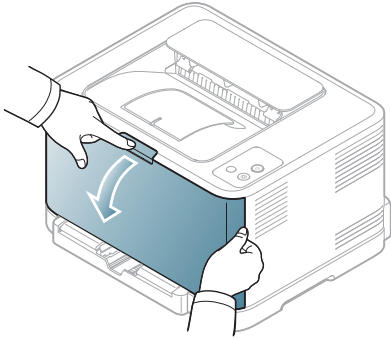

3. Grasp the handles on the toner cartridge and pull to remove the cartridge from the machine.

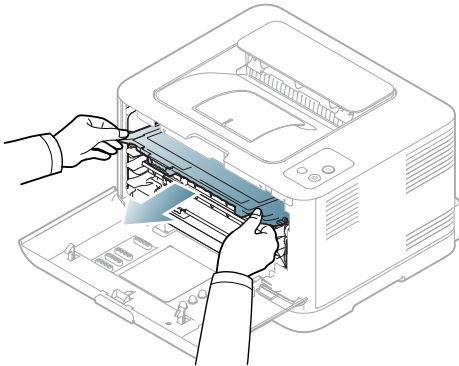

4. Pull the waste toner container out of the machine using its handle.

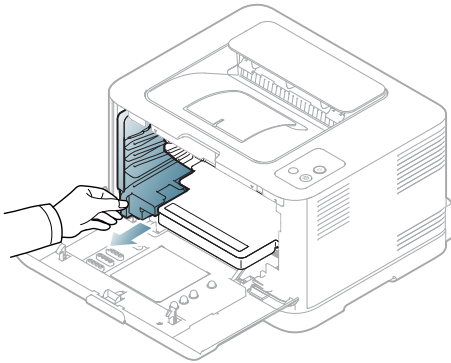

5. Pull the imaging unit out of the machine using the groove on the front of the imaging unit.

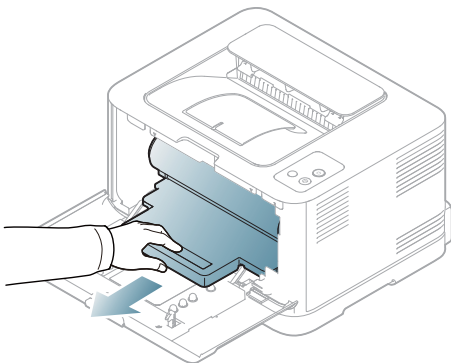

6. Take a new imaging unit out of its package.



- Don't use sharp objects such as a knife or scissors to open the imaging unit package. You could damage the surface of the imaging unit.
- Be careful not to scratch the surface of the imaging unit.
- To prevent damage, do not expose the imaging unit to light for more than a few minutes. Cover it with a piece of paper to protect it if necessary.

7. Holding the groove on the front of the imaging unit, push imaging unit into the machine.

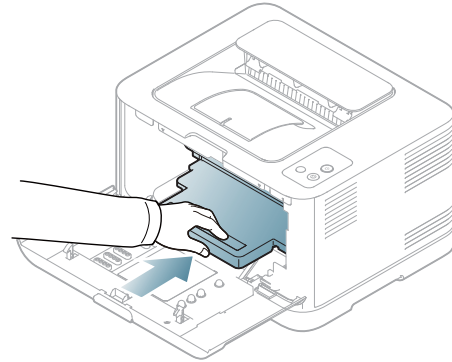

8. Insert the waste toner container into position and then push it to make sure that it is firmly seated in place.

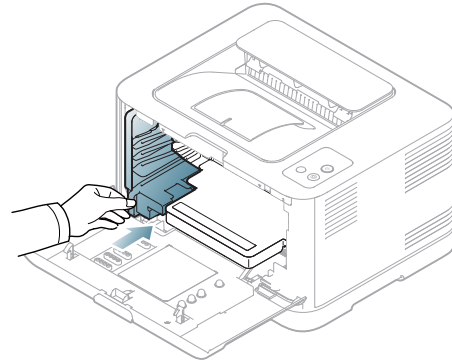

9. Slide the toner cartridge back into the machine.

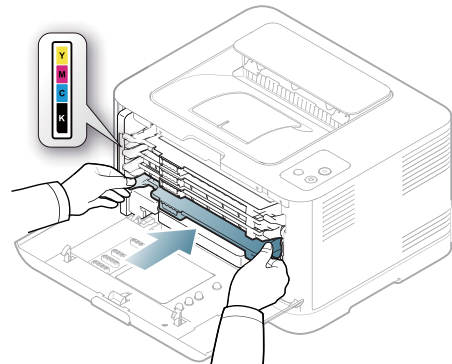

10. Close the front cover firmly.



- If the front cover is not completely closed, the machine will not operate. Please make sure all toner cartridges are installed properly. If any toner cartridge is installed improperly, the front cover do not close.

11. Turn the machine on.

-  Each LED blinks red in a repeated order. Wait for about 1.5 minutes for your machine to get ready.

Replacing the waste toner container

When the life span of the waste toner container has expired, the Smart Panel program window appears on the computer, indicating the waste toner container needs to be replaced. Otherwise, your machine stops printing.

1. Turn the machine off, then wait a few minutes for the machine to cool.
2. Open the front cover.

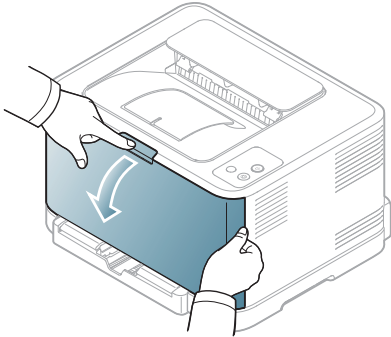

3. Pull the waste toner container out of the machine using its handle.

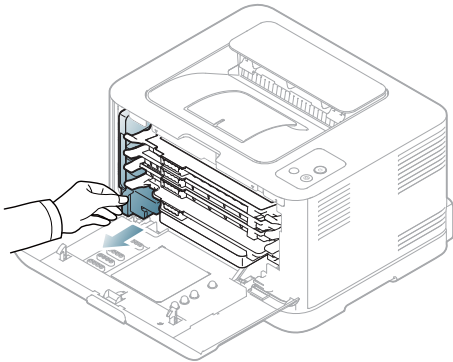

-  Make sure that you lay the waste toner container on a flat surface so that the toner dose not spill.

4. Remove the container's cap from the container as shown below and use it to close the waste toner container opening.

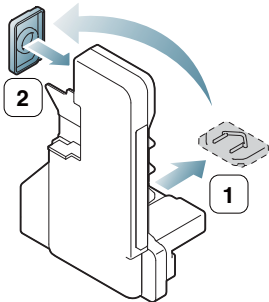

-  Do not tilt or turn over the container.

5. Take a new waste toner container out of its package.

6. Insert the new container into position and then push it to make sure that it is firmly seated in place.

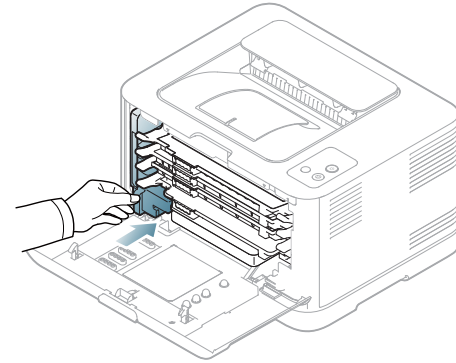

7. Close the front cover firmly.

-  If the front cover is not completely closed, the machine will not operate. Please, make sure all toner cartridges are installed properly. If any toner cartridge is installed improperly, the front cover do not close.

8. Turn the machine on.

specifications

This chapter covers the machine's primary specifications.

This chapter includes:

- Hardware specifications
- Environmental specifications
- Electrical specifications
- Print media specifications

 The specification values are listed below: specification are subject to change without notice: See www.samsung.com/printer for possible changes in information.

Hardware specifications

Item		Description
Dimension	Height	243 mm (9.57 inches)
	Depth	313 mm (12.32 inches)
	Width	388 mm (15.28 inches)
Weight	Machine with consumables	11 Kg (24.25 lbs)
Package weight	Paper	1.50 Kg (3.31 lbs)
	Plastic	0.45 Kg (0.99 lbs)
Wireless^a	Module	CLX-NWA20L

a. CLP-325W(K)/CLP-326W only.

Environmental specifications

Item		Description
Noise Level^a	Ready mode	Background noise level
	Printing mode	Less than 45 dBA (Color printing) Less than 47 dBA (Black and White printing)
Temperature	Operation	10 to 32 °C (50 to 89.6 °F)
	Storage (Packed)	0 to 40 °C (32 to 104 °F)
Humidity	Operation	20 to 80% RH
	Storage (Packed)	10 to 90% RH

a. Sound Pressure Level, ISO 7779. Configuration tested: machine basic installation, A4 paper, simplex printing.

Electrical specifications

 Power requirements are based on the country/region where the device is sold. Do not convert operating voltages. Doing so might damage the device and void the product warranty.

Item		Description
Power rating^a	110 volt models	AC 110 - 127 V
	220 volt models	AC 220 - 240 V
Power consumption	Average operating mode	Less than 350 W
	Ready mode	Less than 60 W
	Power save mode	<ul style="list-style-type: none"> • CLP-320(K)/CLP-321/CLP-325(K)/ CLP-326: Less than 5 W • CLP-320N(K)/CLP-321N: Less than 6 W • CLP-325W(K)/CLP-326W: Less than 7 W
	Power off mode	Less than 0.45 W

a. See the rating label on the machine for the correct voltage, frequency (hertz) and type of current for your machine.

Print media specifications

Type	Size	Dimensions	Weight ^a	Capacity ^b
Plain paper	Letter	216 x 279 mm (8.50 x 11.00 inches)	70 to 90 g/m ² (19 to 24 lbs bond).	130 sheets of 80 g/m ² (21 lbs bond) paper for the tray.
	Legal	216 x 356 mm (8.50 x 14.00 inches)		
	US Folio	216 x 330 mm (8.50 x 13.00 inches)		
	A4	210 x 297 mm (8.26 x 11.69 inches)		
	Oficio	216 x 343 mm (8.50 x 13.50 inches)		
	JIS B5	182 x 257 mm (7.17 x 10.12 inches)		
	ISO B5	176 x 250 mm (6.93 x 9.84 inches)		
	Executive	184 x 267 mm (7.25 x 10.5 inches)		
	A5	148 x 210 mm (5.83 x 8.27 inches)		
	A6	105 x 148 mm (4.13 x 5.83 inches)		
Envelope	Monarch	98 x 191 mm (3.87 x 7.50 inches)	75 to 90 g/m ² (20 to 24 lbs bond) for manual feeding in the tray.	5 sheets for manual feeding in the tray.
	No. 10	105 x 241 mm (4.12 x 9.50 inches)		
	DL	110 x 220 mm (4.33 x 8.66 inches)		
	C5	162 x 229 mm (6.38 x 9.02 inches)		
	C6	114 x 162 mm (4.49 x 6.38 inches)		
	No.9	98 x 225 mm (3.87 x 8.87 inches)		
	6 3/4	92 x 165 mm (3.62 x 6.50 inches)		
Thick paper	Refer to the Plain paper section	Refer to the Plain paper section	90 to 105 g/m ² (24 to 28 lbs bond) for manual feeding in the tray.	5 sheets for manual feeding in the tray.
Thin paper	Refer to the Plain paper section	Refer to the Plain paper section	60 to 70 g/m ² (16 to 19 lbs bond) for manual feeding in the tray.	
Labels^c	Letter, A4	Refer to the Plain paper section	120 to 150 g/m ² (32 to 40 lbs bond) for manual feeding in the tray.	
Card stock	PostCard	101.60 x 152.4 mm (4 x 6 inches)	105 to 163 g/m ² (28 to 43 lbs bond) for manual feeding in the tray.	
Transparency^{d e f}	Letter, A4,	Refer to the Plain paper section	-	1 sheet for manual feeding in the tray
Glossy Photo^g	Letter, A4	Refer to the Pain paper section	111 to 220 g/m ² (30 to 58 lbs bond) for manual feeding in the tray.	
Matte Photo	Letter, A4, PostCard 4 x 6	Refer to the Pain paper section	111 to 220 g/m ² (30 to 58 lbs bond) for manual feeding in the tray.	
Minimum size (custom)		76 x 152.4 mm (3.00 x 6.00 inches)	60 to 163 g/m ² (16 to 43 lbs bond)	
Maximum size (custom)		216 x 356 mm (8.50 x 14.02 inches)		

a. If media weight is over 120 g/m² (32 lbs bond), load a paper into the tray one by one.

b. Maximum capacity may differ depending on media weight, thickness and environmental conditions.

c. Smoothness: 100 to 250 (sheffield). This means the numeric level of smoothness.

d. Recommended media: Transparency for a color laser printer by **Xerox 3R91331 (A4)**, **Xerox 3R2780 (Letter)**.

e. Recommended media: 0.104 to 0.124 mm (0.004094 to 0.004882 inches) transparency paper.

f. In case of color printing using transparencies, the picture quality would be lower than mono printing when the printouts are used on the overhead projector.

g. Recommended media: Glossy paper (Letter) for this machine by **HP Brochure Paper** (Product: Q6611A). Glossy paper (A4) for this machine by **HP Superior Paper 160 glossy** (Product: Q6616A).

contact samsung worldwide

If you have any comments or questions regarding Samsung products, contact the Samsung customer care center.

Country/Region	Customer Care Center	Web Site
ARGENTINE	0800-333-3733	www.samsung.com
ARMENIA	0-800-05-555	
AUSTRALIA	1300 362 603	www.samsung.com
AUSTRIA	0810-SAMSUNG (7267864, € 0.07/min)	www.samsung.com
AZERBAIJAN	088-55-55-555	
BAHRAIN	8000-4726	
BELARUS	810-800-500-55-500	www.samsung.ua www.samsung.com/ua_ru
BELGIUM	02-201-24-18	www.samsung.com/be (Dutch) www.samsung.com/be_fr (French)
BRAZIL	0800-124-421 4004-0000	www.samsung.com
CANADA	1-800-SAMSUNG (726-7864)	www.samsung.com
CHILE	800-SAMSUNG (726-7864)	www.samsung.com
CHINA	400-810-5858 010-6475 1880	www.samsung.com
COLOMBIA	01-8000112112	www.samsung.com
COSTA RICA	0-800-507-7267	www.samsung.com
CZECH REPUBLIC	800-SAMSUNG (800-726786) Samsung Zrt., česká organizační složka, Oasis Florenc, Sokolovská394/17, 180 00, Praha 8	www.samsung.com
DENMARK	70 70 19 70	www.samsung.com
ECUADOR	1-800-10-7267	www.samsung.com
EGYPT	0800-726786	
EIRE	0818 717100	www.samsung.com
EL SALVADOR	800-6225	www.samsung.com
ESTONIA	800-7267	www.samsung.com
KAZAKHSTAN	8-10-800-500-55-500	www.samsung.com/kz_ru
KYRGYZSTAN	00-800-500-55-500	
FINLAND	030-6227 515	www.samsung.com
FRANCE	01 48 63 00 00	www.samsung.com

Country/Region	Customer Care Center	Web Site
GERMANY	01805 - SAMSUNG (726-7864 € 0,14/min)	www.samsung.com
GEORGIA	8-800-555-555	
GUATEMALA	1-800-299-0013	www.samsung.com
HONDURAS	800-7919267	www.samsung.com
HONG KONG	(852) 3698-4698	www.samsung.com/hk www.samsung.com/hk_en/
HUNGARY	06-80-SAMSUNG (726-7864)	www.samsung.com
INDIA	3030 8282 1800 110011 1800 3000 8282 1800 266 8282	www.samsung.com
INDONESIA	0800-112-8888 021-5699-7777	www.samsung.com
ITALIA	800-SAMSUNG (726-7864)	www.samsung.com
JAMAICA	1-800-234-7267	www.samsung.com
JAPAN	0120-327-527	www.samsung.com
JORDAN	800-22273	
KSA	9200-21230	www.samsung.com
BAHRAIN	8000-4726	
LATVIA	8000-7267	www.samsung.com
LITHUANIA	8-800-77777	www.samsung.com
LUXEMBURG	261 03 710	www.samsung.com
MALAYSIA	1800-88-9999	www.samsung.com
MEXICO	01-800-SAMSUNG (726-7864)	www.samsung.com
MOLDOVA	00-800-500-55-500	www.samsung.ua www.samsung.com/ua_ru
NETHERLANDS	0900-SAMSUNG (0900-7267864) (€ 0,10/min)	www.samsung.com
NEW ZEALAND	0800 SAMSUNG (0800 726 786)	www.samsung.com
NICARAGUA	00-1800-5077267	www.samsung.com
NORWAY	815-56 480	www.samsung.com
PANAMA	800-7267	www.samsung.com

Country/Region	Customer Care Center	Web Site
PHILIPPINES	1800-10-SAMSUNG (726-7864) 1-800-3-SAMSUNG (726-7864) 1-800-8-SAMSUNG (726-7864) 02-5805777	www.samsung.com
POLAND	0 801 1SAMSUNG (172678) 022-607-93-33	www.samsung.com
PORTUGAL	80820-SAMSUNG (726-7864)	www.samsung.com
PUERTO RICO	1-800-682-3180	www.samsung.com
QATAR	800-2255	
REP. DOMINICA	1-800-751-2676	www.samsung.com
RUSSIA	8-800-555-55-55	www.samsung.ru
SINGAPORE	1800-SAMSUNG (726-7864)	www.samsung.com
SLOVAKIA	0800-SAMSUNG (726-7864)	www.samsung.com
SOUTH AFRICA	0860 SAMSUNG (726-7864)	www.samsung.com
SPAIN	902-1-SAMSUNG(902 172 678)	www.samsung.com
SWEDEN	0771 726 7864 (SAMSUNG)	www.samsung.com
SWITZERLAND	0848-SAMSUNG (7267864, CHF 0.08/min)	www.samsung.com
SYRIA	1825-22-73	
TADJIKISTAN	8-10-800-500-55-500	
TAIWAN	0800-329-999	www.samsung.com
THAILAND	1800-29-3232 02-689-3232	www.samsung.com
TRINIDAD & TOBAGO	1-800-SAMSUNG (726-7864)	www.samsung.com
TURKEY	444 77 11	www.samsung.com
U.A.E	800-SAMSUNG (726-7864)	www.samsung.com
U.K	0845 SAMSUNG (726-7864)	www.samsung.com
U.S.A	1-800-SAMSUNG (726-7864)	www.samsung.com
UKRAINE	8-800-502-000	www.samsung.ua www.samsung.com/ua_ru

Country/Region	Customer Care Center	Web Site
UZBEKISTAN	8-10-800-500-55-500	www.samsung.com/kz_ru
VENEZUELA	0-800-100-5303	www.samsung.com
VIETNAM	1 800 588 889	www.samsung.com

 The following glossary helps you get familiar with the product by understanding the terminologies commonly used with printing as well as mentioned in this user's guide.

802.11

802.11 is a set of standards for wireless local area network (WLAN) communication, developed by the IEEE LAN/MAN Standards Committee (IEEE 802).

802.11b/g/n

802.11b/g/n can share same hardware and use the 2.4 GHz band. 802.11b supports bandwidth up to 11 Mbps, 802.11n supports bandwidth up to 150 Mbps. 802.11b/g/n devices may occasionally suffer interference from microwave ovens, cordless telephones, and Bluetooth devices.

Access point

Access Point or Wireless Access Point (AP or WAP) is a device that connects wireless communication devices together on wireless local area networks (WLAN), and acts as a central transmitter and receiver of WLAN radio signals.

ADF

An Automatic Document Feeder (ADF) is a scanning unit that will automatically feed an original sheet of paper so that the machine can scan some amount of the paper at once.

AppleTalk

AppleTalk is a proprietary suite of protocols developed by Apple, Inc for computer networking. It was included in the original Macintosh (1984) and is now deprecated by Apple in favor of TCP/IP networking.

BIT Depth

A computer graphics term describing the number of bits used to represent the color of a single pixel in a bitmapped image. Higher color depth gives a broader range of distinct colors. As the number of bits increases, the number of possible colors becomes impractically large for a color map. 1-bit color is commonly called as monochrome or black and white.

BMP

A bitmapped graphics format used internally by the Microsoft Windows graphics subsystem (GDI), and used commonly as a simple graphics file format on that platform.

BOOTP

Bootstrap Protocol. A network protocol used by a network client to obtain its IP address automatically. This is usually done in the bootstrap process of computers or operating systems running on them. The BOOTP servers assign the IP address from a pool of addresses to each

client. BOOTP enables 'diskless workstation' computers to obtain an IP address prior to loading any advanced operating system.

CCD

Charge Coupled Device (CCD) is a hardware which enables the scan job. CCD Locking mechanism is also used to hold the CCD module to prevent any damage when you move the machine.

Collation

Collation is a process of printing a multiple-copy job in sets. When collation is selected, the device prints an entire set before printing additional copies.

Control Panel

A control panel is a flat, typically vertical, area where control or monitoring instruments are displayed. They are typically found in front of the machine.

Coverage

It is the printing term used for a toner usage measurement on printing. For example, 5% coverage means that an A4 sided paper has about 5% image or text on it. So, if the paper or original has complicated images or lots of text on it, the coverage will be higher and at the same time, a toner usage will be as much as the coverage.

CSV

Comma Separated Values (CSV). A type of file format, CSV is used to exchange data between disparate applications. The file format, as it is used in Microsoft Excel, has become a de facto standard throughout the industry, even among non-Microsoft platforms.

DADF

A Duplex Automatic Document Feeder (DADF) is a scanning unit that will automatically feed and turn over an original sheet of paper so that the machine can scan on both sides of the paper.

Default

The value or setting that is in effect when taking a printer out of its box state, reset, or initialized.

DHCP

A Dynamic Host Configuration Protocol (DHCP) is a client-server networking protocol. A DHCP server provides configuration parameters specific to the DHCP client host requesting, generally, information required by the client host to participate on an IP network. DHCP also provides a mechanism for allocation of IP addresses to client hosts.

DIMM

Dual Inline Memory Module (DIMM), a small circuit board that holds memory. DIMM stores all the data within the machine like printing data, received fax data.

DLNA

The Digital Living Network Alliance (DLNA) is a standard that allows devices on a home network to share information with each other across the network.

DMPr

The Digital Media Printer (DMPr) is a device that allows printing in DLNA home network. The DMPr prints a page by combining images with an Extensible HyperText Markup Language (XHTML) template.

DNS

The Domain Name Server (DNS) is a system that stores information associated with domain names in a distributed database on networks, such as the Internet.

Dot Matrix Printer

A dot matrix printer refers to a type of computer printer with a print head that runs back and forth on the page and prints by impact, striking an ink-soaked cloth ribbon against the paper, much like a typewriter.

DPI

Dots Per Inch (DPI) is a measurement of resolution that is used for scanning and printing. Generally, higher DPI results in a higher resolution, more visible detail in the image, and a larger file size.

DRPD

Distinctive Ring Pattern Detection. Distinctive Ring is a telephone company service which enables a user to use a single telephone line to answer several different telephone numbers.

Duplex

A mechanism that will automatically turn over a sheet of paper so that the machine can print (or scan) on both sides of the paper. A printer equipped with a Duplex Unit can print on both sides of paper during one print cycle.

Duty Cycle

Duty cycle is the page quantity which does not affect printer performance for a month. Generally the printer has the lifespan limitation such as pages per year. The lifespan means the average capacity of print-outs, usually within the warranty period. For example, if the duty cycle is 48,000 pages per month assuming 20 working days, a printer limits 2,400 pages a day.

ECM

Error Correction Mode (ECM) is an optional transmission mode built into Class 1 fax machines or fax modems. It automatically detects and corrects errors in the fax transmission process that are sometimes caused by telephone line noise.

Emulation

Emulation is a technique of one machine obtaining the same results as another.

An emulator duplicates the functions of one system with a different system, so that the second system behaves like the first system. Emulation focuses on exact reproduction of external behavior, which is in contrast to simulation, which concerns an abstract model of the system being simulated, often considering its internal state.

Ethernet

Ethernet is a frame-based computer networking technology for local area networks (LANs). It defines wiring and signaling for the physical layer, and frame formats and protocols for the media access control (MAC)/data link layer of the OSI model. Ethernet is mostly standardized as IEEE 802.3. It has become the most widespread LAN technology in use during the 1990s to the present.

EtherTalk

A suite of protocols developed by Apple Computer for computer networking. It was included in the original Macintosh (1984) and is now deprecated by Apple in favor of TCP/IP networking.

FDI

Foreign Device Interface (FDI) is a card installed inside the machine to allow a third party device such as a coin operated device or a card reader. Those devices allow the pay-for-print service on your machine.

FTP

A File Transfer Protocol (FTP) is a commonly used protocol for exchanging files over any network that supports the TCP/IP protocol (such as the Internet or an intranet).

Fuser Unit

The part of a laser printer that fuses the toner onto the print media. It consists of a heat roller and a pressure roller. After toner is transferred onto the paper, the fuser unit applies heat and pressure to ensure that the toner stays on the paper permanently, which is why paper is warm when it comes out of a laser printer.

Gateway

A connection between computer networks, or between a computer network and a telephone line. It is very popular, as it is a computer or a network that allows access to another computer or network.

Grayscale

A shades of gray that represent light and dark portions of an image when color images are converted to grayscale; colors are represented by various shades of gray.

Halftone

An image type that simulates grayscale by varying the number of dots. Highly colored areas consist of a large number of dots, while lighter areas consist of a smaller number of dots.

HDD

Hard Disk Drive (HDD), commonly referred to as a hard drive or hard disk, is a non-volatile storage device which stores digitally-encoded data on rapidly rotating platters with magnetic surfaces.

IEEE

The Institute of Electrical and Electronics Engineers (IEEE) is an international non-profit, professional organization for the advancement of technology related to electricity.

IEEE 1284

The 1284 parallel port standard was developed by the Institute of Electrical and Electronics Engineers (IEEE). The term "1284-B" refers to a specific connector type on the end of the parallel cable that attaches to the peripheral (for example, a printer).

Intranet

A private network that uses Internet Protocols, network connectivity, and possibly the public telecommunication system to securely share part of an organization's information or operations with its employees. Sometimes the term refers only to the most visible service, the internal website.

IP address

An Internet Protocol (IP) address is a unique number that devices use in order to identify and communicate with each other on a network utilizing the Internet Protocol standard.

IPM

The Images Per Minute (IPM) is a way of measuring the speed of a printer. An IPM rate indicates the number of single-sided sheets a printer can complete within one minute.

IPP

The Internet Printing Protocol (IPP) defines a standard protocol for printing as well as managing print jobs, media size, resolution, and so forth. IPP can be used locally or over the Internet to hundreds of printers, and also supports access control, authentication, and encryption, making it a much more capable and secure printing solution than older ones.

IPX/SPX

IPX/SPX stands for Internet Packet Exchange/Sequenced Packet Exchange. It is a networking protocol used by the Novell NetWare operating systems. IPX and SPX both provide connection services similar to TCP/IP, with the IPX protocol having similarities to IP, and SPX having similarities to TCP. IPX/SPX was primarily designed for local area networks (LANs), and is a very efficient protocol for this purpose (typically its performance exceeds that of TCP/IP on a LAN).

ISO

The International Organization for Standardization (ISO) is an international standard-setting body composed of representatives from national standards bodies. It produces world-wide industrial and commercial standards.

ITU-T

The International Telecommunication Union is an international organization established to standardize and regulate international radio and telecommunications. Its main tasks include standardization, allocation of the radio spectrum, and organizing interconnection arrangements between different countries to allow international phone calls. A -T out of ITU-T indicates telecommunication.

ITU-T No. 1 chart

Standardized test chart published by ITU-T for document facsimile transmissions.

JBIG

Joint Bi-level Image Experts Group (JBIG) is an image compression standard with no loss of accuracy or quality, which was designed for compression of binary images, particularly for faxes, but can also be used on other images.

JPEG

Joint Photographic Experts Group (JPEG) is a most commonly used standard method of lossy compression for photographic images. It is the format used for storing and transmitting photographs on the World Wide Web.

LDAP

The Lightweight Directory Access Protocol (LDAP) is a networking protocol for querying and modifying directory services running over TCP/IP.

LED

A Light-Emitting Diode (LED) is a semiconductor device that indicates the status of a machine.

MAC address

Media Access Control (MAC) address is a unique identifier associated with a network adapter. MAC address is a unique 48-bit identifier usually written as 12 hexadecimal characters grouped in pairs (e. g., 00-00-0c-34-11-4e). This address is usually hard-coded into a Network Interface Card (NIC) by its manufacturer, and used as an aid for routers trying to locate machines on large networks.

MFP

Multi Function Peripheral (MFP) is an office machine that includes the following functionality in one physical body, so as to have a printer, a copier, a fax, a scanner and etc.

MH

Modified Huffman (MH) is a compression method for decreasing the amount of data that needs to be transmitted between the fax machines to transfer the image recommended by ITU-T T.4. MH is a codebook-based run-length encoding scheme optimized to efficiently compress white space. As most faxes consist mostly of white space, this minimizes the transmission time of most faxes.

MMR

Modified Modified READ (MMR) is a compression method recommended by ITU-T T.6.

Modem

A device that modulates a carrier signal to encode digital information, and also demodulates such a carrier signal to decode transmitted information.

MR

Modified Read (MR) is a compression method recommended by ITU-T T.4. MR encodes the first scanned line using MH. The next line is compared to the first, the differences determined, and then the differences are encoded and transmitted.

NetWare

A network operating system developed by Novell, Inc. It initially used cooperative multitasking to run various services on a PC, and the network protocols were based on the archetypal Xerox XNS stack. Today NetWare supports TCP/IP as well as IPX/SPX.

OPC

Organic Photo Conductor (OPC) is a mechanism that makes a virtual image for print using a laser beam emitted from a laser printer, and it is usually green or rust colored and has a cylinder shape.

An imaging unit containing a drum slowly wears the drum surface by its usage in the printer, and it should be replaced appropriately since it gets worn from contact with the cartridge development brush, cleaning mechanism, and paper.

Originals

The first example of something, such as a document, photograph or text, etc, which is copied, reproduced or translated to produce others, but which is not itself copied or derived from something else.

OSI

Open Systems Interconnection (OSI) is a model developed by the International Organization for Standardization (ISO) for communications. OSI offers a standard, modular approach to network design that divides the required set of complex functions into manageable, self-contained, functional layers. The layers are, from top to bottom, Application, Presentation, Session, Transport, Network, Data Link and Physical.

PABX

A private automatic branch exchange (PABX) is an automatic telephone switching system within a private enterprise.

PCL

Printer Command Language (PCL) is a Page Description Language (PDL) developed by HP as a printer protocol and has become an industry standard. Originally developed for early inkjet printers, PCL has been released in varying levels for thermal, dot matrix printer, and laser printers.

PDF

Portable Document Format (PDF) is a proprietary file format developed by Adobe Systems for representing two dimensional documents in a device independent and resolution independent format.

PostScript

PostScript (PS) is a page description language and programming language used primarily in the electronic and desktop publishing areas. - that is run in an interpreter to generate an image.

Printer Driver

A program used to send commands and transfer data from the computer to the printer.

Print Media

The media like paper, envelopes, labels, and transparencies which can be used in a printer, a scanner, a fax or, a copier.

PPM

Pages Per Minute (PPM) is a method of measurement for determining how fast a printer works, meaning the number of pages a printer can produce in one minute.

PRN file

An interface for a device driver, this allows software to interact with the device driver using standard input/output system calls, which simplifies many tasks.

Protocol

A convention or standard that controls or enables the connection, communication, and data transfer between two computing endpoints.

PS

See PostScript.

PSTN

The Public-Switched Telephone Network (PSTN) is the network of the world's public circuit-switched telephone networks which, on industrial premises, is usually routed through the switchboard.

RADIUS

Remote Authentication Dial In User Service (RADIUS) is a protocol for remote user authentication and accounting. RADIUS enables centralized management of authentication data such as usernames and passwords using an AAA (authentication, authorization, and accounting) concept to manage network access.

Resolution

The sharpness of an image, measured in Dots Per Inch (DPI). The higher the dpi, the greater the resolution.

SMB

Server Message Block (SMB) is a network protocol mainly applied to share files, printers, serial ports, and miscellaneous communications

between nodes on a network. It also provides an authenticated Inter-process communication mechanism.

SMTP

Simple Mail Transfer Protocol (SMTP) is the standard for e-mail transmissions across the Internet. SMTP is a relatively simple, text-based protocol, where one or more recipients of a message are specified, and then the message text is transferred. It is a client-server protocol, where the client transmits an email message to the server.

SSID

Service Set Identifier (SSID) is a name of a wireless local area network (WLAN). All wireless devices in a WLAN use the same SSID in order to communicate with each other. The SSIDs are case-sensitive and have a maximum length of 32 characters.

Subnet Mask

The subnet mask is used in conjunction with the network address to determine which part of the address is the network address and which part is the host address.

TCP/IP

The Transmission Control Protocol (TCP) and the Internet Protocol (IP); the set of communications protocols that implement the protocol stack on which the Internet and most commercial networks run.

TCR

Transmission Confirmation Report (TCR) provides details of each transmission such as job status, transmission result and number of pages sent. This report can be set to print after each job or only after failed transmissions.

TIFF

Tagged Image File Format (TIFF) is a variable-resolution bitmapped image format. TIFF describes image data that typically come from scanners. TIFF images make use of tags, keywords defining the characteristics of the image that is included in the file. This flexible and platform-independent format can be used for pictures that have been made by various image processing applications.

Toner Cartridge

A kind of bottle or container used in a machine like a printer which contains toner. Toner is a powder used in laser printers and photocopiers, which forms the text and images on the printed paper. Toner can be fused by a combination of heat/pressure from the fuser, causing it to bind to the fibers in the paper.

TWAIN

An industry standard for scanners and software. By using a TWAIN-compliant scanner with a TWAIN-compliant program, a scan can be initiated from within the program. It is an image capture API for Microsoft Windows and Apple Macintosh operating systems.

UNC Path

Uniform Naming Convention (UNC) is a standard way to access network shares in Window NT and other Microsoft products. The format of a UNC path is: \\<servername>\<sharename>\<Additional directory>

URL

Uniform Resource Locator (URL) is the global address of documents and resources on the Internet. The first part of the address indicates what protocol to use, the second part specifies the IP address or the domain name where the resource is located.

USB

Universal Serial Bus (USB) is a standard that was developed by the USB Implementers Forum, Inc., to connect computers and peripherals. Unlike the parallel port, USB is designed to concurrently connect a single computer USB port to multiple peripherals.

Watermark

A watermark is a recognizable image or pattern in paper that appears lighter when viewed by transmitted light. Watermarks were first introduced in Bologna, Italy in 1282; they have been used by papermakers to identify their product, and also on postage stamps, currency, and other government documents to discourage counterfeiting.

WEP

Wired Equivalent Privacy (WEP) is a security protocol specified in IEEE 802.11 to provide the same level of security as that of a wired LAN. WEP provides security by encrypting data over radio so that it is protected as it is transmitted from one end point to another.

WIA

Windows Imaging Architecture (WIA) is an imaging architecture that is originally introduced in Windows Me and Windows XP. A scan can be initiated from within these operating systems by using a WIA-compliant scanner.

WPA

Wi-Fi Protected Access (WPA) is a class of systems to secure wireless (Wi-Fi) computer networks, which was created to improve upon the security features of WEP.

WPA-PSK

WPA-PSK (WPA Pre-Shared Key) is special mode of WPA for small business or home users. A shared key, or password, is configured in the wireless access point (WAP) and any wireless laptop or desktop devices. WPA-PSK generates a unique key for each session between a wireless client and the associated WAP for more advanced security.

WPS

The Wi-Fi Protected Setup (WPS) is a standard for establishing a wireless home network. If your wireless access point supports WPS, you can configure the wireless network connection easily without a computer.

XPS

XML Paper Specification (XPS) is a specification for a Page Description Language (PDL) and a new document format, which has benefits for portable document and electronic document, developed by Microsoft. It is an XML-based specification, based on a new print path and a vector-based device-independent document format.

A

adjusting
tray size 50

B

booklet printing 61

booklets 61

buttons

- cancel 27
- demo print 27
- power 27
- print screen 26
- wps 27

C

change percentage of your document 62

cleaning

- inside 72
- outside 72

cleaning a machine 72

control panel 25

convention 19

curled 84

D

duplex printing (manual)
printer driver 62

F

favorites settings, for printing 60

features 21

- machine features 90
- power saving feature 51
- supplied software 28

font setting 51

front view 23

G

glossary 96

J

jam

- tips for avoiding paper jams 75

L

LED

- status/toner 26
- wireless 26

Linux

- common Linux problems 84
- driver installation for network connected 39
- printer properties 67
- printing 66
- supplied software 29
- system requirements 30
- unified driver configurator 70

loading

- special media 56

M

Macintosh

- common Macintosh problems 85
- driver installation for network connected 38
- printing 65
- sharing a machine locally 33
- system requirements 29
- using SetIP 35, 47

manual tray

- using special media 56

N

network

- driver installation
 - Linux 39
 - Macintosh 38
 - Windows 37
- installing environment 34
- introducing network programs 34
- IPv4 configuration 35
- IPv6 configuration 36
- SetIP program 35, 47
- using a wired network 34

N-up printing

- Macintosh 66
- Windows 61

O

overlay printing

- create 63
- delete 63
- print 63

P

paper

- changing the size 53

paper type

- setting 58

placing a machine

- adjusting the altitude 50
- spacing 28

poster 61

power saver

- using power save mode 51

print media

- card stock 58
- envelope 57
- glossy paper 58
- labels 57
- output support 92
- special media 56
- transparency 57

print quality problems, solve 81

print resolution set

- Linux 67

print resolution, set

- Macintosh 66

printer driver

- features 59

printer properties

- Linux 67

printing

- changing the default print settings 64
- fitting your document to a selected paper size 62
- Linux 66
- Macintosh 65
- multiple pages on one sheet of paper
 - Macintosh 66
 - Windows 61
- poster 61

- printing a document
 - Windows 59
- printing to a file 65
- Printing a demo page 28
- printing a document
 - Linux 66
 - Macintosh 65
- printing a machine report 72
- problem, solve
 - printing quality 81
- problems
 - paper feeding problems 79
- R**
- regulatory information 11
- S**
- safety
 - information 7
 - symbols 7
- service contact numbers 94
- SetIP program 35, 47
- Smart Panel
 - font setting 51
 - general information 69
- specifications
 - general 90
 - print media 92
- supplies
 - available supplies 86
 - estimated toner cartridge life 74
 - ordering 86
 - replacing toner cartridge 86
- SyncThru Web Service
 - general information 68
- T**
- toner
 - distributing 75
- toner cartridge
 - estimated life 74
 - handling instructions 74
 - non-Samsung and refilled 74
 - replacing the cartridge 86
 - storing 73
- tray
 - adjusting the width and length 53
- turning on the machine 27

- U**
- understanding the control panel 26
 - cancel button 27
- USB cable
 - driver installation 30
- using help 61
- using overlay in windows 63
- using watermarks in windows 62
- W**
- watermark
 - create 62
 - delete 63
 - edit 63
 - print 62
- Windows
 - common Windows problems 84
 - driver installation for network connected 37
 - printing 59
 - sharing a machine locally 33
 - system requirements 29
 - using SetIP 35, 47
- wireless
 - WPS button 41
- wireless network
 - network cable 46
 - USB cable 41
 - wps
 - PIN 41