

2A, 0.25V Feedback Voltage Step-Down Switching Regulators for LED Driver

❖ GENERAL DESCRIPTION

AX2002/A consists of step-down switching regulator with PWM control. These device include a reference voltage source, oscillation circuit, error amplifier, internal PMOS and etc.

AX2002/A provides low-ripple power, high efficiency, and excellent transient characteristics. The PWM control circuit is able to the duty ratio linearly from 0 up to 100%. An enable function, an over current protect function and short circuit protect function are built inside, and when OCP or SCP happens, the operation frequency will be reduced. Also, an internal compensation block is built in to minimum external component count.

With the addition of an internal P-channel Power MOS, a coil, capacitors, and a diode connected externally, these ICs can function as step-down switching regulators. They serve as ideal power supply units for portable devices when coupled with the SOP-8L package, providing such outstanding features as low current consumption. Since this converter can accommodate an input voltage up to 23V, it is also suitable for the operation via an AC adapter.

❖ FEATURES

- Input voltage : 3.6V to 23V
- Output voltage : 0.25V to Vcc
- LED Backlight and High Power LED Application
- Duty ratio : 0% to 100% PWM control
- Oscillation frequency :
 - AX2002 : 330KHz typ.
 - AX2002A : 500KHz typ.
- Enable/Disable function.
- Current Limit (CL), Thermal Shutdown and Short Circuit Protections (SCP).
- Built-in internal SW P-channel MOS.
- No output capacitor is stable.
- SOP-8L Pb-Free package.

❖ Absolute Maximum Ratings (at Ta=25°C)

Characteristics	Symbol	Rating	Unit
VCC Pin Voltage	V _{CC}	V _{SS} - 0.3 to V _{SS} + 25	V
Feedback Pin Voltage	V _{FB}	V _{SS} - 0.3 to V _{CC}	V
ON/OFF Pin Voltage	V _{EN}	V _{SS} - 0.3 to V _{CC} + 0.3	V
Switch Pin Voltage	V _{SW}	V _{SS} - 0.3 to V _{CC} + 0.3	V
Power Dissipation	PD	Internally limited	mW
Storage Temperature Range	T _{ST}	-40 to +150	°C
Operating Temperature Range	T _{OP}	-40 to +125	°C
Operating Supply Voltage	V _{OP}	+3.6 to +23	V
Thermal Resistance from Junction to case	θ _{JC}	25	°C/W
Thermal Resistance from Junction to ambient	θ _{JA}	70	°C/W

Note : θ_{JA} is measured with the PCB copper area(need connect to SW pins) of approximately 1 in²(Multi-layer).

❖ Electrical Characteristics (VIN = 12V, Ta=25°C, unless otherwise specified)

Characteristics	Symbol	Conditions	Min	Typ	Max	Units	
Feedback Voltage	V _{FB}	I _{OUT} =0.2A	0.24	0.25	0.26	V	
Quiescent Current	I _{CCQ}	V _{FB} =1.2V force driver off		3	5	mA	
Feedback Bias Current	I _{FB}	I _{OUT} =0.1A	-	0.1	0.5	uA	
Shutdown Supply Current	I _{SD}	V _{EN} =0V	-	2	10	uA	
Switch Current	I _{SW}		2.5	-	-	A	
Line Regulation	ΔV _{OUT} /V _{OUT}	V _{CC} = 5V~23V, I _{OUT} =0.2A	-	1	2	%	
Load Regulation	ΔV _{OUT} /V _{OUT}	I _{OUT} = 0.1 to 2A	-	0.2	0.5	%	
Oscillation Frequency	F _{OSC}	AX2002	260	330	400	KHz	
		AX2002A	400	500	600	KHz	
EN Pin Logic input threshold voltage	V _{SH}	High (regulator ON)	2.0	-	-	V	
	V _{SL}	Low (regulator OFF)	-	-	0.8		
EN Pin Input Current	I _{SH}	V _{EN} =2.5V (ON)	-	20	-	uA	
	I _{SL}	V _{EN} =0.3V (OFF)	-	-10	-	uA	
Internal MOSFET R _{DS(ON)}	R _{DS(ON)}	V _{CC} =5V, V _{FB} =0V	-	100	140	mΩ	
		V _{CC} =12V, V _{FB} =0V	-	70	100		
Efficiency	EFFI	V _{OUT} = 5V	I _{OUT} = 1A	-	91	-	%
			I _{OUT} = 2A	-	91	-	
Thermal shutdown Temp	TSD		-	140	-	°C	

(2) Add 4.7uF Output Capacitor

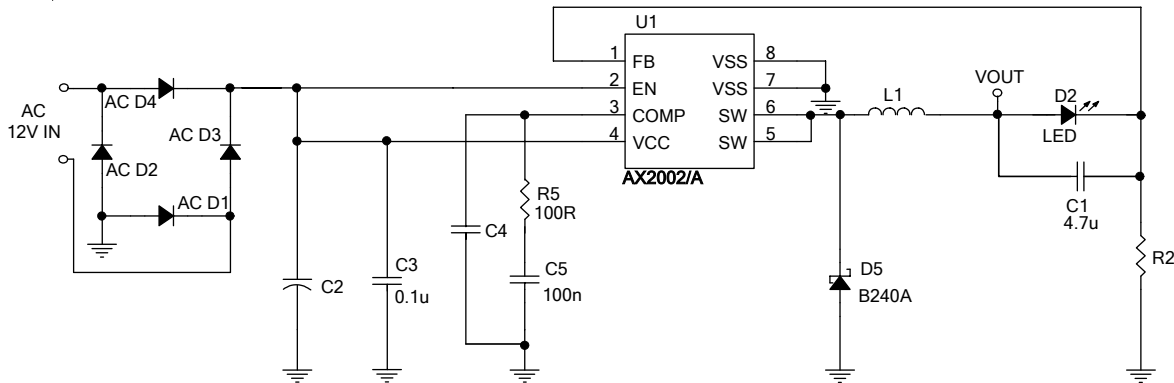

Part No.	I_{LED}	R2		C2	C4	L1
AX2002	350mA	0.715Ω	87.5mW	100uF	10nF	33uH
	750mA	0.333Ω	189mW	220uF		
	1000mA	0.250Ω	250mW	330uF		
AX2002A	350mA	0.715Ω	87.5mW	100uF	3.3nF	22uH
	750mA	0.333Ω	189mW	220uF		
	1000mA	0.250Ω	250mW	330uF		

❖ Function Descriptions

PWM Control

The AX2002/A consists of DC/DC converters that employ a pulse-width modulation (PWM) system. In converters of the AX2002/A, the pulse width varies in a range from 0 to 100%, according to the load current. The ripple voltage produced by the switching can easily be removed through a filter because the switching frequency remains constant. Therefore, these converters provide a low-ripple power over broad ranges of input voltage and load current.

Setting the I_{LED} Current

Application circuit item shows the basic application circuit with AX2002/A adjustable output version. The external resistor sets the LED output current according to the following equation:

$$I_{LED} = \left(\frac{0.25V}{R2} \right)$$

Table 1 Resistor select for LED output current setting

I _{LED}	R2	
350mA	0.715Ω	87.5mW
750mA	0.333Ω	189mW
1000mA	0.250Ω	250mW

RDS(ON) Current Limiting

The current limit threshold is setting by the internal circuit.

Compensation

Please refer the table of application circuit. For DC input, the option circuit for compensation is connecting R4 and a 4148 diode to Vout. In order to protect short circuit and thermal shutdown release for LED.

PCB layout guide

If you need low Tc & Tj or large PD (Power Dissipation), the dual SW pins (5&6) on the SOP-8L package are internally connected to die pad, The PCB layout should allow for maximum possible copper area at the SW pins of the AX2002/A.

❖ Typical Characteristics

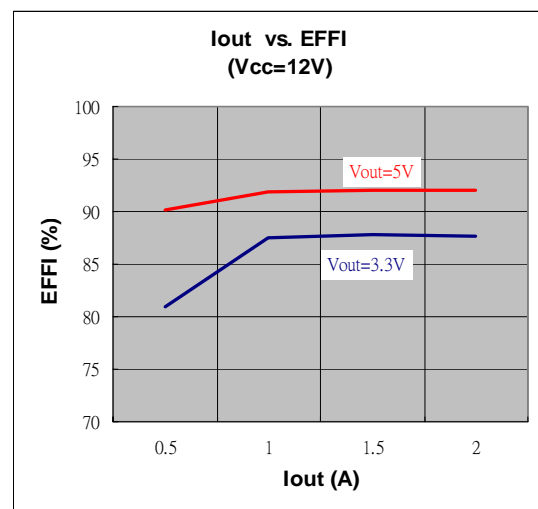
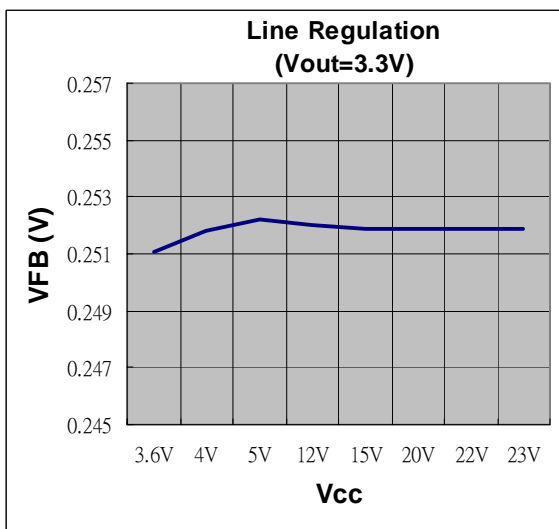
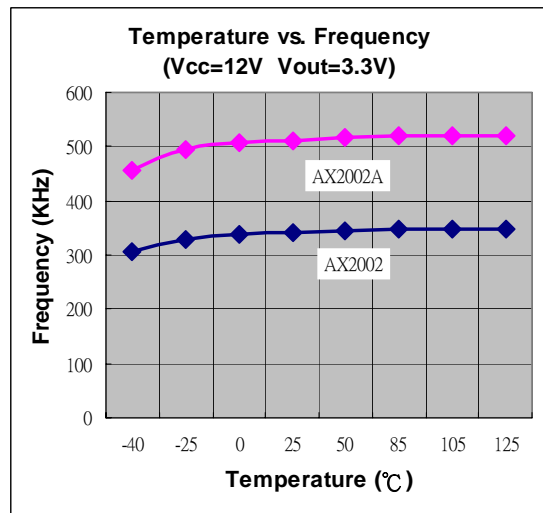
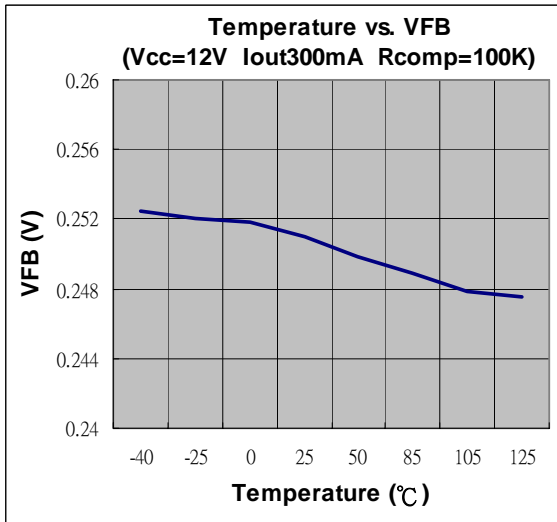
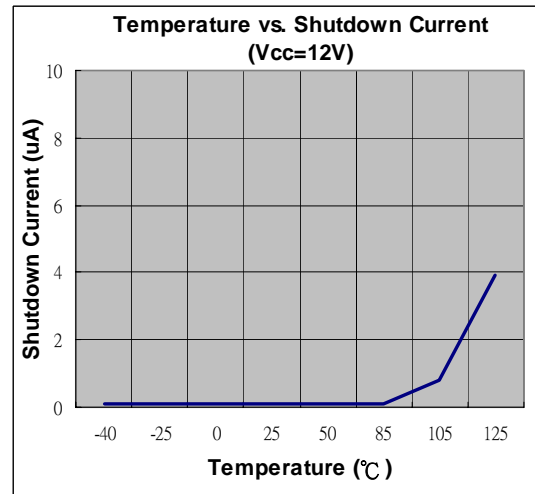
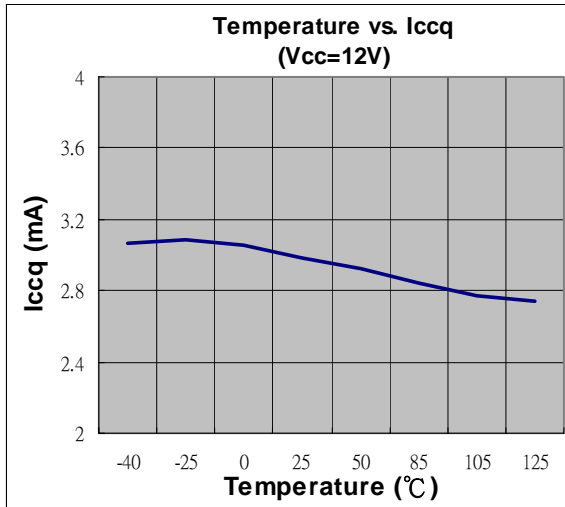

❖ Package Outlines

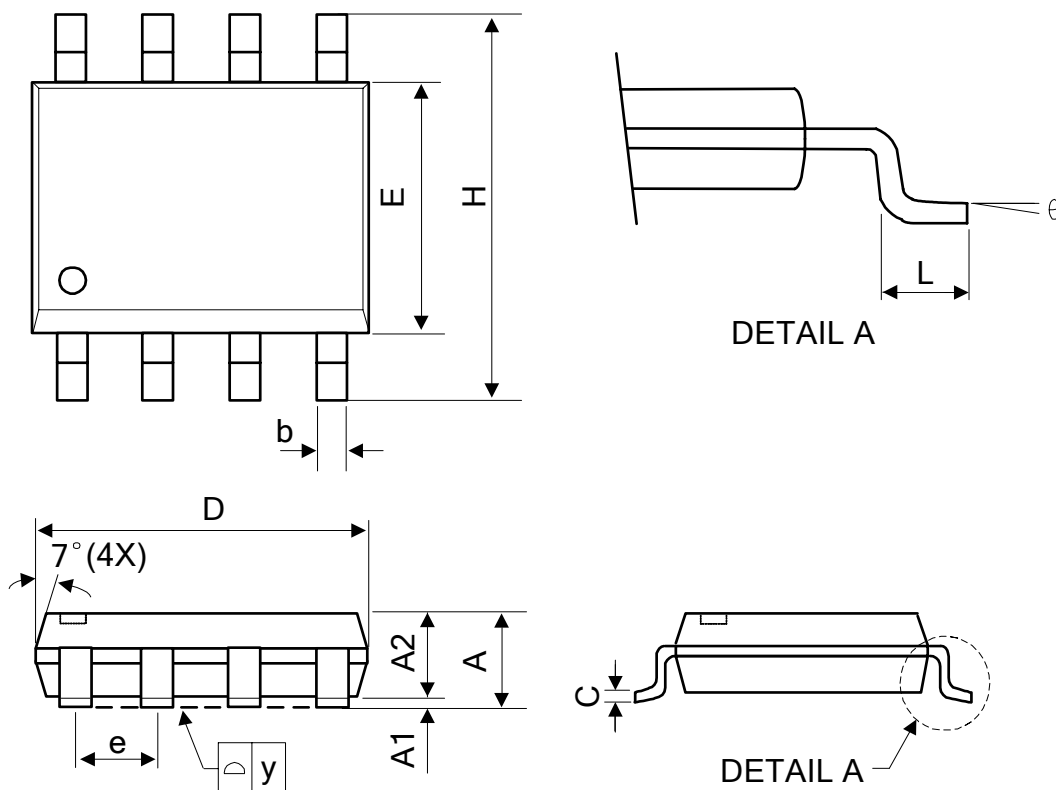

Symbol	Dimensions In Millimeters			Dimensions In Inches		
	Min.	Nom.	Max.	Min.	Nom.	Max.
A	1.40	1.60	1.75	0.055	0.063	0.069
A1	0.10	-	0.25	0.040	-	0.100
A2	1.30	1.45	1.50	0.051	0.057	0.059
C	0.19	0.20	0.25	0.0075	0.008	0.010
D	4.80	4.90	5.00	0.189	0.193	0.197
E	3.80	3.90	4.00	0.150	0.154	0.157
H	5.79	5.99	6.20	0.228	0.236	0.244
L	0.38	0.71	1.27	0.015	0.028	0.050
b	0.33	0.41	0.51	0.013	0.016	0.020
e	1.27 TYP			0.050 TYP		
y	-	-	0.10	-	-	0.004
θ	0°	-	8°	0°	-	8°