

6.92cm Diagonal Reflective Color LCD Module

Description

The ACX705AKM is a 6.92cm diagonal active matrix reflective color TFT-LCD module with a front light unit and a driving board. This module provides low power consumption which is realized by built-in 3-bit digital interface circuitry.

Features

- Number of dots: 240 × RGB × 160
- Dot size: 80μm × 240μm
- High reflectivity: (25% typ.)
- High contrast ratio: (13:1 typ. at the condition of turning off the front light)
- Number of colors: 512
- Low power consumption (47mW typ.) with a driving board composed of a LCD controller IC, a reference driver IC and a DC-DC convertor
- Built-in 3-bit digital interface circuitry
- Compact size
- Thin and bright front light unit

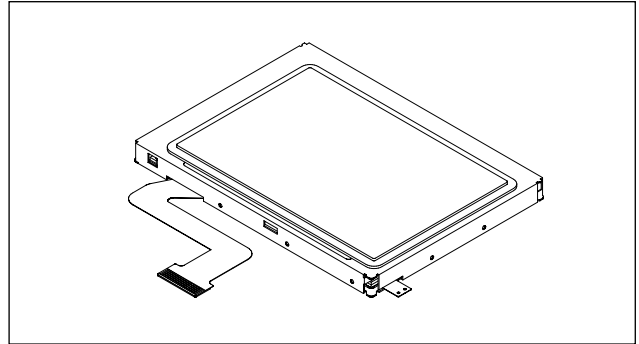

Element Structure

- Active matrix TFT-LCD panel with built-in peripheral driving circuitry using low temperature polycrystalline silicon transistors
- Number of dots
 - Total number of dots: $242 \times 3 \text{ (H)} \times 162 \text{ (V)} = 117,612$
 - Number of active dots: $240 \times 3 \text{ (H)} \times 160 \text{ (V)} = 115,200$
- Dimensions
 - Module dimensions: 71.4mm × 52.0mm × 4.8mm (t) (parts area 6.5mm (t) max.)
 - Effective display dimensions: 57.6mm (H) × 38.4mm (V)

Applications

PDA, etc.

Sony reserves the right to change products and specifications without prior notice. This information does not convey any license by any implication or otherwise under any patents or other right. Application circuits shown, if any, are typical examples illustrating the operation of the devices. Sony cannot assume responsibility for any problems arising out of the use of these circuits.

Absolute Maximum Ratings ($T_a = 25^\circ\text{C}$, $V_{ss} = 0\text{V}$)

• Supply voltage	V_{cc1}	$V_{ss} - 0.3$ to $+5.5$	V
	V_{cc2}	$V_{ss} - 0.3$ to $+5.5$	V
• Input voltage	V_i	$V_{ss} - 0.3$ to $V_{cc2} + 0.3$	V
• Storage temperature	T_{stg}	-30 to $+70$	$^\circ\text{C}$
• LED current	I_{led}	(as below)	

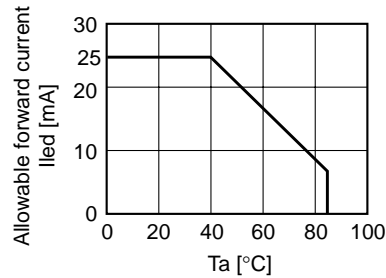

Recommended Operating Conditions

• Supply voltage	V_{cc1}	3.50 to 4.20	V
	V_{cc2}	2.55 to 3.15	V
• Operating temperature	T_{opr}	-10 to $+60$	$^\circ\text{C}$

Pin Location of Panel Block

The FPC pin assignment is described in on page 5. The location of Pin 1 is shown below.

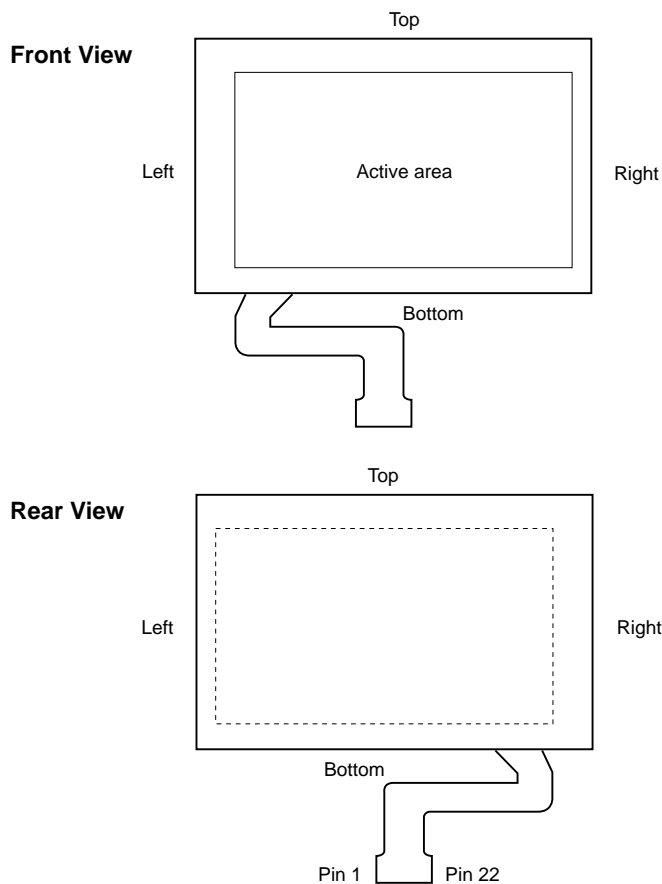

Module Configuration

This module is composed of a reflective color TFT-LCD panel, a front light unit and a driving board as shown in the figure below.

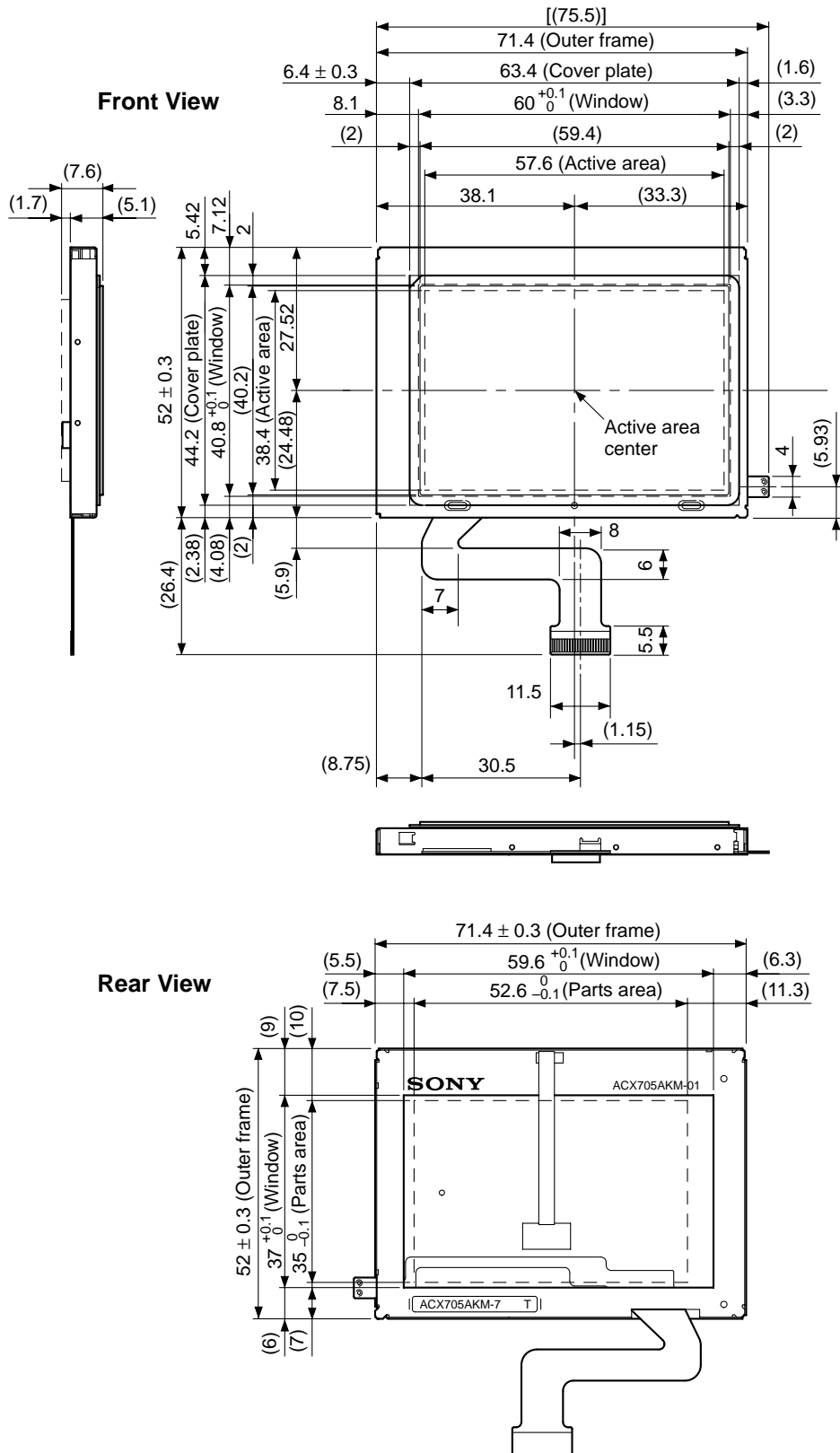

Block Diagram

The block diagram of this LCD module is shown below.

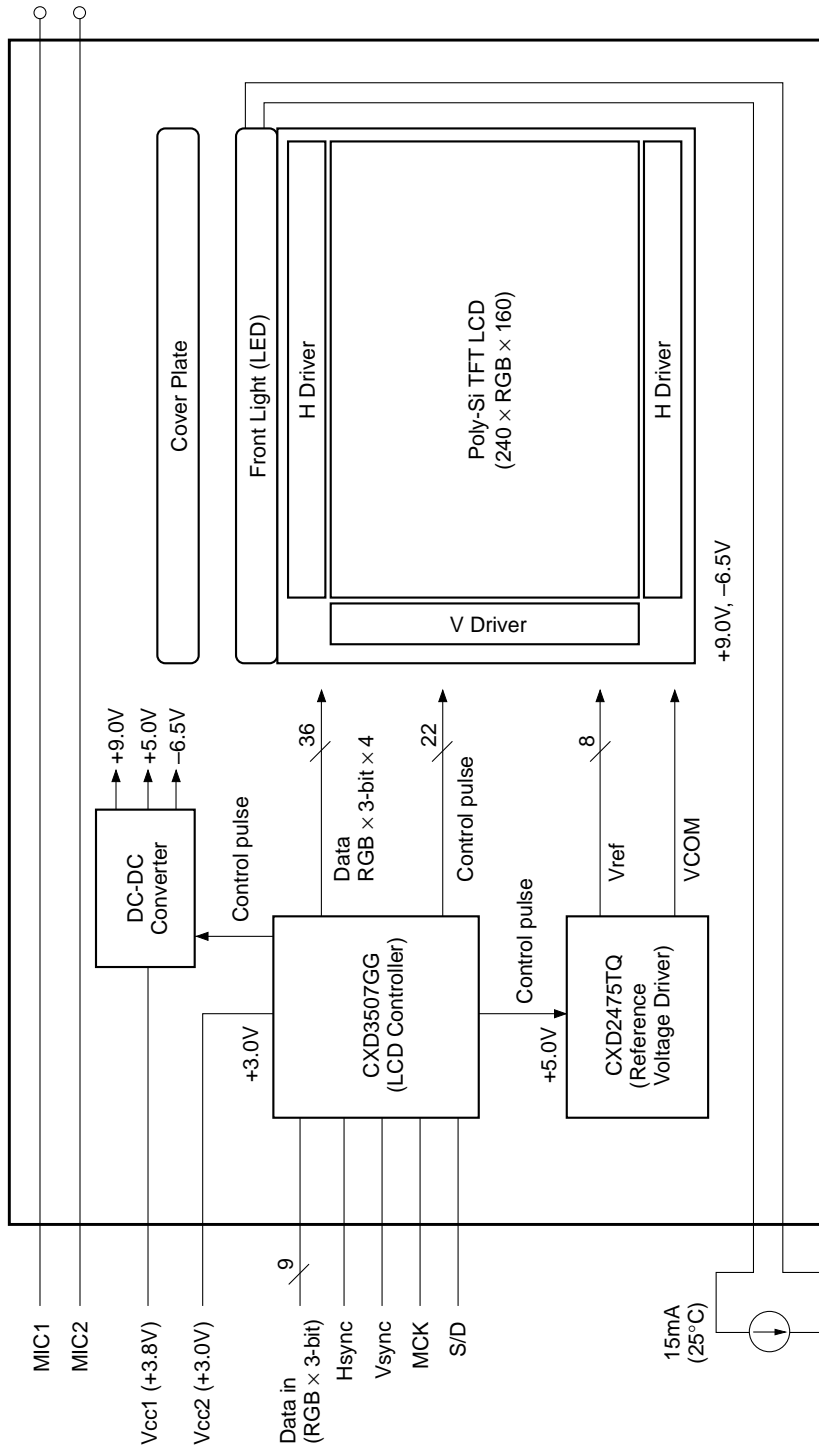

Pin Description

Pin No.	Symbol	Description
1	MIC1	
2	MIC2	
3	Vcc1	+3.8V power supply
4	Vcc1	+3.8V power supply
5	GND	Ground
6	GND	Ground
7	R0	Red data input (LSB)
8	R1	Red data input
9	R2	Red data input (MSB)
10	G0	Green data input (LSB)
11	G1	Green data input
12	G2	Green data input (MSB)
13	B0	Blue data input (LSB)
14	B1	Blue data input
15	B2	Blue data input (MSB)
16	Hsync	Hsync input
17	Vsync	Vsync input
18	S/D	Shut down
19	MCK	Master clock (4.2MHz)
20	Vcc2	+3.0V power supply
21	LED V _{DD}	LED V _{DD}
22	LED GND	LED GND

S/D

There are input for power up/down sequence.

Power Up Sequence

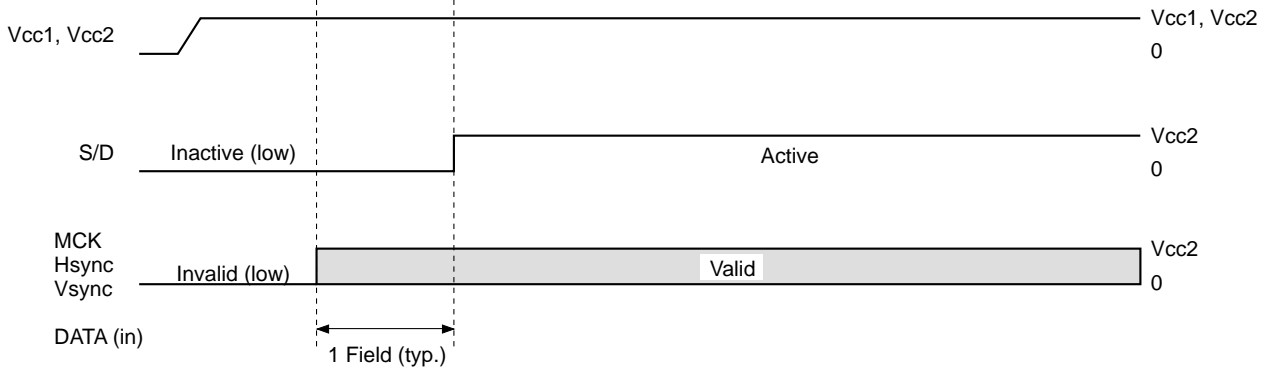

Power Down Sequence

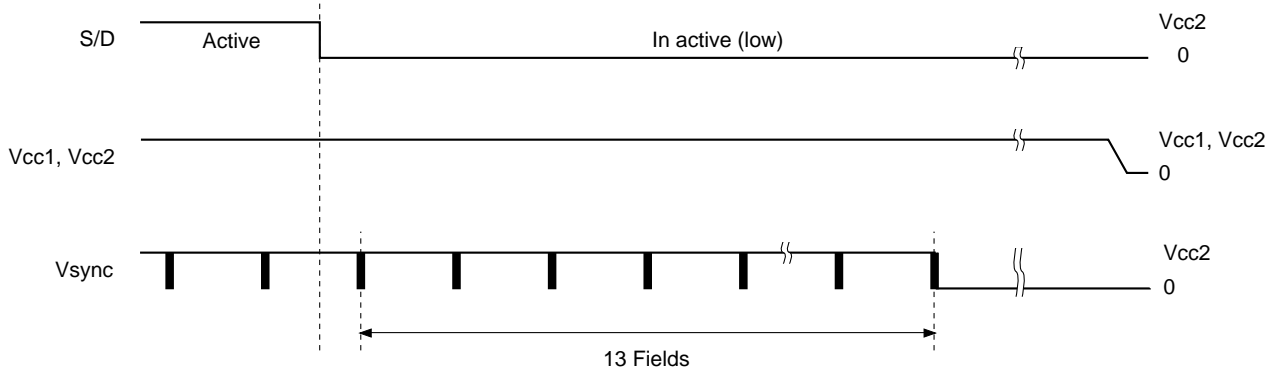

Electrical Characteristics

Item	Symbol	Min.	Typ.	Max.	Unit	Pins	
Supply voltage	V _{CC1}	3.50	3.80	4.20	V	V _{CC1}	
	V _{CC2}	2.55	3.00	3.15	V	V _{CC2}	
Ripple voltage	V _{RF}	—	—	100	mV	V _{CC1}	
Input voltage 1	V _{H1}	2.0	—	—	V	MCK (LVTTL level input)	
	V _{L1}	—	—	0.7	V		
Input voltage 2	V _{t+}	—	—	2.2	V	All input pins excluding MCK (LVTTL level Schmitt trigger input)	
	V _{t-}	0.5	—	—	V		
	V _{t+} – V _{t-}	0.2	—	—	V		
Supply current	I _{LED}	—	15	—	mA	LED V _{DD}	
Input current 1	V _I = V _{CC2}	I _{H1}	—	—	1.0	μA	All input pins
	V _I = 0V	I _{L1}	—	—	1.0	μA	
Current consumption	I _{CC1}	—	11.0	17.0	mA	V _{CC1}	
	I _{CC2}	—	1.6	4.0	mA	V _{CC2}	
Total power consumption	P	—	47	77	mW		
Standby current	I _{CC1s}	—	0.1	10	μA		
	I _{CC2s}	—	40	200	μA		
MCK frequency	f _{MCK}	—	3.26	4.20	MHz		
Horizontal frequency	f _h	—	12.0	15.4	kHz		
Vertical frequency	f _v	—	60.0	77.2	Hz		
Data input pin capacitance	C _{data}	—	—	20	pF	R0 to R2, G0 to G2, B0 to B2	
Hsync input pin capacitance	C _{hsde}	—	—	20	pF	Hsync	
Vsync input pin capacitance	C _{vs}	—	—	20	pF	Vsync	
MCK input pin capacitance	C _{mck}	—	—	20	pF	MCK	
S/D input pin capacitance	C _{sd}	—	—	20	pF	S/D	

* 8-pixel × 8-pixel Black and White checker pattern

Operating Conditions

Item	Symbol	Min.	Typ.	Max.	Unit
Master clock period	tclk	1	—	—	tclk
MCK width high	tch	—	0.5	—	tclk
MCK width low	tcl	—	0.5	—	tclk
Data setup to MCK falling edge	tds	10	—	—	ns
Data hold from MCK falling edge	tdh	15	—	—	ns
Hsync setup to MCK falling edge	thss	10	—	—	ns
Hsync pulse width low	thsw	9	—	16	tclk
Vsync falling edge to Hsync falling edge phase difference	tvhde	254	—	269	tclk
Vsync pulse width low	tvsw	2	—	20	line

Operating Condition of Front Light

Item	Symbol	Min.	Typ.	Max.	Unit
LED current	lled	—	15	—	mA

Lamp Life

The lamp life shall be greater than 50 hours. The operating lamp life is defined as having ended when the illumination of light has reached 50% of the initial value.

Horizontal Timing Chart

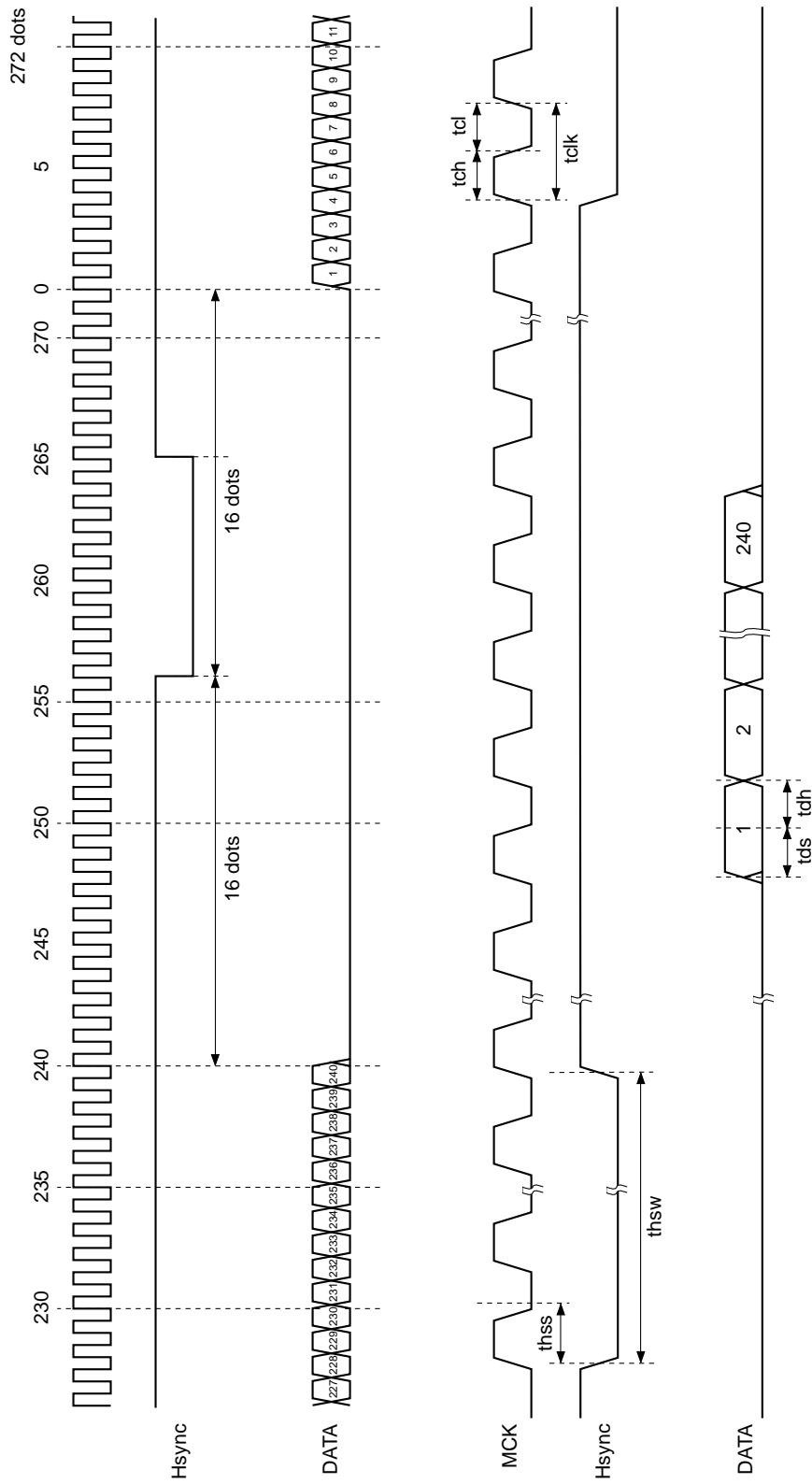

Vertical Timing Chart

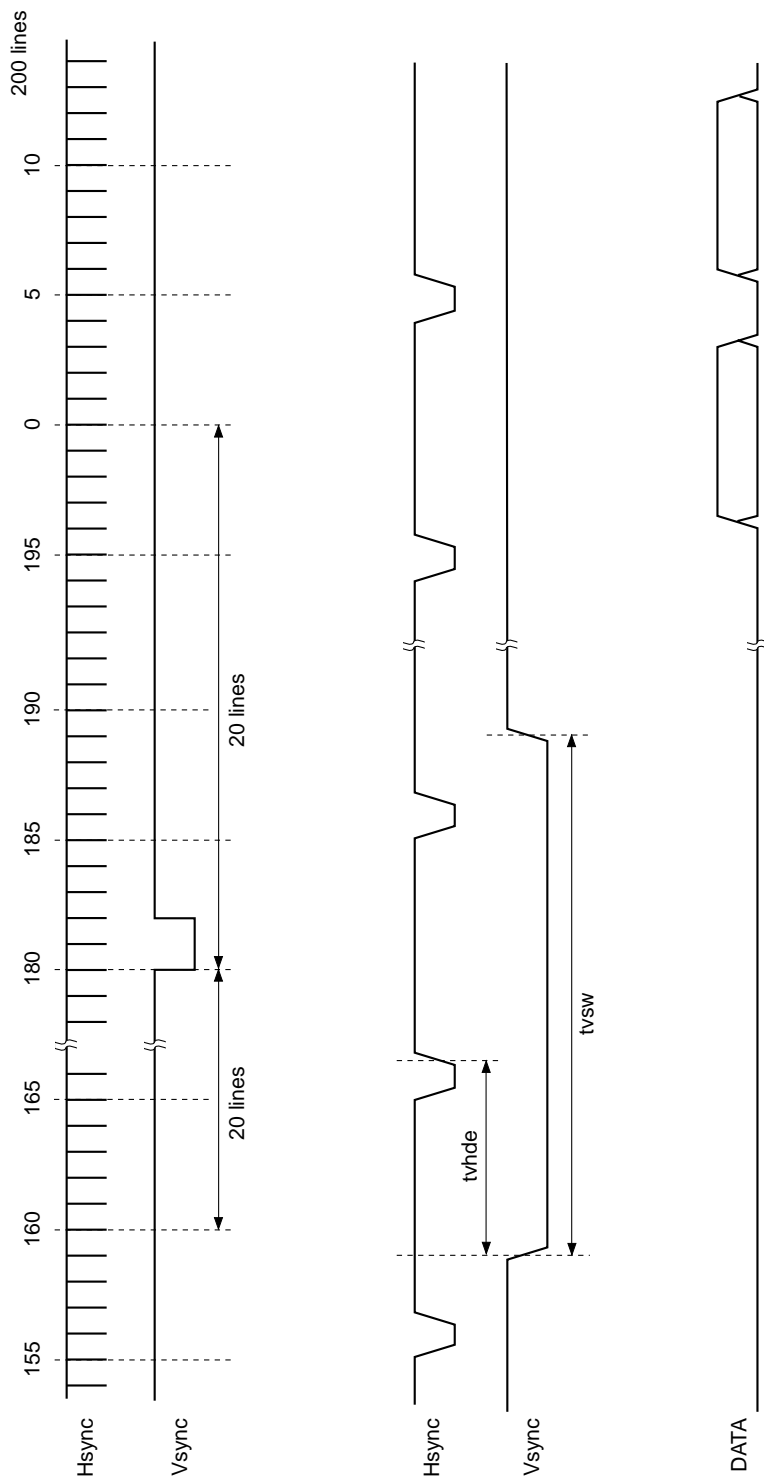

Color Combination Table

	Color	Data signal									
		Gray scale	R0	R1	R2	G0	G1	G2	B0	B1	B2
Standard color	Black	—	0	0	0	0	0	0	0	0	0
	Blue	—	0	0	0	0	0	0	1	1	1
	Green	—	0	0	0	1	1	1	0	0	0
	Cyan	—	0	0	0	1	1	1	1	1	1
	Red	—	1	1	1	0	0	0	0	0	0
	Magenta	—	1	1	1	0	0	0	1	1	1
	Yellow	—	1	1	1	1	1	1	0	0	0
	White	—	1	1	1	1	1	1	1	1	1
Red	Black	0	0	0	0	0	0	0	0	0	0
	↑	1	1	0	0	0	0	0	0	0	0
	Dark	2	0	1	0	0	0	0	0	0	0
	↑	3	1	1	0	0	0	0	0	0	0
	↓	4	0	0	1	0	0	0	0	0	0
	Bright	5	1	0	1	0	0	0	0	0	0
	↓	6	0	1	1	0	0	0	0	0	0
Red	7	1	1	1	0	0	0	0	0	0	
Green	Black	0	0	0	0	0	0	0	0	0	0
	↑	1	0	0	0	1	0	0	0	0	0
	Dark	2	0	0	0	0	1	0	0	0	0
	↑	3	0	0	0	1	1	0	0	0	0
	↓	4	0	0	0	0	0	1	0	0	0
	Bright	5	0	0	0	1	0	1	0	0	0
	↓	6	0	0	0	0	1	1	0	0	0
Green	7	0	0	0	1	1	1	0	0	0	
Blue	Black	0	0	0	0	0	0	0	0	0	0
	↑	1	0	0	0	0	0	0	1	0	0
	Dark	2	0	0	0	0	0	0	0	1	0
	↑	3	0	0	0	0	0	0	1	1	0
	↓	4	0	0	0	0	0	0	0	0	1
	Bright	5	0	0	0	0	0	0	1	0	1
	↓	6	0	0	0	0	0	0	0	1	1
Blue	7	0	0	0	0	0	0	1	1	1	

Gray Scale

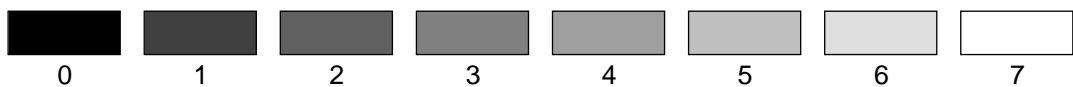

Color Coding

The color filters are coded in vertical stripe arrangement.
 The shaded area is used for the dark border around the display.

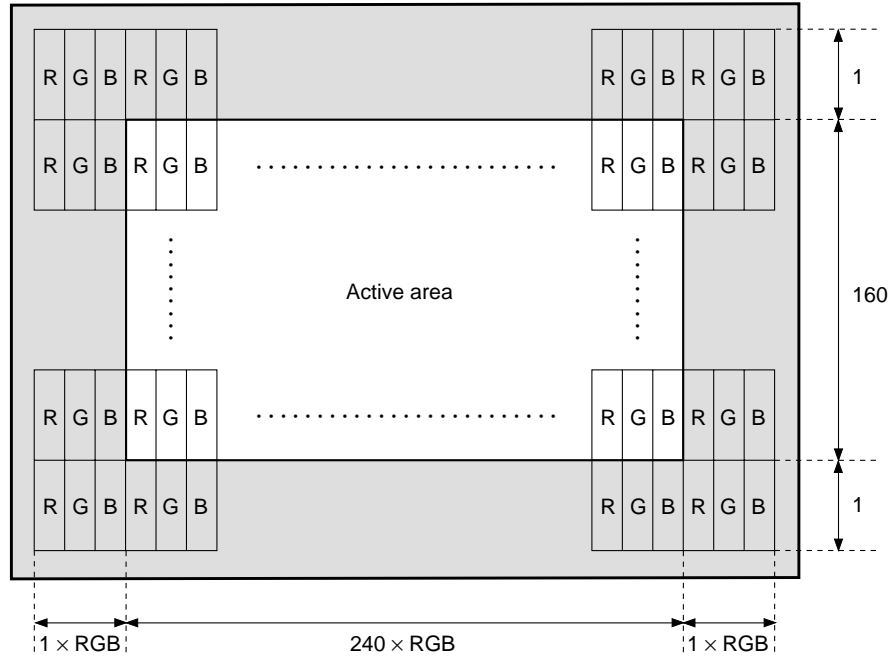

Front view

Scanning Direction

The scanning direction for the horizontal period and for the vertical period are A and B respectively as shown below.

These scanning directions are from a front view.

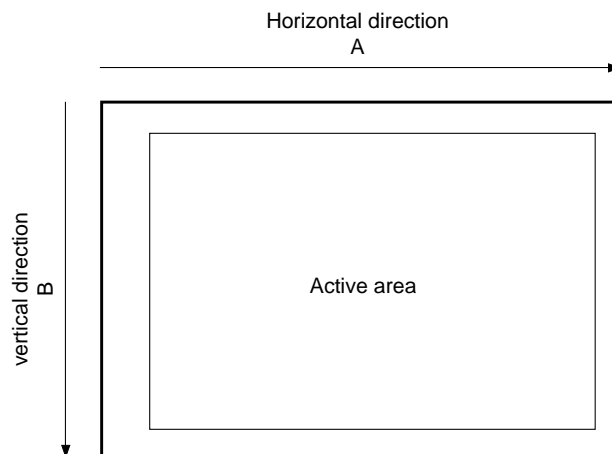

Front view

Electro-optical Characteristics

Ta = 25°C, With front light turning off

Item	Symbol	Min.	Typ.	Max.	Unit	Notes	
Reflectivity	R	20	25	—	%	1	
Contrast ratio	CR	10	13	—		2	
White chromaticity	x	xfloff	0.28	0.30	0.32	CIE	3
	y	yfloff	0.29	0.31	0.33	CIE	
Response time	rise	Tr	—	5	40	ms	4
	fall	Tf	—	10	40	ms	
Viewing angle	Top-Bottom	VAtb	90	100	—	degree (°)	5
	Left-Right	VAlr	100	120	—	degree (°)	

Ta = 25°C, With front light turning on (Iled = 15mA)

Item	Symbol	Min.	Typ.	Max.	Unit	Notes	
Luminance	Lcfl	3.3	5	—	cd/m ²	6	
Luminance uniformity	Flunif	—	1.3	1.7		7	
White chromaticity	x	xflon	0.27	0.32	0.37	CIE	3
	y	yflon	0.27	0.32	0.37	CIE	

Notes:

1. Reflectivity (R)

In the Measurement system-1 (see Fig. 1 (a), (b)), calculate the reflectance factor by using the formula (1).

$$R = R(\text{White}) = \frac{\text{Output from the "White" displayed panel}}{\text{Output from the reflectance standard}} \times \text{reflectance factor of the reflectance standard} \dots(1)$$

2. Contrast ratio with front light turned off (CR)

In the Measurement system-1 (see Fig. 1 (a), (b)), measure the reflectance factor of "White" and "Black" respectively and calculate by using the formula (2).

$$CR = \frac{R(\text{White})}{R(\text{Black})} \dots(2)$$

3. White chromaticity

In the Measurement system-2 (see Fig. 2), measure the white chromaticity. The illumination source and viewing area are D65 and 2° respectively.

4. Response time

In the Measurement system-3 (see Fig. 3), measure the electro-optical response time.

5. Viewing angle

In the Measurement system-1 (see Fig. 1 (c)), viewing area is defined by the area which makes the $CR \geq 2$.

6. Luminance

In the Measurement system-4 (see Fig. 4), measure the luminance and calculate using the following formula (3).

$$L_{cfl} = (\text{Luminance (1)} + \text{Luminance (3)} + \text{Luminance (5)} + \text{Luminance (7)} + \text{Luminance (9)})/5 \dots(3)$$

7. Luminance uniformity

In the Measurement system-4 (see Fig. 4), measure the luminance and calculate using the following formula (4).

$$Fl_{unif} = \text{Luminance (maximum spot)}/\text{Luminance (minimum spot)} \dots(4)$$

Basic Measurement Conditions

(1) Driving voltage

Typical condition

(2) Measurement temperature

+25°C unless otherwise specified.

(3) Measurement point

One point on the center of the panel unless otherwise specified.

(4) Light source and viewing area

D65 and 2°

(5) Display "White": All R, G and B signal data are high (signal amplitude across the liquid crystal: $\pm 1.0V$).

Display "Black": All R, G and B signal data are low (signal amplitude across the liquid crystal: $\pm 4.5V$).

Front light is turned off unless otherwise specified.

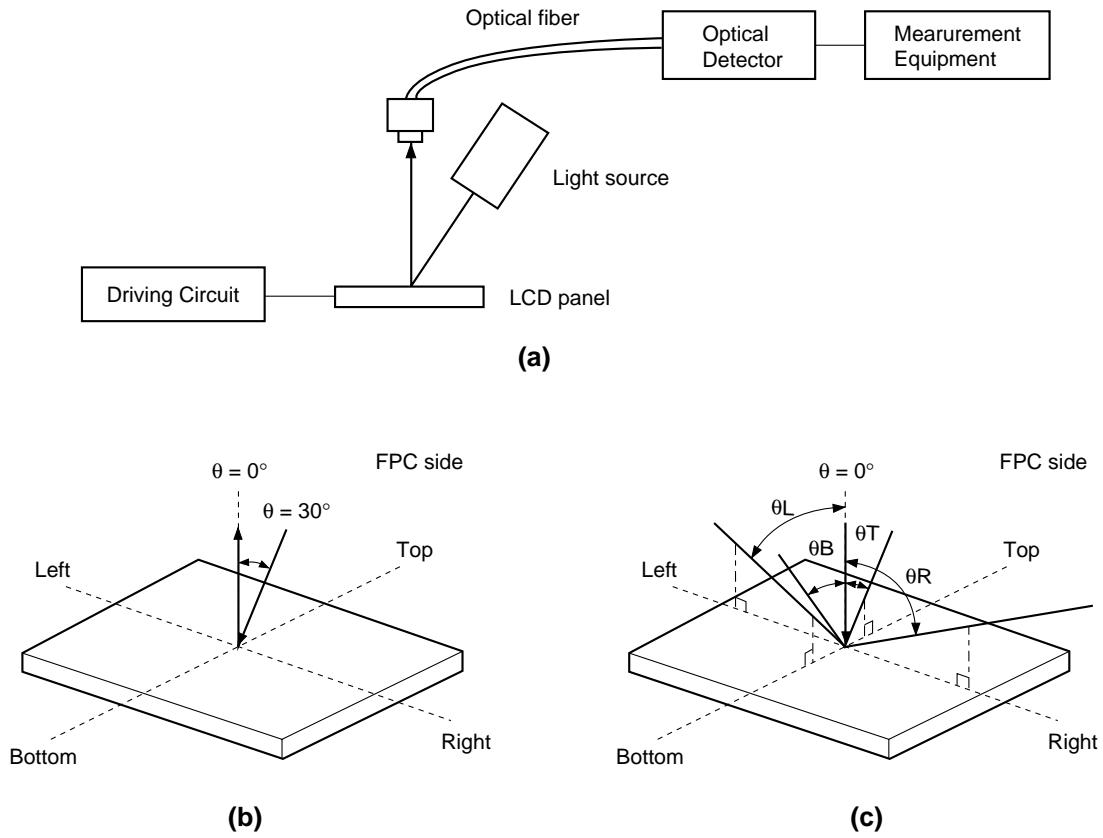

Fig. 1. Measurement system-1

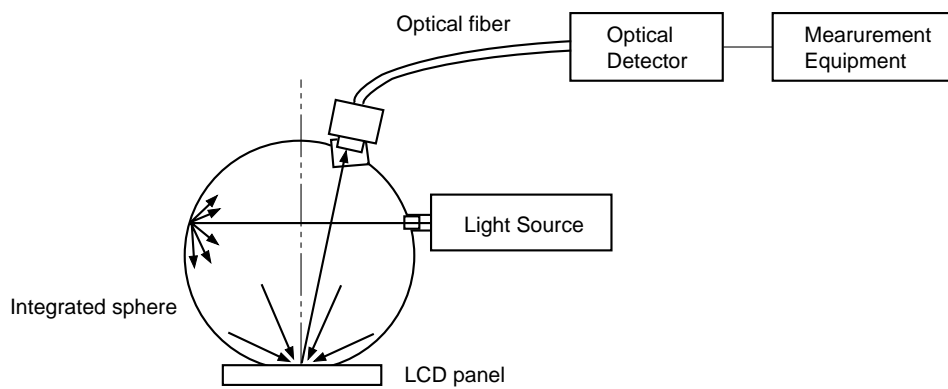

Fig. 2. Measurement system-2

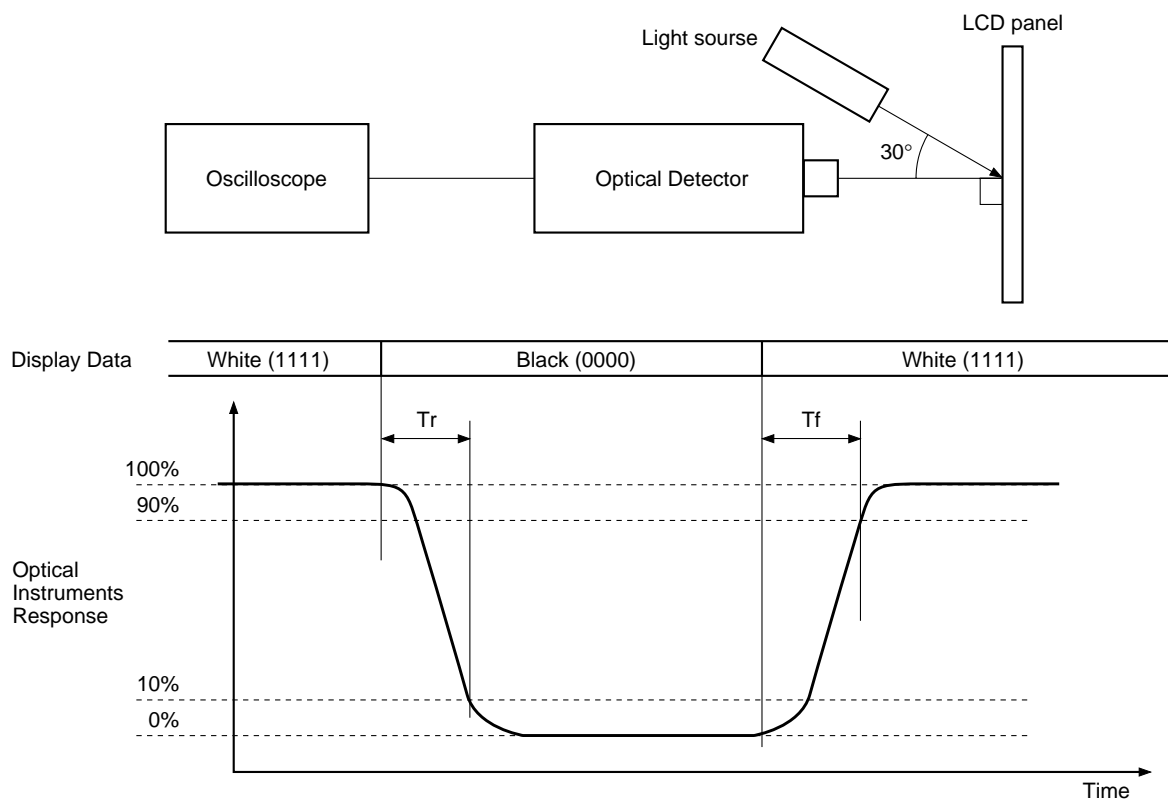
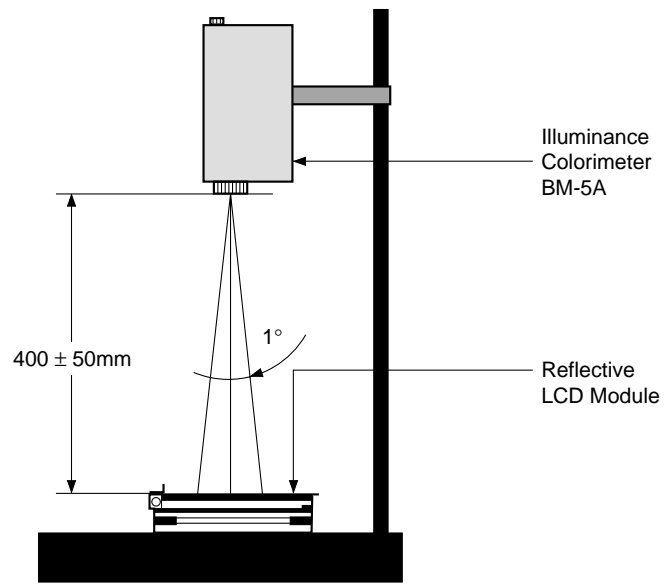
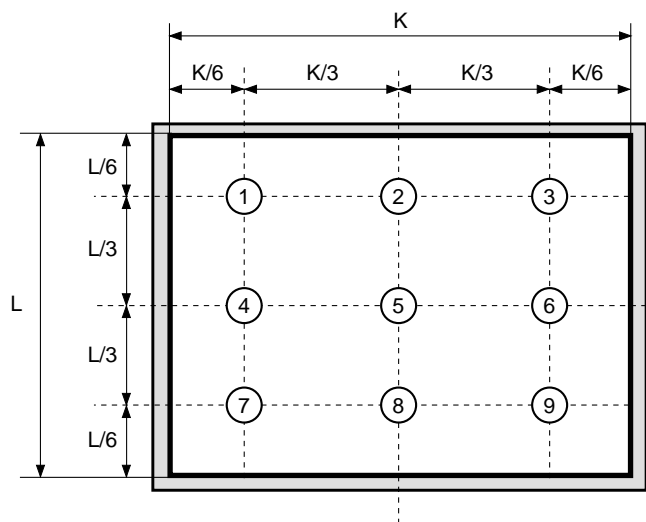

Fig. 3. Measurement system-3



(a) The apparatus for luminance measurement



(b) The spot locations for luminance measurement

Fig. 4. Measurement system-4

Image Persistence

Display a completely white screen for 20 minutes and continuously display the test pattern shown below for a minimum of two hours. Then display a completely white screen. A visible image of the box pattern shall not persist more than two seconds viewed through 2% ND filter. Pattern is black box 80 pixels wide and 120 pixels in length at minimum luminance, centered horizontally and vertically in the active area. The remainder of the screen is white.



Cross Modulation

Cross modulation (cross talk) shall be inspected with following test pattern with 2% ND filter. Pattern is black box 80 pixels wide and 120 pixels in length at minimum luminance, centered horizontally and vertically in the active area. The remainder of the screen is 50% gray.

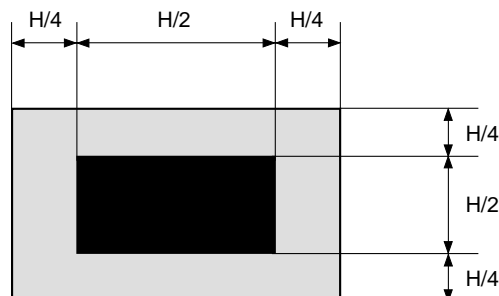

There shall be no visible difference of luminance around the black box through 2% ND filter.

Notes on Handling

(1) Static charge prevention

Be sure to take the following protective measures. TFT-LCD panels are easily damaged by static charges.

- a) Use non-chargeable gloves, or simply use bare hands.
- b) Use an earth-band when handling.
- c) Do not touch any electrodes of a panel.
- d) Wear non-chargeable clothes and conductive shoes.
- e) Install grounded conductive mats on the working floor and working table.
- f) Keep panels away from any charged materials.
- g) Use ionized air to discharge the panels.

(2) Protection from dust and dirt

- a) Operate in a clean environment.
- b) Do not touch the front light surface. The surface is easily scratched.
- c) Use ionized air to blow dust off the panel.

(3) Others

- a) Do not twist or bend the flexible PC board especially at the connecting region because the board is easily deformed.
- b) Do not drop the module.
- c) Do not twist or bend the module.
- d) Keep the module away from heat sources.
- e) Do not dampen the module with water or other solvents.
- f) Avoid storage or using the module at high temperature or high humidity, as this may result in damage.

Package Outline

Unit: mm

