

IR Sensor Module for Remote Control Systems

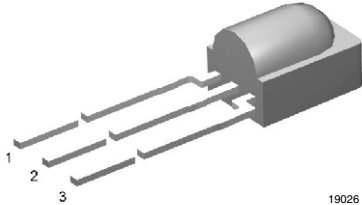

MECHANICAL DATA

Pinning:

1 = Carrier OUT, 2 = GND, 3 = V_S

FEATURES

- Photo detector and preamplifier in one package
- AC coupled response from 20 kHz to 455 kHz, all data formats
- Improved shielding against electrical field disturbance
- TTL and CMOS compatibility
- Output active low
- Supply voltage: 2.7 V to 5.5 V
- Carrier out signal for code learning functions
- Compliant to RoHS directive 2002/95/EC and in accordance to WEEE 2002/96/EC



RoHS
COMPLIANT

DESCRIPTION

The TSOP98200 is a miniaturized sensor for receiving the modulated signal of infrared remote control systems. A PIN diode and preamplifier are assembled on a lead frame, the epoxy package is designed as an IR filter. The modulated output signal, carrier out, can be used for code learning applications.

This component has not been qualified according to automotive specifications.

PARTS TABLE

CARRIER FREQUENCY	CODE LEARNING APPLICATIONS
20 kHz to 455 kHz	TSOP98200

BLOCK DIAGRAM

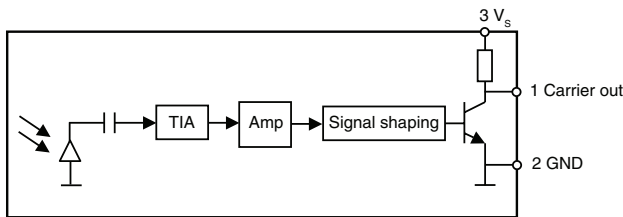

19746

APPLICATION CIRCUIT

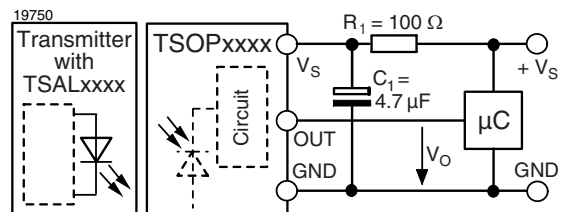

$R_1 + C_1$ recommended to suppress power supply disturbances.

ABSOLUTE MAXIMUM RATINGS (1)				
PARAMETER	TEST CONDITION	SYMBOL	VALUE	UNIT
Supply voltage (pin 3)		V_S	- 0.3 to + 5.5	V
Output voltage (pin 1)		V_O	- 0.3 to ($V_S + 0.3$)	V
Output current (pin 1)		I_O	10	mA
Junction temperature		T_J	100	°C
Storage temperature range		T_{stg}	- 25 to + 85	°C
Operating temperature range		T_{amb}	- 25 to + 85	°C
Soldering temperature	$t \leq 10$ s, 1 mm from case	T_{sd}	260	°C

Note

(1) $T_{amb} = 25$ °C, unless otherwise specified
 Stresses beyond those listed under “Absolute Maximum Ratings” may cause permanent damage to the device. This is a stress rating only and functional operation of the device at these or any other conditions beyond those indicated in the operational sections of this specification is not implied. Exposure to absolute maximum rating conditions for extended periods may affect the device reliability.

ELECTRICAL AND OPTICAL CHARACTERISTICS CARRIER OUT (1)						
PARAMETER	TEST CONDITION	SYMBOL	MIN.	TYP.	MAX.	UNIT
Supply current (pin 3)	$E_v = 0$	I_{SD}		0.6	0.8	mA
Supply voltage		V_S	2.7		5.5	V
Transmission distance	$E_v = 0$, test signal see fig. 1, IR diode TSAL6200, $I_F = 400$ mA	d		1		m
Output voltage low (pin 1)	$I_{OSL} = 0.5$ mA, test signal see fig. 1	V_{OSL}			250	mV
Minimum irradiance	$V_S = 3$ V, (20 kHz to 60 (2) kHz)	$E_{e \text{ min.}}$		0.3	0.5	W/m ²
Maximum irradiance	Test signal see fig. 1, (20 kHz to 60 (2) kHz)	$E_{e \text{ max.}}$	300	500		W/m ²
Directivity	Angle of half transmission distance	$\varphi_{1/2}$		± 45		deg
Carrier out rise time	$V_S = 3$ V, $C_L = 10$ pF	T_R		100		ns
Carrier out fall time	$V_S = 3$ V, $C_L = 10$ pF	T_F		10		ns
Output pulse width	$T_{PI} = 10$ μ s, $C_L = 10$ pF	T_{PO}	0.6	1.1	1.6	μ s

Note

(1) $T_{amb} = 25$ °C, unless otherwise specified, $V_S = 3$ V
 (2) These irradiance values are guaranteed to 60 kHz. The TSOP98200 will continue to function up to frequencies higher than 600 kHz, however the irradiance at frequencies above 60 kHz is dependent on the carrier frequency and the pulse pattern received.
 Typical $E_{e \text{ min.}} = 2$ W/m² at 455 kHz.

TYPICAL CHARACTERISTICS

$T_{amb} = 25$ °C, unless otherwise specified

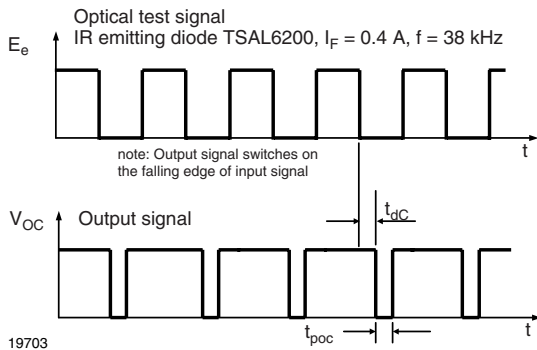

Fig. 1 - Carrier Output Pulse Diagram

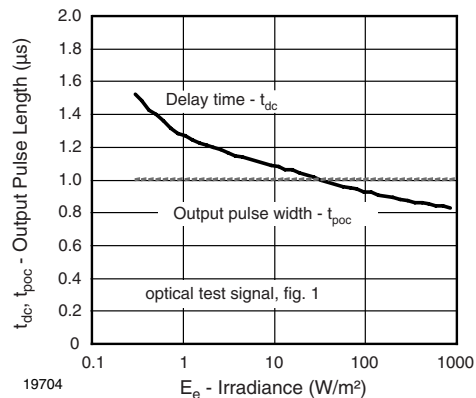

Fig. 2 - Carrier Output Function Diagram

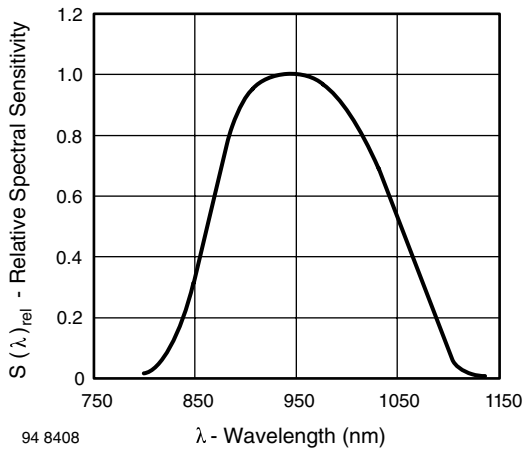

Fig. 3 - Relative Spectral Sensitivity vs. Wavelength

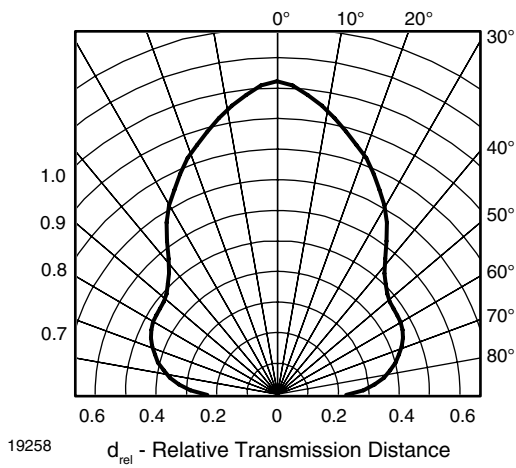

Fig. 4 - Horizontal Directivity

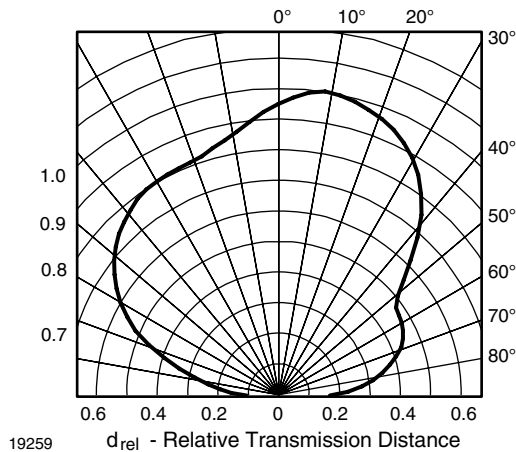
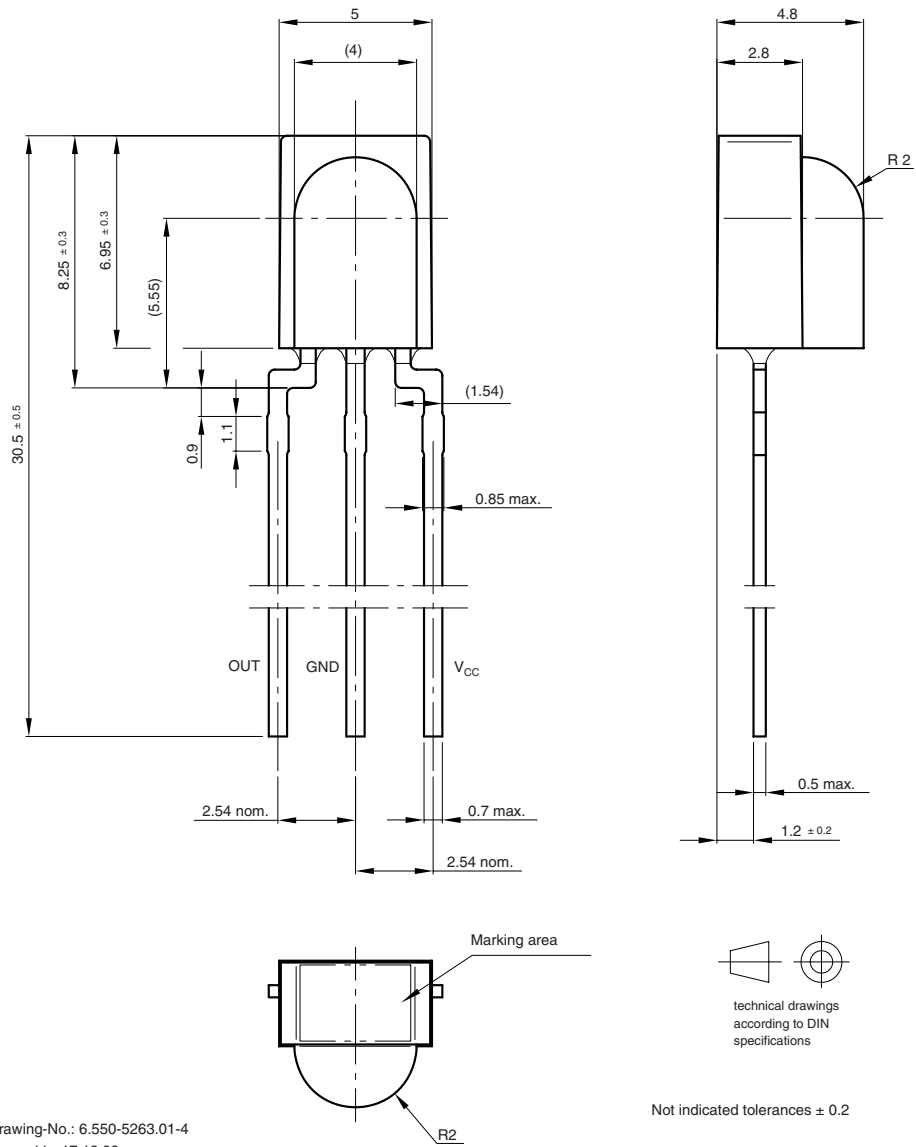

Fig. 5 - Vertical Directivity

PACKAGE DIMENSIONS in millimeters



technical drawings according to DIN specifications

Not indicated tolerances ± 0.2

Drawing-No.: 6.550-5263.01-4
Issue: 11; 17.12.08
19009



Disclaimer

All product specifications and data are subject to change without notice.

Vishay Intertechnology, Inc., its affiliates, agents, and employees, and all persons acting on its or their behalf (collectively, "Vishay"), disclaim any and all liability for any errors, inaccuracies or incompleteness contained herein or in any other disclosure relating to any product.

Vishay disclaims any and all liability arising out of the use or application of any product described herein or of any information provided herein to the maximum extent permitted by law. The product specifications do not expand or otherwise modify Vishay's terms and conditions of purchase, including but not limited to the warranty expressed therein, which apply to these products.

No license, express or implied, by estoppel or otherwise, to any intellectual property rights is granted by this document or by any conduct of Vishay.

The products shown herein are not designed for use in medical, life-saving, or life-sustaining applications unless otherwise expressly indicated. Customers using or selling Vishay products not expressly indicated for use in such applications do so entirely at their own risk and agree to fully indemnify Vishay for any damages arising or resulting from such use or sale. Please contact authorized Vishay personnel to obtain written terms and conditions regarding products designed for such applications.

Product names and markings noted herein may be trademarks of their respective owners.