

**Rectifier diodes  
ultrafast**

**BYV72F series**

**GENERAL DESCRIPTION**

Glass passivated, high efficiency, dual, rectifier diodes in a full pack, plastic envelope, featuring low forward voltage drop, ultra-fast recovery times and soft recovery characteristic. They are intended for use in switched mode power supplies and high frequency circuits in general where low conduction and switching losses are essential.

**QUICK REFERENCE DATA**

SYMBOL	PARAMETER	MAX.	MAX.	MAX.	UNIT
$V_{RRM}$	Repetitive peak reverse voltage	<b>100</b>	<b>150</b>	<b>200</b>	V
		100	150	200	
$V_F$	Forward voltage	0.90	0.90	0.90	V
$I_{O(AV)}$	Output current (both diodes conducting)	20	20	20	A
$t_{rr}$	Reverse recovery time	28	28	28	ns

**PINNING - SOT199**

PIN	DESCRIPTION
1	anode 1 (a)
2	cathode (k)
3	anode 2 (a)

**PIN CONFIGURATION**

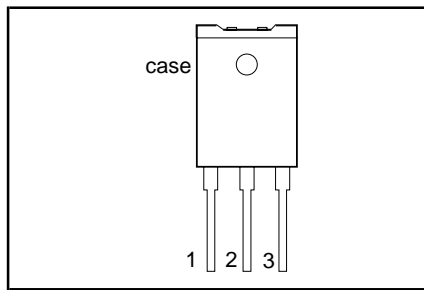

**SYMBOL**

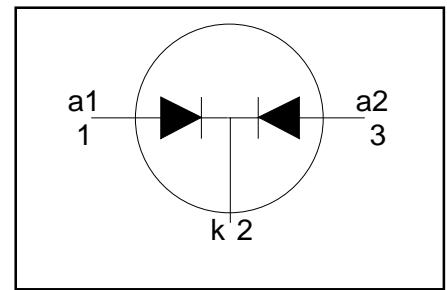

**LIMITING VALUES**

Limiting values in accordance with the Absolute Maximum System (IEC 134).

SYMBOL	PARAMETER	CONDITIONS	MIN.	MAX.			UNIT
				-100	-150	-200	
$V_{RRM}$	Repetitive peak reverse voltage		-	100	150	200	V
$V_{RWM}$	Crest working reverse voltage		-	100	150	200	V
$V_R$	Continuous reverse voltage <sup>1</sup>		-	100	150	200	V
$I_{O(AV)}$	Output current (both diodes conducting) <sup>2</sup>	square wave; $\delta = 0.5$ ;	-	20			A
		$T_{hs} \leq 78^\circ\text{C}$	-	20			A
$I_{O(RMS)}$	RMS forward current	sinusoidal; $a = 1.57$ ;	-	20			A
$I_{FRM}$	Repetitive peak forward current per diode	$T_{hs} \leq 78^\circ\text{C}$	-	30			A
$I_{FSM}$	Non-repetitive peak forward current per diode	$t = 25 \mu\text{s}$ ; $\delta = 0.5$ ;	-	150			A
		$T_{hs} \leq 78^\circ\text{C}$	-	160			A
$I^2t$	$I^2t$ for fusing	$t = 10 \text{ ms}$	-	112			A <sup>2</sup> s
$T_{stg}$	Storage temperature	sinusoidal; with reapplied	-40	150			$^\circ\text{C}$
$T_j$	Operating junction temperature	$V_{RWM(max)}$	-	150			$^\circ\text{C}$
		$t = 10 \text{ ms}$					

1  $T_{hs} \leq 125^\circ\text{C}$  for thermal stability.

2 Neglecting switching and reverse current losses.

## Rectifier diodes ultrafast

## BYV72F series

### ISOLATION LIMITING VALUE & CHARACTERISTIC

$T_{hs} = 25\text{ °C}$  unless otherwise specified

SYMBOL	PARAMETER	CONDITIONS	MIN.	TYP.	MAX.	UNIT
$V_{isol}$	Repetitive peak voltage from all three terminals to external heatsink	R.H. $\leq 65\%$ ; clean and dustfree	-		2500	V
$C_{isol}$	Capacitance from T2 to external heatsink	$f = 1\text{ MHz}$	-	22	-	pF

### THERMAL RESISTANCES

SYMBOL	PARAMETER	CONDITIONS	MIN.	TYP.	MAX.	UNIT
$R_{th\ j-hs}$	Thermal resistance junction to heatsink	both diodes conducting with heatsink compound	-	-	4.0	K/W
		without heatsink compound per diode	-	-	8.0	K/W
$R_{th\ j-a}$	Thermal resistance junction to ambient	with heatsink compound	-	-	5.0	K/W
		without heatsink compound in free air	-	35	9.0	K/W

### STATIC CHARACTERISTICS

$T_j = 25\text{ °C}$  unless otherwise stated

SYMBOL	PARAMETER	CONDITIONS	MIN.	TYP.	MAX.	UNIT
$V_F$	Forward voltage (per diode)	$I_F = 15\text{ A}$ ; $T_j = 150\text{ °C}$	-	0.83	0.90	V
		$I_F = 15\text{ A}$	-	0.95	1.05	V
		$I_F = 30\text{ A}$	-	1.00	1.20	V
$I_R$	Reverse current (per diode)	$V_R = V_{RWM}$ ; $T_j = 100\text{ °C}$	-	0.5	1	mA
		$V_R = V_{RWM}$	-	10	100	$\mu\text{A}$

### DYNAMIC CHARACTERISTICS

$T_j = 25\text{ °C}$  unless otherwise stated

SYMBOL	PARAMETER	CONDITIONS	MIN.	TYP.	MAX.	UNIT
$Q_s$	Reverse recovery charge (per diode)	$I_F = 2\text{ A}$ ; $V_R \geq 30\text{ V}$ ; $-di_F/dt = 20\text{ A}/\mu\text{s}$	-	6	15	nC
$t_{rr}$	Reverse recovery time (per diode)	$I_F = 1\text{ A}$ ; $V_R \geq 30\text{ V}$ ; $-di_F/dt = 100\text{ A}/\mu\text{s}$	-	20	28	ns
$I_{rrm}$	Peak reverse recovery current (per diode)	$I_F = 10\text{ A}$ ; $V_R \geq 30\text{ V}$ ; $-di_F/dt = 50\text{ A}/\mu\text{s}$ ; $T_j = 100\text{ °C}$	-	2	2.4	A
$V_{fr}$	Forward recovery voltage (per diode)	$I_F = 1\text{ A}$ ; $di_F/dt = 10\text{ A}/\mu\text{s}$	-	1	-	V

Rectifier diodes  
ultrafast

BYV72F series

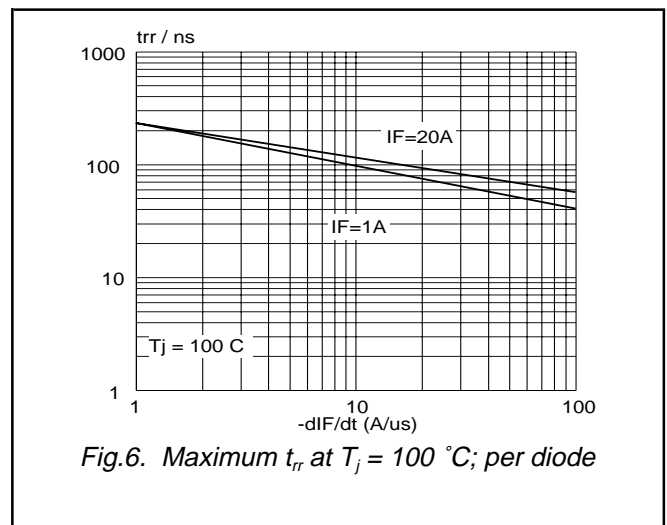
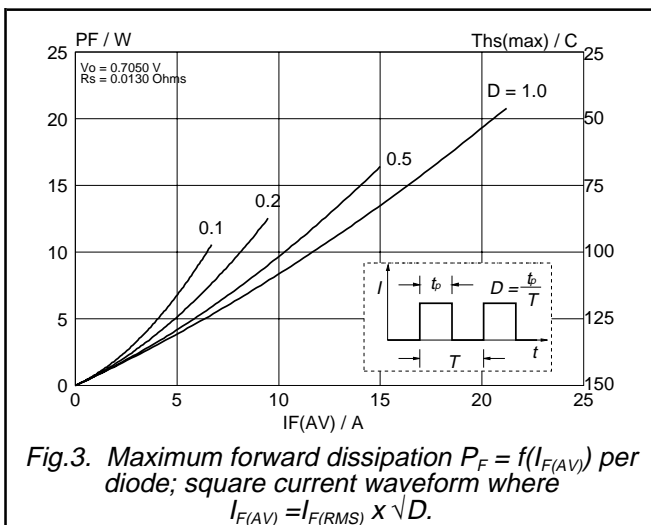
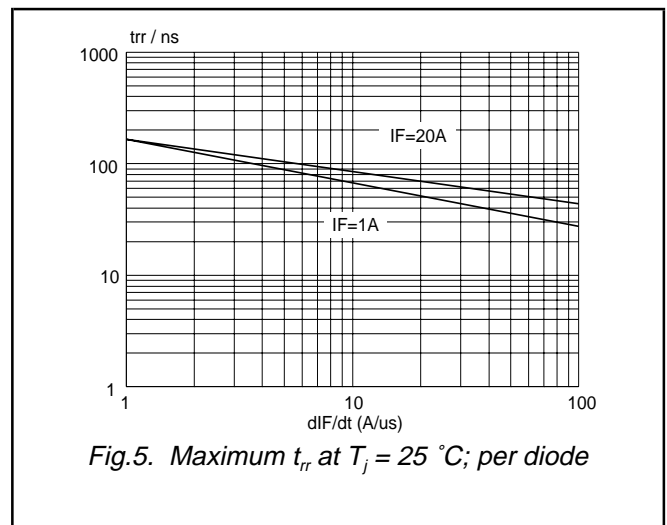
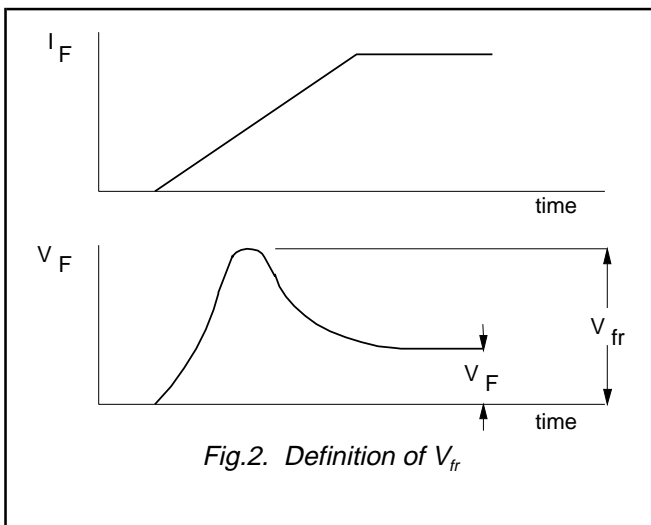
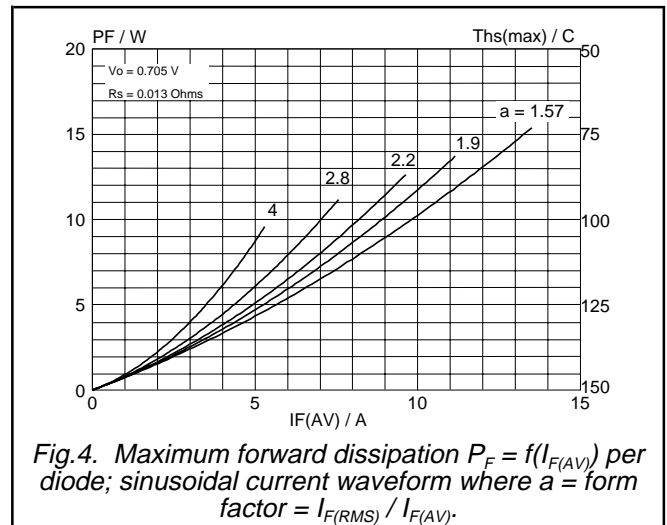
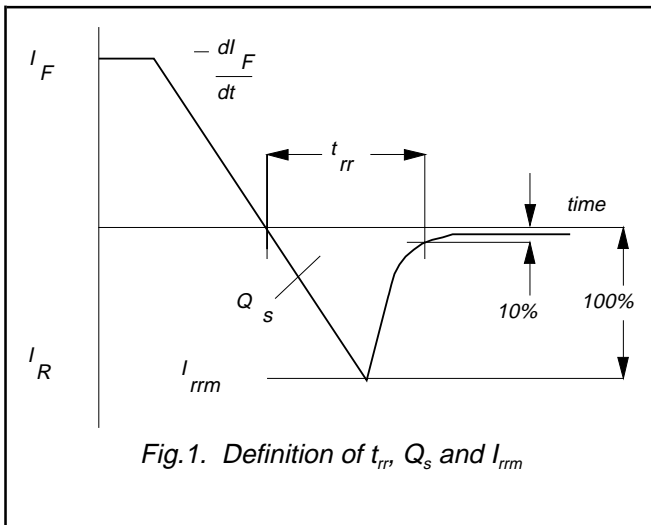

Rectifier diodes  
ultrafast

BYV72F series

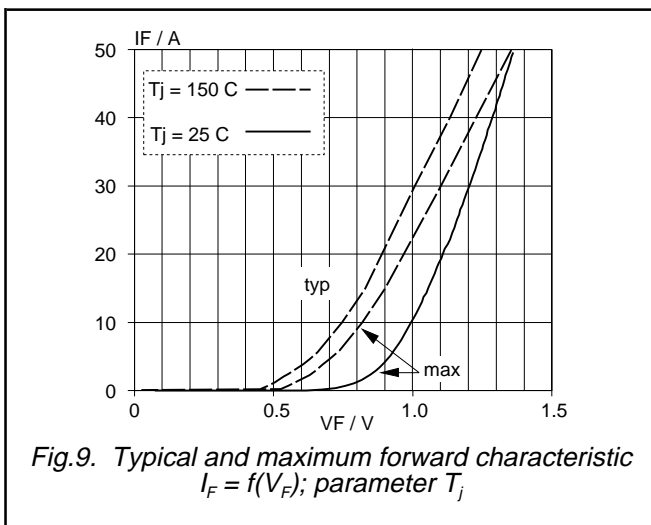
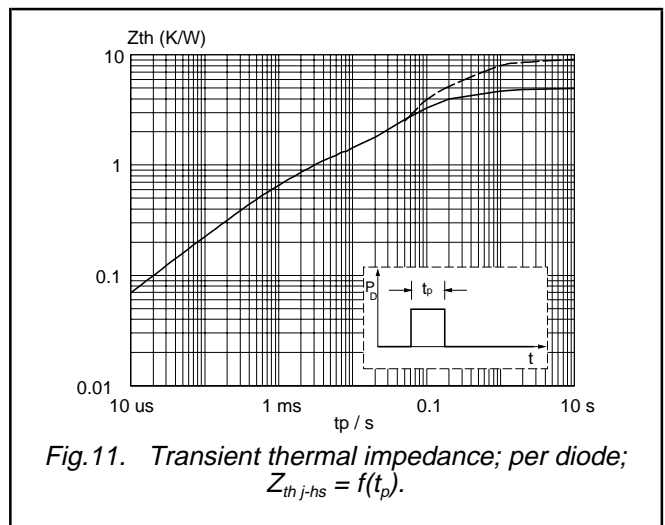
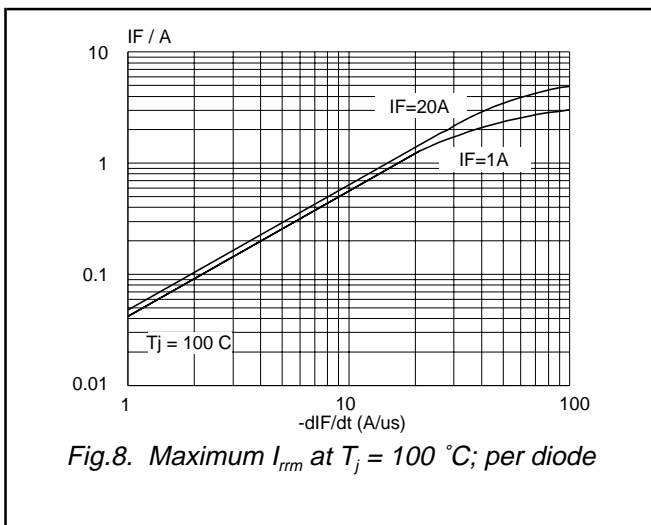
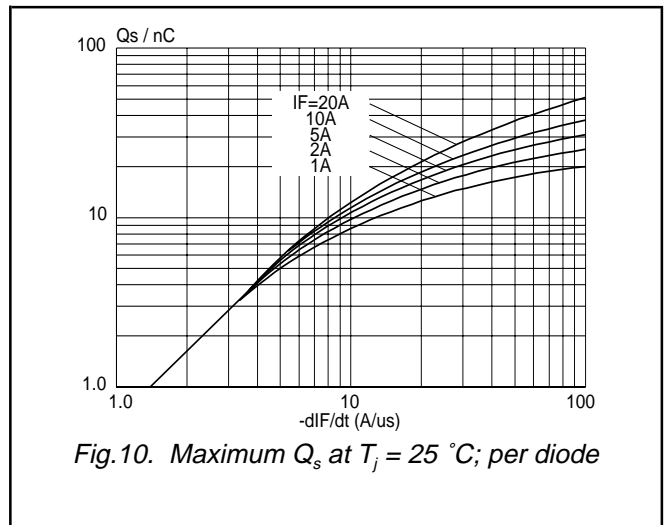
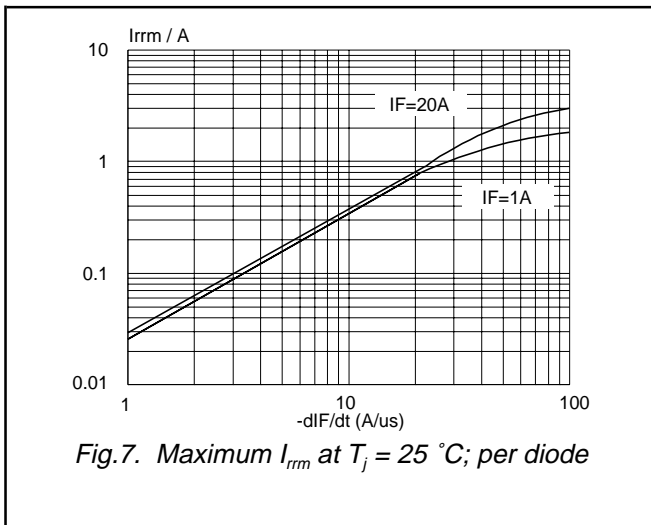

Rectifier diodes  
ultrafast

BYV72F series

**MECHANICAL DATA**

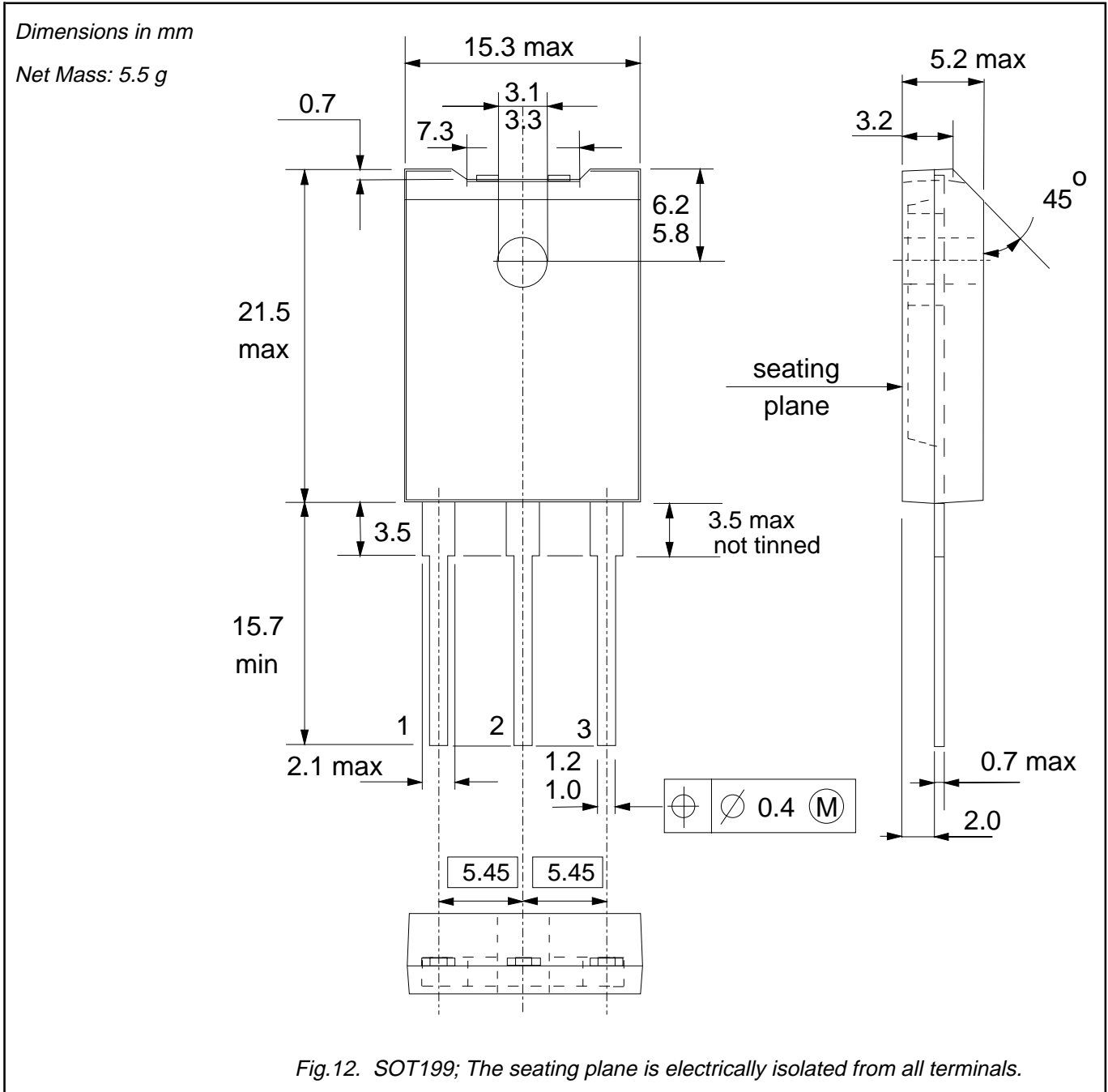

**Notes**

- 1. Refer to mounting instructions for F-pack envelopes.
- 2. Epoxy meets UL94 V0 at 1/8".

---

**Rectifier diodes  
ultrafast**

---

**BYV72F series**

---

**DEFINITIONS**

<b>Data sheet status</b>	
Objective specification	This data sheet contains target or goal specifications for product development.
Preliminary specification	This data sheet contains preliminary data; supplementary data may be published later.
Product specification	This data sheet contains final product specifications.
<b>Limiting values</b>	
Limiting values are given in accordance with the Absolute Maximum Rating System (IEC 134). Stress above one or more of the limiting values may cause permanent damage to the device. These are stress ratings only and operation of the device at these or at any other conditions above those given in the Characteristics sections of this specification is not implied. Exposure to limiting values for extended periods may affect device reliability.	
<b>Application information</b>	
Where application information is given, it is advisory and does not form part of the specification.	
© Philips Electronics N.V. 1997	
All rights are reserved. Reproduction in whole or in part is prohibited without the prior written consent of the copyright owner.	
The information presented in this document does not form part of any quotation or contract, it is believed to be accurate and reliable and may be changed without notice. No liability will be accepted by the publisher for any consequence of its use. Publication thereof does not convey nor imply any license under patent or other industrial or intellectual property rights.	

**LIFE SUPPORT APPLICATIONS**

These products are not designed for use in life support appliances, devices or systems where malfunction of these products can be reasonably expected to result in personal injury. Philips customers using or selling these products for use in such applications do so at their own risk and agree to fully indemnify Philips for any damages resulting from such improper use or sale.