

# Rectifier diode fast, high-voltage

**BY459F-1500**

## GENERAL DESCRIPTION

Glass-passivated double diffused rectifier diode in a full pack plastic envelope, featuring fast forward recovery and low forward recovery voltage. The device is intended for use in multi-sync monitor horizontal deflection circuits.

## QUICK REFERENCE DATA

SYMBOL	PARAMETER	MAX.	UNIT
$V_{RRM}$	Repetitive peak reverse voltage	1500	V
$V_F$	Forward voltage	1.2	V
$I_{FWM}$	Working peak forward current	10	A
$I_{FRM}$	Repetitive peak forward current	100	A
$t_{fr}$	Forward recovery time	250	ns
$V_{fr}$	Forward recovery voltage	14	V

## PINNING - SOD100

PIN	DESCRIPTION
1	cathode
2	anode
case	isolated

## PIN CONFIGURATION

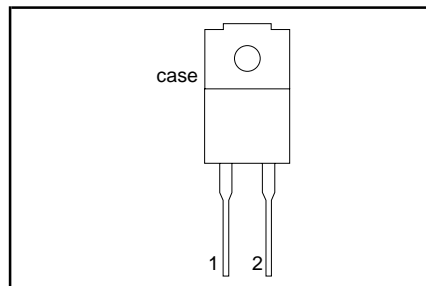

## SYMBOL

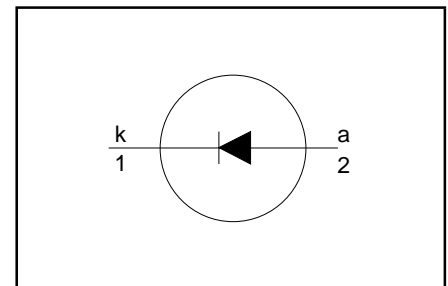

## LIMITING VALUES

Limiting values in accordance with the Absolute Maximum System (IEC 134).

SYMBOL	PARAMETER	CONDITIONS	MIN.	MAX.	UNIT
$V_{RSM}$	Non-repetitive peak reverse voltage during flash-over of picture tube		-	1500	V
$V_{RRM}$	Repetitive peak reverse voltage	$t = 6 \mu s; f = 82 kHz$	-	1500	V
$V_{RWM}$	Crest working reverse voltage		-	1300	V
$I_{FWM}$	Working peak forward current <sup>1</sup>	$f = 82 kHz; T_{hs} \leq 127^\circ C$	-	10	A
$I_{FRM}$	Repetitive peak forward current	$t = 100 \mu s$	-	100	A
$I_{FSM}$	Non-repetitive peak forward current	$t = 10 ms$ $t = 8.3 ms$ sinusoidal; $T_j = 150^\circ C$ prior to surge; with reapplied $V_{RWM(max)}$	-	100	A
$T_{stg}$	Storage temperature		-40	150	$^\circ C$
$T_j$	Operating junction temperature		-	150	$^\circ C$

## ISOLATION LIMITING VALUE & CHARACTERISTIC

$T_{hs} = 25^\circ C$  unless otherwise specified

SYMBOL	PARAMETER	CONDITIONS	MIN.	TYP.	MAX.	UNIT
$V_{isol}$	Repetitive peak voltage from both terminals to external heatsink	R.H. $\leq 65\%$ ; clean and dustfree	-		1500	V
$C_{isol}$	Capacitance from cathode to external heatsink	$f = 1 MHz$	-	12	-	pF

<sup>1</sup> Including worst case forward recovery losses, see fig:5.

## Rectifier diode fast, high-voltage

BY459F-1500

### THERMAL RESISTANCES

SYMBOL	PARAMETER	CONDITIONS	MIN.	TYP.	MAX.	UNIT
$R_{th\ j-hs}$	Thermal resistance junction to heatsink	with heatsink compound	-	-	4.8	K/W
$R_{th\ j-a}$	Thermal resistance junction to ambient	without heatsink compound in free air	-	55	5.9	K/W
			-		-	K/W

### STATIC CHARACTERISTICS

$T_j = 25\text{ °C}$  unless otherwise stated

SYMBOL	PARAMETER	CONDITIONS	MIN.	TYP.	MAX.	UNIT
$V_F$	Forward voltage	$I_F = 6.5\text{ A}$	-	0.95	1.3	V
$I_R$	Reverse current	$I_F = 6.5\text{ A}; T_j = 125\text{ °C}$	-	0.85	1.2	V
		$V_R = V_{RWMmax}$	-	-	0.25	mA
		$V_R = V_{RWMmax}; T_j = 125\text{ °C}$	-	-	1.0	mA

### DYNAMIC CHARACTERISTICS

$T_j = 25\text{ °C}$  unless otherwise stated

SYMBOL	PARAMETER	CONDITIONS	MIN.	TYP.	MAX.	UNIT
$V_{fr}$	Forward recovery voltage	$I_F = 6.5\text{ A}; di_F/dt = 50\text{ A}/\mu\text{s}$	-	8	14	V
$t_{fr}$	Forward recovery time	$I_F = 6.5\text{ A}; di_F/dt = 50\text{ A}/\mu\text{s}; V_F = 5\text{ V}$	-	170	250	ns
		$I_F = 6.5\text{ A}; di_F/dt = 50\text{ A}/\mu\text{s}; V_F = 2\text{ V}$	-	350	-	ns
$t_{rr}$	Reverse recovery time	$I_F = 1\text{ A}; -di_F/dt = 50\text{ A}/\mu\text{s}; V_R \geq 30\text{ V}$	-	250	350	ns
$Q_s$	Reverse recovery charge	$I_F = 2\text{ A}; -di_F/dt = 20\text{ A}/\mu\text{s}; V_R \geq 30\text{ V}$	-	2.0	3.0	$\mu\text{C}$

Rectifier diode  
fast, high-voltage

BY459F-1500

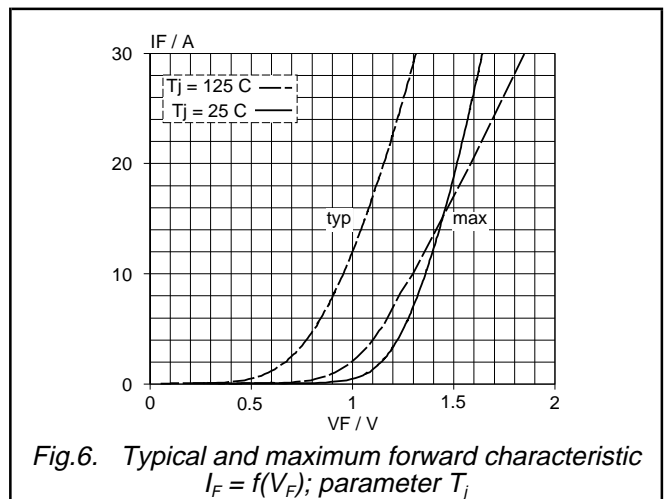
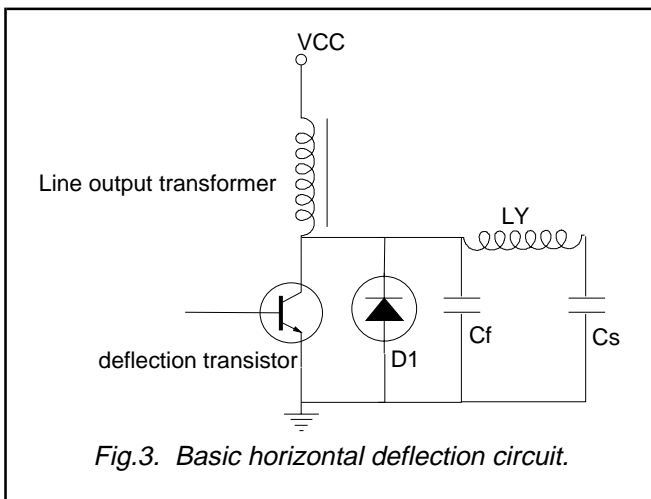
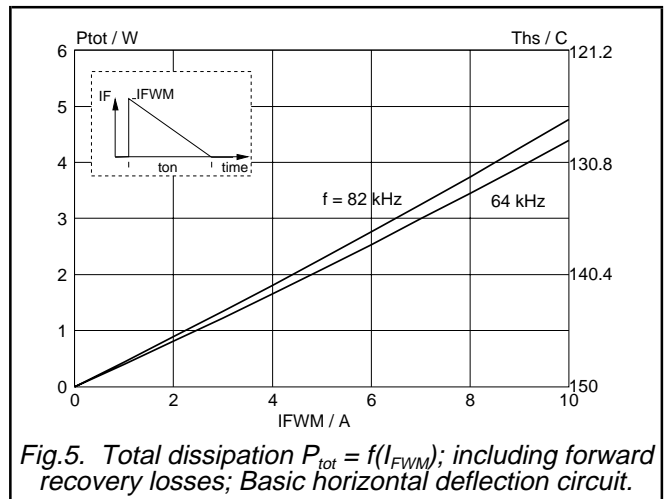
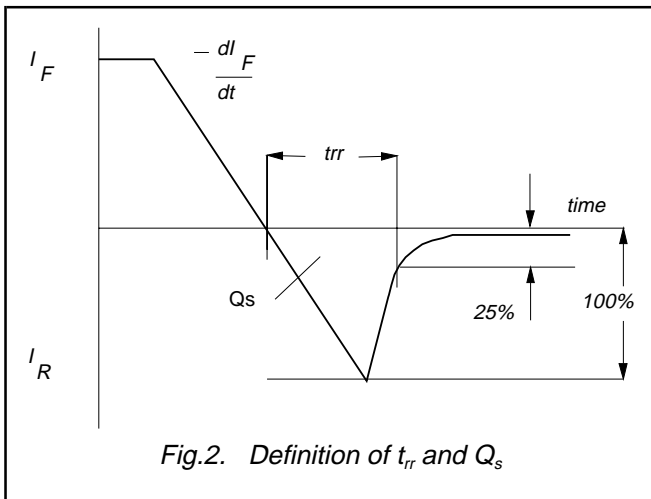
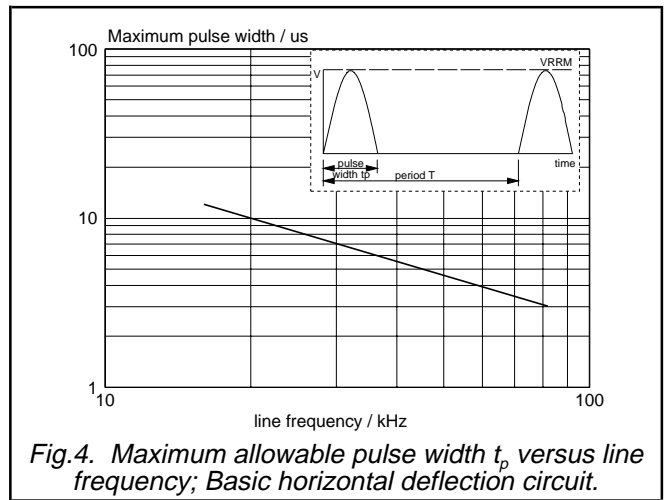
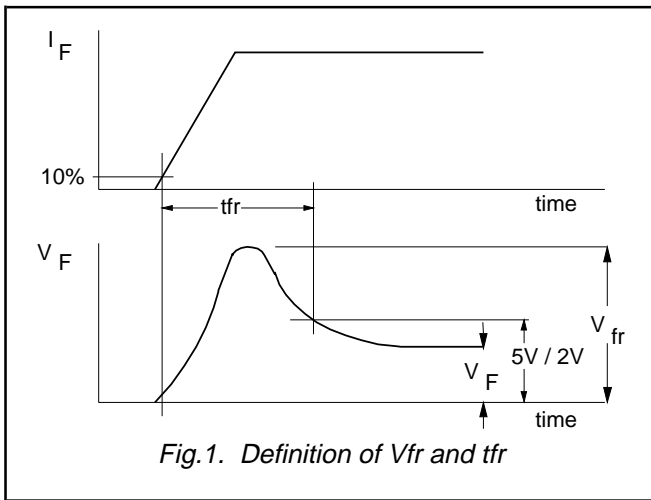

Rectifier diode  
fast, high-voltage

BY459F-1500

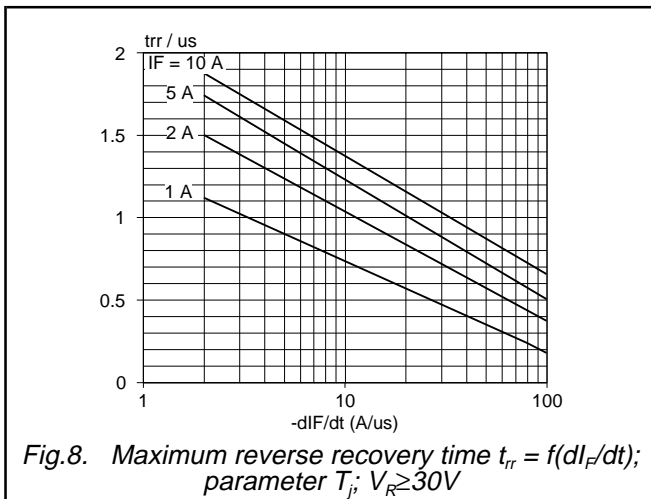
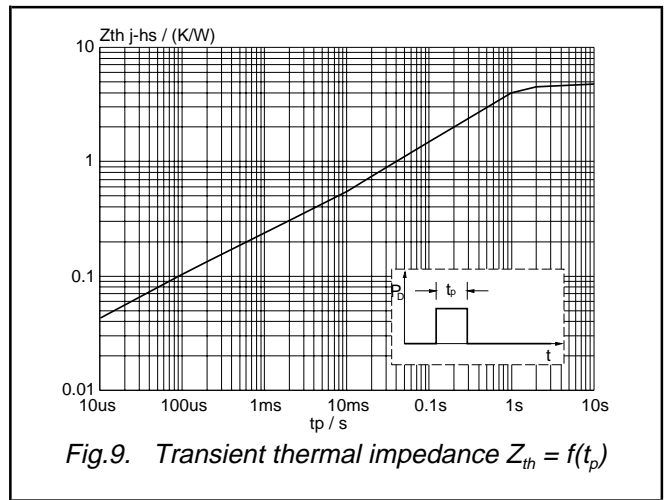
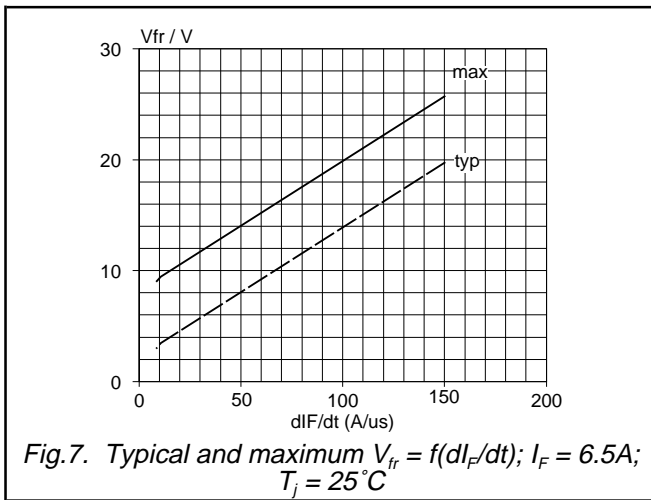

Rectifier diode  
fast, high-voltage

BY459F-1500

**MECHANICAL DATA**

*Dimensions in mm*

*Net Mass: 2 g*

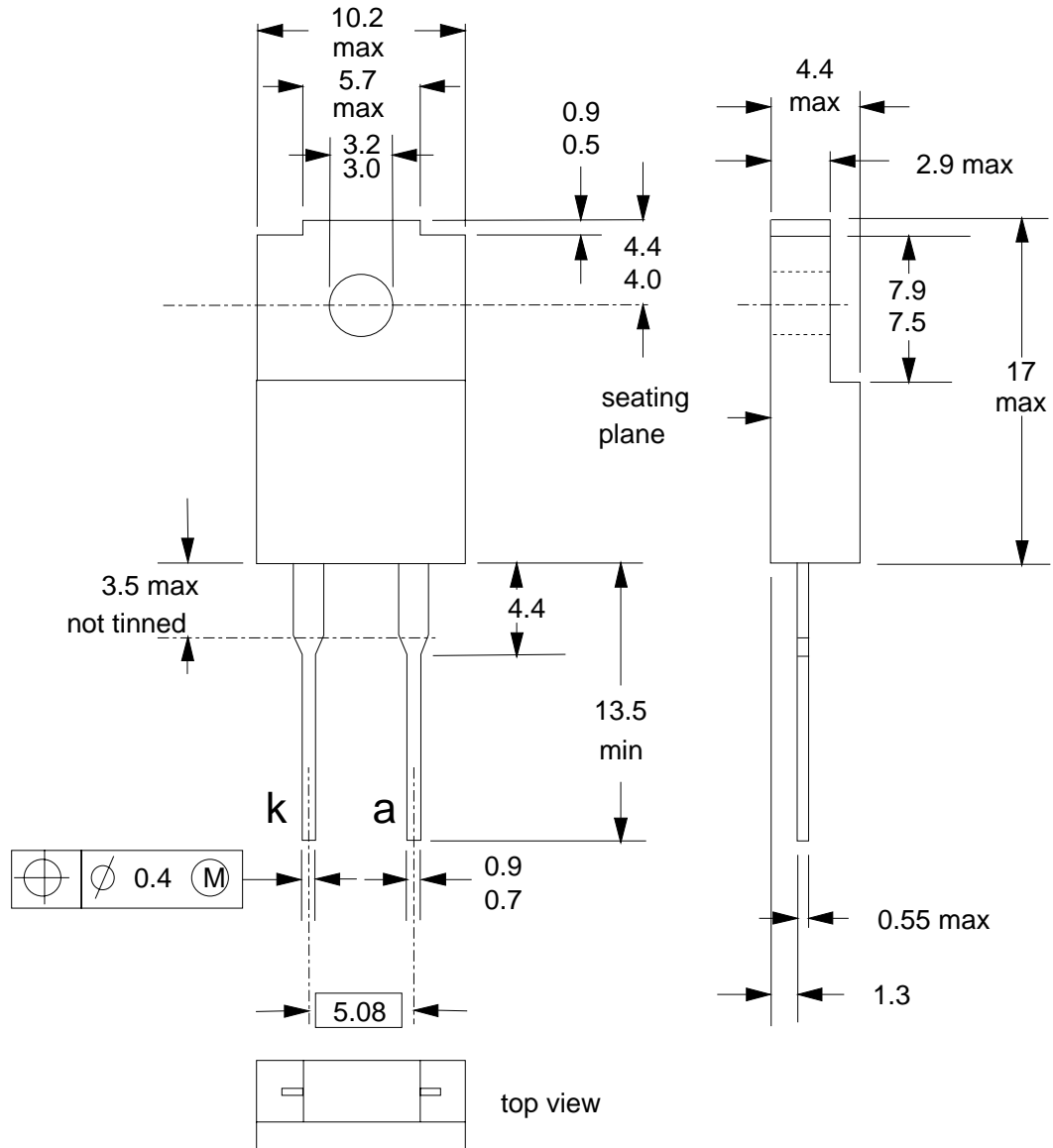

Fig. 10. SOD100; The seating plane is electrically isolated from all terminals.

**Notes**

1. Refer to mounting instructions for F-pack envelopes.
2. Epoxy meets UL94 V0 at 1/8".

---

**Rectifier diode  
fast, high-voltage**

---

BY459F-1500

**DEFINITIONS**

<b>Data sheet status</b>	
Objective specification	This data sheet contains target or goal specifications for product development.
Preliminary specification	This data sheet contains preliminary data; supplementary data may be published later.
Product specification	This data sheet contains final product specifications.
<b>Limiting values</b>	
Limiting values are given in accordance with the Absolute Maximum Rating System (IEC 134). Stress above one or more of the limiting values may cause permanent damage to the device. These are stress ratings only and operation of the device at these or at any other conditions above those given in the Characteristics sections of this specification is not implied. Exposure to limiting values for extended periods may affect device reliability.	
<b>Application information</b>	
Where application information is given, it is advisory and does not form part of the specification.	
<b>© Philips Electronics N.V. 1996</b>	
All rights are reserved. Reproduction in whole or in part is prohibited without the prior written consent of the copyright owner.	
The information presented in this document does not form part of any quotation or contract, it is believed to be accurate and reliable and may be changed without notice. No liability will be accepted by the publisher for any consequence of its use. Publication thereof does not convey nor imply any license under patent or other industrial or intellectual property rights.	

**LIFE SUPPORT APPLICATIONS**

These products are not designed for use in life support appliances, devices or systems where malfunction of these products can be reasonably expected to result in personal injury. Philips customers using or selling these products for use in such applications do so at their own risk and agree to fully indemnify Philips for any damages resulting from such improper use or sale.