

MSO

MUSIC WORKSTATION

Editor/Plug-In Editor Manual



EDS Enhanced Definition
Synthesis

TouchView
Graphical User Interface

REMS

GENERAL
MI

KORG

Table of Contents

Introduction	1
Main features	1
Please note before use.....	1
M50 Editor and M50 Plug-In Editor operating requirements	1
Installation	2
Installation in Windows XP / Windows Vista	2
Installing the Korg USB-MIDI Driver	2
Installing the M50 Editor / Plug-In Editor	3
Installation in Mac OS X	5
Setup	7
M50 Setup	7
M50 Editor (stand-alone version) setup.....	7
Windows XP / Windows Vista.....	7
Mac OS X.....	7
Setting up the M50 Plug-In Editor	8
About the M50 Plug-In Editor.....	8
Using an external mixer to control the M50's audio signal.....	9
Using your host application to control the M50's audio signal.....	9
Host application settings	10
Apple - Logic Pro 8.....	10
Steinberg - Cubase 4.....	11
Ableton - Live 7.....	12
MOTU – Digital Performer 5	13
Digidesign – Pro Tools LE 7.....	14
Other host applications.....	15
About MIDI timing	15
Basic functions and operation.....	16
Start-up	16
M50 Editor.....	16
M50 Plug-In Editor.....	16
About the Preload data	16
Items in the screen	17
Connection indicator (KORG logo)	17
Operating procedure	19
Selecting a mode	19
Selecting programs, combinations, and songs.....	19
Auditioning programs, and selecting a program to edit	19

Editor operations	20
Selecting pages and tabs	21
Selecting a parameter and editing the value	21
Selecting and executing utility functions	21
Writing (saving)	22
Functions provided by the M50	24
Functions specific to the editor	25
Utility commands	25
Software Setup (Initial settings for M50 Editor)	27
Cautions	29
USB connection.....	29

- Apple, Mac, Logic pro and Audio Units are trademarks of Apple Inc., registered in the US. and other countries.
- Windows XP and Windows Vista are registered trademarks of Microsoft Corporation in the U.S. and other countries.
- Cubase and VST are trademarks of Steinberg Media Technologies GmbH.
- Live is a trademark of Ableton AG.
- Digital Performer is a trademark of Mark of the Unicorn, Inc.
- Pro Tools LE and RTAS are trademarks or registered trademarks of Avid Technology, Inc., or its subsidiaries or divisions.
- All other product and company names are trademarks or registered trademarks of their respective holders.

Introduction

Thank you for purchasing the Korg M50 Workstation. To help you get the most out of your new instrument, please read this manual carefully.

Main features

The M50 Editor and the M50 Plug-In Editor are applications for Macintosh or Windows that allow you to edit the M50's programs, combinations, songs, drum kits, arpeggio patterns, effects, and global settings.

The M50 Editor is a stand-alone editor.

The M50 Plug-In Editor is an editor that is compatible with the VST, Audio Units, or RTAS formats. It lets you use the M50 just like a plug-in instrument from within your DAW (Digital Audio Workstation) software or other host application.

Please note before use

- Copyright to all software included in this product is the property of Korg Inc.
- The license agreement for this software is provided separately. You must read this license agreement before you install this software. Your installation of this software will be taken to indicate your acceptance of this agreement.

M50 Editor and M50 Plug-In Editor operating requirements

Note: It is not possible to open and run multiple instances of the M50 Editor or M50 Plug-In Editor; this means that it is not possible to edit more than one M50 synthesizer simultaneously.

Windows

- Computer
 - CPU: Intel Pentium III / 1 GHz or better (Pentium D or Core Duo more are recommended)
 - Memory: 512 MB or more (1 GB or more is recommended)
 - Monitor: 1,024 x 768 pixels, 16-bit color or better
 - A computer with a USB port, that satisfies the requirements of Windows XP / Windows Vista
- Operating system
 - Microsoft Windows XP Home Edition or Professional, Service Pack 2 or later
 - All editions of Microsoft Windows Vista Service Pack 1 or later (excluding 64-bit editions)

Macintosh

- Computer
 - CPU: PowerPC G4 800 MHz or better (Intel Mac is supported), G5 or Core Duo or better is recommended
 - Memory: 512 MB or more (1 GB or more is recommended)
 - Monitor: 1,024 x 768 pixels, 32,000 colors or better
 - An Apple Macintosh with a USB port that satisfies the requirements of Mac OS X
- Operating system
 - Mac OS X version.10.4.11 or later

Note: M50 Plug-In Editor must also satisfy the operating requirements of the host application.

Installation

Installation in Windows XP / Windows Vista

To install the M50 Editor and the M50 Plug-In Editor into Windows XP or Windows Vista, proceed as follows.

 If you want to connect the M50 to your computer via USB and use the M50 Editor and the M50 Plug-In Editor, you must install the Korg USB-MIDI Driver. (Refer to the Installation Guide for details on how to install the Korg USB-MIDI Driver.)

- 1 Insert the included CD-ROM into your computer's CD-ROM drive. Normally the "M50 Application Installer" will start up automatically. If your computer is set so the installer does not run automatically, double-click "KorgSetup.exe" on the CD-ROM.
- 2 From the list, select the applications that you want to install, and click [Install].



The applications you selected will begin the installation process.

- 3 Follow the on-screen directions to install the desired applications, such as M50 Editor.
- 4 When you've finished installing all the selected software, close the installer.

Installing the Korg USB-MIDI Driver

Refer to the Installation Guide for details on how to install the Korg USB-MIDI Driver.

Installing the M50 Editor / Plug-In Editor

- 1 “M50 Editor/Plug-In Editor Installer” will appear. Select and install all desired components, such as, the Editor (Standalone), Plug-In Editor (VST), and/or Plug-In Editor (RTAS). For example if you want to install the stand-alone version, click [Install Standalone Application].

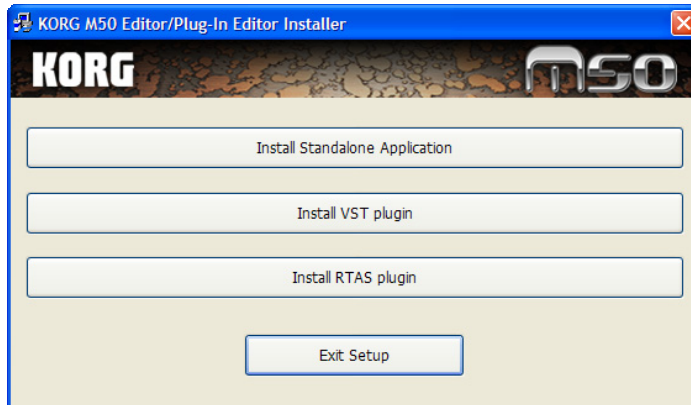

- 2 The M50 Editor screen will appear. Click [Next>].
- 3 The “Welcome to the M50 Editor setup wizard” screen will appear. Click [Next>].
- 4 “M50 Editor information” will appear. Read the displayed content, and click [Next>].
- 5 The “License agreement” will appear. Carefully read the contents, and if you agree, check “I accept the terms of the license agreement” and click [Next>].
- 6 The “Select installation folder” screen will appear. Choose the location and user(s) for which you want to install the software, and click [Next>].

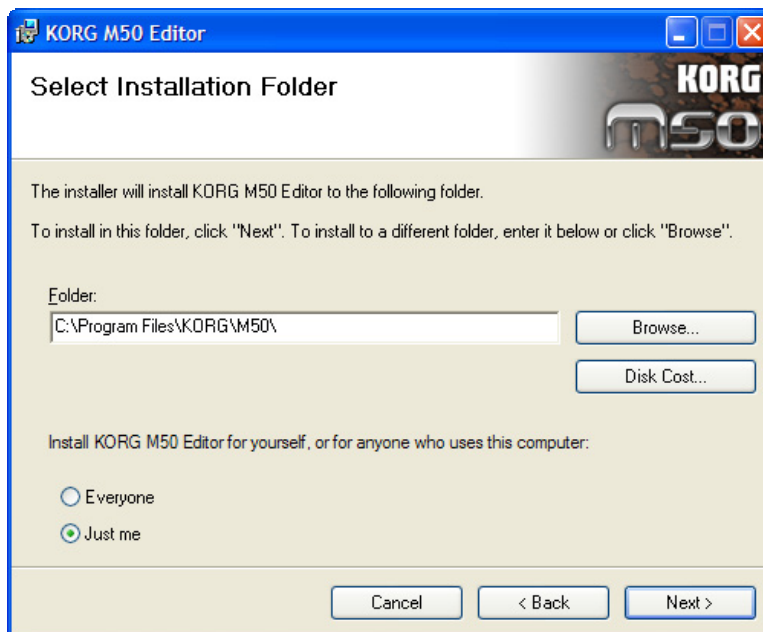

- 7 “Verify installation” will appear. To proceed with the installation, click [Next>]. Installation will begin.

-
- 8 If the installation was successful, click [Close].
“M50 Editor/Plug-In Editor Installer” will appear.
 - 9 Next you will install the plug-in version(s) that you want to use. Using the procedure described above, begin with step 1 and install the plug-in version(s) that you want to use. If you don't want to install the VST plug-in version or RTAS plug-in version, click [Exit Setup] to end the installation.
When you've finished installing the application(s) you want, click [Exit Setup] to exit the installer.

Installation in Mac OS X

To install the M50 Editor and M50 Plug-In Editor into Mac OS X, use the following procedure.

 You must install the KORG USB-MIDI Driver if you want to connect the M50 to your computer via USB and use the M50 Editor or M50 Plug-In Editor. (For details on installing the KORG USB-MIDI Driver, refer to the Install Guide.)

- 1 Insert the included CD-ROM into your CD-ROM drive.
- 2 Start up the installer by double-clicking “M50 Editor Installer.pkg” located in the “M50 Editor” folder of the CD-ROM.
- 3 Depending on the version of your Mac’s operating system, a confirmation dialog box may appear at this point. If required, please enter your password and click [OK].
When the installer starts up, the following screen will appear. Click [Continue].



- 4 “Important information” will appear. Read the contents, and click [Continue].
- 5 The “License agreement” will appear. Carefully read the contents, and click [Continue]. A dialog box will ask whether you accept the terms of the license agreement. If you accept, click [Agree].

- 6 A screen where you can choose the “Installation destination” will appear. Select the installation destination of your choice and click [Continue].

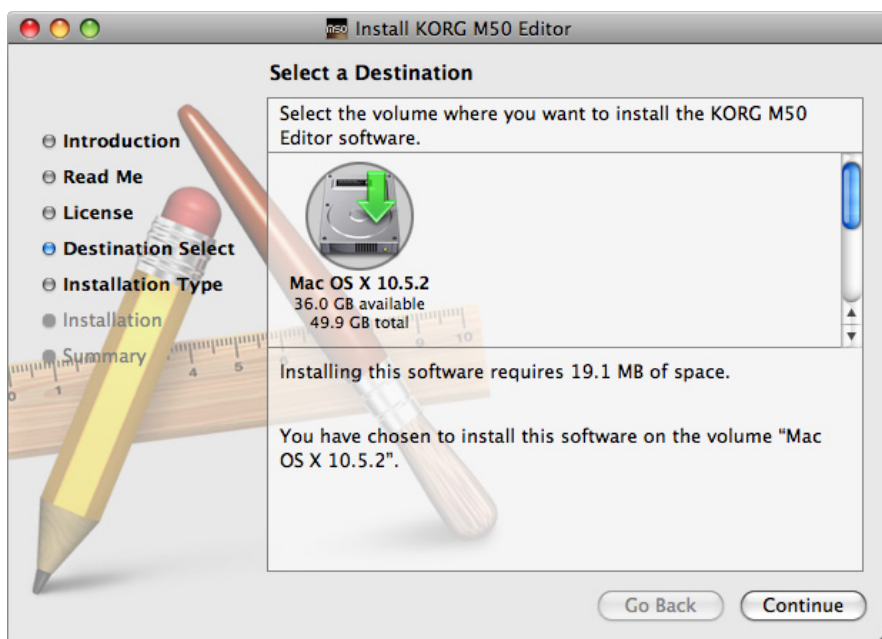

- 7 The “Easy Installation” dialog box will appear. Click [Install].
- 8 Depending on the version of your Mac’s operating system, a confirmation dialog box may appear at this point. If so, please enter your password and click [OK].
- 9 When the installation has been successfully completed, click [Restart] to exit the installer.
-  You can’t connect two or more M50 units to a single computer and use them simultaneously.
Note: Under Mac OS X, the plug-in version will also be installed in the appropriate folder.

Setup

M50 Setup

 If you want to use the M50 Editor with the M50 connected to your computer via USB, you must make sure that you've finished installing and setting-up the KORG USB-MIDI Driver before you start up the M50 Editor.

- 1 Use a USB cable to connect the M50's USB connector to the USB port of your computer.
- 2 In the M50's Global mode, make sure that MIDI Filter "Enable Exclusive" is on (the check box should be checked). (The factory setting is on.)

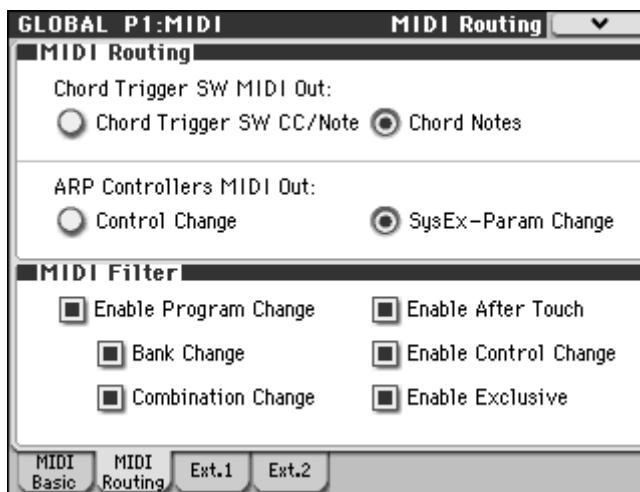

M50 Editor (stand-alone version) setup

Start up the M50 Editor and verify that it's operating correctly.

Windows XP / Windows Vista

Starting up the M50 Editor

Navigate to the "KORG" folder → "M50" folder, and double-click the "M50 Editor.exe" icon.

The "KORG" folder is in the location you selected during installation. By default it's in the "Program Files" folder.

Alternatively, you can start up the editor by clicking the taskbar [Start] button → [All Programs] and then pointing to "KORG" – "M50" – "M50 Editor."

Mac OS X

Starting up the M50 Editor

Navigate to the "Applications" folder – "KORG" folder – "M50" folder, and double click the "M50 Editor" icon.

Setting up the M50 Plug-In Editor

⚠ If you want to use the M50 Editor with the M50 connected to your computer via USB, you must make sure that you have finished installing and setting-up the KORG USB-MIDI Driver before you start up the M50 Editor.

This section explains how to set up the M50 Plug-In Editor in your host application and create settings so that it will operate correctly.

About the M50 Plug-In Editor

Parameter data is sent and received between the M50 Plug-In Editor and the M50. Unlike typical plug-in instruments, the M50 Plug-In Editor does not produce an audio signal.

Your M50 will output audio signals when the M50 Plug-In Editor sends it MIDI messages.

If you want to send the M50's audio signal to an audio track of your host application and use it in conjunction with a plug-in effect etc., refer to “Using your host application to control the M50's audio signal” (p.9)

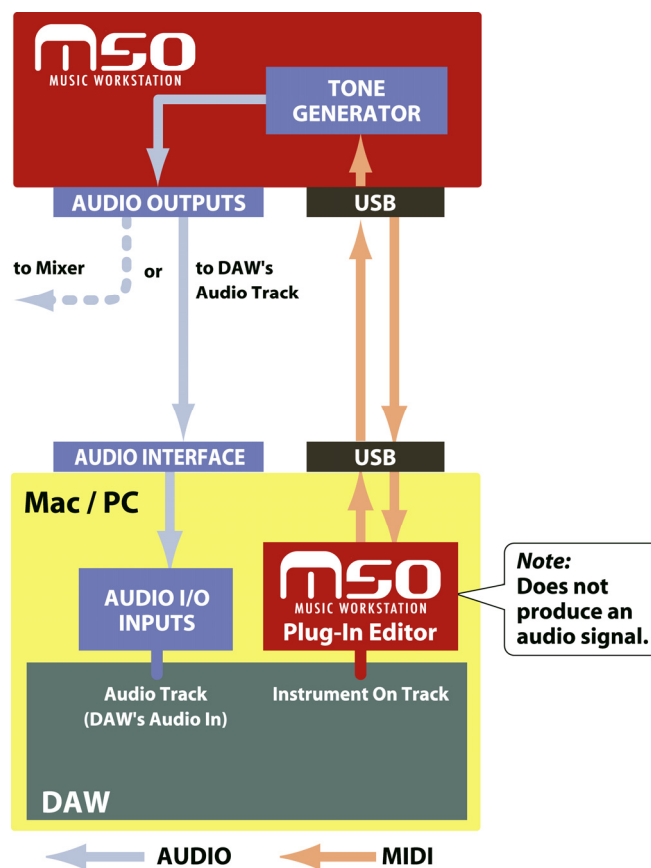

Note: Because the M50 Plug-In Editor does not handle audio signals, you can't insert a plug-in effect into the channel of the track in which the M50 Plug-In Editor is inserted, or send its audio signal via a send or bus.

Using an external mixer to control the M50's audio signal

If you want to mix the M50's audio signals with the audio signals sent from your host application via your audio interface, or with audio signals from another sound module, make connections as shown below.

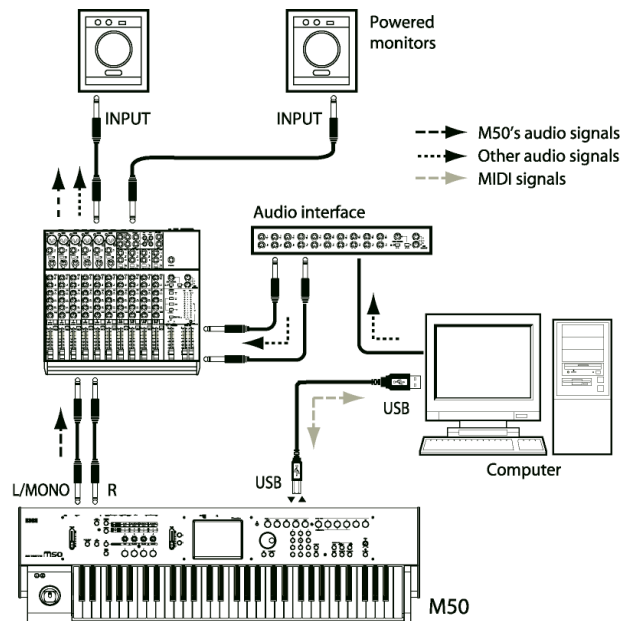

Using your host application to control the M50's audio signal

If you want to apply a plug-in effect to the M50's audio signal, or to control the M50's audio signal in your host application along with other audio tracks, connect the M50 to your audio interface and route the audio signal into your host application. Refer to the example explanations for various popular host applications on the following pages.

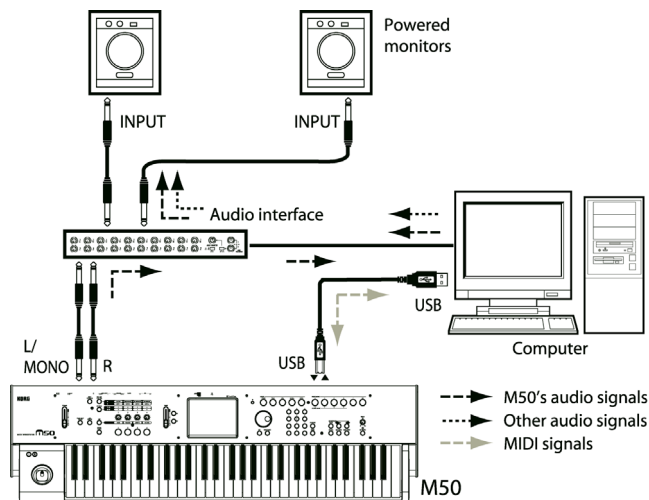

Note: For details on creating audio tracks, MIDI tracks, and plug-in instrument tracks, and on how to perform operations and make settings in your host application, refer to the host application's owner's manual.

Host application settings

The following material explains how to start up the M50 Plug-In Editor in your host application and **select** the appropriate settings for it to operate properly. Please proceed to the specific explanation for the system you're using.

Apple - Logic Pro 8

- 1 Start up Logic Pro 8.
- 2 Create a Software Instrument Track, and initialize the "M50 Plug-In Editor."

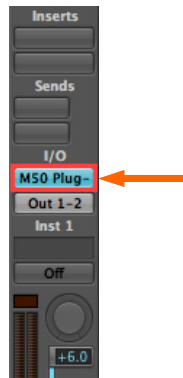

Software Instrument Track

- 3 To route the M50's audio signal into Logic Pro 8, create an audio track or an audio AUX track. On the I/O source for that track, select the audio interface input to which you've connected the M50's audio signal.



Audio Track

- 4 If you're routing the M50's audio signal to an audio track, arm the REC button so that you can hear/monitor the audio signal. If you are routing the M50's audio signal to an audio AUX track, this setting is not necessary.

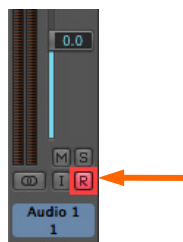

Audio Track

Steinberg - Cubase 4

- 1 Start up Cubase 4 and create a project.
- 2 In the VST Instruments window, start up “M50 Plug-In Editor.”



- 3 Create a MIDI track. In the output section of that MIDI track, choose “M50 Plug-In Editor” which you started up in the VST Instruments window.



- 4 To route the M50's audio signal to Cubase 4, create an audio track. On the input section of the track, select the audio interface input to which you've connected the M50's audio signal.

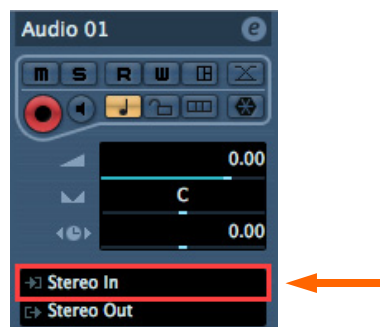

- 5 Turn the Monitor button on so that you can hear/monitor the audio signal.



Ableton - Live 7

- 1 Start up Live 7, and choose “View” → “Session View.”
- 2 From the plug-in device browser, drag and drop “M50 Plug-In Editor” onto the session view. This will create a MIDI track with “M50 Plug-In Editor” started up. Verify that “M50 Plug-In Editor” is running in the MIDI track view.



- 3 Press the arm button so that the MIDI input from the external source will be sent to “M50 Plug-In Editor.”

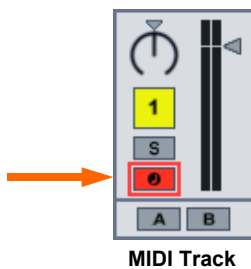

- 4 To route the M50’s audio signal to Live 7, create an audio track. In the input area of the audio input/output section, select the audio interface input to which you’ve connected the M50’s audio signal.



- 5 Set the Monitor setting to “In” so that you can hear the audio signal of the M50.



MOTU – Digital Performer 5

- 1 Start up Digital Performer 5.
- 2 Create an instrument track. Start up “M50 Plug-In Editor.”

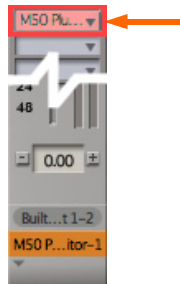

Instrument Track

- 3 Create a MIDI track. Choose “M50 Plug-In Editor” as the output of that MIDI track.

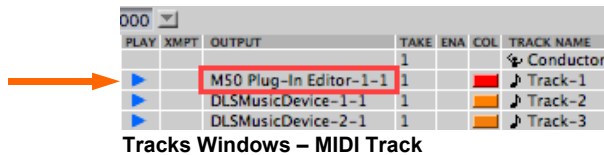

Tracks Windows – MIDI Track

- 4 To route the M50’s audio signal to Digital Performer 5, create an audio track or an AUX track. On the input section of that track, select the audio interface input to which you’ve connected the M50’s audio signal.

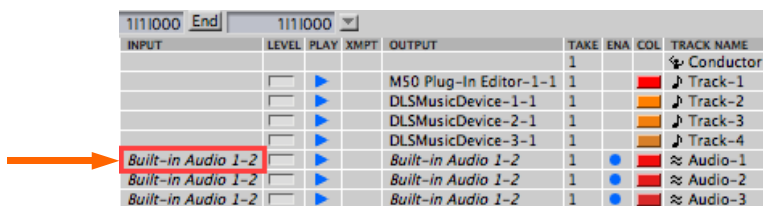

Tracks Windows – MIDI Track

- 5 If you’re routing the M50’s audio signal to an audio track, arm the REC button on so that you can hear the audio signal.
If you are routing the M50’s audio signal to an AUX track, this step is not necessary.

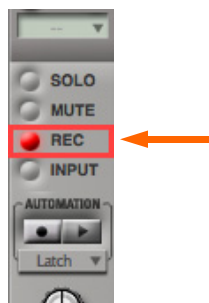

Audio Track

Digidesign – Pro Tools LE 7

1 Start up Pro Tools LE 7, and open a session.

2 Create an audio track (stereo), and start up “M50 Plug-In Editor.”

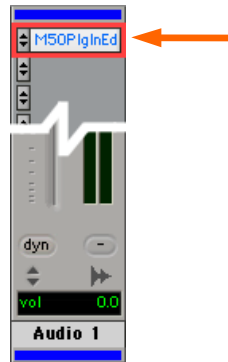

Audio Track

3 Create a MIDI track. Choose “M50 Plug-In Editor” as the output of that MIDI track.



MIDI Track

4 To route the M50’s audio signal to Pro Tools LE 7, create an audio track or an AUX input track. On the input section, please select the audio interface input to which you’ve connected the M50’s audio signal.



Audio Track

-
- 5 If you're routing the M50's audio signal to an audio track, arm the REC button on so that you can hear/monitor the audio signal.
If you are routing the M50's audio signal to an AUX input track, this setting is not necessary.

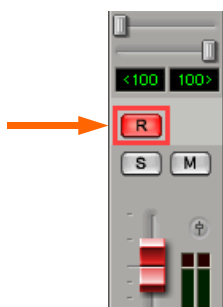

Audio Track

Other host applications

- 1 Start up your host application.
- 2 Start up "M50 Plug-In Editor" as a plug-in instrument.
- 3 Create a MIDI track. Choose "M50 Plug-In Editor" as the output of that MIDI track.
- 4 To route the M50's audio signal to your host application, create an audio track. On the input section of that audio track, select the input that you connected the M50's audio signal to.
- 5 Enable the monitor function on the audio track that will be receiving the audio signal from the M50.

Note: The instructions given here for "Other host applications" may not necessary be appropriate for setting-up all host applications. Please refer to the instructions for a host application that has a similar structure to the host application you're using, and always refer to the owner's manual for the specific host application that you are using.

About MIDI timing

If you experience irregularities in MIDI timing, please adjust the settings so that MIDI messages are sent directly to the M50 rather than being routed through the M50 Plug-In Editor. In this case, select the M50's SOUND port as the MIDI OUT destination of the MIDI track in your host application, so that the MIDI messages will be sent directly to the M50.

Note: For details on how to create a MIDI track and specify the MIDI OUT destination for that MIDI track, refer to the host application's owner's manual.

Basic functions and operation

Start-up

M50 Editor

- From the “KORG”-“M50” folder, start up “M50 Editor.”

Note: When you start up the editor, the M50 programs and other settings can be loaded automatically. (See p.27 “Software Setup (Initial settings for M50 Editor)”)

 Don't touch the keyboard or the mouse of your computer while data is being sent or received.

Windows XP / Windows Vista

Access the “KORG” folder from the taskbar via [Start] – [All Programs].

Mac OS X

The “KORG” folder is located in the “Applications” folder.

M50 Plug-In Editor

For details on starting-up the M50 Plug-In Editor, refer to the section for your host application in “Setting up the M50 Plug-In Editor” (p.8).

Note: When you start up the editor, the M50 programs and other settings can be loaded automatically. (p.27 “Software Setup (Initial settings for M50 Editor)”)

 Don't touch the keyboard or the mouse of your computer while data is being sent or received.

About the Preload data

Start up M50 Editor, and execute Receive All to load all data into M50 Editor. Then save this data to a file as preload data.

You can now create a setting for this data file to be automatically loaded when you start up M50 Editor, the start-up time will be shortened because you won't need to load the data from the M50. (p.27 “Software Setup (Initial settings for M50 Editor)”)

Items in the screen

A screen like the following will appear when you start up the editor. (This illustration here shows the Combination mode screen.)



Connection indicator (KORG logo)

This indicates the connection status between the M50 Editor/M50 Plug-In Editor and the M50.

- Lit



The M50 Editor/M50 Plug-In Editor and the M50 are connected via MIDI.

- Dark



The M50 Editor/M50 Plug-In Editor is not connected to the M50.

Mode (COMBI, PROG, SEQ, GLOBAL) / Browser (BROWSE) / Utility (UTILITY):

Here you can select program, combination, sequencer, or global mode. The browser will display the names of the programs, combinations, and songs that are in the M50. UTILITY lets you view and execute the utility commands that are available for the page you've selected.

This is where you can write (save) data.

Program (Combination/Song) Number, Name:

This area shows the number and name of the program, combination, or song. Use the up/down arrows at the right side to change programs, combinations, or songs.

Edit Pages, Tabs:

These are used to select the page that you want to edit.

Control Assign:

Here you can change the function of the four control surface knobs.

Control Surface:

Here you can control the tone, volume, or arpeggiator settings depending on the currently selected control assign functions.

ARP / Drum Track:

Here you can make settings for the arpeggiator function and the drum track

Keyboard:

This section consists of an 88-note keyboard, a pitch bend wheel, and a modulation wheel.

You can click the keyboard to play notes, and even play a glissando by dragging over the keyboard to the left or right. You can operate the pitch bend wheel and modulation wheel by dragging them upward or downward.

Operating procedure

Selecting a mode

Click the button to select the corresponding mode.

COMBI: Select, play, and edit combinations.

PROG: play, and edit programs.

SEQ: Select, play, and edit sequencer songs.

GLOBAL: Edit the software setup, global settings, MIDI settings, controller CC assignments, scale, category names, drum kits, and arpeggio patterns.

Selecting programs, combinations, and songs

- Click the [BROWSE] button to display the sound list, and then select a program (or combination or song). The items you can select will depend on the mode.
- Depending on whether you choose Category Select or Bank Select, the programs (or combinations) in the sound list will be arranged by category or by bank.

Auditioning programs, and selecting a program to edit

- 1* Click the [PROG] mode button to enter Program mode.
- 2* Click the [BROWSE] button to view the program list.
- 3* Click any program to select it. Play the keyboard of the M50 and you will hear that program.
- 4* When you've decided on a program to edit, click the [OK] button to load that program

Editor operations

- 1 Select Program mode, and click the Editor Pages [PLAY] tab to access the Play page.
- 2 At the left side of the control surface located at the top of the screen, click the [RTC] selector, and choose A for the A/B selector below it.
The indications of the four knobs will be [CUTOFF], [RESONANCE], [EG INTENSITY], and [EG RELEASE].
- 3 In the set of tabs located in the center of the screen, choose [OSC Mixer/ARP].



- 4 Use the four knobs of the control surface to vary the sound. Using the mouse to move the on-screen knobs will have the same result as turning the four knobs on the M50 itself. For an explanation of these parameters, please refer to the M50 parameter guide (PDF).
- 5 Next, choose the [ARP] selector located to the left of the control surface so that you can control the arpeggiator.
Now the four knobs will control the arpeggiator.
- 6 To the left of the control assign selectors, turn on the ARP ON/OFF button and DRUM ON/OFF button, and play the keyboard; a performance generated by the arpeggio function and the drum track will begin playing. To change the drum pattern that is playing, change the Pattern No. on the Basic/Drum Track page. To change the arpeggio pattern, change the Pattern on the Basic/ARP page.
- 7 While letting the arpeggiator play, move the four knobs or the knobs of the M50 itself, and notice how the arpeggio changes.
- 8 The upper part of the Play page shows the current values of the most important parameters for Program mode. This overview area shows the parameters organized by section. By clicking a section name (such as “Pitch EG” or “Filter1 EG”) you can jump automatically to the page/tab for editing the corresponding parameters.

Selecting pages and tabs

When you want to perform detailed editing, you can switch to other pages and tabs to access the desired parameters.

Global mode is divided into separate pages where you can edit drum kits, category names, and scales (temperaments). Select the desired page (or tab), and proceed to edit the settings.

- To select a page, click the tab for the desired edit page.
- To move between tabs within a page, select one of the tabs located in the center of the window.



Selecting a parameter and editing the value

- Use the mouse to edit the items in the display

For example you can change the shape of the EG by using the mouse to drag the rectangles shown in the EG graphic.

Note: For details on the parameters, please refer to the included “Parameter guide” (PDF version).

Selecting and executing utility functions

The utility functions are various commands available in each page. The available utility commands will differ depending on the page. These commands also let you save or load the edited or created data on your computer, and also allow you to import system exclusive data. Click the [UTILITY] button and choose a command from the menu that appears.

Note: For details on utility commands that are specific to the editor, refer to “Functions provided by the M50” (p.24).

1 From the [UTILITY] button, choose the command that you want to execute.

2 Make the necessary settings, and click OK to execute.

Writing (saving)

If you want to keep any of the edits you have made, you must write (save) them.

 The Write operation will save the edited settings on the M50.

If you select another program or close the application before you execute the Write operation, the content you had been editing will be lost. The same applies to combinations or songs.

Global mode settings are maintained until you close the application, but your changes will be lost when you close the application. If you click the [DUMP] button located in the upper right of each page in Global mode, the current settings will be saved in the M50. (Some pages do not have the [DUMP] button.)

As an example, here's how to write a program that you've edited in Program mode.

1 Click [UTILITY] to access the utility menu.

2 From the menu list, choose [Write Program].

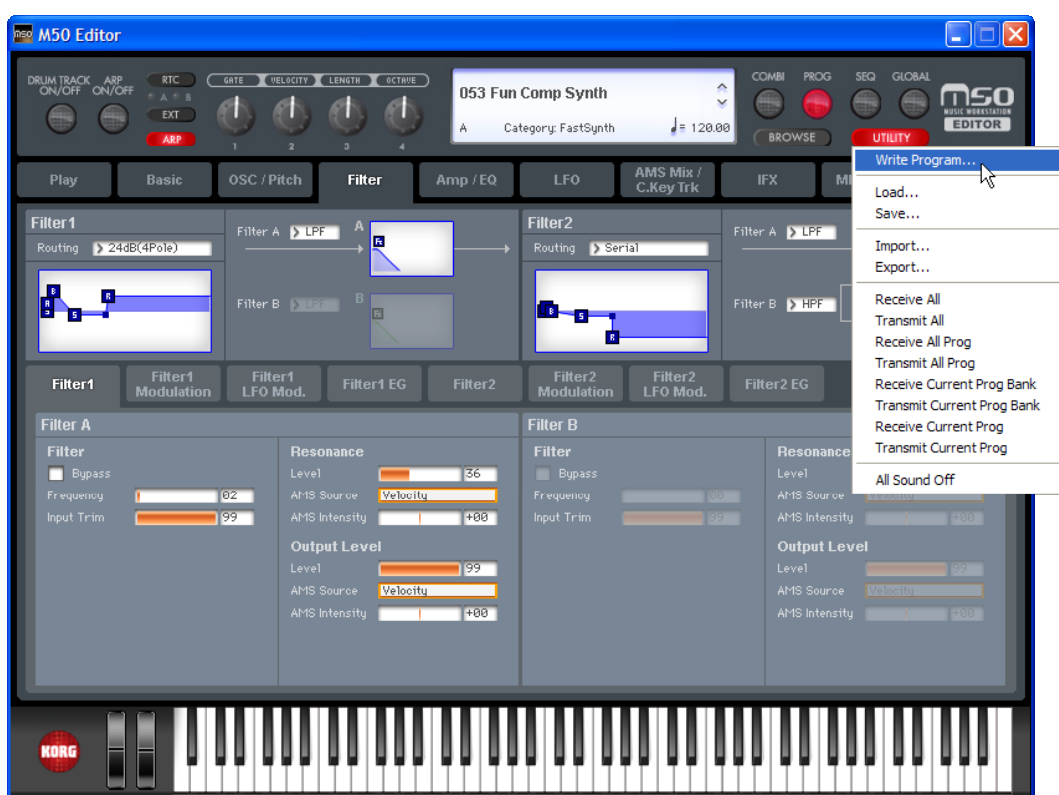

3 Specify the program name, category, and save destination, and click the [OK] button.

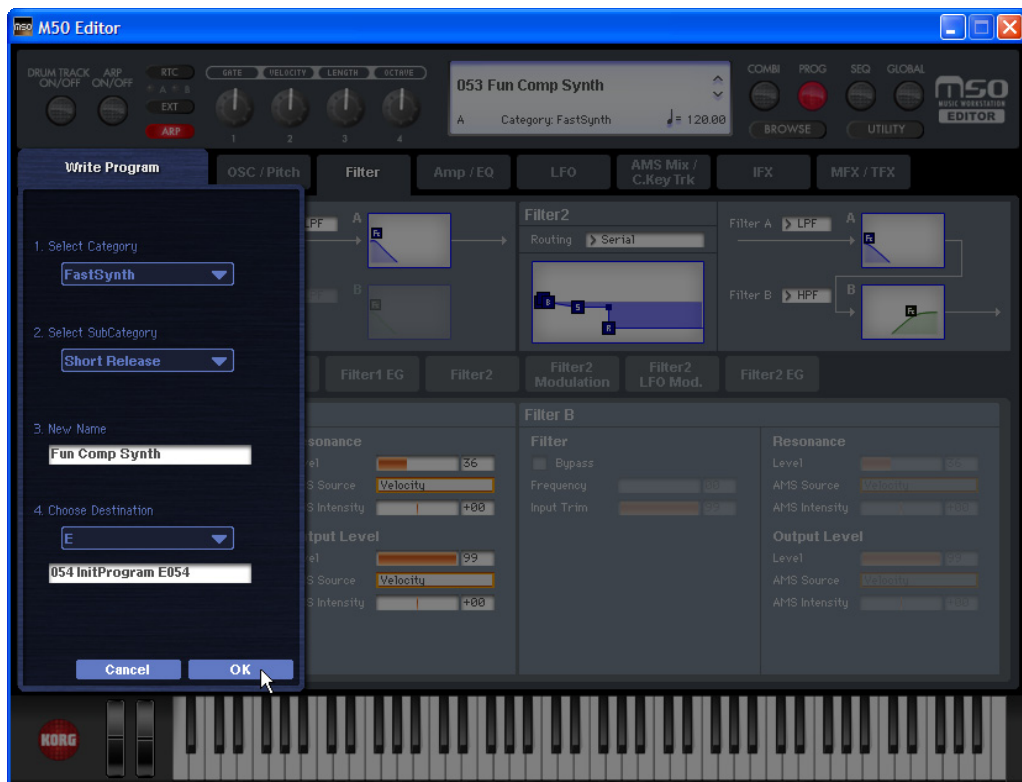

Note: If you execute a menu command (such as Swap Oscillator) on the M50 itself, the data in the Editor and the data in the M50 may lose synchronization. In this case, execute a UTILITY menu command (such as Receive Current Prog) in the Editor to receive a data dump of the current data.

Functions provided by the M50

1 Tone Adjust

This function provides an easy way to edit the sound of programs, the programs used within a combination, or the programs used by song tracks in a sequence. In the M50 Editor you can perform the same Tone Adjust operations as you can from the M50 itself.

2 Arpeggiator

The arpeggiator is a function that automatically produces arpeggios (broken chords). The M50 Editor lets you edit the parameters of the M50's (maximum of) two arpeggiators in each mode (PROG, COMBI, SEQ), edit arpeggio patterns in GLOBAL mode, and also to view the settings of the four knobs in real time. The arpeggio pattern edit screen lets you edit the arpeggio pattern while you listen to the phrase.



3 Drum Track

The Drum Track is a pattern sequencer dedicated to playing drum patterns. You can use it in any mode: Program, Combination, or Sequencer. In the M50 Editor you can turn the drum performance on/off, select drum patterns, select drum programs, and edit the settings of the assigned timbre – all in realtime.

Functions specific to the editor

These are functions that are not found on the M50, and are available only from the editor (M50 Editor, M50 Plug-In Editor).

Utility commands

Load

Loads editor data that was previously saved on the computer.

Save

Saves data from the editor to your computer as a file.

Note: These functions load or save the data as dedicated files for the editor application.

Receive All

Receives all data from the M50 data into the editor.

Note: The sequencer performance data of Sequencer mode is excepted.

Transmit All

Transmits all data in the editor to the M50 and writes it into internal memory.

Receive All Combi/Current Combi Bank

Receive All Prog/Current Prog Bank

Receive SEQ

Receive Global Data/Drum Kit/Arpeggio Pattern

Receive the corresponding data from the M50 into the editor.

Transmit All Combi/Current Combi Bank

Transmit All Prog/Current Prog Bank

Transmit SEQ

Transmit Global Data/Drum Kit/Arpeggio Pattern

Transmit the corresponding data from the editor to the M50 and writes it.

Receive Current Combi/Current Prog/1 SEQ/Current Arpeggio Pattern

Receive the respective data from the M50 into the editor.

Transmit Current Combi/Current Prog/1 SEQ/Current Arpeggio Pattern

Transmit the respective data from the editor to the M50.

Note: These Receive and Transmit commands use KORG SysEx MIDI Dump to send or receive data, or to synchronize the data between the M50 and the software.

 Don't touch the keyboard or the mouse of your computer while data is being sent or received. Also, don't touch the panel switches or the keyboard of the M50.

Import

Loads PCG data from the M50 into the editor.

PCG data from the M3 or data that was created in M3 Editor can also be converted and loaded into the editor. (Not all data is necessarily compatible.)

Export

Data created in the M50 Editor can be saved as PCG data for the M50.

Save as Default

Writes (saves) the global mode Software Setup settings of the editor as the default settings that will be used when you start up the editor.

Note: These utilities can be selected only in the editor's global mode Software Setup page.

Select Auto Load File

In the Software Setup tab, use "Load data file automatically" to select the desired file.

Note: Refer to "Load data file automatically".

All Sound Off

Depending on the host application, "hung" notes may occur while operating the host's functions. If this symptom occurs, please execute the "All Sound Off" command.

Software Setup (Initial settings for M50 Editor)

Global mode Software Setup lets you specify the default settings that the M50 Editor will use when it starts up. This setting is saved when you execute the UTILITY command Save as Default, and will be remembered the next time you start up.

Total Recall & Data Sync Settings

Total Recall & Data Sync Settings	
<input type="checkbox"/> ALL	
<input checked="" type="checkbox"/> PROG	<input checked="" type="checkbox"/> COMBI
<input checked="" type="checkbox"/> A	<input checked="" type="checkbox"/> A
<input checked="" type="checkbox"/> B	<input checked="" type="checkbox"/> B
<input checked="" type="checkbox"/> C	<input checked="" type="checkbox"/> C
<input type="checkbox"/> D	<input type="checkbox"/> D
<input type="checkbox"/> E	
<input checked="" type="checkbox"/> SEQ	
<input checked="" type="checkbox"/> Drum Kit	
<input checked="" type="checkbox"/> Arpeggio Pattern	

Here you can specify the editor data that will be saved and loaded as part of the song data by your DAW software. This setting lets you save only the data you need. When the M50 Editor starts up, the types of data that you've checked here will also be loaded automatically from the M50 that's connected to your computer. (In other words, this data will be synchronized.)

Since a data dump requires a certain amount of time, you may wish to shorten the startup time by using the Load Data File Automatically function instead of this function, or by using the UTILITY command Load to load a previously-saved data file into the M50 Editor.

Load data file automatically

Auto Load File
<input checked="" type="checkbox"/> Load data file automatically at starting up
Data file: C:\Program Files\KORG\M50\PRELOAD.M50a11

When the M50 Editor starts up, the data file you specify here will automatically be loaded into the editor. After this process is completed, the data you checked in Total Recall & Data Sync Setting will be loaded via data dump.

Auto Local Control

Local Control
<input checked="" type="checkbox"/> Auto Local Control

This setting automatically sets the M50's Local Control setting to the appropriate state when you start up the editor. We recommend that you normally leave this parameter on. The M50's Local Control setting will be reset to its original state when you close the editor.

MIDI Settings

MIDI Settings
MIDI IN Port: M50 1 KEYBOARD
MIDI OUT Port: M50 1 SOUND
<input type="checkbox"/> Send M50's MIDI Out data to the host application (VST Plug-In only)

Here you can adjust settings for MIDI connections between the M50 Editor and the M50.

MIDI IN Port / MIDI OUT Port

This selects the connection port for the M50 and M50 Editor. The name of the currently connected

MIDI port is shown. You won't need to change this setting if the M50 and the M50 Editor are connected correctly, since the M50 Editor will search for the M50 when it starts up, and will specify the MIDI port automatically.

Send M50's MIDI Out data to the host application (VST Plug-In Only)

If you turn this option on, the MIDI OUT data of the M50 itself will be sent to the host application as the output of the plug-in instrument.

Short messages are the only type of MIDI messages that can be output. If you're using a host application that is able to receive the MIDI data sent by a plug-in instrument, the MIDI messages generated by the M50's arpeggiator function can be sent to the MIDI track of a different software synthesizer.

Cautions

USB connection

If you lose data synchronization with the M50 when starting up the editor, please check the following points.

- If you're using USB-MIDI, you must use the KORG USB-MIDI Driver. The default driver provided by the operating system may have an extremely slow data transfer rate, or may not communicate correctly.
- If you're using a USB hub, try connecting the M50 directly to a USB port on the computer itself to see whether it will work. You can also try removing all other connected USB devices except for the M50 itself.

When you lose data synchronization, please perform the "Receive All" or "Transmit All" function in the Editor's "UTILITY" menu in order to synchronize the data between the editor and the hardware.

About the USB port to which you connect the M50 (Windows only)

- The M50's USB port is USB 1.1, but if the USB port of your computer itself supports USB 2.0, you may be able to increase the USB data transmission rate depending on how you make connections.

In some cases, connecting the M50 directly to a USB port of the computer itself may slow down the data transfer speed. If so, connect the M50 via a USB 2.0 hub rather than directly to the computer. This may increase the USB data transfer speed.

