

FOR MODELS:

SHI

4302 4306
6802 6805
6806

SHU

3002 3006
3012 3016
4002 4006
4016 4022
4026 4036
4302 4306
4312 4316
5302 5304
5305 5306
5312 5314
5315 5316
6802 6805
6806

SHV

4303 4803

BOSCH

Dishwasher Repair Manual

Effective: December 1, 1998

1st Edition/Rev. 0



BSH Home Appliances
2800 South 25th Avenue
Broadview, Illinois 60153

Introduction

This Repair Manual is designed to assist you in the evaluation, diagnosis and repair of the current SHI, SHU and SHV model dishwasher series. To better understand these appliances, their operation and construction we suggest that you read this manual thoroughly before attempting any repairs.

Table of Contents

Description	Page
Section 1	3
Warranty / Technical Specifications	4
Model / Serial Number Location	5
Product Overview	6 – 7
Notes	8
Section 2	9
Operation, SHU 3002 / 3006 / 3012 / 3016 / 4002 / 4006 / 4016 / 4022 / 4026 / 4036 ..	10
Cycle Chart	11
Operation, SHI 4302 / 4306 – SHU 4302 / 4306 / 4312 / 4316	12
Cycle Chart	13
Operation, SHU 5302 / 5304 / 5305 / 5306 / 5312 / 5314 / 5315 / 5316	14
Cycle Chart	15
Operation, SHI / SHU 6802 / 6805 / 6806	16
Cycle Chart	17
Notes	18
Section 3	19
Rack System	20 – 21
Interior Features	22 – 25
Detergent / Rinse-Agent Dispenser	26
Washability / Drying	27
SERVICE REMINDER	28
Section 4	29
Outer Door Removal	30
Door Components	31
Dispenser Operation	32
Dispenser Removal	33
Facia Assembly	34 – 35
Notes	36
Section 5	37
Base Components – Front Accessible: Electrical Connection	38
Circulation Motor Capacitor	38
Leveling Legs	39
Water Valve	39
Drain Motor	40 – 41

Table of Contents

SERVICE REMINDER	42
Description	Page
Section 6	43
Left Side Access	44
Left Side Components	45
Water Inlet / Discharge System – Operation	46 – 47
Water Inlet / Discharge System – Removal	48
Section 7	49
Right Side Access	50
Right Side Components	51
NTC Operation	52
NTC Removal	53 – 57
Notes	58
Section 8	59
Tank Removal	60 – 62
Base Components	63
Circulation Pump / Motor Removal	64
Circulation Pump / Motor Assembly	65
Heater Assembly Removal	66
Heater Assembly	67
Aqua Sensor	68
Door Spring Removal	69
Notes	70
Section 9	71
Wiring Diagrams / Schematics	72 – 84
Test Program	Diagram 1
SHI 4302 / 4306	Diagrams 1, 8, 9
SHI 6802 / 6805 / 6806	Diagrams 1, 8, 11
SHU 3002 / 3006 / 3012 / 3016	Diagrams 2, 3, 4
SHU 4002 / 4006 / 4016 / 4022 / 4026 / 4036	Diagrams 5, 6, 7
SHU 4302 / 4306 / 4312 / 4316	Diagrams 1, 8, 9
SHU 5302 / 5304 / 5305 / 5306 / 5312 / 5314 / 5315 / 5316	Diagrams 1, 8, 10
SHU 6802 / 6805 / 6806	Diagrams 1, 8, 11
SHV 4303 / 4803	Diagrams 12, 13

Section 1

Description	Page
Warranty / Technical Specifications	4
Model / Serial Number Location	5
Product Overview	6 – 7
Notes	8

Warranty / Technical Specifications

Warranty

1 st Year	Parts & Labor.
2 nd Year	Parts only.
3 rd – 5 th Year	Electronic Boards, parts only.
3 rd – 5 th Year	Racks, parts only.
	This does not include rack wheels; silverware baskets or plastic shelving.

Lifetime Stainless Steel.

Must receive a special authorization before attempting any repairs or replacement.

Cosmetic items, Facia and Door Panels are only warranted against manufacturing defects. In the event of a scratch or dent have the customer contact the Customer Service Department.

CUSTOMER SERVICE 800-944-2904

TECHNICAL SERVICE 888-522-6724

Technical Specifications

Electrical Requirements

Rating	120V / 60Hz
Dedicated Circuit	15 Amp
Total Amps (load rated)	11 Amp

Water Supply

Suggested Incoming Temp.	140° f
PSI Min / Max	20 / 60
Water Connection	3/8" Copper or Flexible Stainless Steel

Component Values

Component	Ohms*	Amperage	Other
Water Valve	1K	–	–
Drain Motor	16	.75	–
Circulation Motor	10	1.25	–
NTC	55K at room temp. (75° f)	–	Resistance decreases as temperature increases
PTC (actuator)	200	–	–
Heater	10.5	9.75	1200 watts

*always disconnect both component leads before measuring for resistance.

Electrical Warning:

To avoid personal injury and/or property damage it is important that safe servicing practices and procedures are observed at all times. Disconnect the electrical service before attempting any repairs, and live tests are to be performed by experienced and qualified service personnel only.

Model / Serial Number Location



Fig. 1-1



Fig. 1-2

Located on the right hand side of the Inner Door is the Model and Serial number tag, Fig. 1-1. The Model and Serial numbers can be found on the left side of the tag within the black outline box, Fig. 1-2. The Model Number for this unit is SHU 5312 UC/U06.

Located just under the Model Number is the ten-digit Serial Number. The Serial Number for this unit is FD 7801 123456.

Service note: A second Model and Serial number tag is located on the Base, see Section 5, Fig. 10-1.

Product Overview

The Bosch dishwasher utilizes a two motor system with separate Circulation and Drain Motors, and a Flow Through Heater controlled by a Flow Switch and NTC Thermistor. With some models also having the advanced logic feature of an Aqua Sensor turbidity measuring device, Fig. 2-1.

- A two motor system allows each motor to be designed for a single function, thus reducing overall size and energy consumption. While also reducing operating noise.
- The Flow-Through Heater allows a shorter heating cycle since all water must pass through the Heater, increasing water temperature by approximately two degrees a minute. To protect the heater from dry fire, the Flow Switch will not allow the Heater to activate unless water is flowing.
- Water temperature is controlled by the NTC (negative temperature coefficient). As water temperature increases the NTC records the decrease in resistance. The Control Unit Logic Board measures this resistance change and allows the program to advance once the correct temperature (resistance level) is reached.
- The Aqua Sensor turbidity measuring device, which is available only on select models, evaluates the pre-wash water using a beam of light and a pick-up sensor. If the beam passes easily through the pre-wash water then no additional wash water is added. If the beam cannot pass through, then the pre-wash water is drained and a fresh fill is added for the main wash cycle.

The heated water then advances through the system via a four level wash system that uses both an upper and lower spray arm as well as an overhead sprayer, Fig. 2-2.

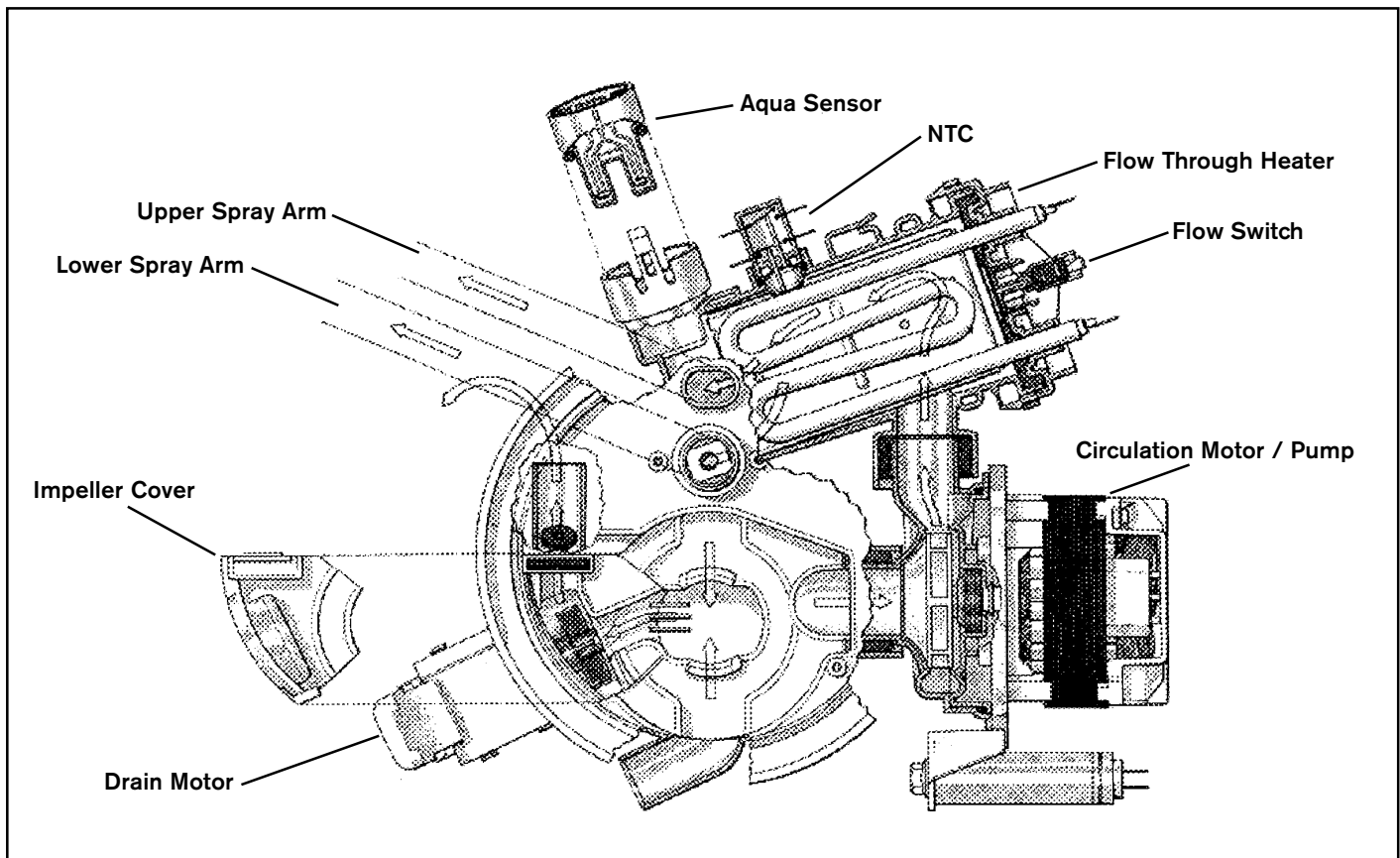

Fig. 2-1

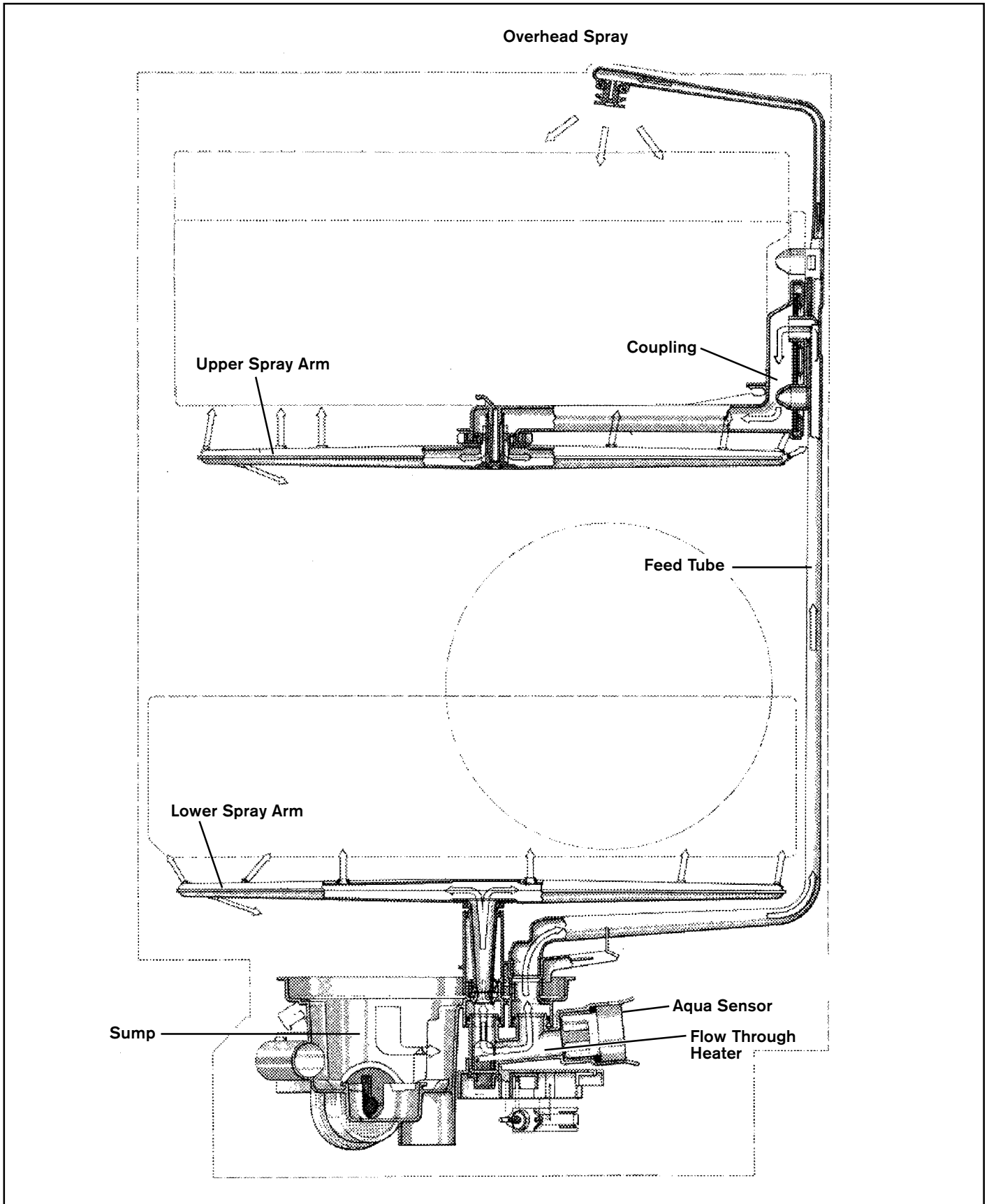

Fig. 2-2

Notes

Section 2

Description	Page
Operation, SHU 3002 / 3006 / 3012 / 3016 / 4002 / 4006 / 4016 / 4022 / 4026 / 4036	10
Cycle Chart	11
Operation, SHI 4302 / 4306	
SHU 4302 / 4306 / 4312 / 4316	12
Cycle Chart	13
Operation, SHU 5302 / 5304 / 5305 / 5306 / 5312 / 5314 / 5315 / 5316	14
Cycle Chart	15
Operation, SHI & SHU 6802 / 6805 / 6806	16
Cycle Chart	17
Notes	18

Operation

SHU 3002/3006/3012/3016/4002/4006/4016/4022/4026/4036

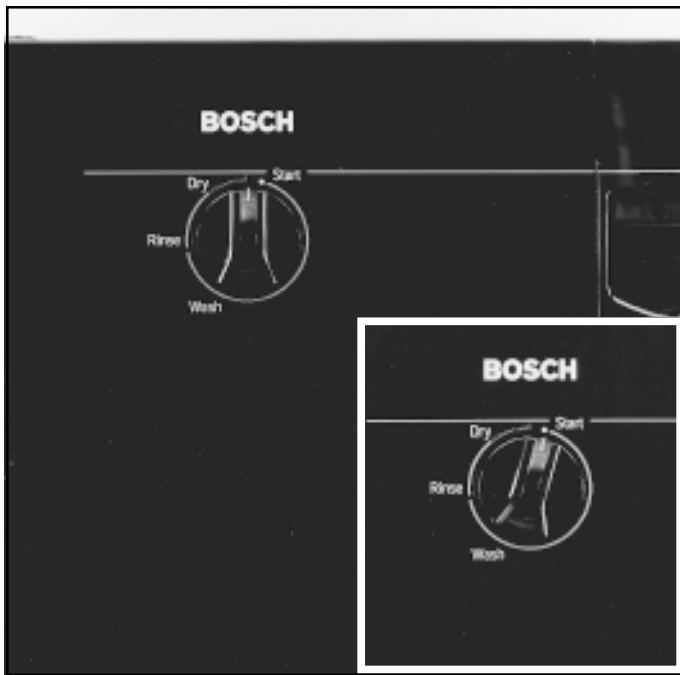

Fig. 3-1

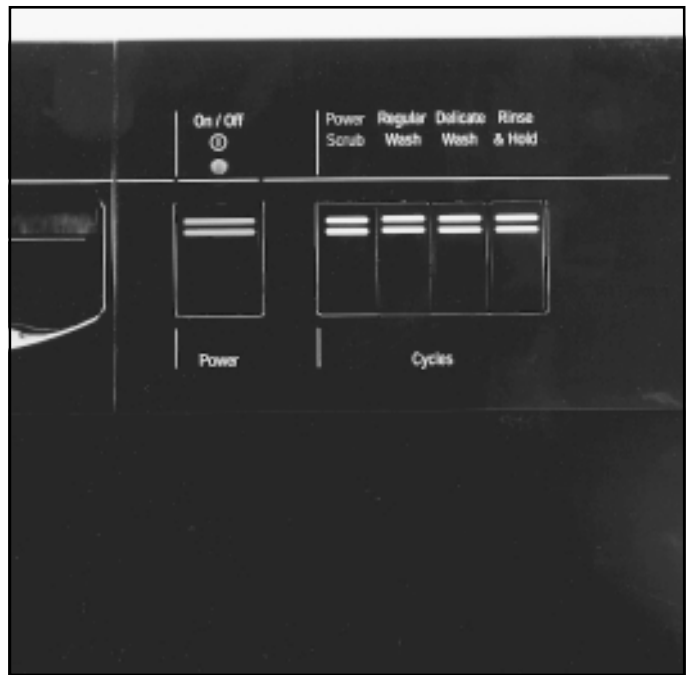

Fig. 3-2

The SHU 30** and 40** are both mechanical units that operate using a basic Timer and Selector Switch.

TO OPERATE EITHER MODEL, (a SHU 4006 is shown):

Fig. 3-2.

First select a cycle by pushing the corresponding Cycle Button in. The Cycle Button remains in the indented position until another cycle is chosen.

Now, depress the On/Off Button until it locks in place and the On LED illuminates.

Note: The On lamp will remain illuminated until the On/Off Button is depressed a second time turning the unit off.

If the door is opened during the cycle, the On/Off Button will be reset to off and must again be depressed to re-activate the unit.

Fig. 3-1.

Then, turn the Timer Knob slowly clockwise to the start position and release. You will hear the Drain Motor activate.

The Timer Knob will continue to advance clockwise back to the twelve O'clock position until the cycle is complete.

Please note: During the Rinse & Hold Cycle the Timer Knob will only advance to the two O'clock position and then stop, indicating the end of the Rinse & Hold cycle.

Cycle Chart

SHU 3002/3006/3012/3016/4002/4006/4016/4022/4026/4036

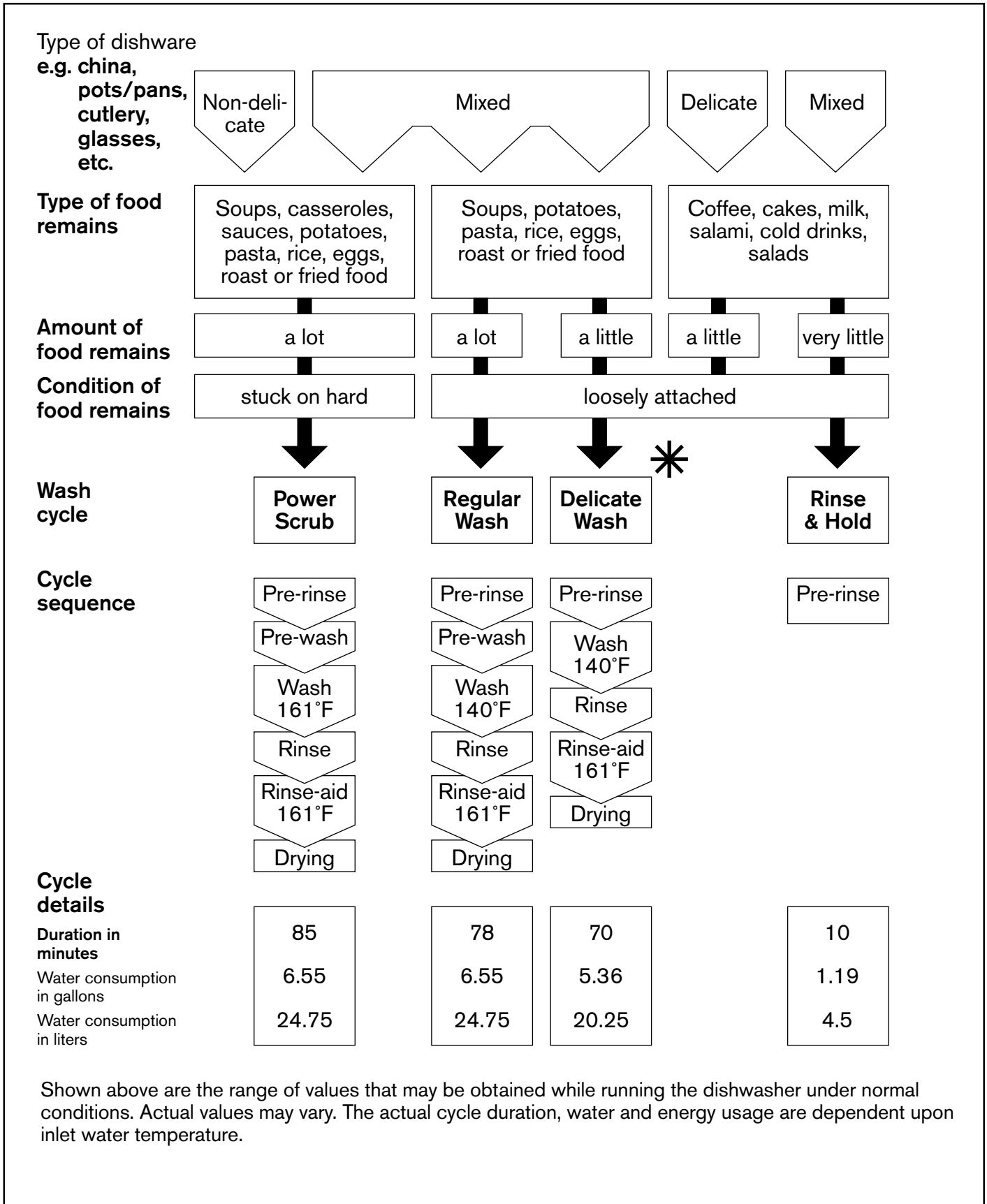

Shown above are the range of values that may be obtained while running the dishwasher under normal conditions. Actual values may vary. The actual cycle duration, water and energy usage are dependent upon inlet water temperature.

* Delicate cycle not used on SHU 3002/3006/3012/3016

Operation

SHI 4302/4306 SHU 4302/4306/4312/4316



Fig. 3-3



Fig. 3-4

The SHI or SHU 43** series operates using an electronic Control Unit.

TO OPERATE:

Fig. 3-3.

First depress the On/Off Button until it locks in place.

Fig. 3-4.

Once the On/Off Button is depressed the LED above the previously used cycle will illuminate.

To change the cycle, simply press the desired Cycle Button twice. The LED above that cycle will then illuminate.

As the program advances the Cycle Progress LED's will illuminate (wash, rinse / dry). When the cycle is complete the Clean LED will be illuminated.

TO CANCEL A CYCLE:

Press the Power Scrub Plus and Regular Wash Buttons both in at the same time. The unit will then drain and the Clean LED will illuminate.

Please note: If the door is opened during the cycle, the On/Off Button will be reset to off and must be depressed again to re-active the cycle. The cycle will resume from where it left off.

Cycle Chart

SHI 4302/4306 SHU 4302/4306/4312/4316

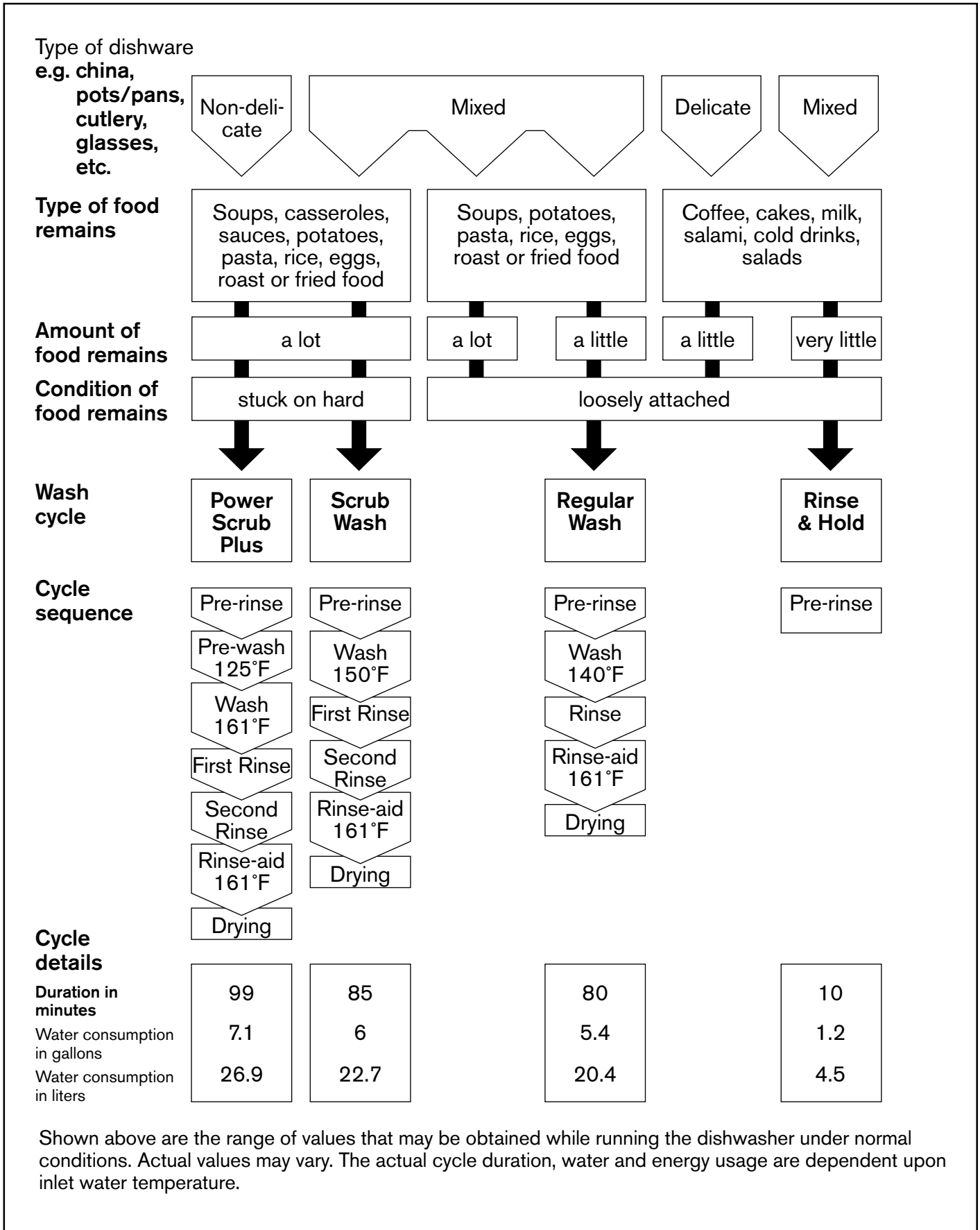

Operation

SHU 5302/5304/5305/5306/5312/5314/5315/5316



Fig. 3-5

The SHU 53** series operates using an electronic Control Unit.

TO OPERATE:

Fig. 3-5.

First depress the On/Off Button until it locks in place.

Fig. 3-6.

Once the On/Off Button is depressed the LED above the previously used cycle will illuminate. To change the cycle, simply press the desired Cycle Button twice. The LED above that cycle will then illuminate.

The Cycle Countdown will display an approximate run time for the cycle chosen. This run time will depend on incoming water temperature and the turbidity of the pre-wash water.

Note: It is normal for the Countdown Display to remain at a time increment for more than one minute, or skip a time increment depending on the calculations of the Control Unit.

Also, with continued use the Control Unit will learn the wash and temperature patterns for the most commonly used programs and will then reduce the overall start and running times.

At the end of the cycle the display will show a CL, indicating that the cycle is complete.

TO CANCEL A CYCLE:

Press the Scrub Wash and Delicate / Econo Buttons both in at the same time. The unit will then drain and the figure CL will appear in the display.

DELAY START:

The Delay Start feature allows the unit to be delayed for up to nine hours. To program, start the unit as described above, but after selecting a cycle push the Delay Start button. The display will show a 1h, or one-hour delay. Continue to depress the Delay Start Button until the desired delay time is reached (up to nine hours, 9h).

The unit will begin automatically once the delay time has elapsed. To reset the delay, press the Delay Start Button until it reaches 0h.

REFILL RINSE AGENT LED:

The Refill Rinse Agent LED is activated via a Reed Switch on the Detergent Dispenser, Section 4, Fig. 8-3. The LED will illuminate when the Rinse Agent Dispenser is empty.

Service note: The Refill Rinse Agent LED will also illuminate when the dishwasher door is opened and then closed even if the Dispenser is full, but will only remain lit for a few seconds.

"F" CODE:

An "F" in the display window indicates a filling fault, see Section 6, Fig. 12-1 through Fig.12-6.

Please note: If the door is opened during the cycle, the On/Off Button will be reset to off and must be depressed again to re-active the cycle. The cycle will resume from where it left off.

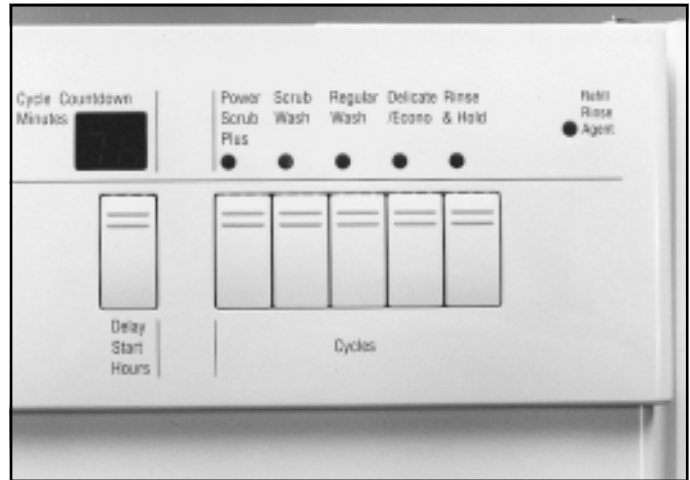
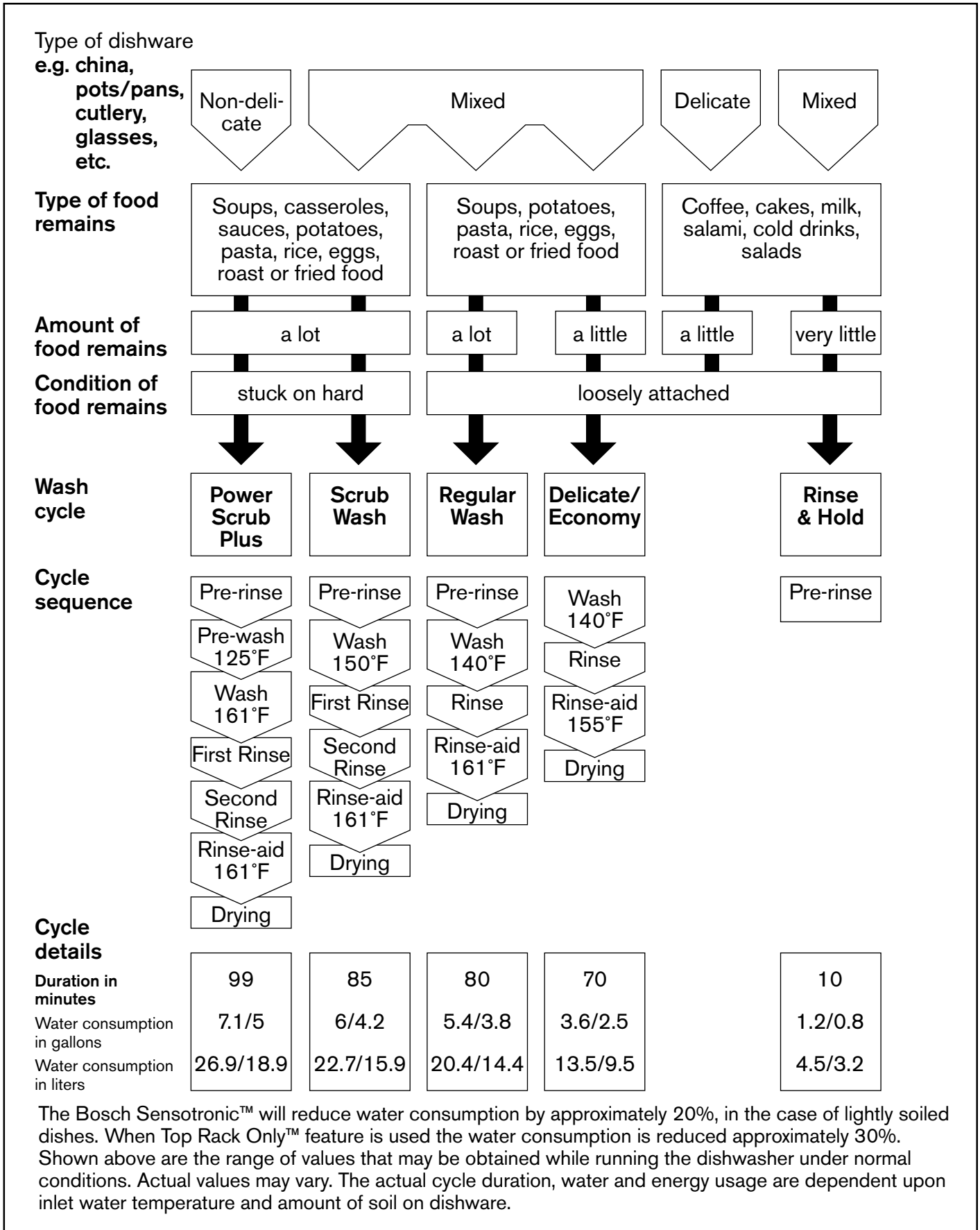

Fig. 3-6

Cycle Chart

SHU 5302/5304/5305/5306/5312/5314/5315/5316



Operation

SHI/SHU 6802/6805/6806



Fig. 3-7

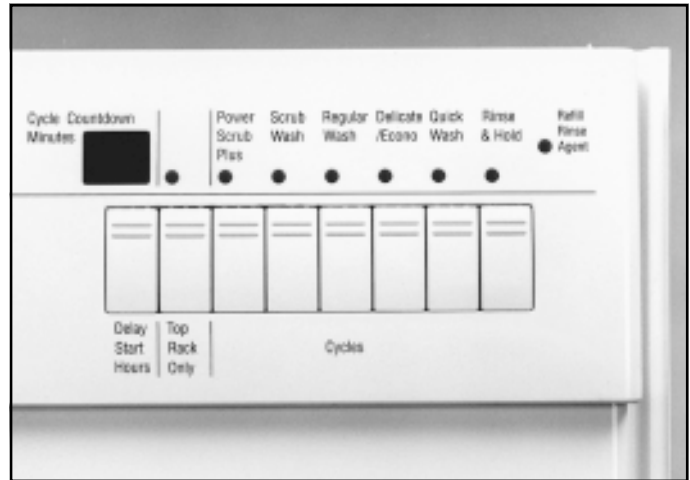

Fig. 3-8

The SHI / SHU 68** series operates using an electronic Control Unit.

TO OPERATE:

Fig. 3-7.

First depress the On/Off Button until it locks in place.

Fig. 3-8.

Once the On/Off Button is depressed the LED above the previously used cycle will illuminate. To change the cycle, simply press the desired Cycle Button twice. The LED above that cycle will then illuminate.

The Cycle Countdown will display an approximate run time for the cycle chosen. This run time will depend on incoming water temperature and the turbidity of the pre-wash water.

Note: It is normal for the Countdown Display to remain at a time increment for more than one minute, or skip a time increment depending on the calculations of the Control Unit.

Also, with continued use the Control Unit will learn the wash and temperature patterns for the most commonly used programs and will then reduce the overall start and running times.

At the end of the cycle the display will show a CL, indicating that the cycle is complete.

TO CANCEL A CYCLE:

Press the Scrub Wash and Delicate / Econo Buttons both in at the same time. The unit will then drain and the figure CL will appear in the display.

DELAY START:

The Delay Start feature allows the unit to be delayed for up to nine hours. To program, start the unit as described above, but after selecting a cycle push the Delay Start button. The display will show a 1h, or one-hour delay. Continue to depress the Delay Start Button until the desired delay time is reached (up to nine hours, 9h).

The unit will begin automatically once the delay time has elapsed. To reset the delay, press the Delay Start Button until it reaches 0h.

TOP RACK ONLY:

The Top Rack Only feature can be used in conjunction with any cycle. To active, press the Top Rack Only Button after selecting a cycle, the Top Rack Only LED will illuminate and all water will be diverted to the upper wash arm for the complete cycle.

REFILL RINSE AGENT LED:

The Refill Rinse Agent LED is activated via a Reed Switch on the Detergent Dispenser, Section 4, Fig. 8-3. The LED will illuminate when the Rinse Agent Dispenser is empty.

Service note: The Refill Rinse Agent LED will also illuminate when the dishwasher door is opened and then closed even if the Dispenser is full, but will only remain lit for a few seconds.

"F" CODE:

An "F" in the display window indicates a filling fault, see Section 6, Fig. 12-1 through Fig.12-6.

Please note: If the door is opened during the cycle, the On/Off Button will be reset to off and must be depressed again to re-activate the cycle. The cycle will resume from where it left off.

Cycle Chart
SHI/SHU 6802/6805/6806

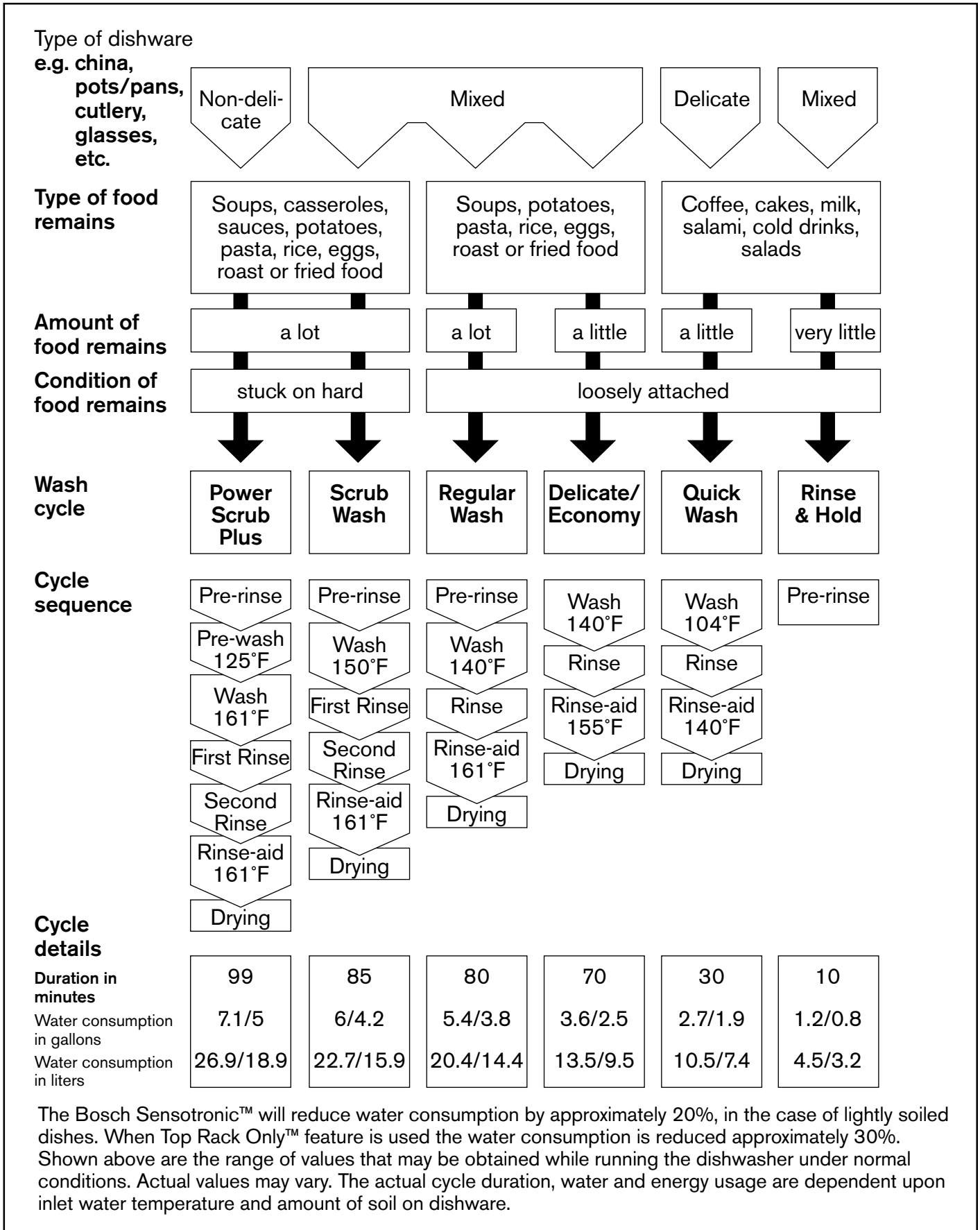

Notes

Section 3

Description	Page
Rack System	20 – 21
Interior Features	22 – 25
Detergent / Rinse-Agent Dispenser	26
Washability / Drying	27
Notes	28

Rack System

Rack configurations for individual dishwasher models will vary. However, all Racks are constructed from a steel wire grid with a gray nylon outer covering.

Note: Racks may discolor due to the water supply or types of food remaining on the dishes. We recommend that a vinegar wash be used to assist in removing these stains.

Start the unit, and let run approximately ten minutes, then pour in two cups of white vinegar and let the unit complete the cycle, repeat if necessary.



Fig. 4-1



Fig. 4-2

On select models the Upper Rack is height adjustable. To adjust rack height, or to remove the Rack from the unit.

Fully extend the Rack as shown in Fig. 4-2

Note how the Rack Rollers are designed to ride on the outside of the Rails for a smoother operation.



Fig. 4-3

With the Rack fully extended. Lift up on the Rack until the Front Rollers disengage from the Rail.

Now bring the Rack out further and allow the Rear Wheels to disengage.

Rollers: Rack Rollers are a press fit making for easy removal and replacement.

Rack System

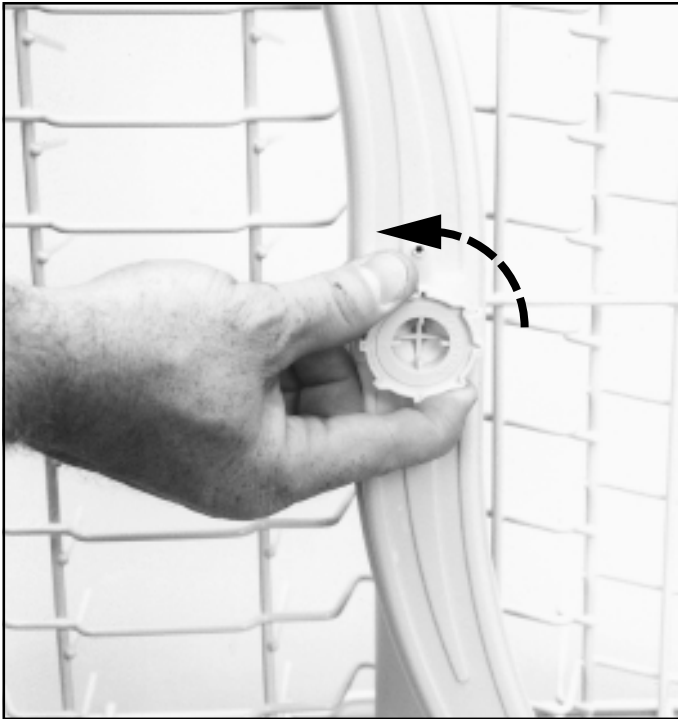

Fig. 4-4



Fig. 4-5

Attached to the Upper Rack is the Upper Spray Arm Assembly.

The Upper Spray Arm can be removed from the Upper Spray Arm Assembly for cleaning or replacement by turning the Arm Nut counter-clockwise, Fig. 4-4.

And then bringing the Arm down and off the Arm Assembly, Fig. 4-5.

Interior Features



Fig. 5-1

Interior features for all model dishwasher covered in this repair manual are identical. Those features include:

1. Strike Plate. The Strike Plate is in a fixed position and cannot be adjusted.
2. Upper Rack Rails and Guide Rollers.
3. Door Gasket
4. Lower Spray Arm
5. Filter Basket
6. Filter Screen
7. Feeder Tube Assembly

Interior Features



Fig. 5-2
The Upper Rack Rails are made of stainless steel with a plastic end cap.

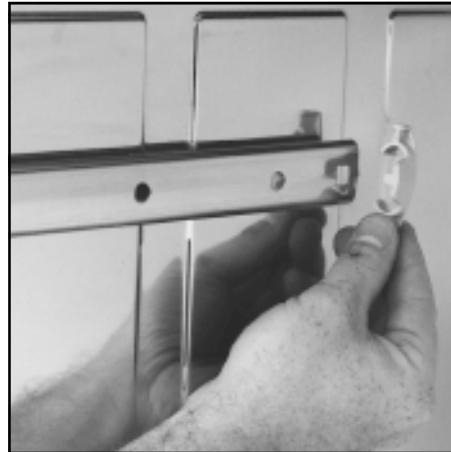

Fig. 5-3
To remove the Rail, disengage the End Cap by applying outward pressure to the Cap's top tab, unclipping it from the Rail. Then slide the Rail out from the Guide Rollers.



Fig. 5-4
The Upper Rack Guide Rollers are permanently attached to the Tank and cannot be removed or repaired.



Fig. 5-5
The Door Gasket is press fit into a channel molded around the Tank.



Fig. 5-6
To remove the Gasket, simply pull it away from the Tank Channel.

Note: Two inches of overlap are left at each end of the Gasket to insure a proper seal.

To replace, press the ribbed end firmly into the channel until secure. No sealant or glue is required.

Service tip: To test for a bad Door Gasket, open the dishwasher door and insert a dollar bill, then close the door and pull the bill out. If the bill is snug the Gasket is good, if the bill slides out easily the Door Gasket may need to be replaced.

Interior Features

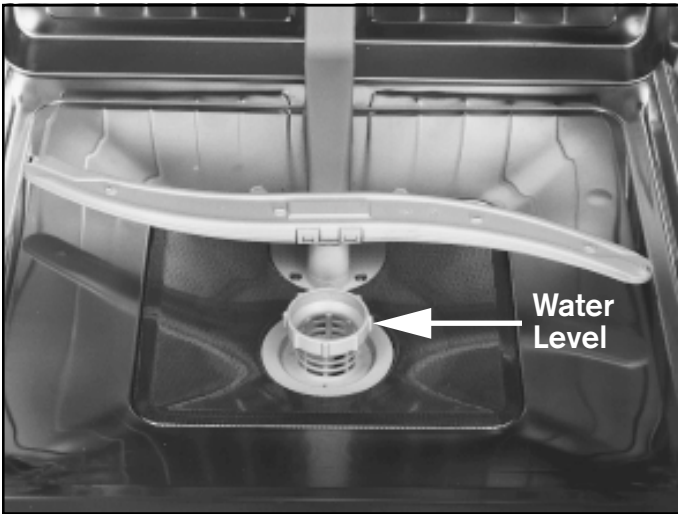

Fig. 5-7

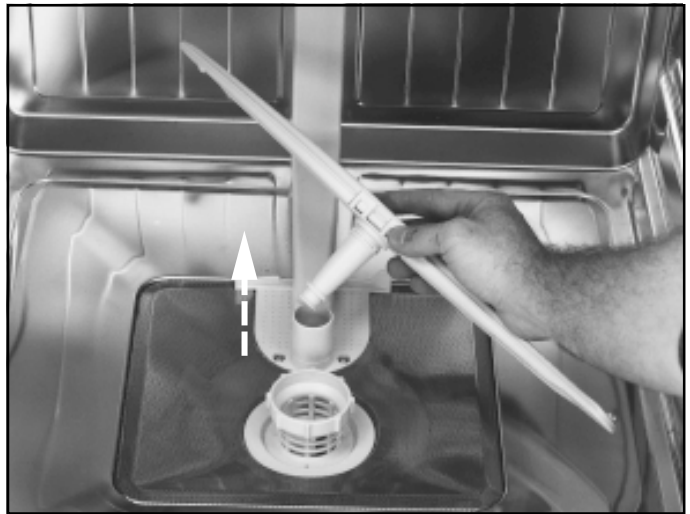

Fig. 5-8

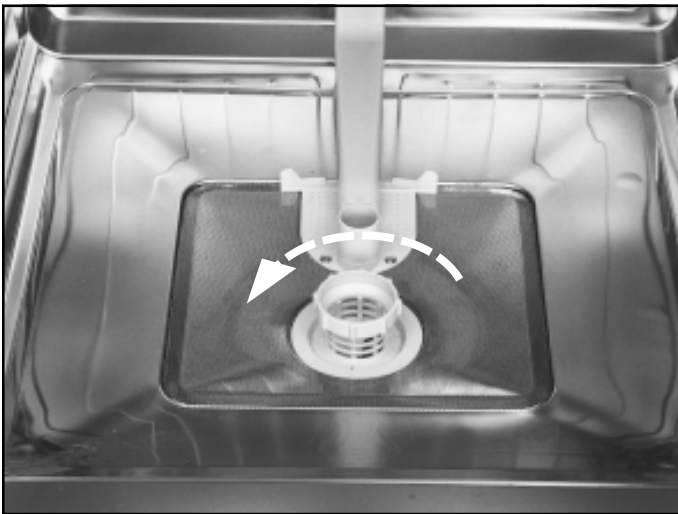

Fig. 5-9



Fig. 5-10



Fig. 5-11

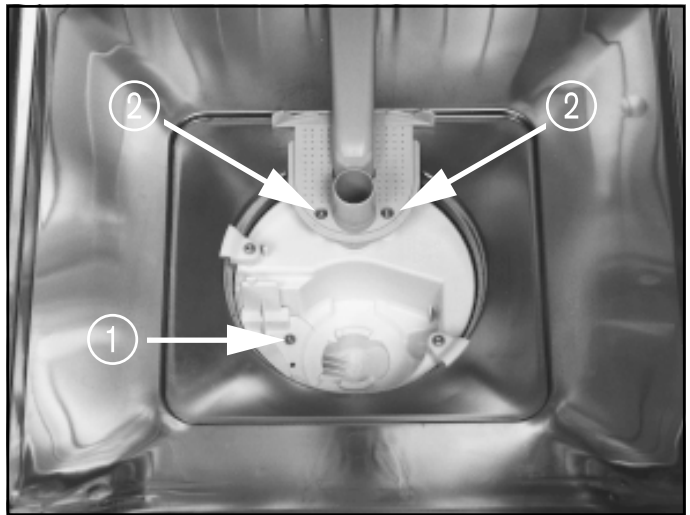

Fig. 5-12

Interior Features

Fig. 5-7 The operating water level of the dishwasher is at approximately the upper edge of the filter basket.

Fig. 5-8 The Lower Spray Arm is press fit into the Feeder Tube Socket.

To remove the Arm, grasp the Arm Hub and pull up until the Arm disengages from the Socket. The Arm or Arm Socket can now be checked for debris.

Fig. 5-9 The Filter Basket is removed by turning it ninety degrees counter-clockwise.

Fig. 5-10 Then lift it out for cleaning.

The Filter is a fine mesh of stainless steel and should be inspected and cleaned at least once a month.

Fig. 5-11 With the Filter Basket removed, the filter screen can then be lifted out.

The Filter Screen is also made of stainless steel, and was designed with rolled ends to eliminate sharp edges. It too should be inspected and cleaned at least once a month.

Fig. 5-12 With the Filter Screens removed you now have access to the sump area.

The Sump has a Drain Intake on the left, and the Circulation Pump Intake on the right.

A removable cover, item 1, hides the Drain Impeller. To remove the cover, remove the single T-20 Torx screw and then lift the cover off. You may now examine the Impeller for any obstructions.

The Feeder Tube Assembly allows water to flow to the Lower, then Upper Spray Arms and then to the Top Sprayer Head. It is replaced as a complete assembly by first removing the two T-20 Torx screws, item 2, at its base.

Then bring the tube up and off the Sump Housing, and remove it from the retaining clip located on the rear wall.

Detergent / Rinse-Agent Dispenser

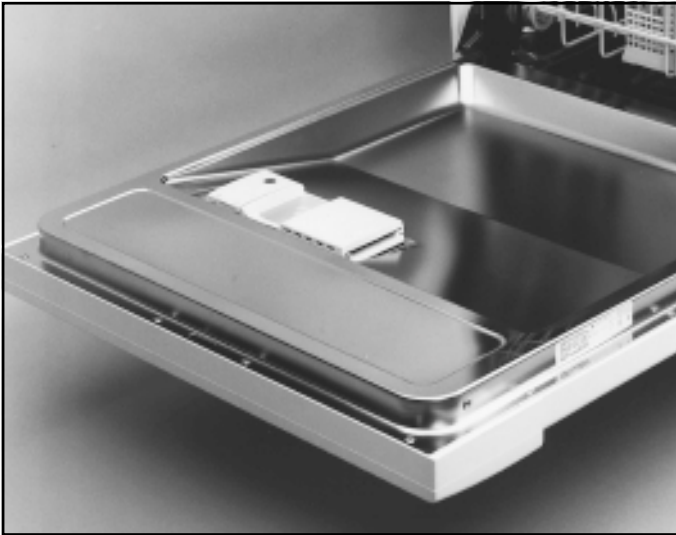

Fig. 6-1

Located on the Inner Door is the Detergent / Rinse Agent Dispenser, Fig. 6-1.

The Dispenser Housing is one assembly containing three individual components.

Rinse Agent Dispenser.

Detergent Cup.

Steam Vent.

Note: Mechanical operation and removal of the Dispenser is shown in Section 4.

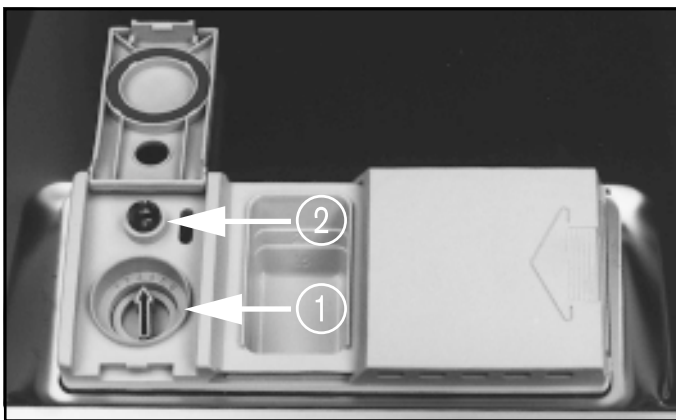

Fig. 6-2

To fill or adjust the Rinse Agent Dispenser, open the Rinse Agent Door by pulling up on the Door Latch.

The Dosage Meter, item 1, is now visible. The Dosage Meter allows you to adjust the amount of Rinse Agent dispensed into the rinse stage of the cycle. The factory setting is three.

There is also an eyepiece, item 2, that provides a visual indication as to the amount of Rinse Agent remaining in the Dispenser.

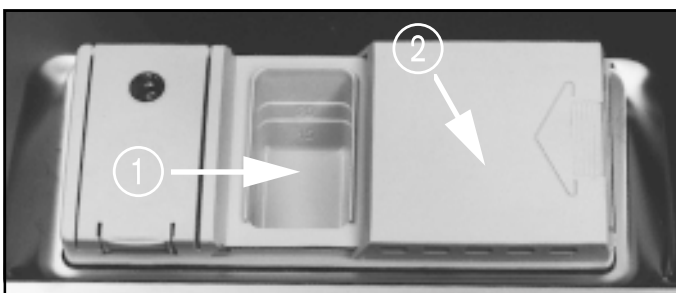

Fig. 6-3

To the right of the Rinse Agent Dispenser is the Detergent Cup, item 1.

Once detergent has been loaded into the cup, slide the Detergent Door, item 2, closed.

When the door is fully closed press down on the door end to lock it.

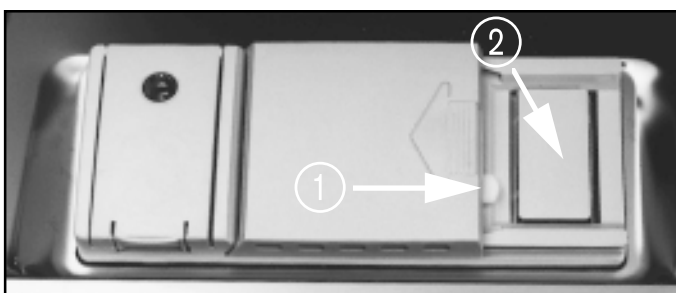

Fig. 6-4

A white Locking Lever, item 1, will then extend. Once closed, the detergent door may be released by pressing in on the Locking Lever.

With the Detergent Door closed the Steam Vent is now visible, item 2.

During the drying stage of the cycle, steam is drawn through the vent and collects in a Condensation Tube.

Washability / Drying

WASHABILITY

There are four factors that play a critical role in Washability: Time, Temperature, Water and Detergent. It is important when attempting to determine the cause of a Washability complaint that all four factors be considered and tested.

Time: The duration of the program is accurate (see cycle chart).

Temperature: The wash and rinse temperatures are within the desired range (see cycle chart).

Water: The unit is filling with the correct amount of water (Section 3, Fig.5-7)

Detergent: The detergent is fresh, and not being used in excessive amounts.

Please note: Other factors such as clean filters, a properly routed drain hose, water hardness and quality, as well as loading of items will also effect Washability.

DRYING

As part of an energy saving design Bosch Dishwashers do not activate the Heating Element during the Drying cycle. Instead, the dishwasher utilizes a rinse temperature of up to 161° Fahrenheit, and the addition of Rinse Agent to achieve a quality drying result.

HOW THIS SYSTEM FUNCTIONS:

During the rinse cycle water is heated to 161° Fahrenheit, this heat is transferred to the items in the dishwasher where it is absorb and stored.

During the drying portion of the cycle all dishwasher items will then radiate the stored heat, thus evaporating any water that has collected on the items surface, burning it off and converting the liquid into steam.

This process of “flash drying” is assisted by the release of Rinse Agent into the rinse water. Rinse Agent is a water softener that inhibits water from collecting or pooling, allowing it to be easily evaporated.

The remaining steam is vented from the interior through the Steam Vent (Fig. 6-4, item 2) where it is then collected by, and drained from the Condensation Tube (Section 4, Fig. 7-5, item 2).

Service note: When confronted with a drying complaint, make sure the Rinse Agent Dispenser is full, and the rinse water temperature is within the desired range. Please remember that the unit will not dry without Rinse Agent.

Service Reminder

From this point in the manual only the technical features and components of the SHU 5312 will be demonstrated.

However, due to the overwhelming similarities between the model SHU 5312 and the remaining Bosch Dishwasher line, you will be able to easily diagnose and repair all current Bosch model SHU, SHI and SHV Dishwashers.

Section 4

Description	Page
Outer Door Removal	30
Door Components	31
Dispenser Operation	32
Dispenser Removal	33
Facia Assembly	34 – 35
Notes	36

Outer Door Removal



Fig. 7-1

To remove the Outer Door, open the door and remove the six T-20 Torx screws located three on each side of the Inner Stainless Door, Fig. 7-1.

Return the door back to its upright position, and bring the bottom of the Door Panel out toward you, then slide the top of the panel down and out from under the Facia Panel, Fig. 7-2.

As the Outer Door is being removed, the left or right Door Guards may shift or fall out of place, Fig. 7-3.

To reposition them, slide them back in over the hinge, Fig. 7-4, lining up the door guard square tab with the hinge lever square notch.

Please note: Door Guards must be in place before reinstalling the Door Panel. Door Guards are not used on SHI or SHV models.



Fig. 7-2

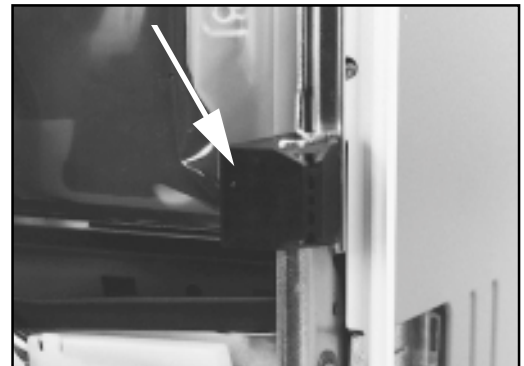

Fig. 7-3



Fig. 7-4

Door Components

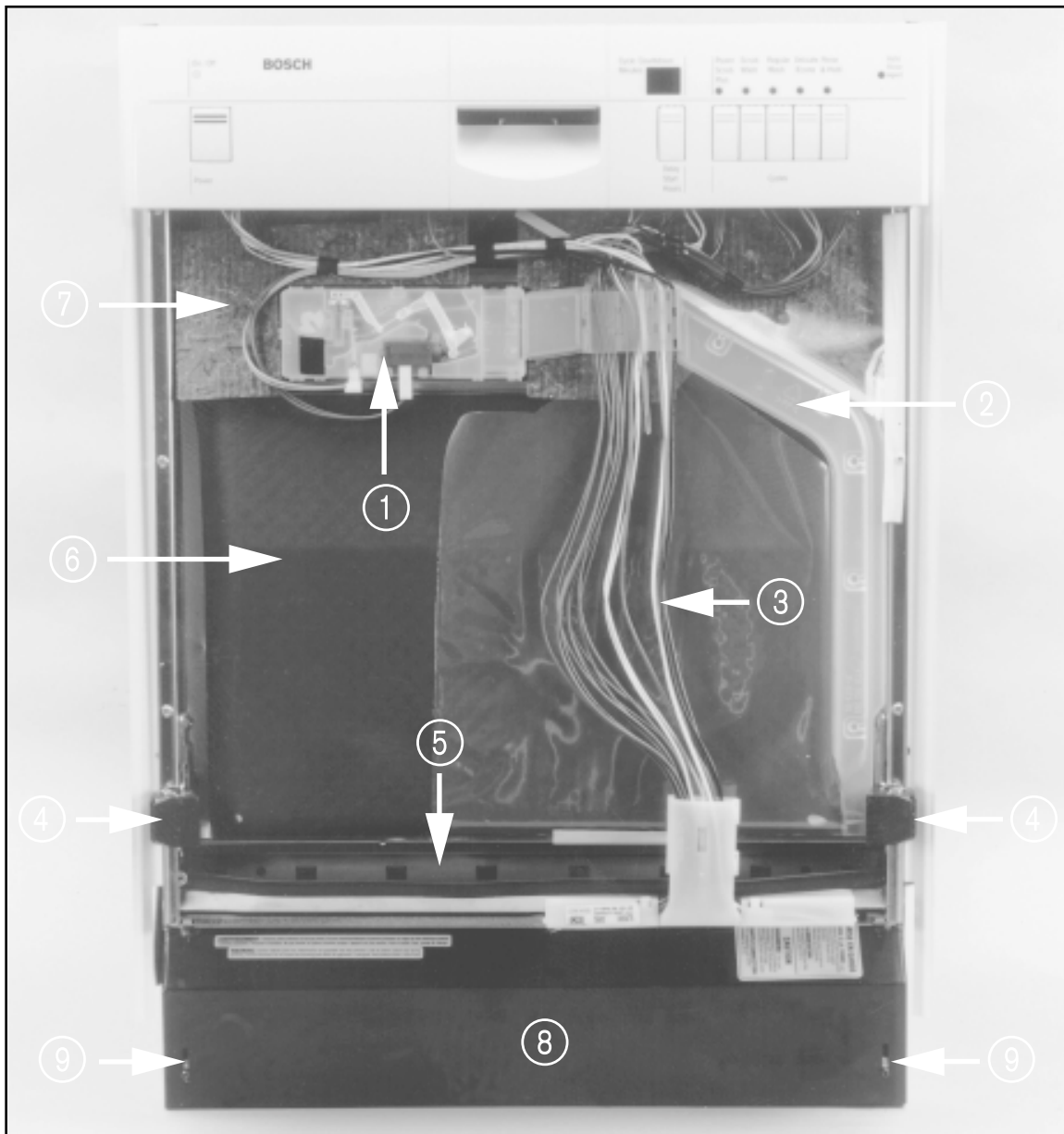

Fig. 7-5

Once the Outer Door has been removed the following components become visible.

1. Dispenser Assembly
2. Condensation Tube
3. Upper Wiring Harness
4. Door Guards
5. Door Seal
6. Bituminous Insulation
7. Cloth Fiber Insulation

Also note the Toe Kick, item 8, and the Toe Kick Mounting Screws, item 9.

Dispenser Operation

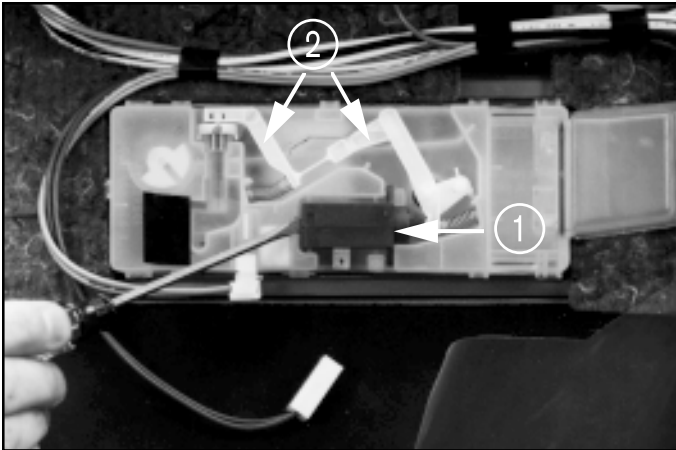

Fig. 8-1

The Dispenser Assembly operates via a PTC Actuator (wax motor), item 1.

When voltage is applied to the Actuator it advances a Combination Lever, item 2.

The Combination Lever allows the Soap Door to open, and later in the cycle dispenses the Rinse Agent.

To remove the Actuator, first disconnect the Wiring Connector. Then, using a small screwdriver, release the locking tab....

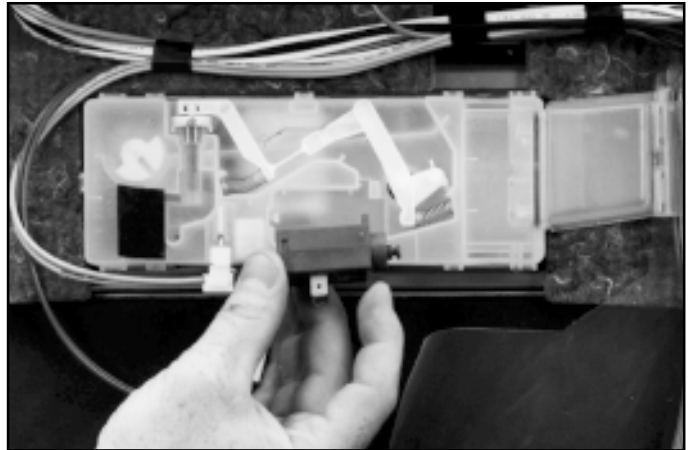

Fig. 8-2

...and bring the Actuator out from the Dispenser.

Please note: The Combination Lever cannot be replaced individually, but only as part of a new Dispenser Assembly.

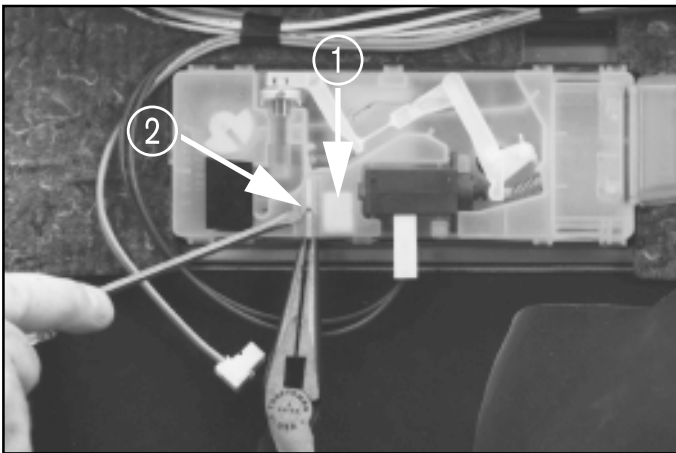

Fig. 8-3

When the Dispenser requires Rinse Agent a Magnetic Float, Fig. 8-3, item 1, will lower and draw the contacts of a Reed Switch, Fig. 8-3, item 2, together. This completes the circuit, and activates the Refill Rinse Agent LED located on the Facia Panel.

To remove the Reed Switch, first disconnect the Wiring Connector. Now, using a small screwdriver push in on the Reed Switch Mounting Tab, Fig. 8-3.

As you push in on the mounting tab, use a needle-nose pliers to bring the switch down and out from the Dispenser, Fig. 8-4.

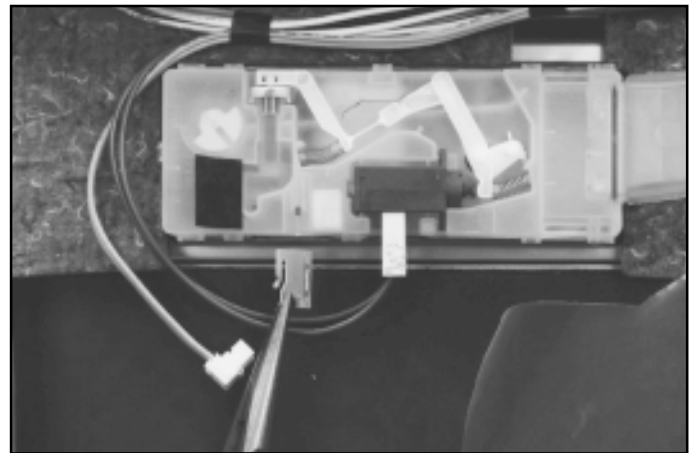

Fig. 8-4

Dispenser Removal

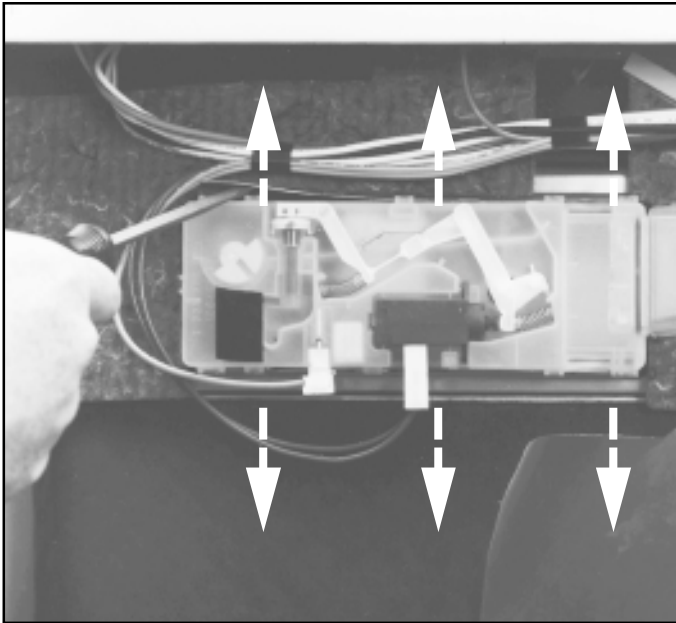

Fig. 8-5

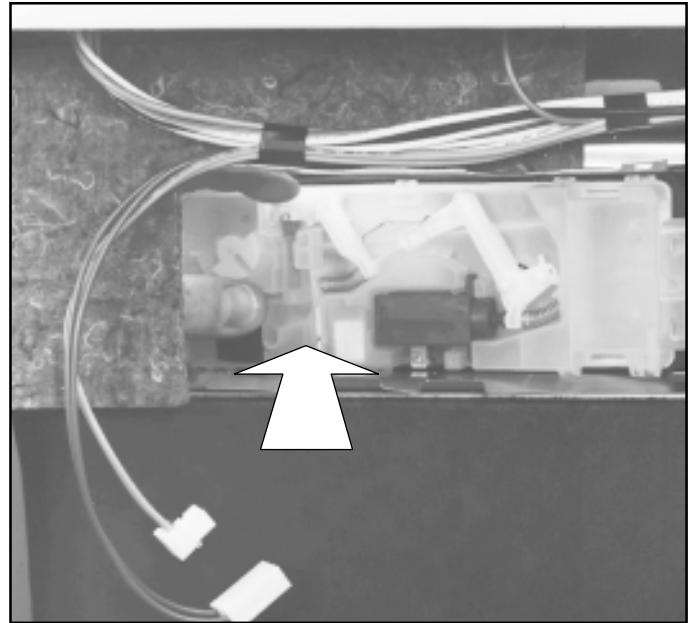

Fig. 8-6

If required, the Dispenser Assembly can be replaced as a complete unit.

TO REMOVE:

First remove the:

Upper Rack (Section 3, Fig. 4-3).

Wiring Connectors for the PTC Actuator, Reed Switch and Condensation Tube.

The Condensation Tube is inserted into the right side of the Dispenser with a gasket seal, and press fit along the right side of the Inner Stainless Steel Door.

To remove, first remove any securing tape or wire ties for both the Condensation Tube and Upper Wiring Harness. Then, disengage the tube from the door by pulling it toward you, and sliding the tube out from the Dispenser.

Now, using a broad tipped regular screwdriver spread the top and bottom metal positioning strips away from the Dispenser, Fig. 8-5.

Then apply light pressure to the Dispenser, and break the seal between it and the Inner Stainless Steel Door, Fig. 8-6.

TO INSTALL:

Clean the inner portion of the stainless steel door where the Dispenser Gasket will seat. Then bend the positioning strips back into place, straightening them if necessary.

Now, insert the new Dispenser making sure the positioning strips fit snugly against the Dispenser Body. The Dispenser Gasket will make a watertight seal so caulk or sealant is not required.

Replace the Condensation Tube, Wiring Connectors and Upper Rack.

Facia Assembly

IMPORTANT SERVICE NOTE:

The Facia Assembly cannot be removed unless the Outer Door is removed first.

See section 4, Fig. 7-1.

FACIA ASSEMBLY REMOVAL:

After removing the Outer Door, remove the six T-20 Torx screws securing the Facia Assembly to the Inner Stainless door, Fig. 9-1.

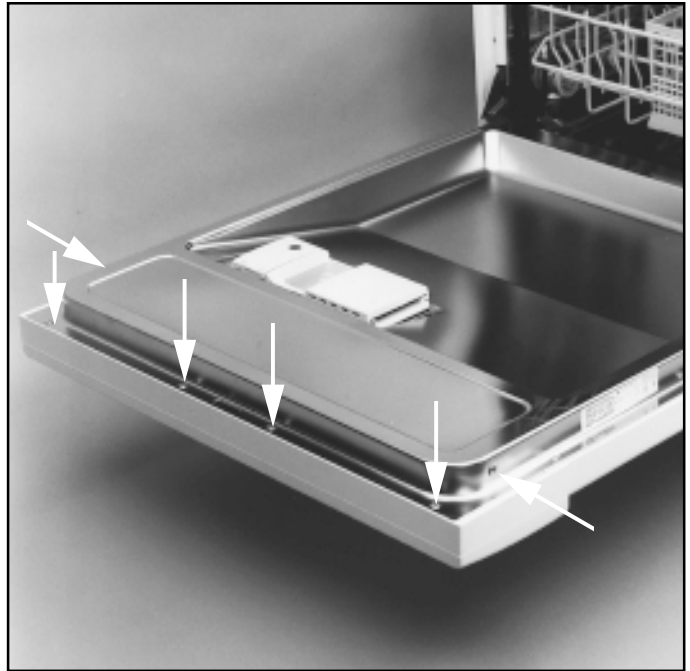

Fig. 9-1

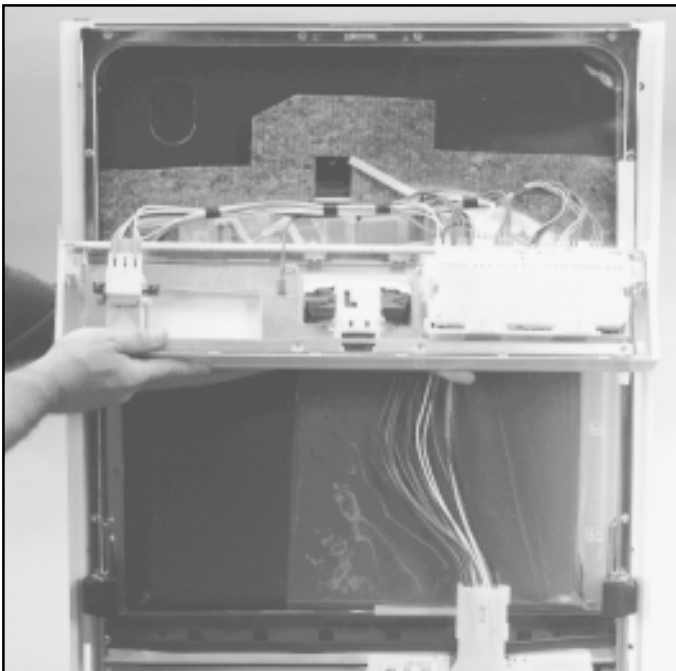

Fig. 9-2

With the screws removed, bring the Facia Assembly down cradling it so as not to scratch the Facia Console.

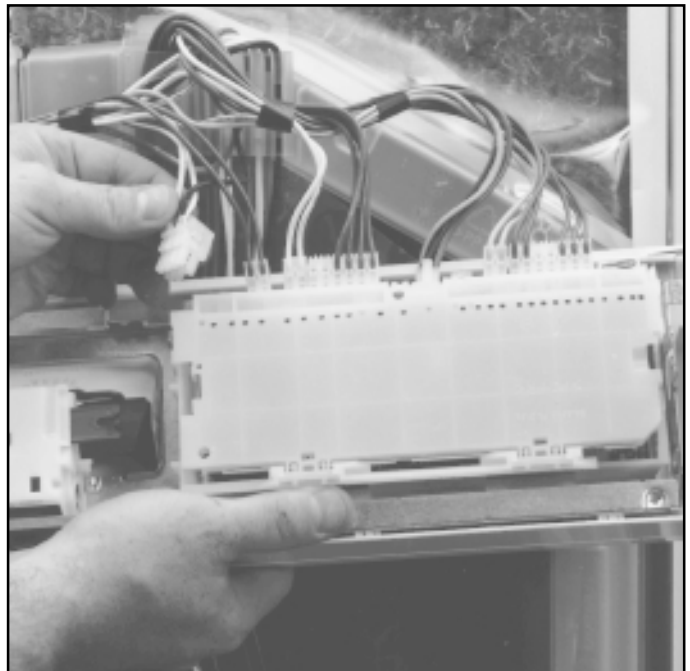

Fig. 9-3

Now remove the Wiring Connectors by pressing in on the locking tabs of each connector, then sliding the connector up and off from the Control Unit.

Facia Assembly

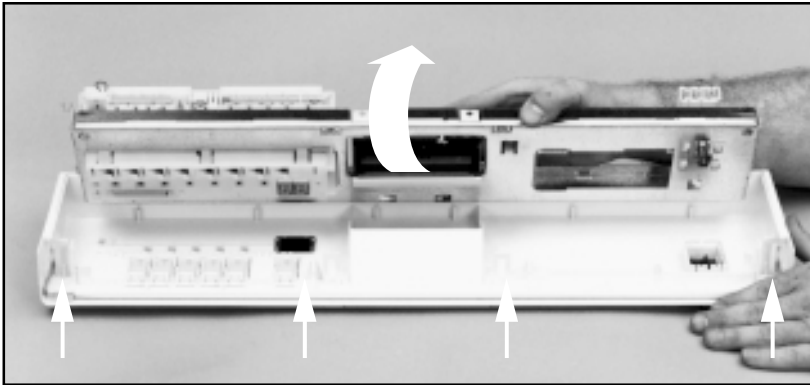

Fig. 9-4

With the Facia Assembly removed from the unit, it can be further separated into two assemblies.

To separate, release the four locking tabs and bring the Facia Frame up from the Facia Console, Fig. 9-4.

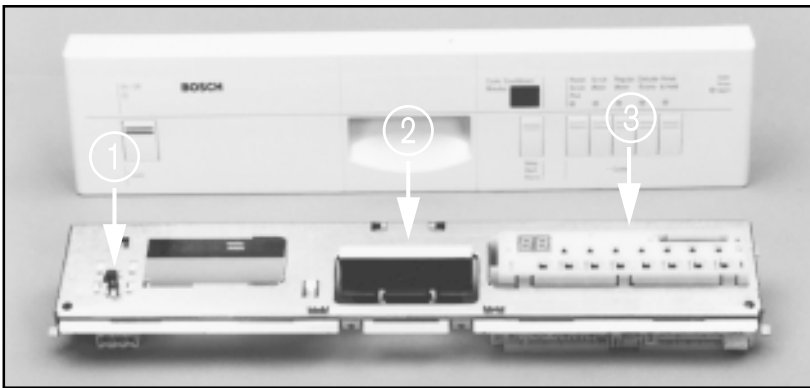

Fig. 9-5

The Facia Frame houses three components:

Item 1, On/Off Switch.

Item 2, Door Latch Assembly.

Item 3, Control Unit.

Note: The Facia Console or Program Buttons can be replaced at this time.

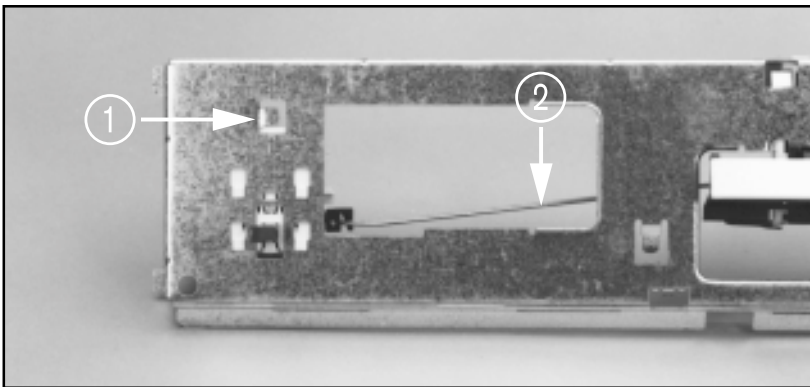

Fig. 9-6

ON/OFF SWITCH REMOVAL:

Bend the single tab up, item 1.

Then slide the switch up and out from the frame, and remove the Locking Lever, item 2.

Note: The Locking Lever, item 2, switches the unit off when the door is opened during operation.

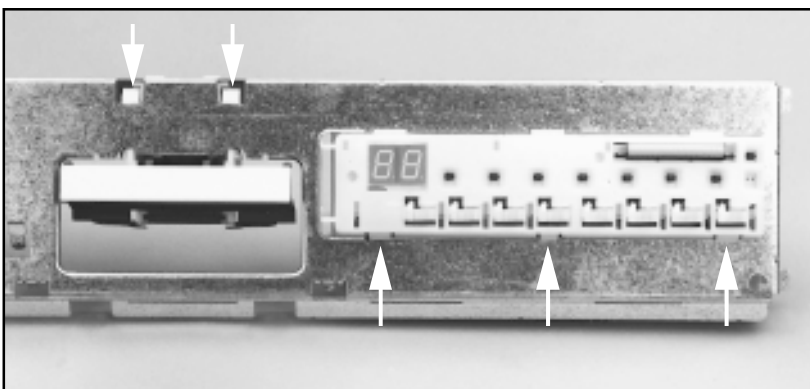

Fig. 9-7

DOOR LATCH ASSEMBLY REMOVAL:

Bend the two tabs up and slide the Latch down.

CONTROL UNIT REMOVAL:

Press in on the three locking tabs and bring the Control Unit out from the Console Frame.

Note: Always reset the new Control Unit by pressing the appropriate cancellation buttons, see Section 2.

Notes

Section 5

Description		Page
Base Components – Front Accessible:	Electrical Connection	38
	Circulation Motor Capacitor	38
	Leveling Legs	39
	Water Valve	39
	Drain Motor	40 – 41
Notes		42

Base Components – Front Accessible

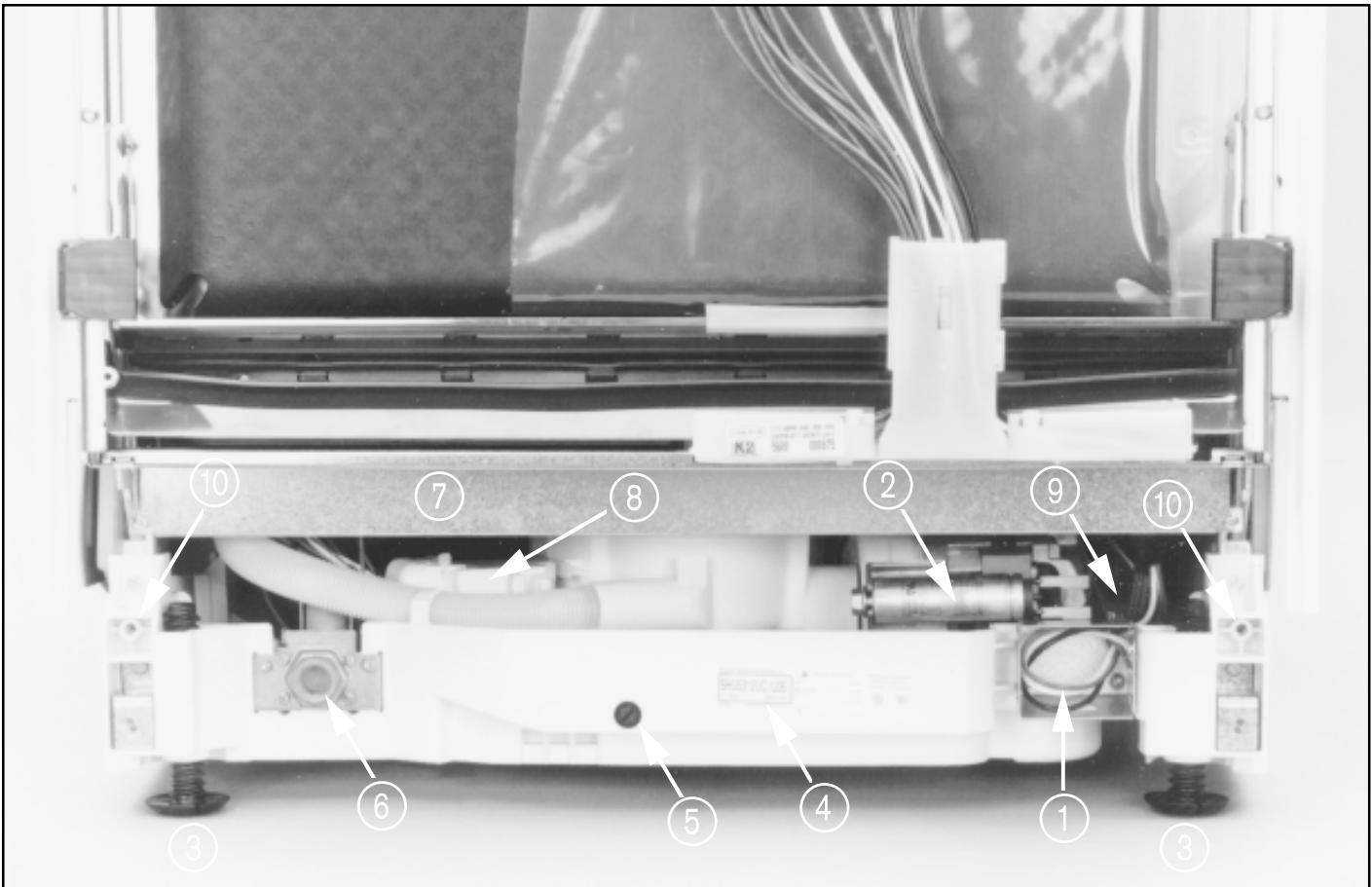

Fig. 10-1

Service note: To gain access to the Front Accessible Lower Components remove the Toe Kick. Also, for better visibility it is strongly recommended that the Outer Door be removed as well.

The Front Accessible Lower Components consist of the following items.

1. Electrical Connection.
2. Circulation Motor Capacitor.
3. Front Leveling Legs.
4. Model and Serial number tag.
5. Rear Leveling Leg adjustment screw.
6. Water Solenoid Valve.
7. Access Panel.
8. Drain Motor.
9. Circulation Motor.

The Circulation Motor cannot be replaced from the front, but is accessible for voltage or wiring testing.

10. Door Spring Adjustment Screws.

The adjustment can only be made when an accessory door panel is added to the unit. Turning the screw clockwise will balance the additional weight of the added panel.

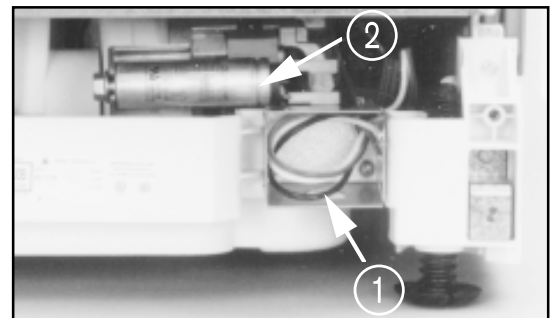

Fig. 10-2

The electrical connection, item 1, is a three wire hook-up that is secured with wire-nuts.

The color code is as follows:

Black = Hot
White = Neutral
Green = Ground

The Circulation Motor Capacitor, item 2, is a 10uf-Start/Run Capacitor held to the Circulation Motor with a single 13mm nut. The Capacitor can be replaced as a separate component without removing the Circulation Motor.

Base Components – Front Accessible

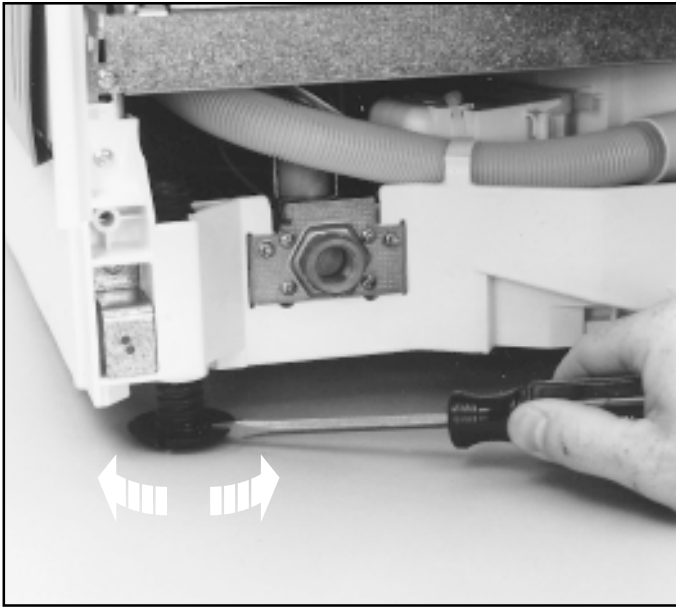

Fig. 10-3

The front Leveling Legs can be adjusted by inserting a regular tipped screwdriver into the foot slot and turning the leg in the desired direction.

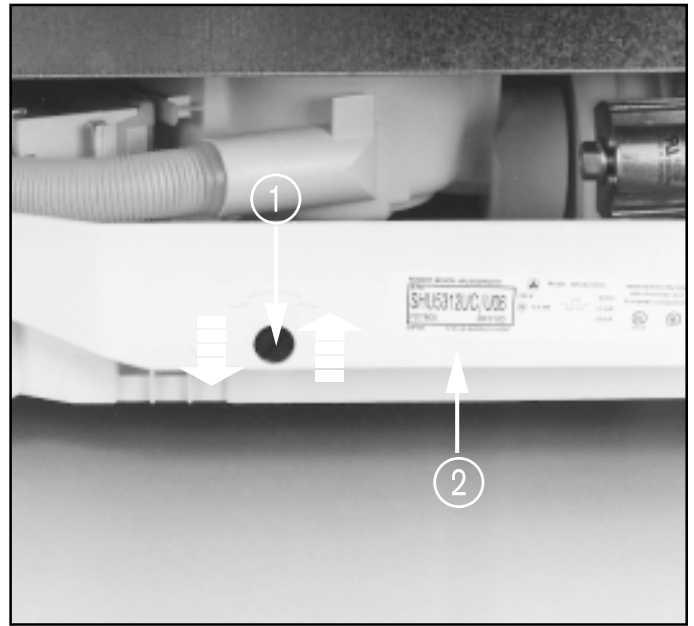

Fig. 10-4

The Rear Leg Adjustment Screw, item 1, allows the single Rear Leveling Leg to be adjusted from the front of the unit. Turning the screw clockwise will extend the leg, and counter-clockwise retracts it.

For convenience an additional Serial Number Tag, item 2, is located on the Base.

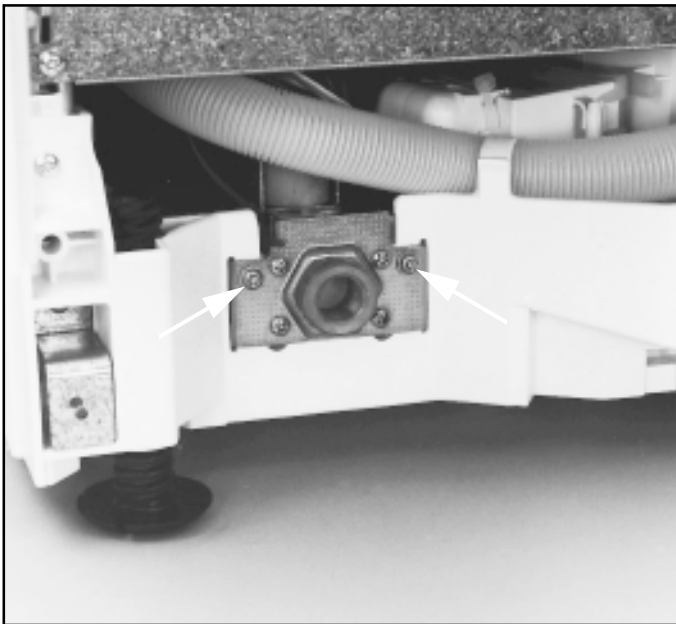

Fig. 10-5

To replace the Water Solenoid Valve, first remove the two T-20 Torx valve mounting screws.

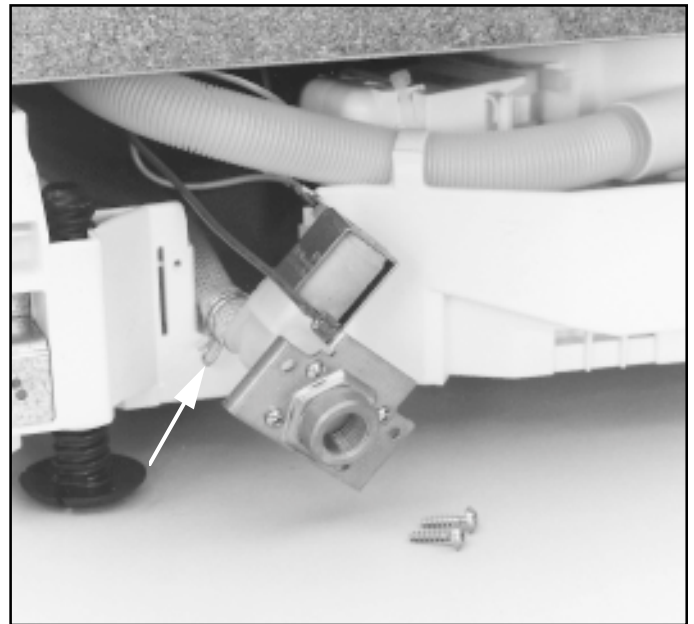

Fig. 10-6

Then bring the Water Valve out from the Base, and disconnect the water line by loosening the Water Line Clamp (arrow) and removing the wiring leads.

Base Components – Front Accessible

Service note: To provide the required access that will allow the Drain Motor to be replaced, the Lower Access Panel must be removed, and as previously mentioned the Outer Door Panel should also be removed.

To remove the Lower Access Panel, Fig. 10-7, item 1, remove the two T-20 Torx screws located in the left and right corners of the panel.

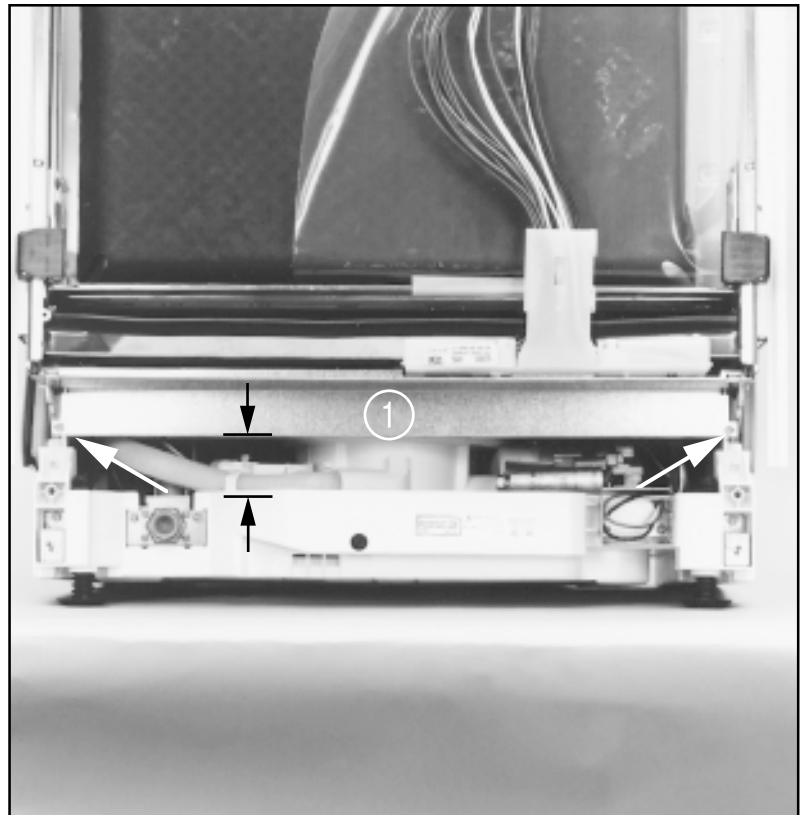

Fig. 10-7

As demonstrated in Figs. 10-7 and 10-8, with the Lower Access Panel removed you gain all the space required to replace the Drain Motor, Fig. 10-8, item 1, as well as allowing better visibility to the Circulation Motor Wiring, Fig. 10-8, item 2, rear components, wiring and hoses.

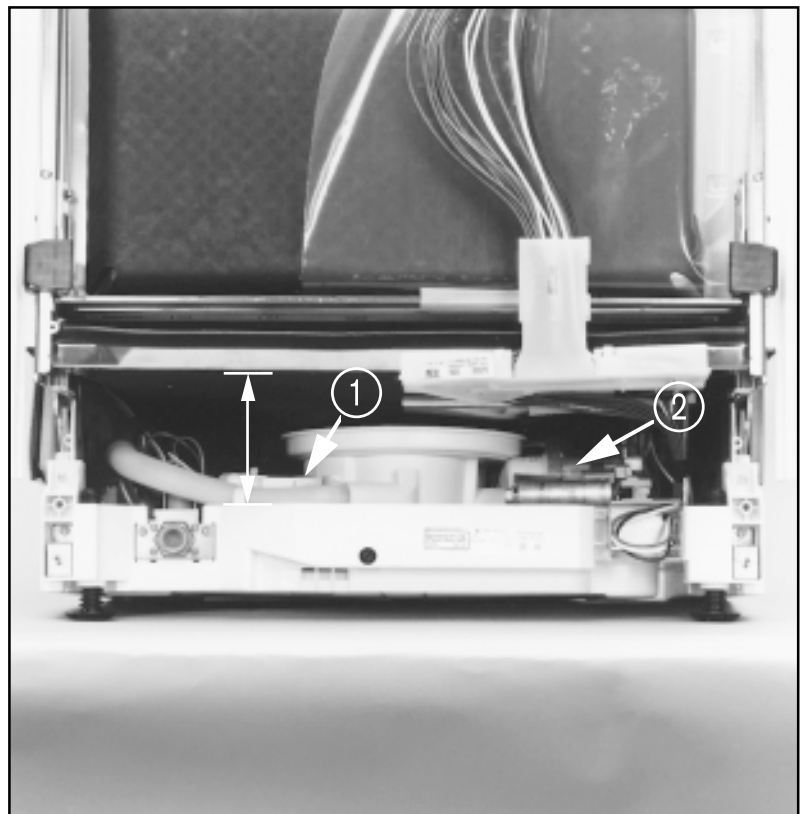

Fig. 10-8

Base Components – Front Accessible

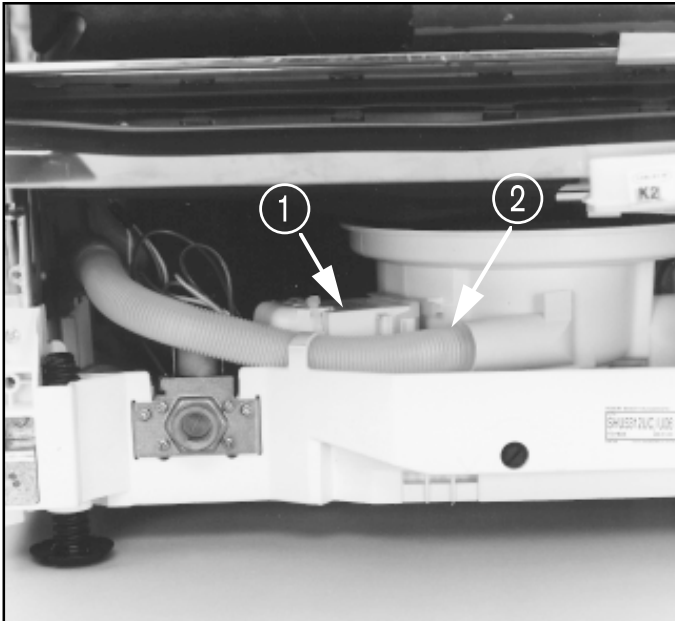

Fig. 10-9

To remove the Drain Motor, item 1, first remove the Sump Fill Hose, item 2, by pulling it out from the Sump and side inlet connections (see Fig. 10-10)



Fig. 10-10

This cut away view shows:

- Item 1, Drain Motor.
- Item 2, Drain Motor Locking Tab.
- Item 3, the Sump Fill Hose and its two connection points A and B.

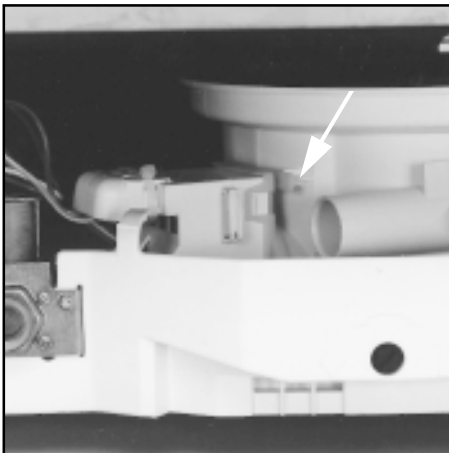

Fig. 10-11

Next, remove the wiring connectors and then while pulling back on the Locking Tab, turn the Drain Motor clockwise.

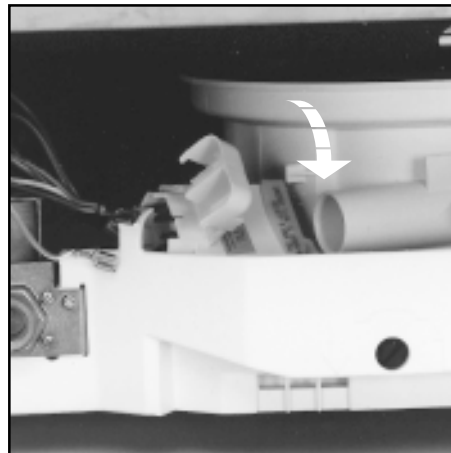

Fig. 10-12

Continue turning the Drain Motor clockwise until it reaches the two O'clock stop position. Then bring the motor out from the Sump.

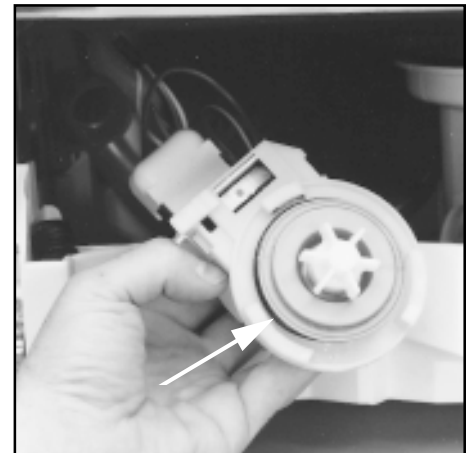

Fig. 10-13

The Drain Motor is mounted to the Sump using a slot and tab fit. To install the Drain Motor, insert it back into the Sump at the two O'clock position making sure that all three slots and tabs line up, then turn counter-clockwise until secure and the Locking Tab locks.

Service Reminder

From this point forward, all service procedures demonstrated in the remainder of this repair manual, will require the dishwasher to be disconnected and removed from the cabinet for servicing.

Section 6

Description	Page
Left Side Access	44
Left Side Components	45
Water Inlet / Discharge System – Operation	46 – 47
Water Inlet / Discharge System – Removal	48

Left Side Access

LEFT SIDE PANEL REMOVAL:

Remove the two T-20 Torx screws located on the top and bottom of the Left Trim Strip, Fig. 11-1, and then slide the Trim Strip up and off the unit.

Figs. 11-2 and 11-3

The Side Panel is press fit onto the Front and Rear Corner Blocks of the dishwasher. To remove the panel, gently lift up on the front corner disengaging it from the Front Corner Block, arrow A. Then bring the panels back corner off the rear block while moving the panel toward the rear of the dishwasher, arrow B.

Bring the panel out from the side of the unit about forty-five degrees, and then lift it out from the Base Lip.



Fig. 11-1



Fig. 11-2

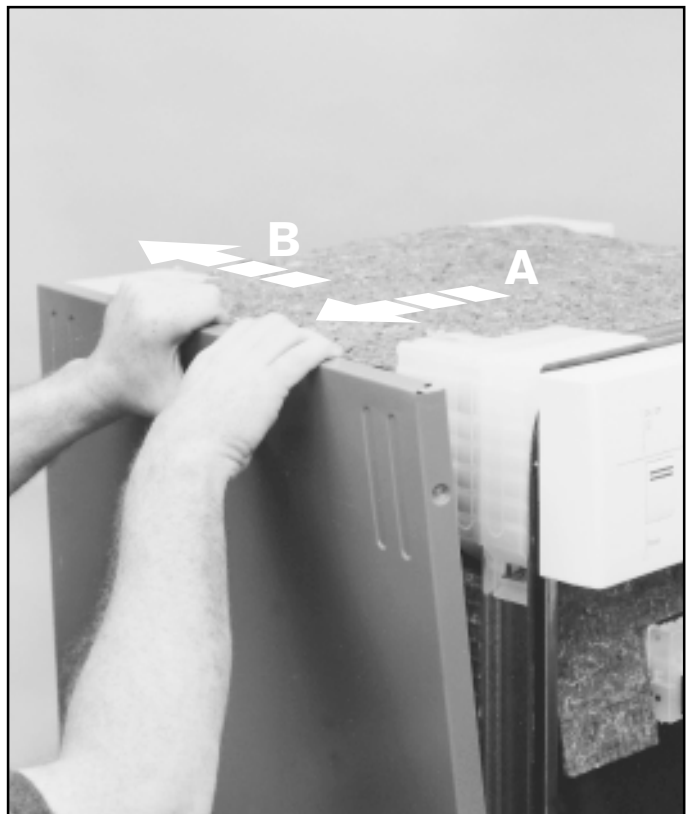
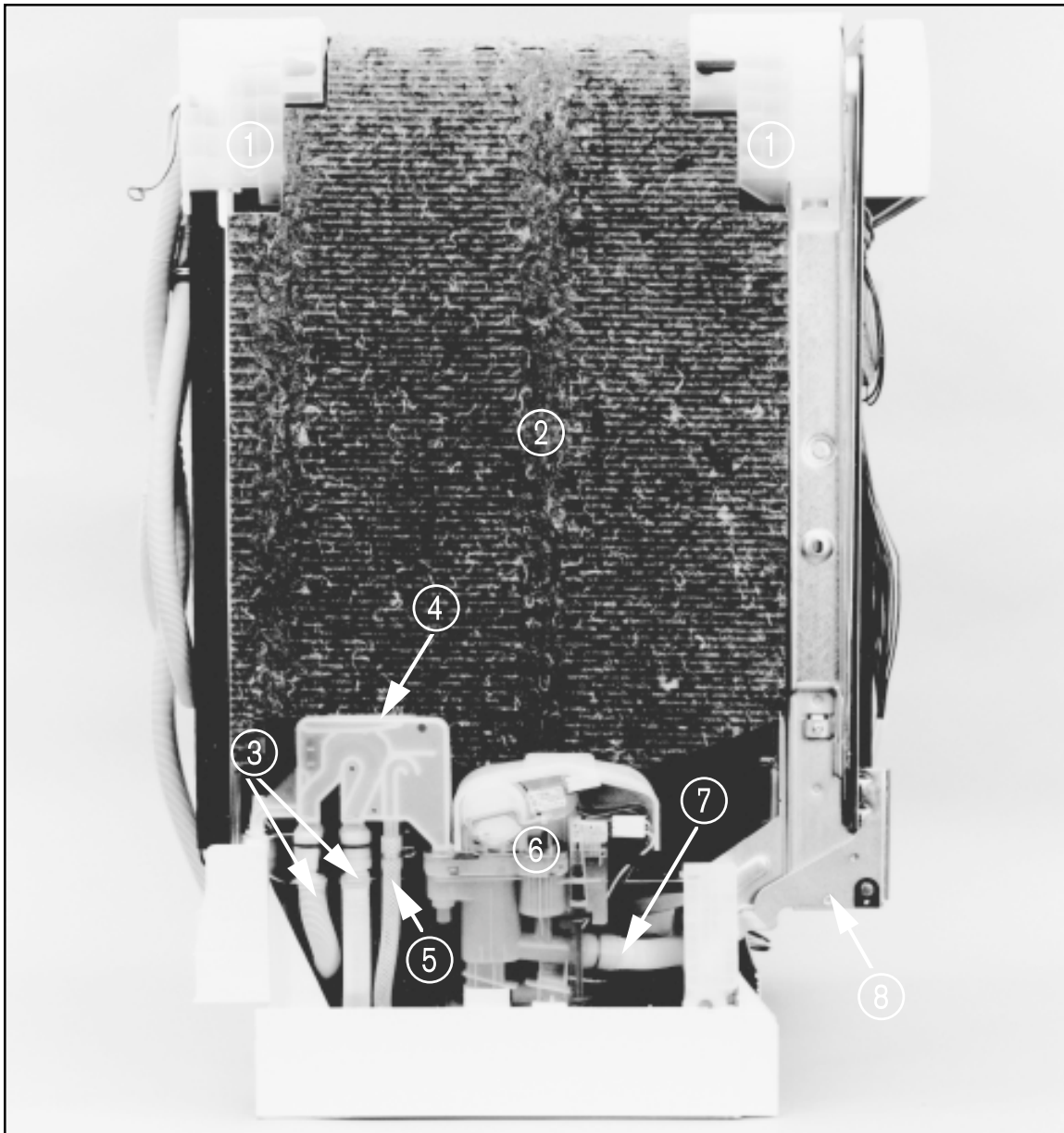

Fig. 11-3

Left Side Components

**Fig. 11-4**

With the Left Side Panel removed you now have access to the following components:

1. Corner Blocks.
2. Cloth Fiber Insulation Panel.
3. Drain Hoses.
4. Water Chamber.
5. Inlet Water Line.
6. Water Level Housing Assembly.
7. Sump Fill Hose.
8. Left Hinge.

Water Inlet / Discharge System – Operation

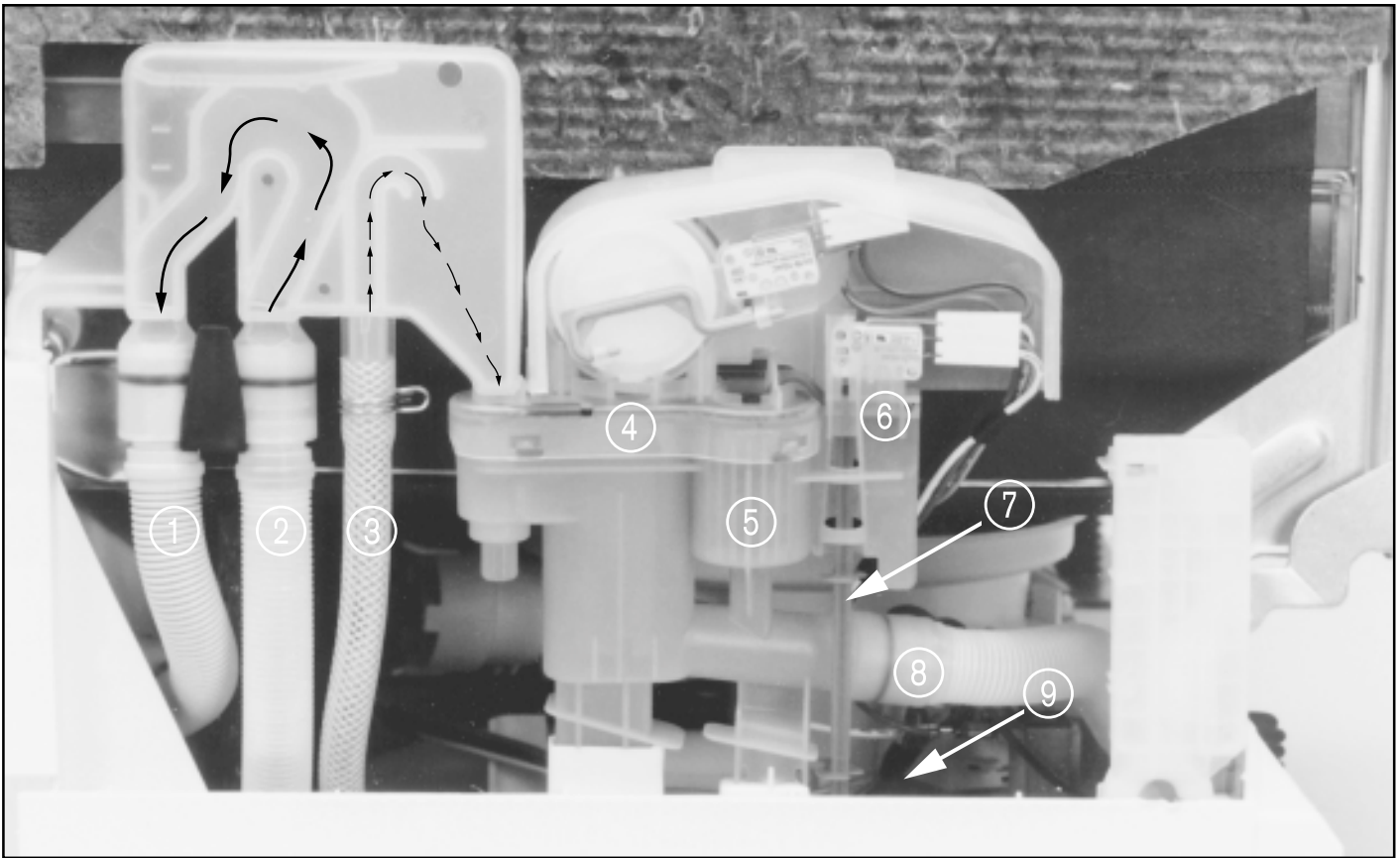

Fig. 12-1

Normal Fill

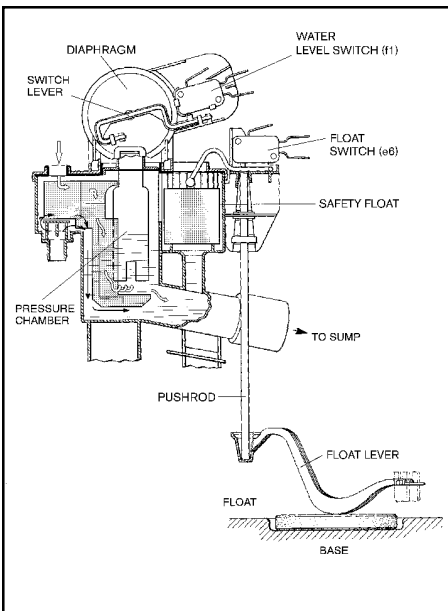

Fig. 12-2

Over Fill

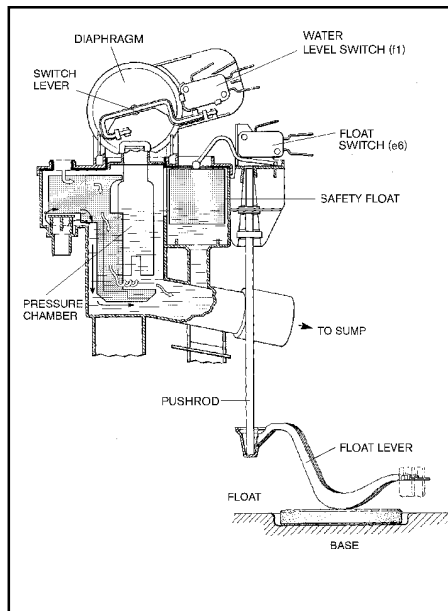

Fig. 12-3

Base Float

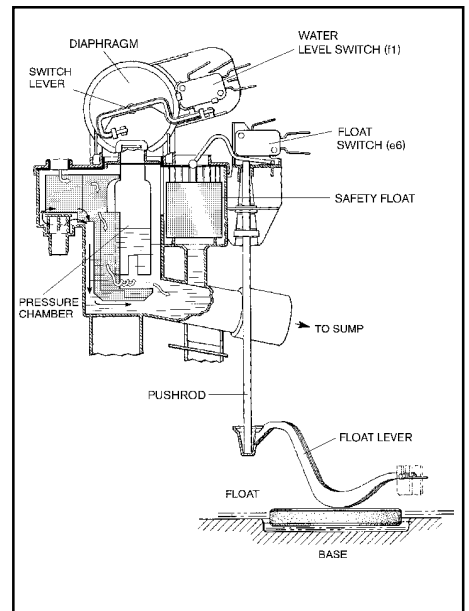

Fig. 12-4

Water Inlet / Discharge System – Operation

WATER SYSTEM OPERATION: Fig. 12-1 is a close up view of the complete Water Systems.

FILLING

NORMAL OPERATION (Fig. 12-2)

Fresh water is brought in by the Water Valve and through the Inlet Water Line, item 3. The incoming water is then directed into the Water Level Housing Assembly, item 4, and then on to the Sump via the Sump Fill Hose, item 8.

As the unit fills with water the Diaphragm on the Water Level Housing Assembly expands due to the pressure of air forced up by the incoming water. When the correct water level is reached the Diaphragm moves the Switch Lever, which in turn closes the Water Level Switch.

When the Water Level Switch closes the Water Valve shuts and the Circulation Motor is activated, and the program advances.

Note: Once the Circulation Motor is activated the water level will drop slightly, the unit then calls for a small amount of additional water to be added.

OVER FILL (Fig. 12-3)

As a safety feature, if the Diaphragm were to malfunction the water level would rise and activate the Safety Float, item 5. As the Safety Float rises it in turn closes the Float Switch, item 6. When the Float Switch closes it activates the Drain Motor.

Service tip: If the dishwasher repeatedly fills and drains the cause is most likely a faulty Diaphragm.

BASE FLOAT (Fig. 12-4)

As an additional safety feature, if the Base were to fill with water due to a hose or pump leak the Base Float, item 9, will rise and via a Float Lever and Pushrod, item 8, would close the Float Switch, which in turn activates the Drain Motor.

Service tip: If there is water in the base the Drain Motor will run continually, but will not drain water from the base.

“F” CODE

Dishwashers with a Countdown Display will show an “F” in the display window when a filling fault occurs. Filling faults can be: Water in the base; overfill; and under or no fill.

Live Dealer Display Models with “F” codes:

Since display models are hand filled, achieving the correct water level is difficult, (see Section 3, Fig. 5-7) so the unit will perceive a filling fault and display the “F” code. This is normal, do not attempt a repair.

DRAINING

When the Drain Motor is activated gray water flows from the Sump through the Sump Drain Hose, item 2, around the Water Chamber and out through the Main Drain Line, item 1.

Water Inlet / Discharge System – Removal



Fig. 12-7

The Water Level Switch and Diaphragm are replaced as one assembly. To replace, bend the small retaining tab out away from the assembly.

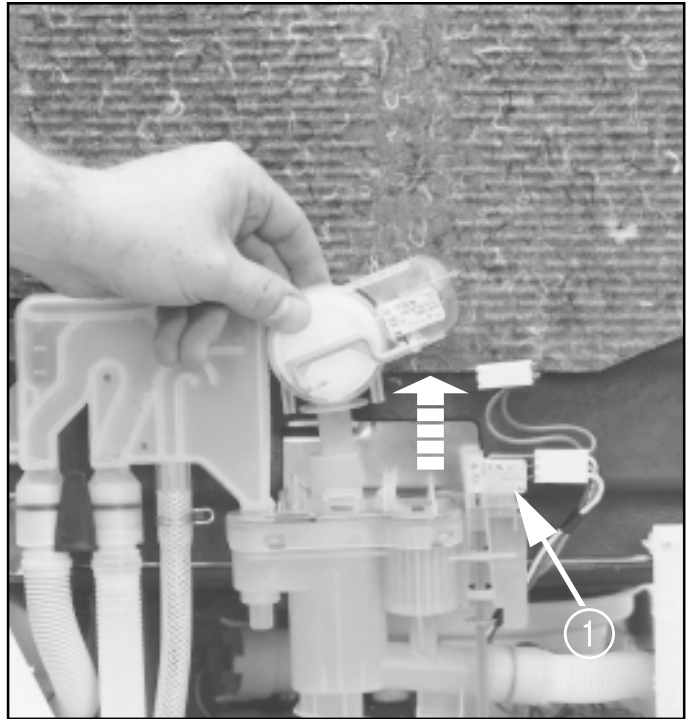

Fig. 12-8

Then remove the wiring connector and slide the assembly up and out from the Water Level Housing.

The Float Switch, item 1, is a press fit and easily removed as an individual component.



Fig. 12-9

To replace either Drain Hose, first remove the Drain Hose retaining clip.



Fig. 12-10

Then bring the hose down and out from the Water Chamber. When re-installing make sure the hose is snug, and the retaining clip is back in place.

Section 7

Description	Page
Right Side Access	50
Right Side Components	51
NTC Operation	52
NTC Removal	53 – 57
Notes	58

Right Side Access



Fig. 13-1

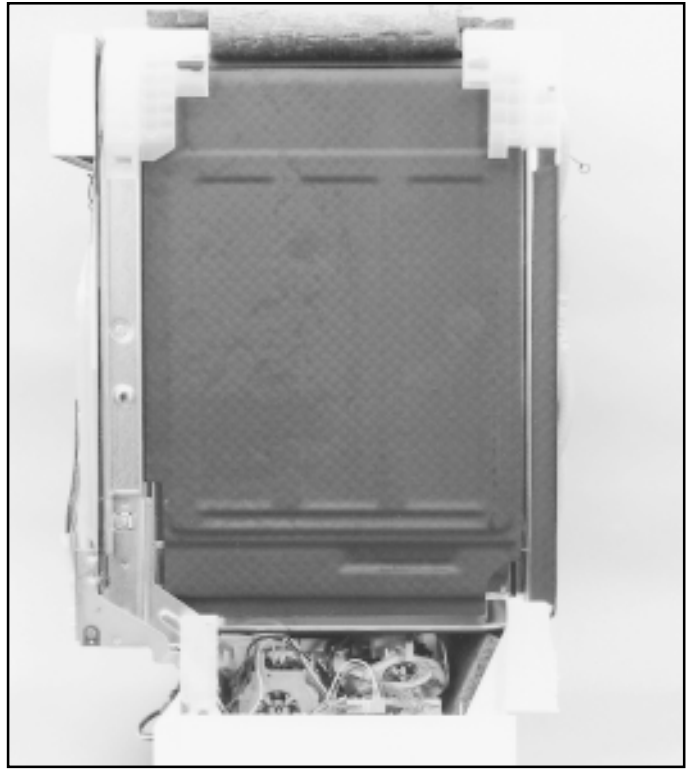

Fig. 13-2

RIGHT SIDE PANEL REMOVAL:

Remove the two T-20 Torx screws located on the top and bottom of the Left Trim Strip, Fig. 13-1, and then slide the Trim Strip up and off the unit.

To remove the panel, refer to Section 6, Figs. 11-2 and 11-3.

Right Side Components

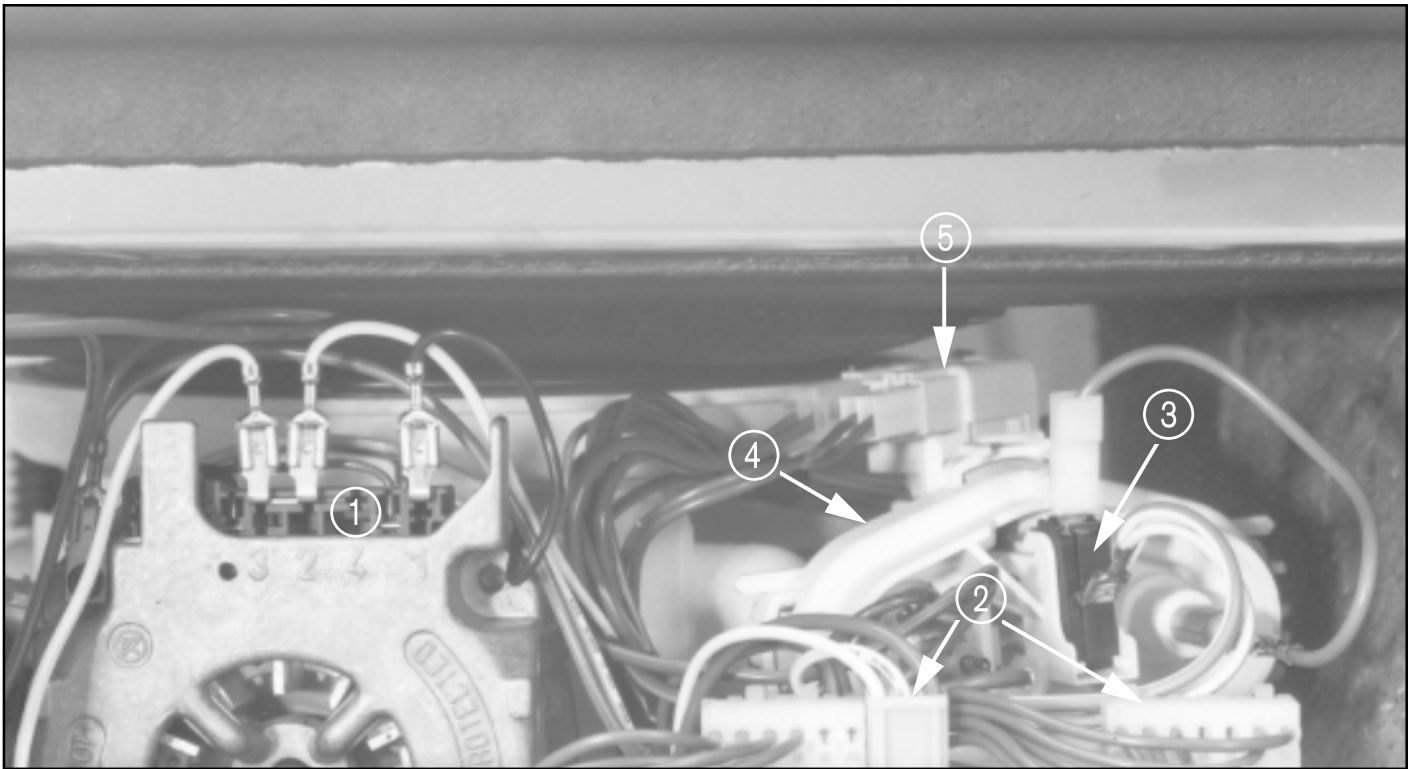
**Fig. 13-3**

With the Right Side Panel removed, you now have access to the following components.

1. Circulation Pump / Motor.
2. Base Wiring Connectors.
3. Flow Switch.
4. Heater Assembly.
5. NTC.

COMPONENT EXPLANATION:**Circulation Pump / Motor.**

The Circulation Pump / Motor can be replaced from the right side by following the same access procedures for removal of the NTC outlined in the remainder of this section, and then by following the steps in Section 8, Figs. 16-2 through 16-7, for the Circulation Pump / Motor removal.

Service Note: Section 8, also gives an alternative removal method for the Circulation Pump / Motor.

Base Wiring Connectors.

The Base Wiring Connectors allow the Upper Wiring Harness to mate with the Base Wiring Harness.

Flow Switch.

Located between the two heater terminals is the Flow Switch. In the event that water does not flow across the Heating Element, the Flow Switch disables the element. To remove the Flow Switch, bring the bottom of the switch out from its base, unhook the side tabs, and then lift the switch out.

Heater Assembly.

The Heater Assembly cannot be replaced from the side, but is accessible for continuity testing. Replacement of the Heater Assembly is outlined in Section 8, Figs. 16-8 through 16-12.

NTC Operation

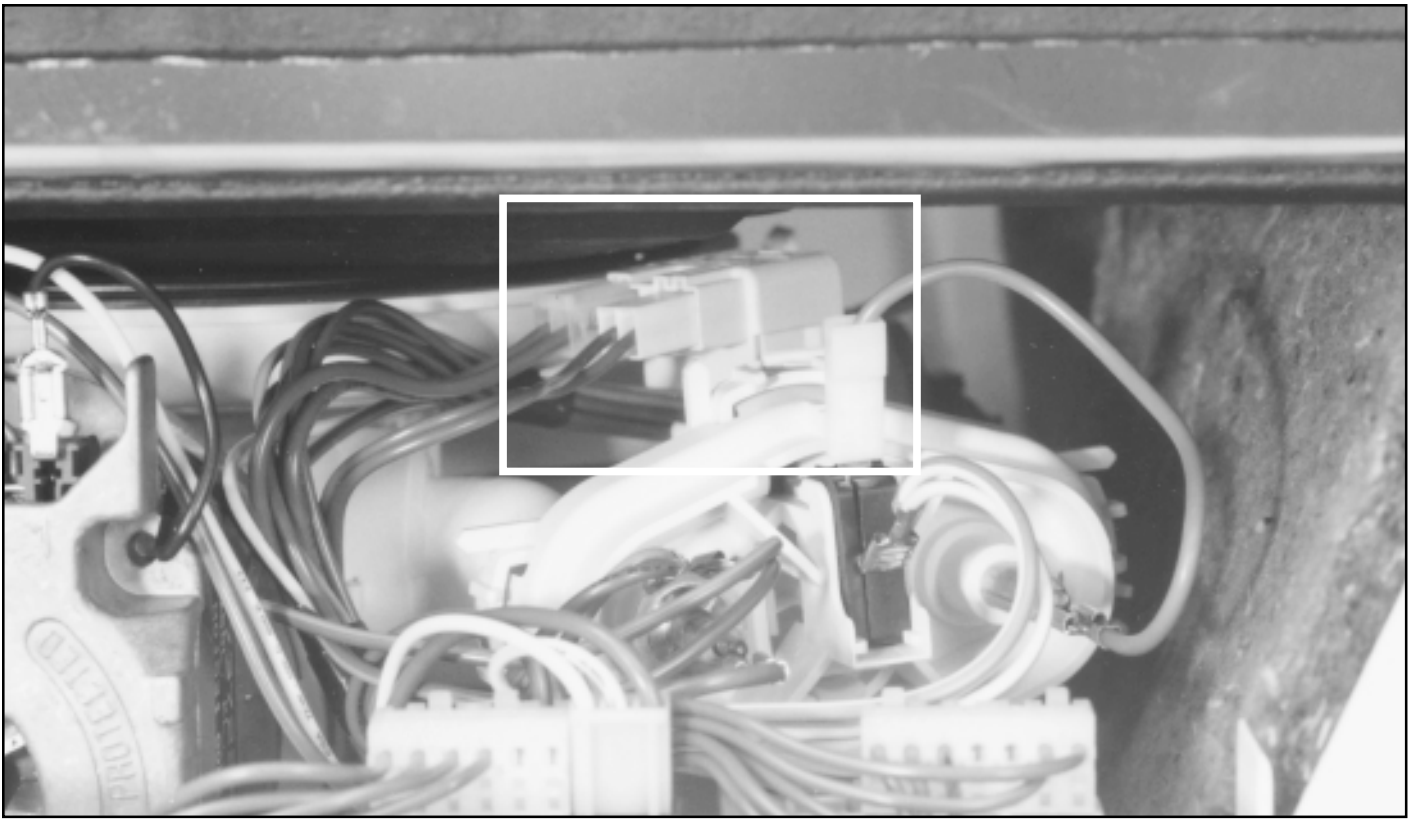

Fig. 14-1

Located on top of the Heater Assembly is the NTC (Negative Temperature Coefficient), Fig. 14-1. The NTC uses resistance to control wash and rinse water temperature and is connected with two green leads.

As water temperature increases, the NTC records the decrease in resistance. The Control Unit Logic Board measures this resistance change and allows the program to advance once the correct temperature (resistance level) is reached.

Service note: The SHU 30** and SHU 40** models do not use an NTC, but utilize a standard, normally open thermostat (bi-metal).

Also combined within the NTC (or standard thermostat) is a High Limit Safety Thermostat, connected with red leads. The normally closed high limit is set to 185° Fahrenheit and is self-resetting.

Service tip: The NTC can be checked without removing the dishwasher by measuring its resistance at the Control Unit. Using the appropriate wiring diagram, locate the two NTC leads. The resistance at room temperature should be approximately 55k Ohms.

An extremely high, low or no Ohm reading will usually indicate a faulty NTC.

NTC Removal

To replace the NTC, first remove the Right Side Panel, Outer Door and Toe Kick, Fig. 14-2.

Then, remove the two Front Base Mounting Screws, Fig. 14-3.

And the single Rear Base Mounting Screw, Fig. 14-4.

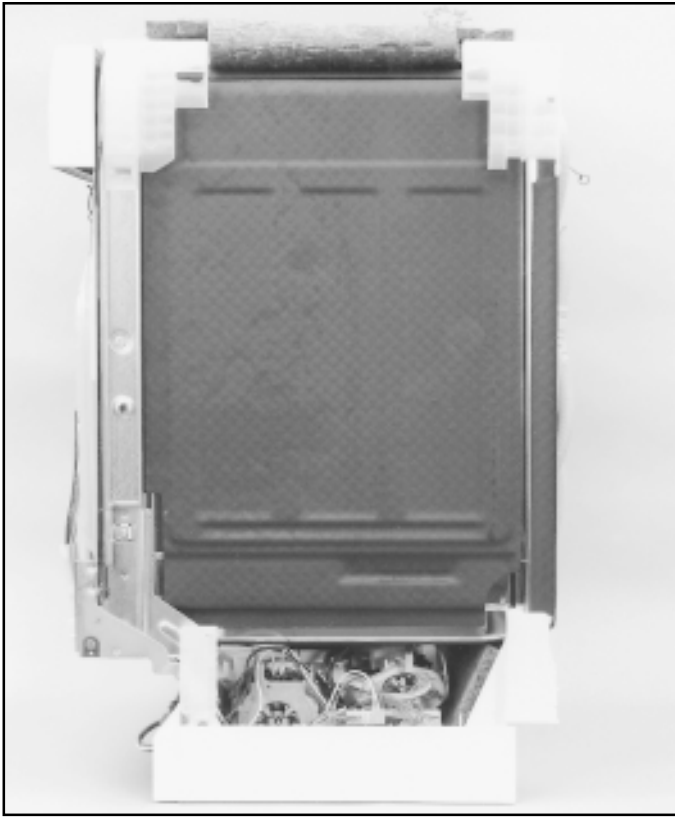

Fig. 14-2



Fig. 14-3

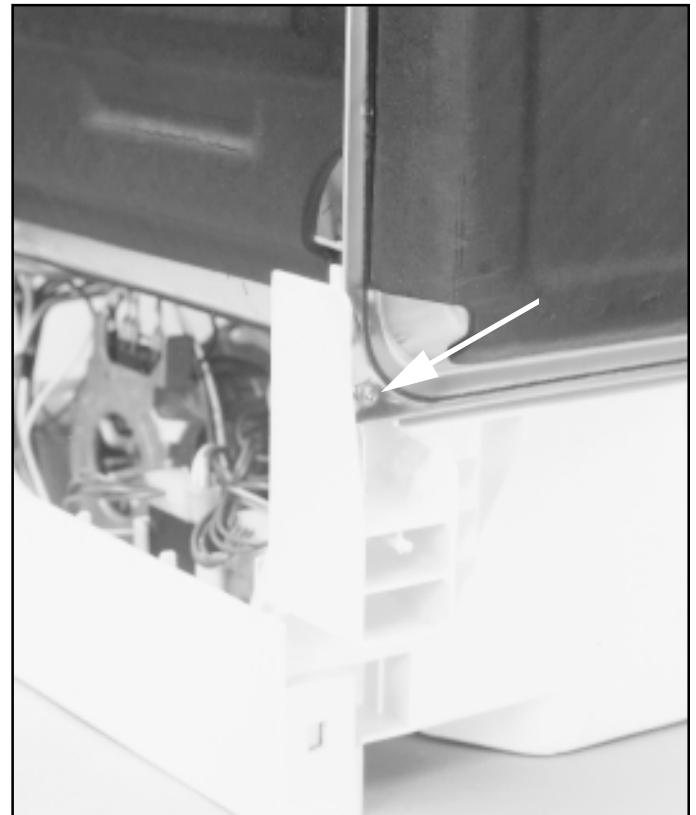

Fig. 14-4

NTC Removal

Next, remove the Hinge Cover...

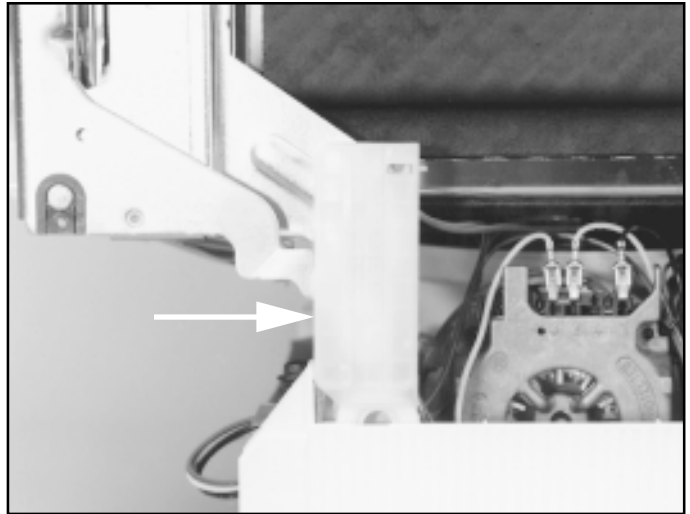

Fig. 14-5

and, unhook the Pulley Arm from the Hinge by lifting it up...



Fig. 14-6

and then off the Hinge.



Fig. 14-7

NTC Removal



Fig. 14-8

Now, from inside the dishwasher remove the Lower Spray Arm, Filter Basket and Screen, then remove the two screws that attach the Feeder Tube to the Sump, item 1. And the two Sump Clamps, item 2.



Fig. 14-9

With all steps complete, bring the Tank up from the Base and insert a block in the rear of the unit between the Tank and the Base.



Fig. 14-10

With the block in place you now have the required access to replace the NTC.

Service note: The Circulation Pump / Motor can also be replaced at this time, see Section 8.

NTC Removal

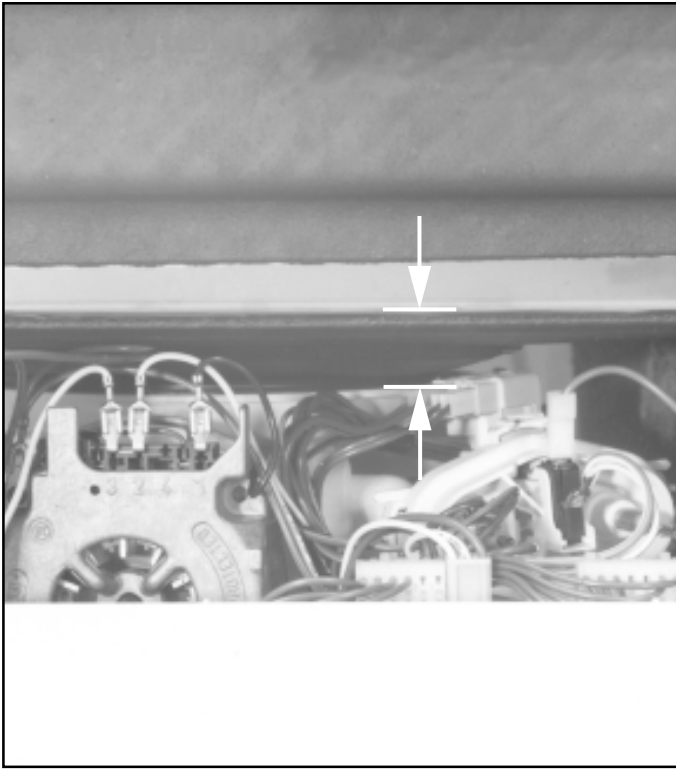

Fig. 14-11



Fig. 14-12

As demonstrated in Figs. 14-11 and 14-12, raising the Tank provides the necessary access space required to remove either the NTC or the Circulation Pump / Motor.

Service note: When re-seating the Tank make sure to check that it is inserted squarely back into the pump and seated properly.

NTC Removal

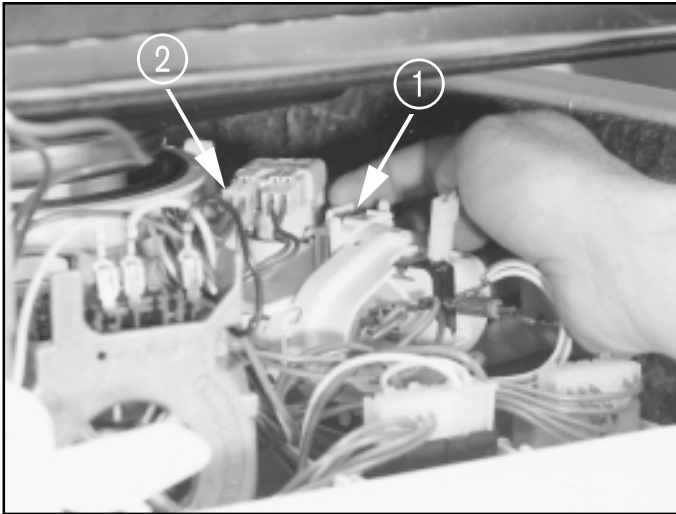

Fig. 14-13

The NTC is held in place by two locking tabs, items 1 and 2.

To remove the NTC from the Heater Assembly, unhook the front tab, item 1, and lift the NTC up slightly on that side, holding the tab open as you lift.

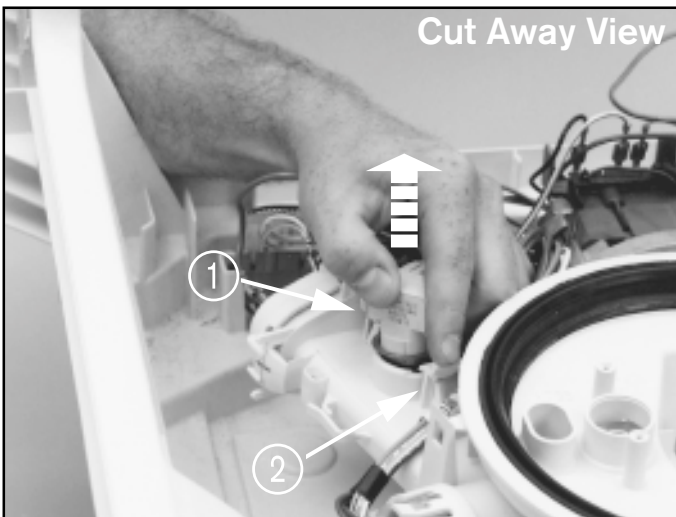

Fig. 14-14

Then unhook the rear tab, item 2, holding it open, while you slide the NTC up and out from the Heater Assembly.



Fig. 14-15

Once the NTC has been removed make sure to retrieve the NTC O-ring from the Heater Assembly if it is not on the NTC when it's removed.

Service tip: When installing the NTC, apply water to the O-ring so it will seat easier.

To avoid leaks, always make sure the NTC is secure and inserted completely into the Heater Assembly.

Notes

Section 8

Description	Page
Tank Removal	60 – 62
Base Components	63
Circulation Pump / Motor Removal	64
Circulation Pump / Motor Assembly	65
Heater Assembly Removal	66
Heater Assembly	67
Aqua Sensor	68
Door Spring Removal	69
Notes	70

Tank Removal

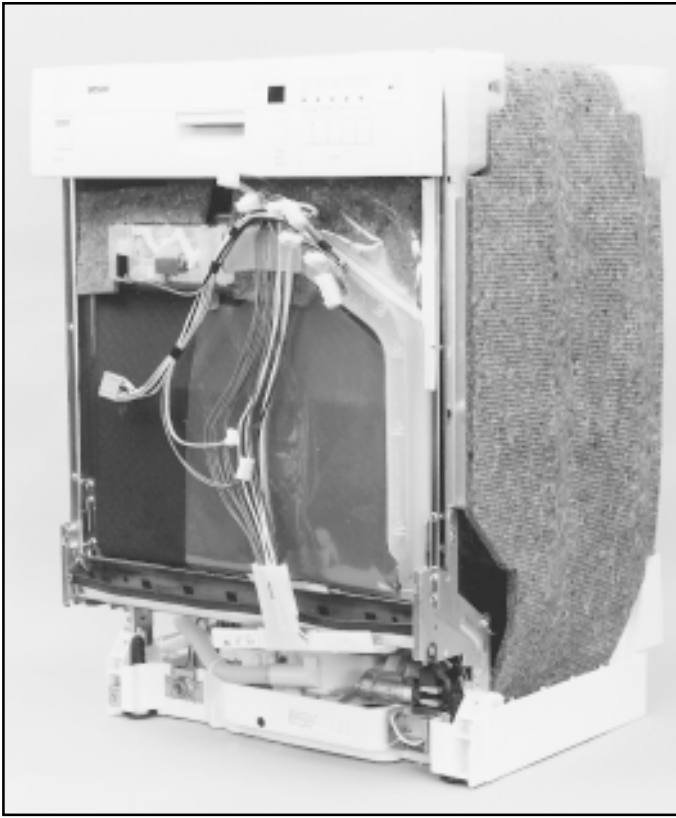

Fig. 15-1

In order to gain full access to the Circulation Pump / Motor, Heater Assembly and Aqua Sensor the Tank must be removed.

To remove the Tank, start by removing the Outer Door, Left and Right Side Panels, and Toe Kick, leaving the unit as shown in Fig. 15-1.

Next, disconnect the Upper Wiring Harness from the Control Unit and On/Off Switch, and then bring the harness off its mounting point on the Condensation Tube, Fig. 15-2.

Now from inside the dishwasher remove the Lower Spray Arm, Filter Basket and Screen, then remove the two screws that attach the Feeder Tube to the Sump, item 1. And the two Sump Clamps, item 2.



Fig. 15-2

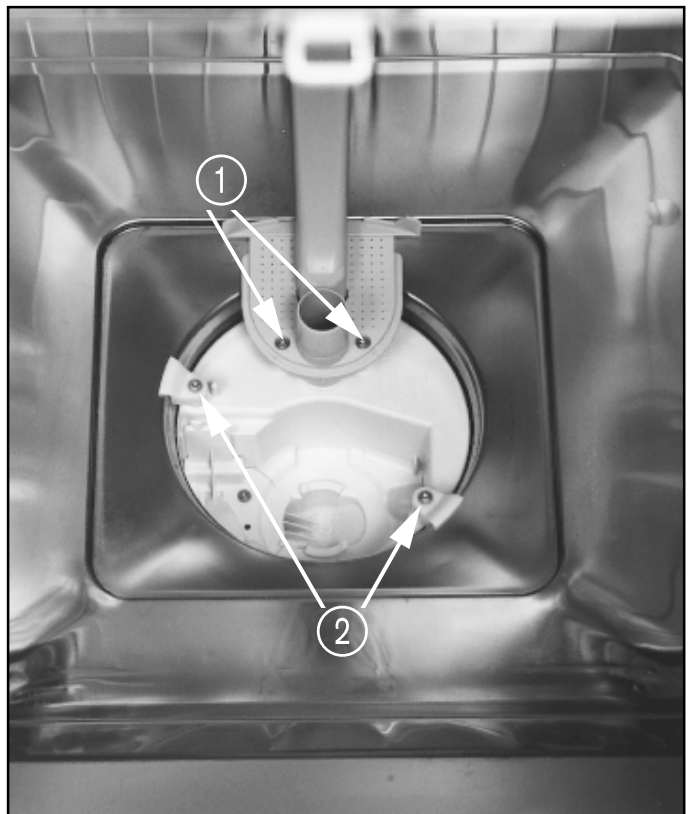

Fig. 15-3

Tank Removal

Then on both the left and right sides, remove the Hinge Covers...

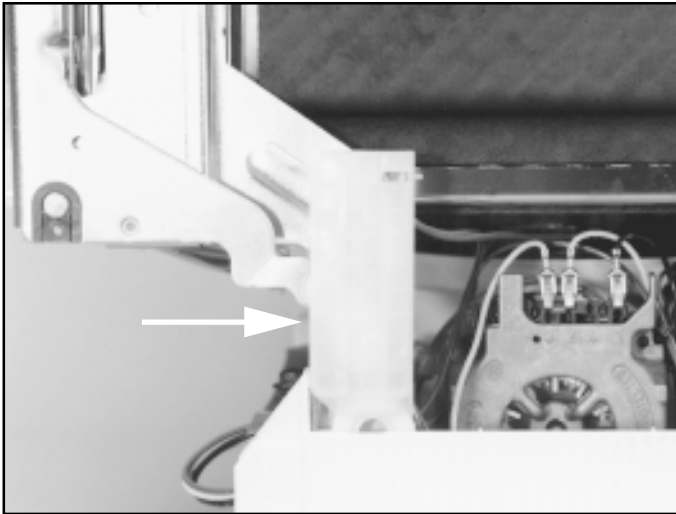

Fig. 15-4

and unhook the Pulley Arms from both Hinges by lifting them up...



Fig. 15-5

and then off the Hinges.



Fig. 15-6

Tank Removal



Fig. 15-7

Fig. 15-7

Now on both the left and right sides remove the T-20 Torx Tank Mounting Screws, item 1, and the Door Hinge Pivot tab, item 2.

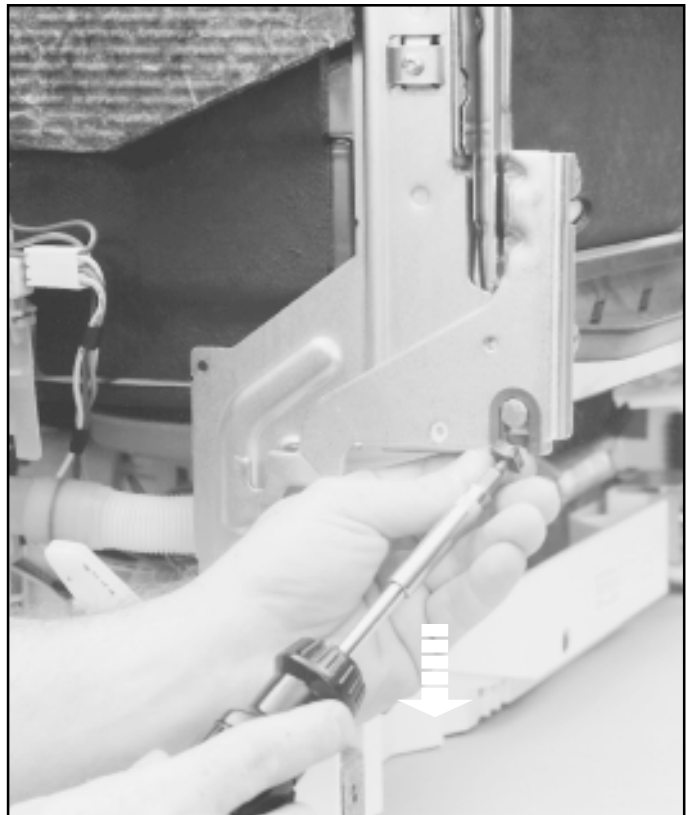

Fig. 15-8

Fig. 15-8

To remove the Door Hinge Pivot Tab, insert your T-20 Torx bit into the Tab and bring the screwdriver down releasing the tab.

Service note: The tab is a press fit, and will simply snap into position when replaced.

Fig. 15-9

With both Tank Mounting Screws and Door Hinge Pivot Tabs removed bring the Inner Door up and off the unit. The Lower Door Seal, item 1, will pull away as you remove the door.

Set the door aside.

Service note: The Door Seal is a press fit along the bottom lip of the tank. To avoid leaking, make sure the Door Seal is correctly inserted back along the tank lip when replaced.



Fig. 15-9

Base Components

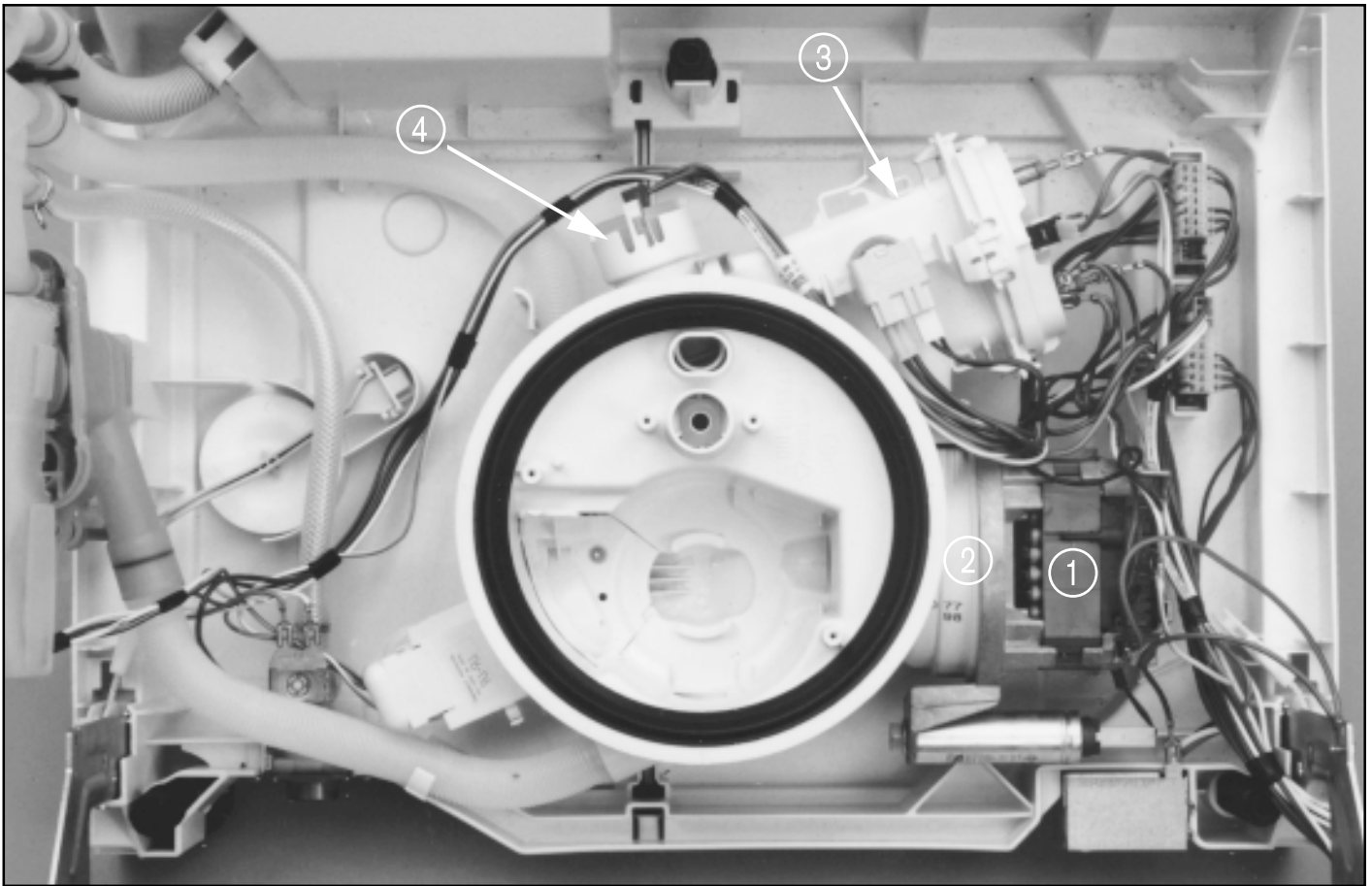

Fig. 16-1

The Tank can now be removed from the Base.

Service note: Once removed, lay the Tank on its back so as not to damage the tank bottom. When re-seating the Tank make sure to check that it's inserted squarely back into the Sump and seated properly.

With the Tank removed you now have access to the following components:

1. Circulation Motor
2. Circulation Pump
3. Heater Assembly
4. Aqua Sensor

Service reminder: As previously mentioned in Section 7, the Circulation Pump / Motor can also be replaced from the right side without removing the Tank. However, the additional visibility and access the Tank removal method allows can be a greater benefit for this repair.

Circulation Pump / Motor Removal

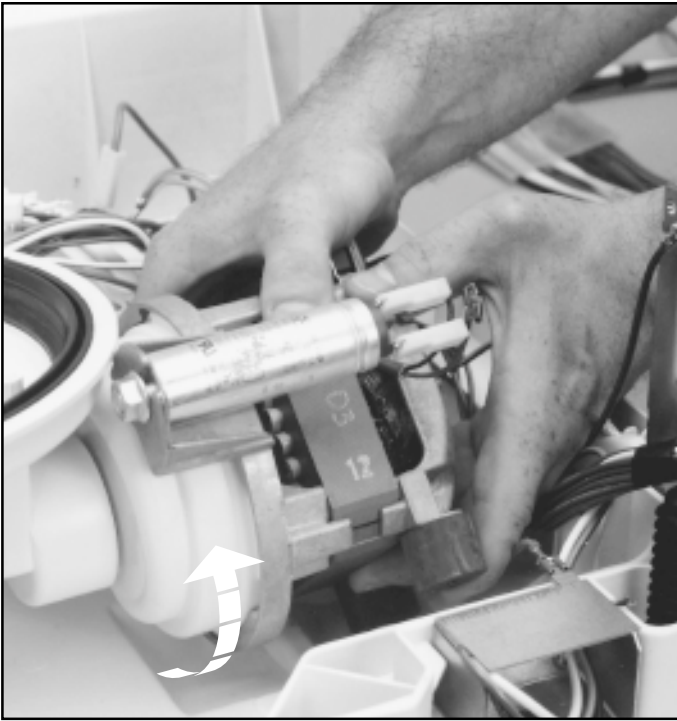

Fig. 16-2



Fig. 16-3

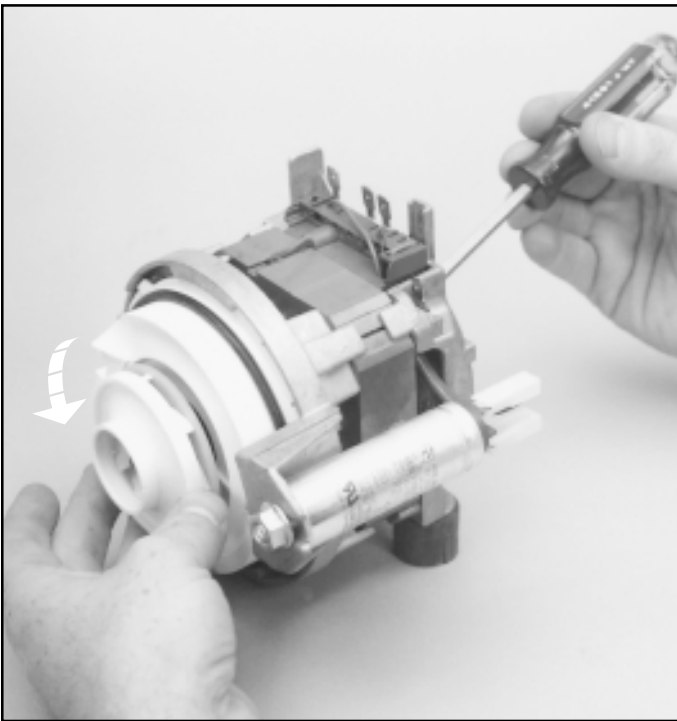

Fig. 16-4

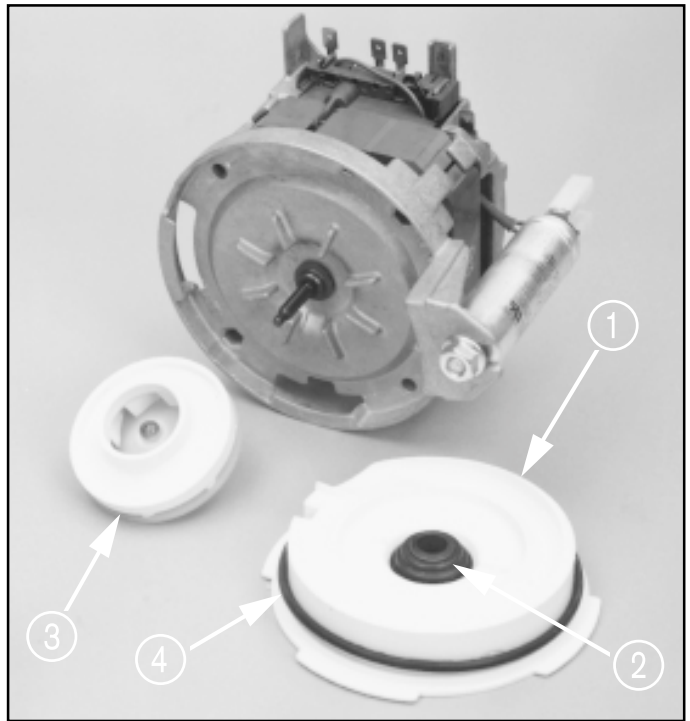

Fig. 16-5

Circulation Pump / Motor Assembly



Fig. 16-6

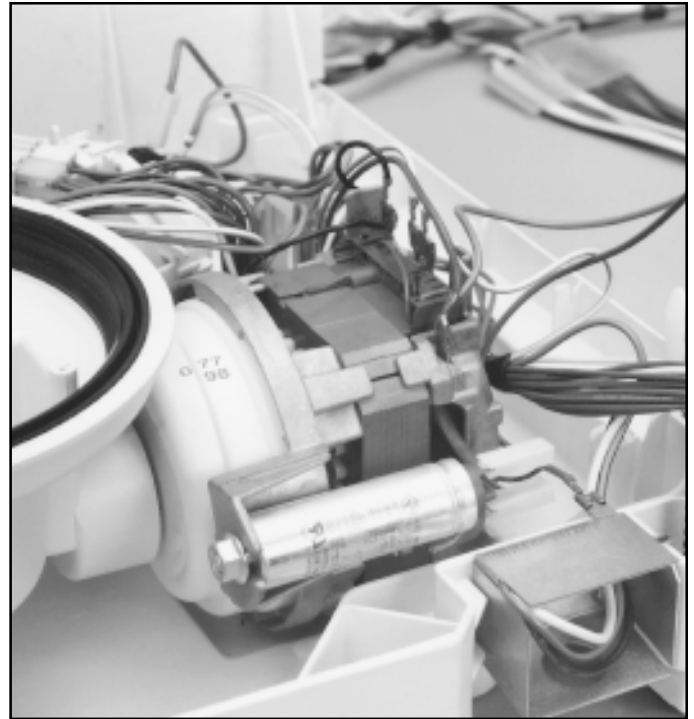

Fig. 16-7

CIRCULATION PUMP / MOTOR REMOVAL:

Disconnect the four wire leads, then grasp the Circulation Motor and turn clockwise a quarter turn until the Motor stops, Fig. 16-2. Now, remove the Motor / Rear Pump Assembly from the Front Pump Housing, Fig. 16-3.

Note: The Front Pump Housing remains in place when the Motor is removed, Fig.16-3, item 1.

With the Motor / Rear Pump Assembly removed from the unit, separate the Motor from the Rear Pump Assembly. To do so, first remove the Impeller by placing a block in the rear of the Motor and then turning the Impeller counter-clockwise, then Fig 16-4.

The Rear Pump Assembly consists of four components, Fig. 16-5:

- | | |
|-----------------------|-------------------|
| 1. Rear Pump Housing. | 3. Impeller. |
| 2. Main Pump Seal. | 4. Impeller Seal. |

Each component can be replaced as an individual item.

TO INSTALL:

First, locate the Key Square on the Front Pump Housing, Fig. 16-6. Next, locate the Key Square Cut Out on the Rear Pump Housing, Fig. 16-3, item 2.

When replacing the Pump / Motor make sure to line up the Key Square with the Key Square Cut Out. Then bring the two pump halves together in the position shown in Fig. 16-2, and turn the Motor clockwise until it stops, see Fig. 16-7.

Service note: The Impeller Seal Spring is compressed when the two halves of the Pump Assembly are brought together. This will take a little force, so make sure to have a good grip on the Sump as you compress the spring.

Now, reattach the wiring leads, test and check for leaks.

Heater Assembly Removal



Fig. 16-8

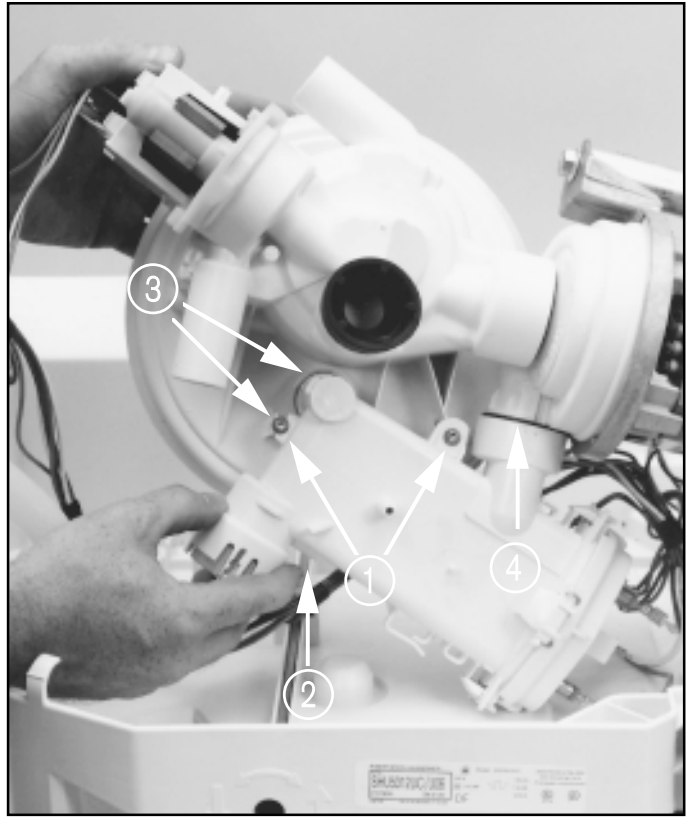

Fig. 16-9

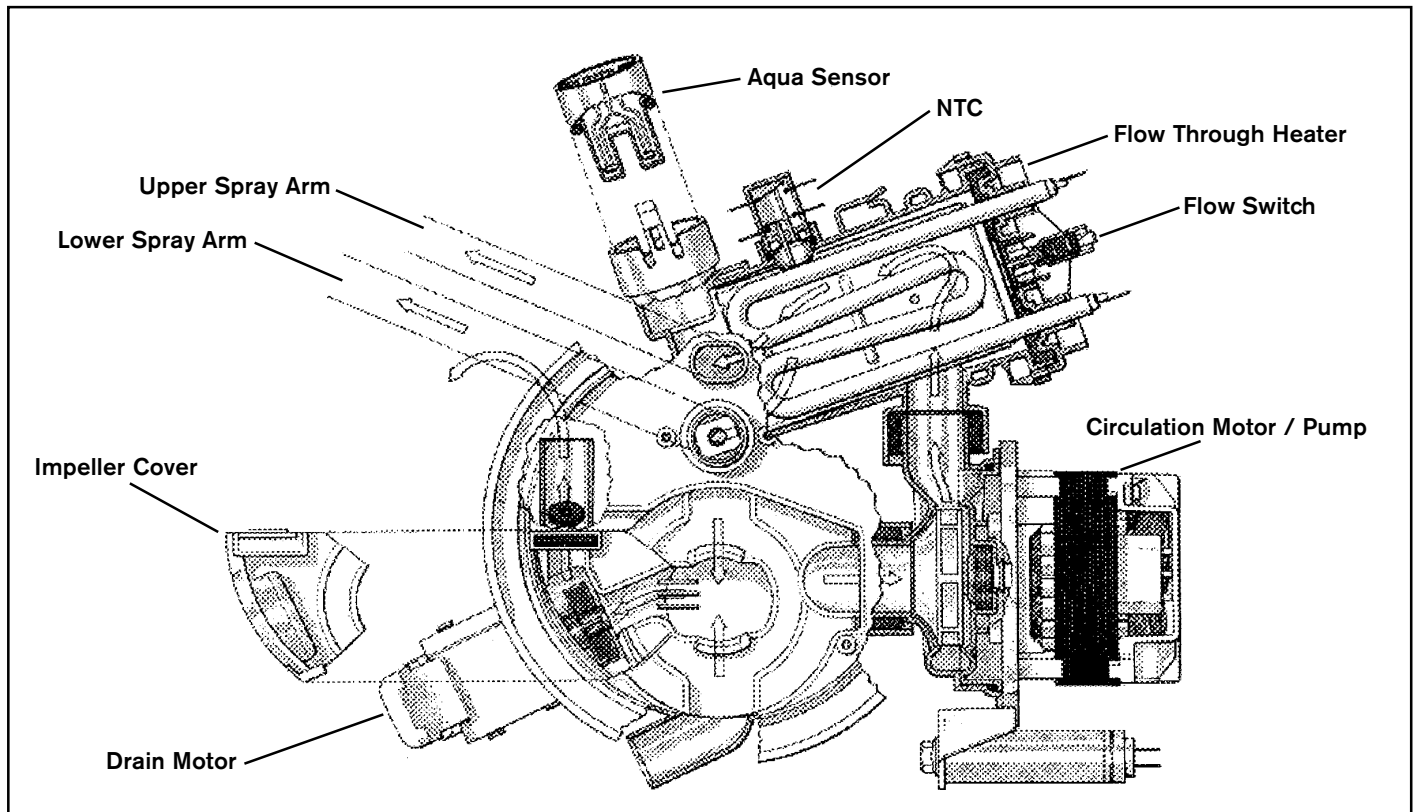

Fig. 16-10

Heater Assembly

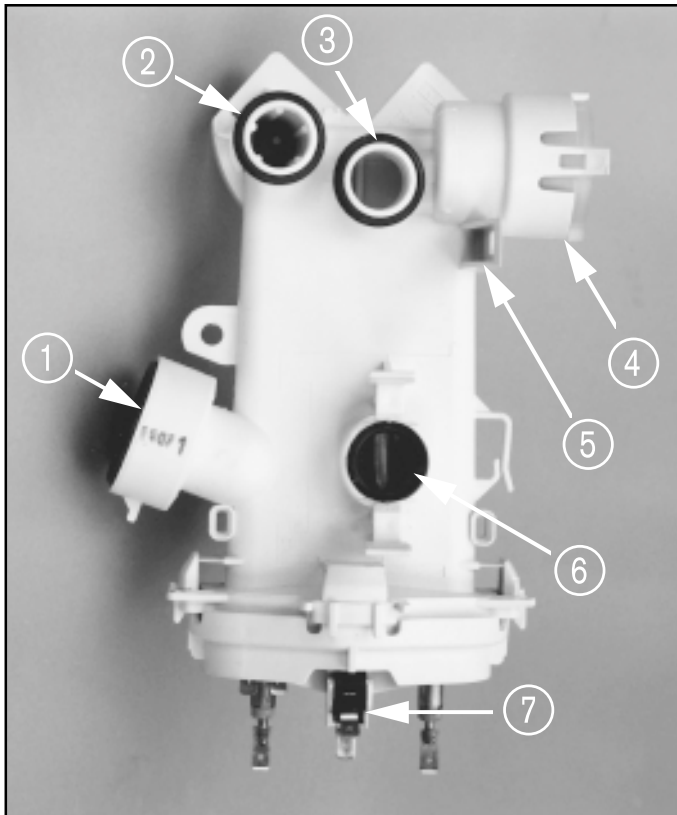

Fig. 16-11

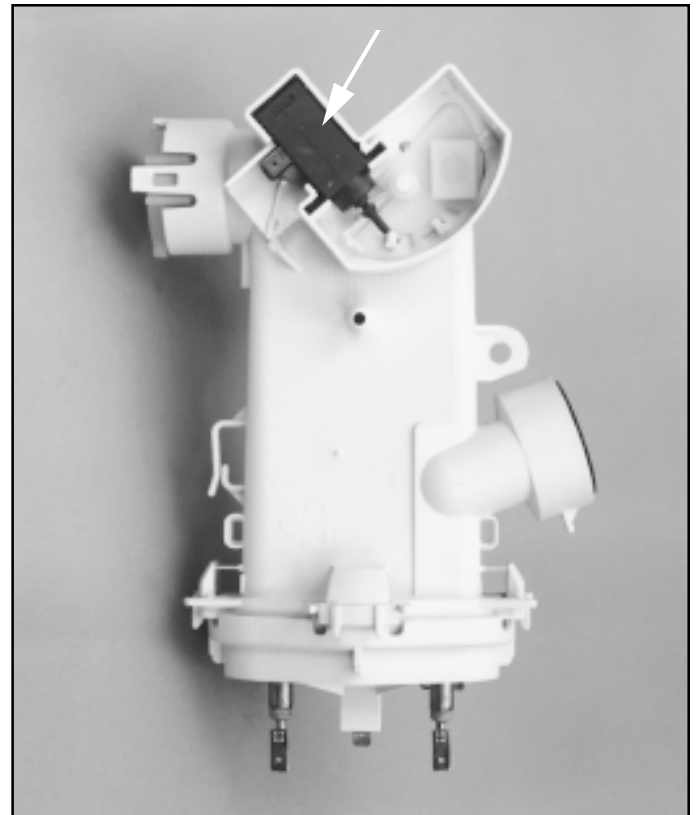

Fig. 16-12

The Heater Assembly, Fig. 16-8 is a flow through design, taking water in from the Circulation Pump and then sending it out the two discharge outlets to the Upper and Lower Spray Arms, Fig. 16-10.

HEATER ASSEMBLY REMOVAL:

See Fig. 16-9, first remove all wiring leads and the two securing screws, item 1.

Now, release the Heater Assembly Locking Tab, item 2, and while holding the tab open bring the Heater Assembly up on the left side, disengaging the heaters two discharge outlets from the Sump, item 3, and then out from the Circulation Pump Connection, item 4.

Heater Assembly Components, Fig. 16-11.

- | | |
|----------------------------------|----------------|
| 1. Intake from Circulation Pump. | 5. Locking Tab |
| 2. Discharge to Lower Spray Arm. | 6. NTC Socket |
| 3. Discharge to Upper Spray Arm. | 7. Flow Switch |
| 4. Aqua Sensor (if equipped). | |

TO INSTALL:

Slide the Heater Assembly into the Circulation Pump Connection first, then bring the Heater down and seat the two outlet gaskets back into the Sump. Make sure all three gaskets are secure and the locking tab is in place. Then replace the two screws and wiring connections.

Top Rack Actuator, Fig. 16-12.

Top Rack Actuator is used to activate the Top Rack Only wash on models equipped with this feature. When activated, the Top Rack Actuator diverts all water flow to the Upper Spray Arm.

To remove the Actuator, remove the wire connector, and then pry the Actuator out from its housing. When installing, make sure the Actuator's arm is properly inserted back into the Control Gate.

Aqua Sensor



Fig. 16-13

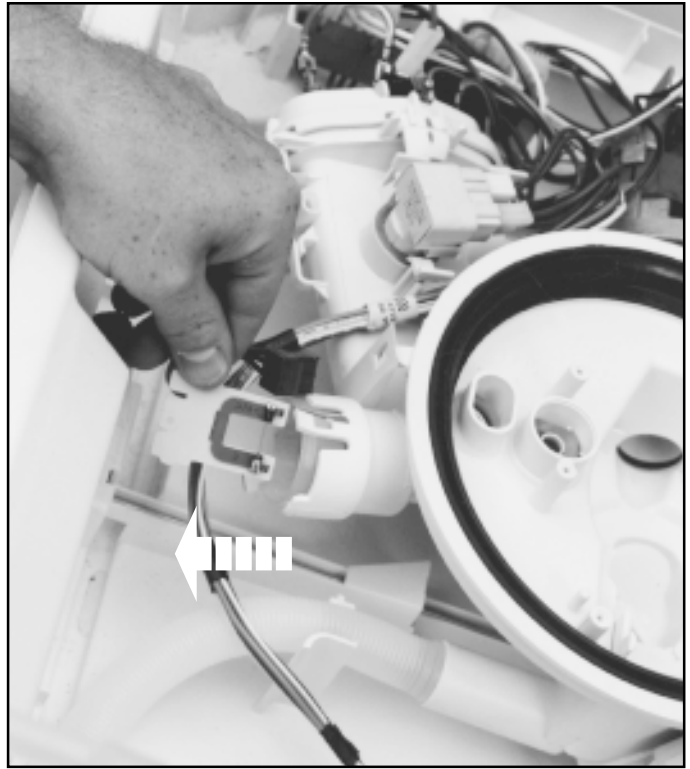

Fig. 16-14

The Aqua Sensor turbidity measuring device, Fig. 16-13, which is available only on select models, evaluates the pre-wash water using a beam of light and a pick-up sensor.

If the beam passes easily through the pre-wash water then no additional wash water is added. If the beam cannot pass through, then the pre-wash water is drained and a fresh fill is added for the main wash cycle.

To replace the sensor, Fig. 16-14, slide it out from its housing located on the Heater Assembly.

Service note: Since the Aqua Sensor has no effect on washability, it should never be replaced. Only if a leak were to occur should service be performed on this component.

Door Spring Removal

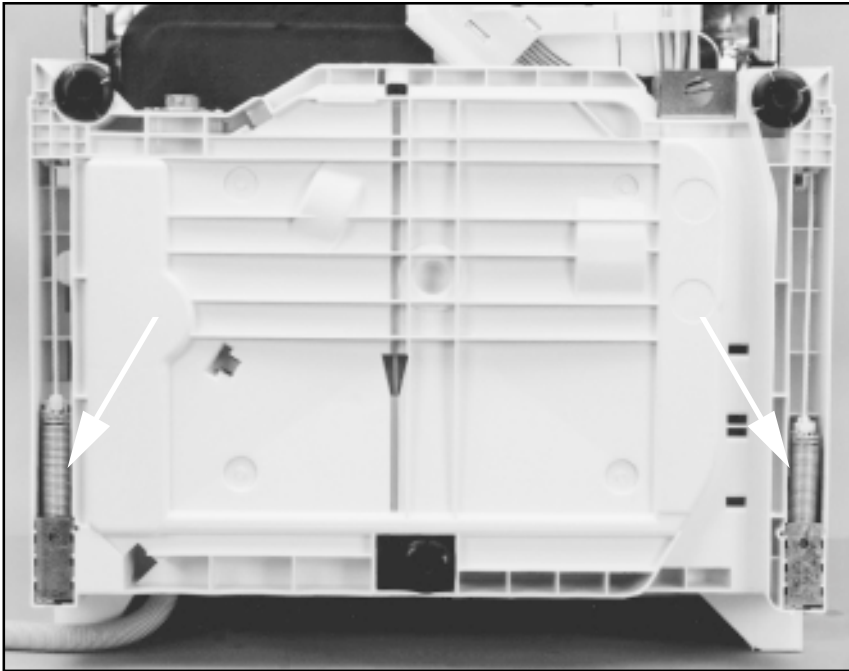

Fig. 16-15

The Door Springs are located on the bottom of the Base, Fig. 16-15, and operate via a Spring Cable and Reel that counter balances the weight of the Outer Door, Fig. 16-16.

If a Door Panel Kit is applied to the dishwasher, the factory springs must be replaced with the heavy duty version that is provided with the panel kit.

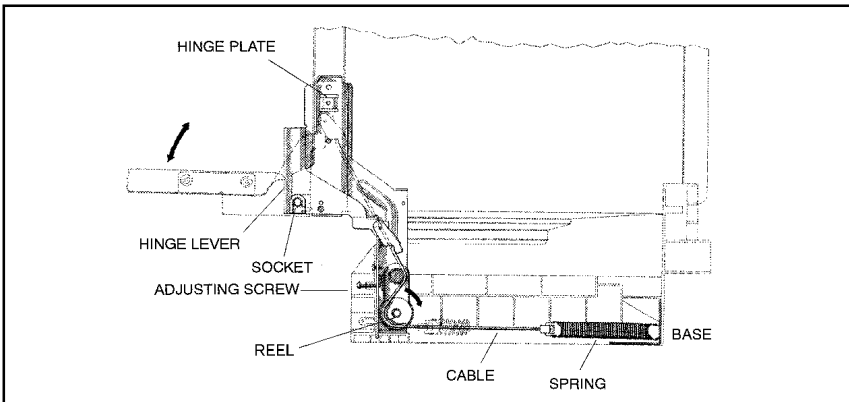

Fig. 16-16

TO REPLACE THE SPRINGS:

Lay the dishwasher on its back, being careful not to damage the Drain Hose. Then using a small screwdriver, remove the Door Springs by prying the Spring Plate out from the Base, Fig. 16-17.

Then remove the Spring Cable by unhooking it from the Spring, Fig. 16-18.



Fig. 16-17



Fig. 16-18

Notes

Section 9

Description	Page
Wiring Diagrams / Schematics	Page 72 – 84
Description	Diagrams
Test Program	1
SHI 4302	
SHI 4306	1, 8, 9
SHI 6802	
SHI 6805	
SHI 6806	1, 8, 11
SHU 3002	
SHU 3006	
SHU 3012	
SHU 3016	2, 3, 4
SHU 4002	
SHU 4006	
SHU 4016	
SHU 4022	
SHU 4026	
SHU 4036	5, 6, 7
SHU 4302	
SHU 4306	
SHU 4312	
SHU 4316	1, 8, 9
SHU 5302	
SHU 5304	
SHU 5305	
SHU 5306	
SHU 5312	
SHU 5314	
SHU 5315	
SHU 5316	1, 8, 10
SHU 6802	
SHU 6805	
SHU 6806	1, 8, 11
SHV 4303	
SHV 4803	12, 13

Diagram 1

FUNCTION	DURATION	COMMENTS
DRAINING	30 Seconds	
AQUA SENSOR CALIBRATION	65 Seconds	Not used on the SHI/U 43--
FILLING	Until Water Level Switch (f1) Closes.	This function cannot be bypassed
HEATING & CIRCULATING	Until Water Temperature Reaches 150° f.	Dispenser Actuator Energizes
DRAINING	60 Seconds	

• To bypass a function: SHI/U 43-- Press the SCRUB WASH button

SHI/U 53--/68-- Press the REGULAR WASH button.

SHI/U 43– MODELS

To begin the test program, press the POWER SCRUB PLUS and REGULAR WASH buttons both in at the same time as you turn the unit on by pressing the ON/OFF button. When released the LED's for the two programs will begin flashing.

To check all LED indicator lamps press the SCRUB WASH button.

To start the test program, press the POWER SCRUB PLUS and REGULAR WASH buttons both in a second time.

When the test program is complete, if a fault is detected the following indicator LED's will be illuminated.

WASH = Heating Fault
 RINSE/DRY = Filling Fault
 CLEAN = NTC Fault

SHU 53– or SHI/U 68– MODELS

To begin the test program, press the SCRUB WASH and DELICATE/ECONO buttons both in at the same time as you turn the unit on by pressing the ON/OFF button. The version number of the circuit board will appear in the display, 20, 21, etc.

When released the LED's for the two programs will begin flashing.

The check each LED press the corresponding program button. To check the countdown display and refill rinse aid LED press the REGULAR WASH button.

To start the test program, press the SCRUB WASH and DELICATE/ECONO buttons both in a second time.

When the test program is complete, the countdown display will indicate a fault or combination of faults using the following codes. If a combination of faults exists, the code numbers are added together. (6 = faults 2 + 4).

0 = No Faults
 1 = Aqua Sensor Fault
 2 = Heating Fault
 4 = Filling Fault
 8 = NTC Fault

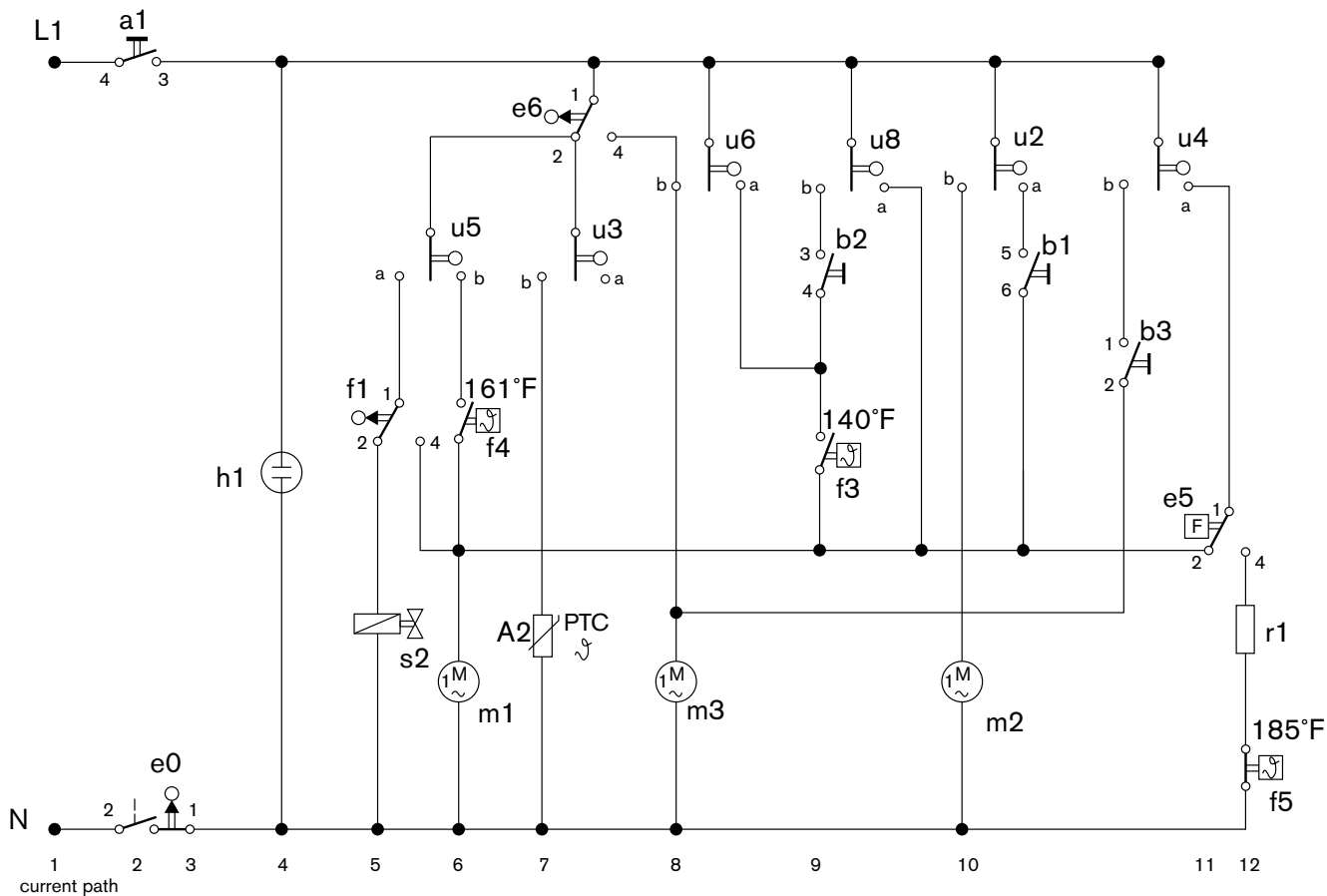

permanent split capacitor motor

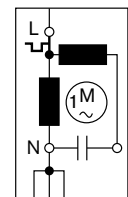

Symbol Key		Selector Switch Contacts	
a1	MAIN SWITCH	b1 & b3	POWER SCRUB
A2	ACTUATOR (Dispenser)	b1 & b2	REGULAR
e0	DOOR SWITCH	b3	RINSE & HOLD
e5	FLOW SWITCH		
e6	FLOAT SWITCH		
f1	WATER LEVEL SWITCH		
f3	THERMOSTAT 140°F		
f4	THERMOSTAT 161°F		
f5	HIGH LIMIT 185°F		
h1	ON/OFF LAMP		
m1	TIMER MOTOR		
m2	CIRCULATION MOTOR		
m3	DRAIN MOTOR		
r1	HEATING ELEMENT		
s2	WATER SOLENOID		
u-	TIMER CONTACTS		

Diagram 2

Timer - u

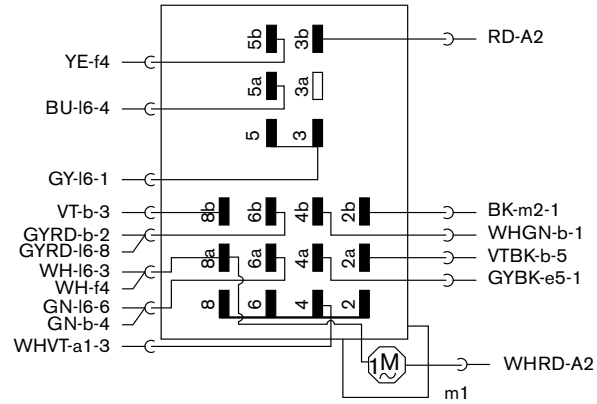

On / Off Switch - a1
Door Switch - e0

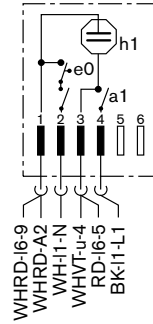

Selector Switch - b

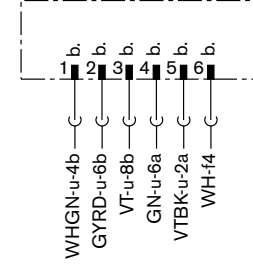

Wiring Connector - l6

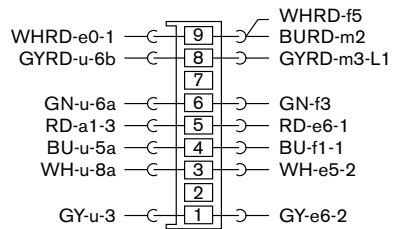

Drain Motor - m3

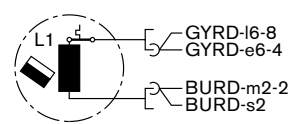

Float Switch - e6

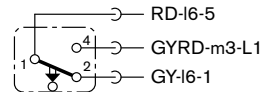

Thermostat - f4

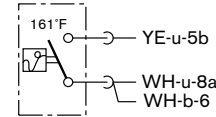

Actuator - A2

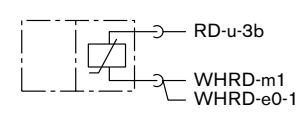

Water Solenoid - s2

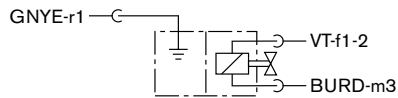

Water Level Switch - f1

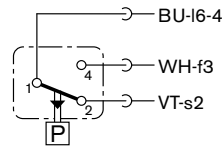

Flow Switch - e5

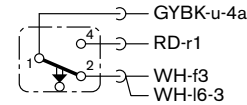

Ground - PE

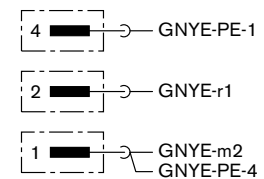

Thermostat - f3 & f5

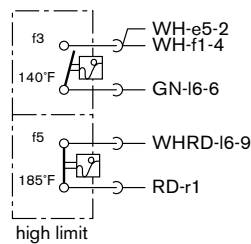

Circulation Motor - m2

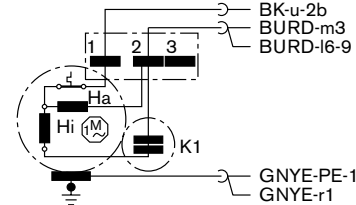

BK	=	black
BN	=	brown
RD	=	red
YE	=	yellow
GN	=	green
BU	=	blue
VT	=	violet
GY	=	grey
WH	=	white
PK	=	pink

Electrical Supply - l1

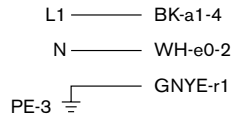

Heating Element - r1

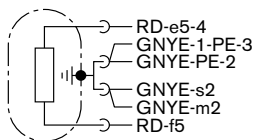

Timer - u

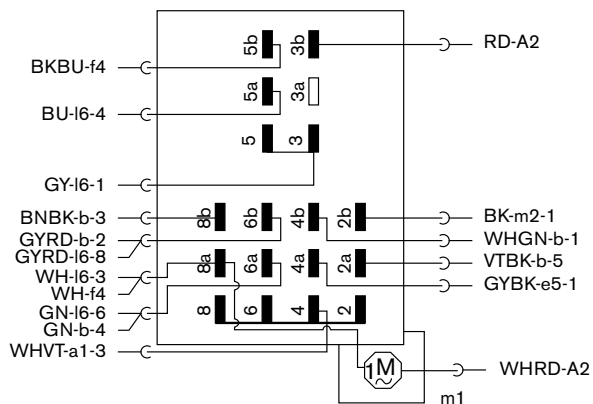

On / Off Switch - a1
Door Switch - e0

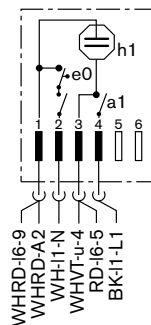

Selector Switch - b

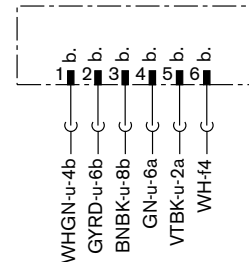

Wiring Connector - I6

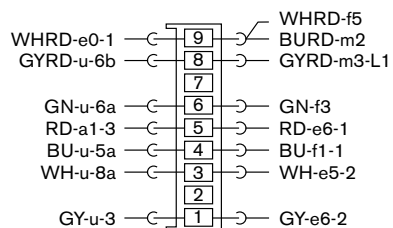

Drain Motor - m3

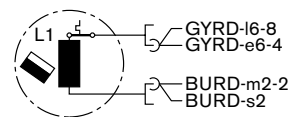

Float Switch - e6

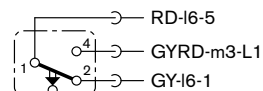

Thermostat - f4

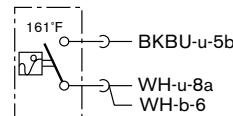

Actuator - A2

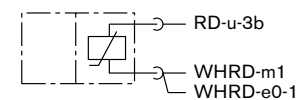

Water Solenoid - s2

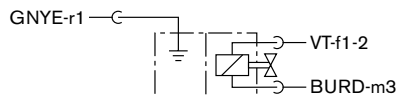

Water Level Switch - f1

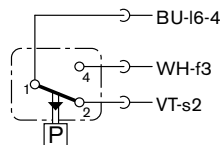

Flow Switch - e5

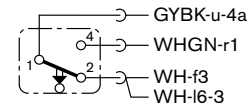

Ground - PE

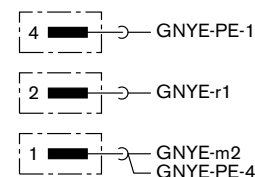

Thermostat - f3 & f5

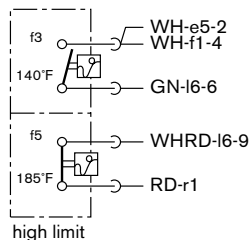

Circulation Motor - m2

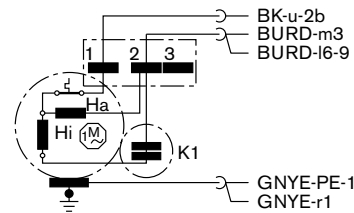

BK	=	black
BN	=	brown
RD	=	red
YE	=	yellow
GN	=	green
BU	=	blue
VT	=	violet
GY	=	grey
WH	=	white
PK	=	pink

Electrical Supply - I1

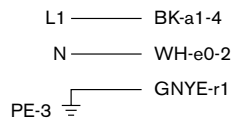

Heating Element - r1

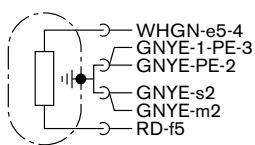

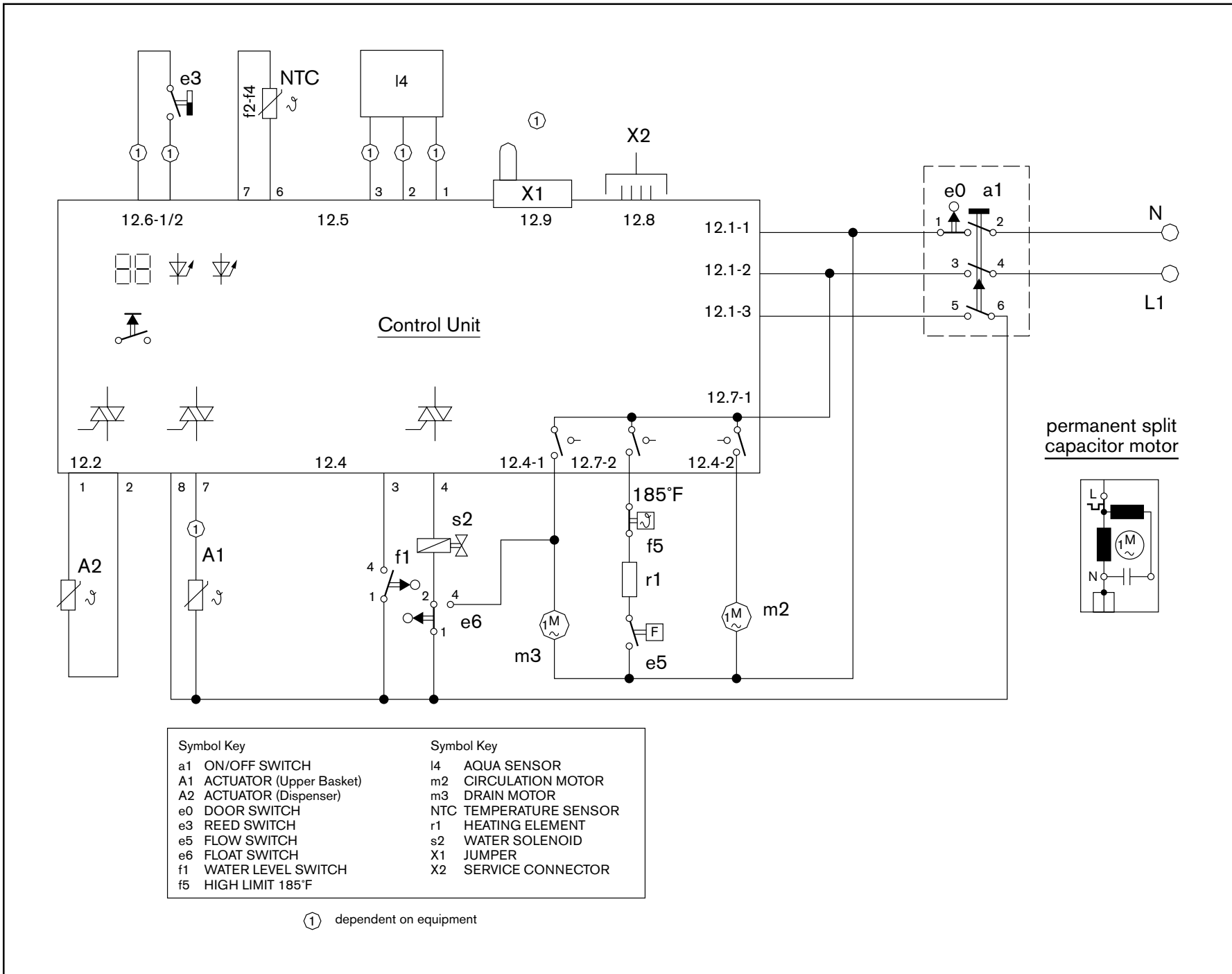

Symbol Key	
a1	ON/OFF SWITCH
A1	ACTUATOR (Upper Basket)
A2	ACTUATOR (Dispenser)
e0	DOOR SWITCH
e3	REED SWITCH
e5	FLOW SWITCH
e6	FLOAT SWITCH
f1	WATER LEVEL SWITCH
f5	HIGH LIMIT 185°F
I4	AQUA SENSOR
m2	CIRCULATION MOTOR
m3	DRAIN MOTOR
NTC	TEMPERATURE SENSOR
r1	HEATING ELEMENT
s2	WATER SOLENOID
X1	JUMPER
X2	SERVICE CONNECTOR

① dependent on equipment

Diagram 8

Control Unit – I2

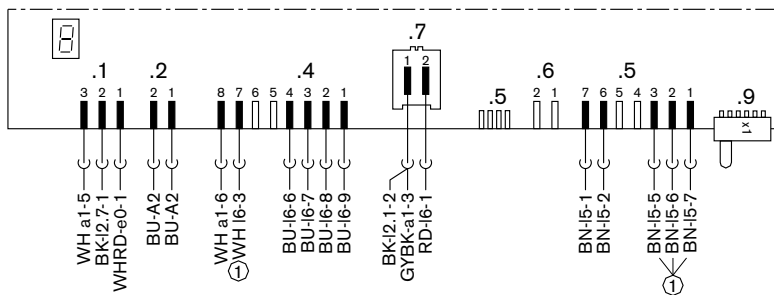

Ground – PE

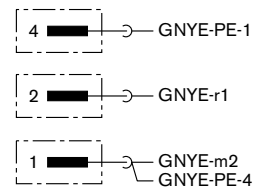

**On/Off Switch – a1
Door Switch – e0**

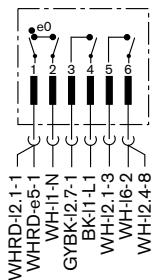

Water Level Switch – f1

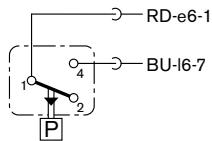

NTC – f2 & f4 / Thermostat – f5

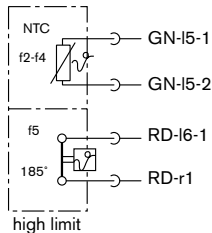

Actuator – A2

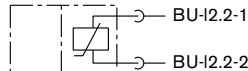

Wiring Connectors – I5 & I6

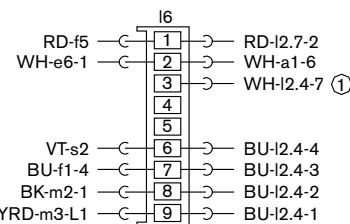
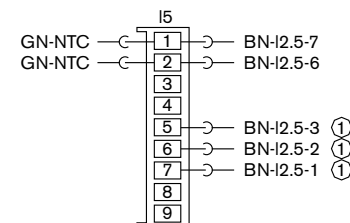

Float switch – e6

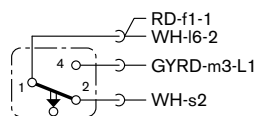

Water Solenoid – s2

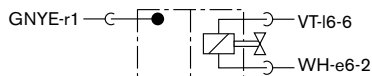

Circulation Motor – m2

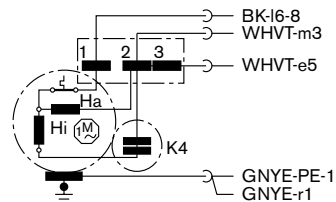

Electrical Supply – I1

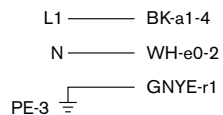

Heating Element – r1

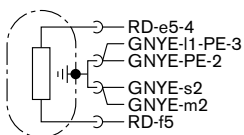

Flow Switch – e5

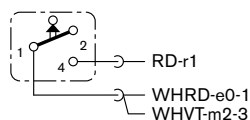

Drain Motor – m3

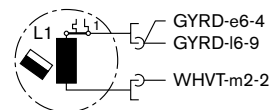

BK	=	black
BN	=	brown
RD	=	red
YE	=	yellow
GN	=	green
BU	=	blue
VT	=	violet
GY	=	grey
WH	=	white
PK	=	pink

① may exist without function

Control Unit – I2

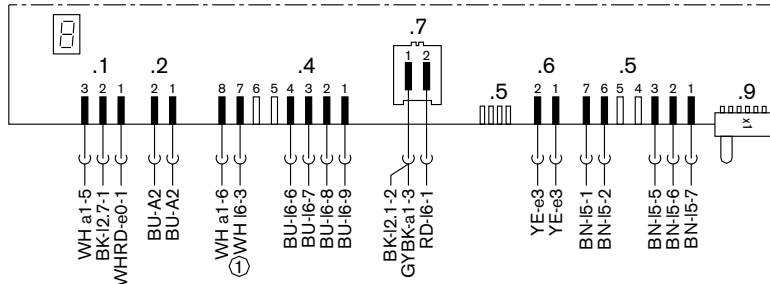

Reed Switch – e3

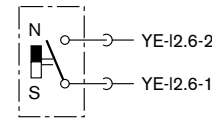

Ground – PE

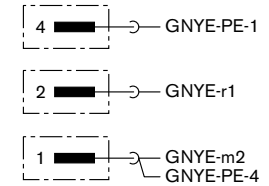

Wiring Connectors – I5 & I6

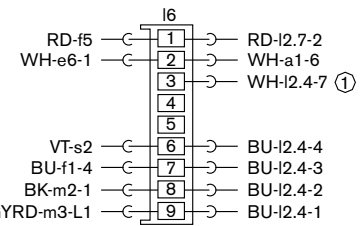
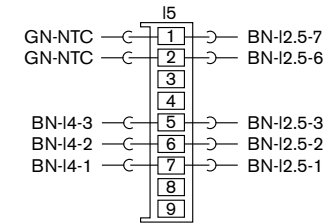

**On/Off Switch – a1
Door Switch – e0**

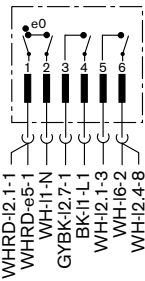

Water Level Switch – f1

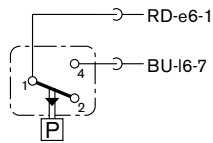

NTC – f2 & f4 / Thermostat – f5

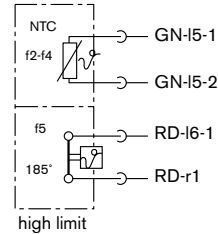

Aqua Sensor – I4



Water Solenoid – s2

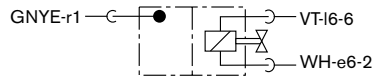

Circulation Motor – m2

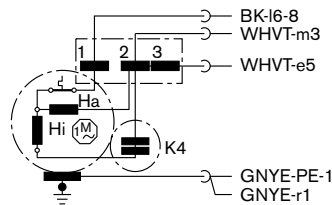

Actuator – A2

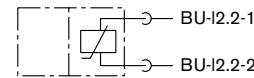

Float Switch – e6

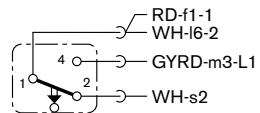

Electrical Supply – I1

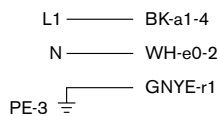

Heating Element – r1

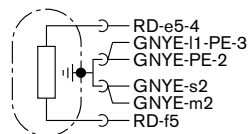

Flow Switch – e5

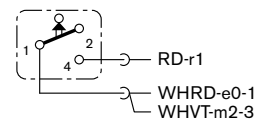

Drain Motor – m3

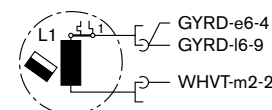

BK	=	black
BN	=	brown
RD	=	red
YE	=	yellow
GN	=	green
BU	=	blue
VT	=	violet
GY	=	grey
WH	=	white
PK	=	pink

① may exist without function

Control Unit – I2

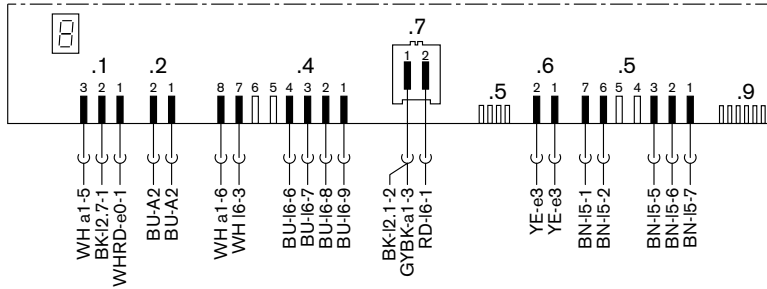

Reed Switch – e3

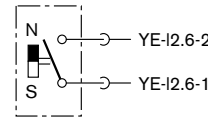

Ground – PE

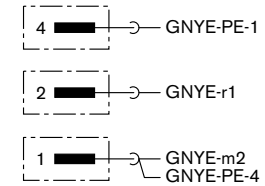

**On/Off Switch – a1
Door Switch – e0**

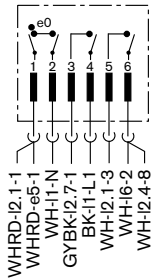

Water Level Switch – f1

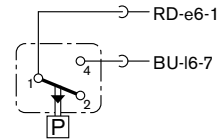

NTC – f2 & f4 / Thermostat f5

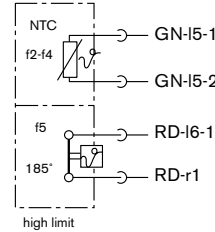

Aqua Sensor – I4



Wiring Connectors – I5 & I6

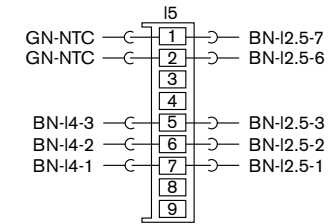

Water Solenoid – s2

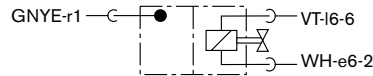

Actuators – A1 & A2

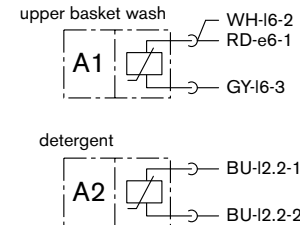

Float Switch – e6

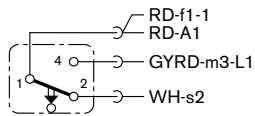

Circulation Motor – m2

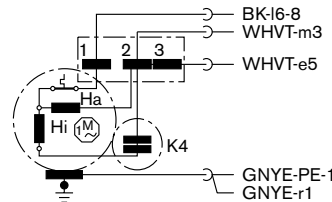

Electrical Supply – I1

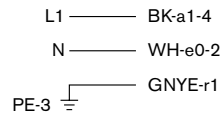

Heating Element – r1

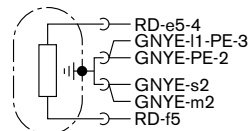

Flow Switch – e5

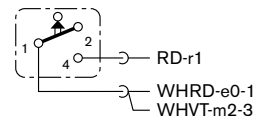

Drain Motor – m3

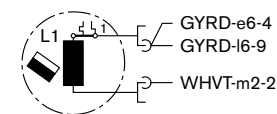

BK	=	black
BN	=	brown
RD	=	red
YE	=	yellow
GN	=	green
BU	=	blue
VT	=	violet
GY	=	grey
WH	=	white
PK	=	pink

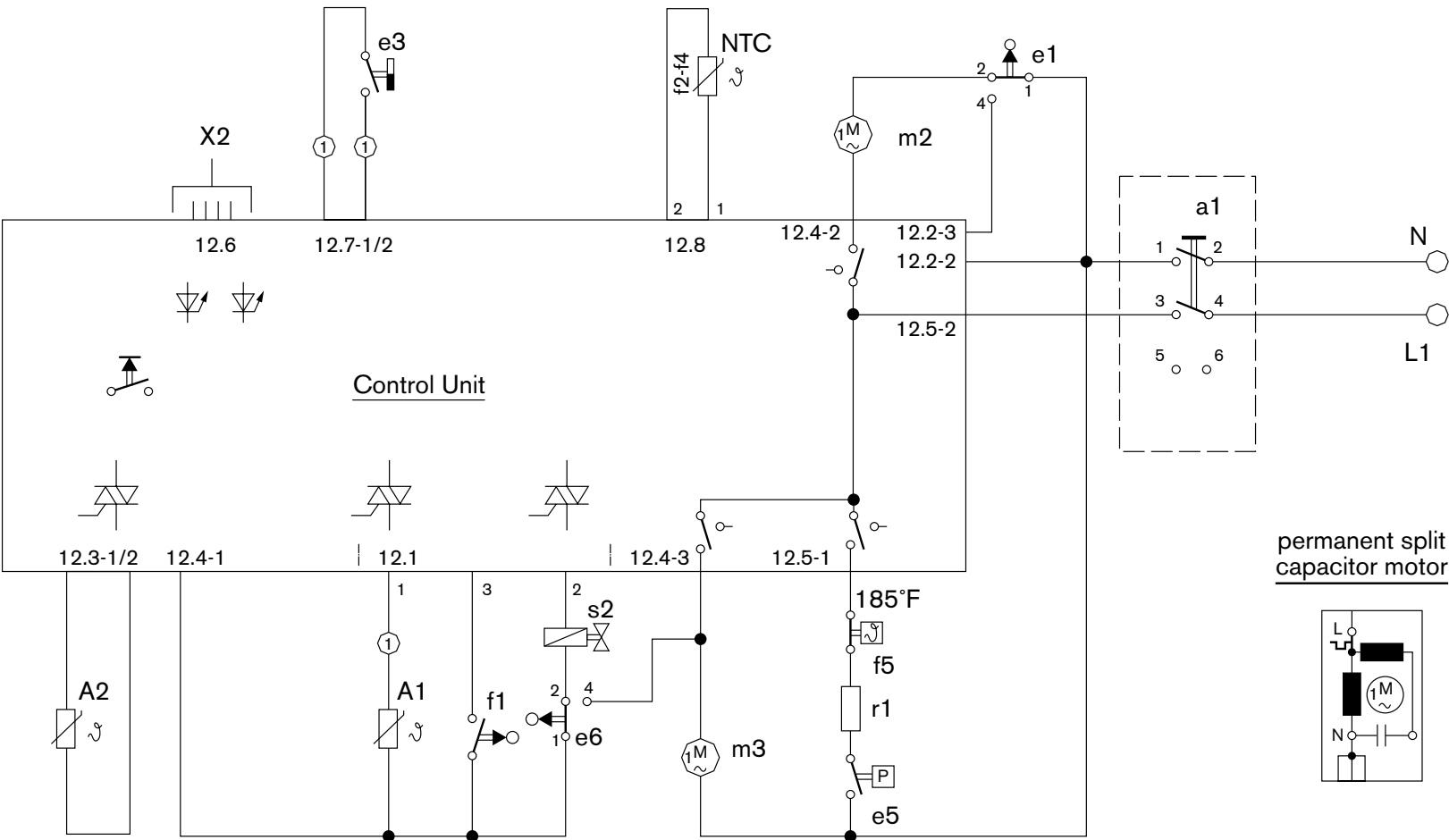

permanent split capacitor motor

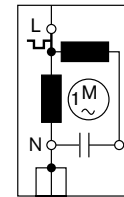

Symbol Key	
a1	ON/OFF SWITCH
A1	ACTUATOR (Upper Basket)
A2	ACTUATOR (Dispenser)
e0	DOOR SWITCH
e3	REED SWITCH
e5	FLOW SWITCH
e6	FLOAT SWITCH
f1	WATER LEVEL SWITCH
f5	HIGH LIMIT 185°F
Symbol Key	
I4	AQUA SENSOR
m2	CIRCULATION MOTOR
m3	DRAIN MOTOR
NTC	TEMPERATURE SENSOR
r1	HEATING ELEMENT
s2	WATER SOLENOID
X1	JUMPER
X2	SERVICE CONNECTOR

① SHV 4803 only

On/Off Switch – a1
Door Switch – e0

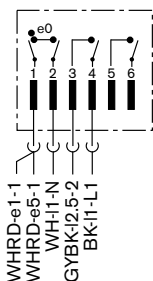

Control Unit – I2

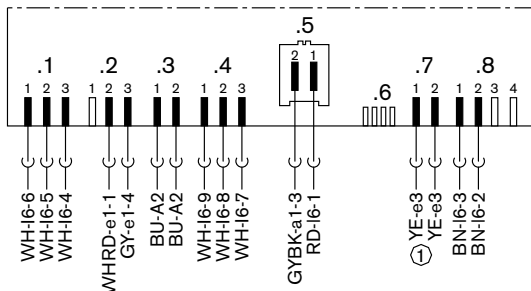

Door Switch – e1

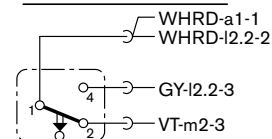

Reed Switch – e3 ①

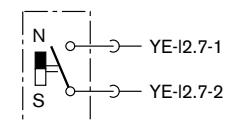

Ground – PE



Water Level Switch – f1

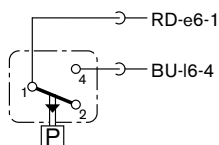

NTC – f2 & f4 / Thermostat – f5

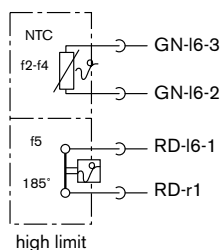

Actuators – A1 & A2

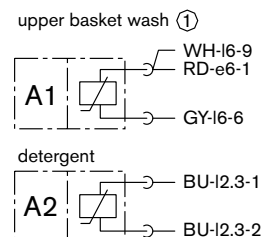

Wiring Connector – I6

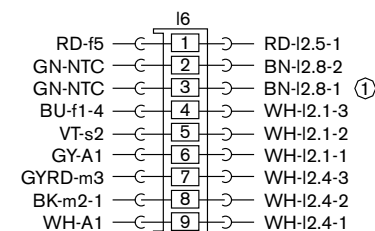

Float Switch – e6

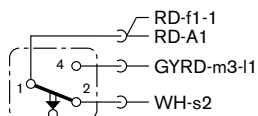

Water Solenoid – s2

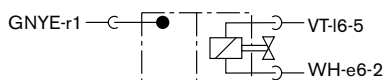

Circulation Motor – m2

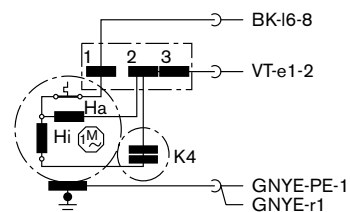

Electrical Supply – I1

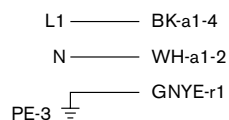

Heating Element – r1

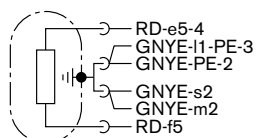

Flow Switch – e5

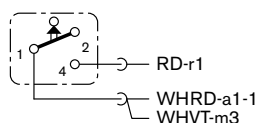

Drain Motor – m3

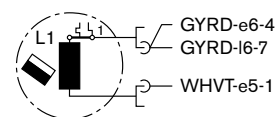

- BK = black
- BN = brown
- RD = red
- YE = yellow
- GN = green
- BU = blue
- VT = violet
- GY = grey
- WH = white
- PK = pink

① SHV 4803 only

BSH Home Appliances
2800 South 25th Avenue
Broadview, Illinois 60153