

## Introduction

This data sheet module describes the various pins on a Spartan™-3 FPGA and how they connect to the supported component packages.

- The **Pin Types** section categorizes all of the FPGA pins by their function type.
- The **Pin Definitions** section provides a top-level description for each pin on the device.
- The **Detailed, Functional Pin Descriptions** section offers significantly more detail about each pin, especially for the dual- or special-function pins used during device configuration.
- Some pins have associated optional behavior, controlled by settings in the configuration bitstream. These options are described in the **Bitstream Options** section.

- The **Package Overview** section describes the various packaging options available for Spartan-3 FPGAs. Detailed pin list tables and footprint diagrams are provided for each package solution.

## Pin Descriptions

### Pin Types

A majority of the pins on a Spartan-3 FPGA are general-purpose, user-defined I/O pins. There are, however, up to 12 different functional types of pins on Spartan-3 packages, as outlined in **Table 1**. In the package footprint drawings that follow, the individual pins are color-coded according to pin type as in the table.

Table 1: Types of Pins on Spartan-3 FPGAs

Type/ Color Code	Description	Pin Name(s) in Type
I/O	Unrestricted, general-purpose user-I/O pin. Most pins can be paired together to form differential I/Os.	IO, IO_Lxxy_#
DUAL	Dual-purpose pin used in some configuration modes during the configuration process and then usually available as a user I/O after configuration. If the pin is not used during configuration, this pin behaves as an I/O-type pin. There are 12 dual-purpose configuration pins on every package.	IO_Lxxy_#/DIN/D0, IO_Lxxy_#/D1, IO_Lxxy_#/D2, IO_Lxxy_#/D3, IO_Lxxy_#/D4, IO_Lxxy_#/D5, IO_Lxxy_#/D6, IO_Lxxy_#/D7, IO_Lxxy_#/CS_B, IO_Lxxy_#/RDWR_B, IO_Lxxy_#/BUSY/DOUT, IO_Lxxy_#/INIT_B
CONFIG	Dedicated configuration pin. Not available as a user-I/O pin. Every package has seven dedicated configuration pins. These pins are powered by VCCAUX.	CCLK, DONE, M2, M1, M0, PROG_B, HSWAP_EN
JTAG	Dedicated JTAG pin. Not available as a user-I/O pin. Every package has four dedicated JTAG pins. These pins are powered by VCCAUX.	TDI, TMS, TCK, TDO
DCI	Dual-purpose pin that is either a user-I/O pin or used to calibrate output buffer impedance for a specific bank using Digital Controlled Impedance (DCI). There are two DCI pins per I/O bank.	IO/VRN_# IO_Lxxy_#/VRN_# IO/VRP_# IO_Lxxy_#/VRP_#
VREF	Dual-purpose pin that is either a user-I/O pin or, along with all other VREF pins in the same bank, provides a reference voltage input for certain I/O standards. If used for a reference voltage within a bank, all VREF pins within the bank must be connected.	IO/VREF_# IO_Lxxy_#/VREF_#

Table 1: Types of Pins on Spartan-3 FPGAs (Continued)

Type/ Color Code	Description	Pin Name(s) in Type
GND	Dedicated ground pin. The number of GND pins depends on the package used. All must be connected.	GND
VCCAUX	Dedicated auxiliary power supply pin. The number of VCCAUX pins depends on the package used. All must be connected to +2.5V.	VCCAUX
VCCINT	Dedicated internal core logic power supply pin. The number of VCCINT pins depends on the package used. All must be connected to +1.2V.	VCCINT
VCCO	Dedicated I/O bank, output buffer power supply pin. Along with other VCCO pins in the same bank, this pin supplies power to the output buffers within the I/O bank and sets the input threshold voltage for some I/O standards.	VCCO_# <b>TQ144 Package Only:</b> VCCO_LEFT, VCCO_TOP, VCCO_RIGHT, VCCO_BOTTOM
GCLK	Dual-purpose pin that is either a user-I/O pin or an input to a specific global buffer input. Every package has eight dedicated GCLK pins.	IO_Lxxy_#/GCLK0, IO_Lxxy_#/GCLK1, IO_Lxxy_#/GCLK2, IO_Lxxy_#/GCLK3, IO_Lxxy_#/GCLK4, IO_Lxxy_#/GCLK5, IO_Lxxy_#/GCLK6, IO_Lxxy_#/GCLK7
N.C.	This package pin is not connected in this specific device/package combination but may be connected in larger devices in the same package.	N.C.

**Notes:**

- # = I/O bank number, an integer between 0 and 7.

I/Os with Lxxy\_# are part of a differential output pair. 'L' indicates differential output capability. The "xx" field is a two-digit integer, unique to each bank that identifies a differential pin-pair. The 'y' field is either 'P' for the true signal or 'N' for the inverted signal in the differential pair. The '#' field is the I/O bank number.

**Pin Definitions**

Table 2 provides a brief description of each pin listed in the Spartan-3 pinout tables and package footprint diagrams. Pins are categorized by their pin type, as listed in Table 1. See **Detailed, Functional Pin Descriptions** for more information.

Table 2: Spartan-3 Pin Definitions

Pin Name	Direction	Description
I/O: General-purpose I/O pins		
I/O	User-defined as input, output, bidirectional, three-state output, open-drain output, open-source output	<b>User I/O:</b> Unrestricted single-ended user-I/O pin. Supports all I/O standards except the differential standards.
I/O_Lxxy_#	User-defined as input, output, bidirectional, three-state output, open-drain output, open-source output	<b>User I/O, Half of Differential Pair:</b> Unrestricted single-ended user-I/O pin or half of a differential pair. Supports all I/O standards including the differential standards.
<b>DUAL: Dual-purpose configuration pins</b>		
IO_Lxxy_#/DIN/D0, IO_Lxxy_#/D1, IO_Lxxy_#/D2, IO_Lxxy_#/D3, IO_Lxxy_#/D4, IO_Lxxy_#/D5, IO_Lxxy_#/D6, IO_Lxxy_#/D7	Input during configuration Possible bidirectional I/O after configuration if SelectMap port is retained. Otherwise, user I/O after configuration	<b>Configuration Data Port:</b> In Parallel (SelectMAP) modes, D0-D7 are byte-wide configuration data pins. These pins become user I/Os after configuration unless the SelectMAP port is retained via the Persist bitstream option. In Serial modes, DIN (D0) serves as the single configuration data input. This pin becomes a user I/O after configuration unless retained by the Persist bitstream option.
IO_Lxxy_#/CS_B	Input during Parallel mode configuration Possible input after configuration if SelectMap port is retained. Otherwise, user I/O after configuration	<b>Chip Select for Parallel Mode Configuration:</b> In Parallel (SelectMAP) modes, this is the active-Low Chip Select signal. This pin becomes a user I/O after configuration unless the SelectMAP port is retained via the Persist bitstream option.
IO_Lxxy_#/RDWR_B	Input during Parallel mode configuration Possible input after configuration if SelectMap port is retained. Otherwise, user I/O after configuration	<b>Read/Write Control for Parallel Mode Configuration:</b> In Parallel (SelectMAP) modes, this is the active-Low Write Enable, active-High Read Enable signal. This pin becomes a user I/O after configuration unless the SelectMAP port is retained via the Persist bitstream option.
IO_Lxxy_#/BUSY/DOUT	Output during configuration Possible output after configuration if SelectMap port is retained. Otherwise, user I/O after configuration	<b>Configuration Data Rate Control for Parallel Mode, Serial Data Output for Serial Mode:</b> In Parallel (SelectMAP) modes, BUSY throttles the rate at which configuration data is loaded. This pin becomes a user I/O after configuration unless the SelectMAP port is retained via the Persist bitstream option. In Serial modes, DOUT provides preamble and configuration data to downstream devices in a multi-FPGA daisy-chain. This pin becomes a user I/O after configuration.

Table 2: Spartan-3 Pin Definitions (Continued)

Pin Name	Direction	Description
IO_Lxxy_#/INIT_B	Bidirectional (open-drain) during configuration User I/O after configuration	<b>Initializing Configuration Memory/Detected Configuration Error:</b> When Low, this pin indicates that configuration memory is being cleared. When held Low, this pin delays the start of configuration. After this pin is released or configuration memory is cleared, the pin goes High. During configuration, a Low on this output indicates that a configuration data error occurred. This pin becomes a user I/O after configuration.
<b>DCI:</b> Digitally Controlled Impedance reference resistor input pins		
IO_Lxxy_#/VRN_# or IO/VRN_#	Input when using DCI Otherwise, same as I/O	<b>DCI Reference Resistor for NMOS I/O Transistor (per bank):</b> If using DCI, a 1% precision impedance-matching resistor is connected between this pin and the VCCO supply for this bank. Otherwise, this pin is a user I/O.
IO_Lxxy_#/VRP_# or IO/VRP_#	Input when using DCI Otherwise, same as I/O	<b>DCI Reference Resistor for PMOS I/O Transistor (per bank):</b> If using DCI, a 1% precision impedance-matching resistor is connected between this pin and the ground supply. Otherwise, this pin is a user I/O.
<b>GCLK:</b> Global clock buffer inputs		
IO_Lxxy_#/GCLK0, IO_Lxxy_#/GCLK1, IO_Lxxy_#/GCLK2, IO_Lxxy_#/GCLK3, IO_Lxxy_#/GCLK4, IO_Lxxy_#/GCLK5, IO_Lxxy_#/GCLK6, IO_Lxxy_#/GCLK7	Input if connected to global clock buffers Otherwise, same as I/O	<b>Global Buffer Input:</b> Direct input to a low-skew global clock buffer. If not connected to a global clock buffer, this pin is a user I/O.
<b>VREF:</b> I/O bank input reference voltage pins		
IO_Lxxy_#/VREF_# or IO/VREF_#	Voltage supply input when VREF pins are used within a bank. Otherwise, same as I/O	<b>Input Buffer Reference Voltage for Special I/O Standards (per bank):</b> If required to support special I/O standards, all the VREF pins within a bank connect to an input threshold voltage source. If not used as input reference voltage pins, these pins are available as individual user-I/O pins.
<b>CONFIG:</b> Dedicated configuration pins		
CCLK	Input in Slave configuration modes Output in Master configuration modes	<b>Configuration Clock:</b> The configuration clock signal synchronizes configuration data.
PROG_B	Input	<b>Program/Configure Device:</b> Active Low asynchronous reset to configuration logic. Asserting PROG_B Low for an extended period delays the configuration process. This pin has an internal weak pull-up resistor during configuration.

Table 2: Spartan-3 Pin Definitions (Continued)

Pin Name	Direction	Description
DONE	Bidirectional with open-drain or totem-pole Output	<p><b>Configuration Done, Delay Start-up Sequence:</b></p> <p>A Low-to-High output transition on this bidirectional pin signals the end of the configuration process.</p> <p>The FPGA produces a Low-to-High transition on this pin to indicate that the configuration process is complete. The DriveDone bitstream generation option defines whether this pin functions as a totem-pole output that actively drives High or as an open-drain output. An open-drain output requires a pull-up resistor to produce a High logic level. The open-drain option permits the DONE lines of multiple FPGAs to be tied together, so that the common node transitions High only after all of the FPGAs have completed configuration. Externally holding the open-drain output Low delays the start-up sequence, which marks the transition to user mode.</p>
M0, M1, M2	Input	<p><b>Configuration Mode Selection:</b></p> <p>These inputs select the configuration mode. The logic levels applied to the mode pins are sampled on the rising edge of INIT_B. See <a href="#">Table 7</a>.</p>
HSWAP_EN	Input	<p><b>Disable Weak Pull-up Resistors During Configuration:</b></p> <p>A Low on this pin enables weak pull-up resistors on all pins that are not actively involved in the configuration process. A High value disables all pull-ups, allowing the non-configuration pins to float.</p>
<b>JTAG: JTAG interface pins</b>		
TCK	Input	<p><b>JTAG Test Clock:</b></p> <p>The TCK clock signal synchronizes all JTAG port operations.</p>
TDI	Input	<p><b>JTAG Test Data Input:</b></p> <p>TDI is the serial data input for all JTAG instruction and data registers.</p>
TMS	Input	<p><b>JTAG Test Mode Select:</b></p> <p>The serial TMS input controls the operation of the JTAG port.</p>
TDO	Output	<p><b>JTAG Test Data Output:</b></p> <p>TDO is the serial data output for all JTAG instruction and data registers.</p>
<b>VCCO: I/O bank output voltage supply pins</b>		
VCCO_#	Supply	<p><b>Power Supply for Output Buffer Drivers (per bank):</b></p> <p>These pins power the output drivers within a specific I/O bank.</p>
<b>VCCAUX: Auxiliary voltage supply pins</b>		
VCCAUX	Supply	<p><b>Power Supply for Auxiliary Circuits:</b></p> <p>+2.5V power pins for auxiliary circuits, including the Digital Clock Managers (DCMs), the dedicated configuration pins (CONFIG), and the dedicated JTAG pins. All VCCAUX pins must be connected.</p>
<b>VCCINT: Internal core voltage supply pins</b>		
VCCINT	Supply	<p><b>Power Supply for Internal Core Logic:</b></p> <p>+1.2V power pins for the internal logic. All pins must be connected.</p>

Table 2: Spartan-3 Pin Definitions (Continued)

Pin Name	Direction	Description
<b>GND:</b> Ground supply pins		
GND	Supply	<b>Ground:</b> Ground pins, which are connected to the power supply's return path. All pins must be connected.
<b>N.C.:</b> Unconnected package pins		
N.C.		<b>Unconnected Package Pin:</b> These package pins are unconnected.

**Notes:**

- All unused inputs and bidirectional pins must be tied either High or Low. For unused enable inputs, apply the level that disables the associated function. One common approach is to activate internal pull-up or pull-down resistors. An alternative approach is to externally connect the pin to either VCCO or GND.
- All outputs are of the totem-pole type — i.e., they can drive High as well as Low logic levels — except for the cases where “Open Drain” is indicated. The latter can only drive a Low logic level and require a pull-up resistor to produce a High logic level.

## Detailed, Functional Pin Descriptions

### I/O Type: Unrestricted, General-purpose I/O Pins

After configuration, I/O-type pins are inputs, outputs, bidirectional I/O, three-state outputs, open-drain outputs, or open-source outputs, as defined in the application.

Pins labeled "IO" support all SelectIO™ signal standards except differential standards. A given device at most only has a few of these pins.

A majority of the general-purpose I/O pins are labeled in the format “IO\_L<sub>xy</sub>\_<sub>#</sub>”. These pins support all SelectIO signal standards, including the differential standards such as LVDS, ULVDS, BLVDS, RSDS, or LDT.

For additional information, see the [“IOB” section under Functional Description \(Module 2 of the Spartan-3 data sheet\)](#).

### Differential Pair Labeling

A pin supports differential standards if the pin is labeled in the format “L<sub>xy</sub>\_<sub>#</sub>”. The pin name suffix has the following significance. [Figure 1](#) provides a specific example showing a differential input to and a differential output from Bank 2.

- ‘L’ indicates differential capability.
- “xx” is a two-digit integer, unique for each bank, that identifies a differential pin-pair.
- ‘y’ is replaced by ‘P’ for the true signal or ‘N’ for the inverted. These two pins form one differential pin-pair.
- ‘#’ is an integer, 0 through 7, indicating the associated I/O bank.

If unused, these pins are in a high impedance state. The Bitstream generator option UnusedPin enables a weak pull-up or pull-down resistor on all unused I/O pins.

### Behavior from Power-On through End of Configuration

During the configuration process, all pins that are not actively involved in the configuration process are in a high-impedance state. The HSWAP\_EN input determines whether or not weak pull-up resistors are enabled during configuration. HSWAP\_EN = 0 enables the weak pull-up resistors. HSWAP\_EN = 1 disables the pull-up resistors allowing the pins to float, which is the desired state for hot-swap applications.

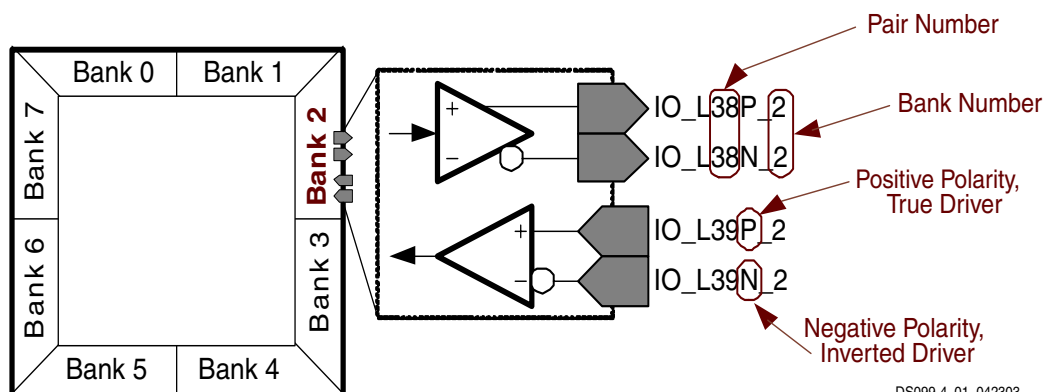

DS099-4\_01\_042303

Figure 1: Differential Pair Labelling

## DUAL Type: Dual-Purpose Configuration and I/O Pins

These pins serve dual purposes. The user-I/O pins are temporarily borrowed during the configuration process to load configuration data into the FPGA. After configuration, these pins are then usually available as a user I/O in the application. If a pin is not applicable to the specific configuration mode—controlled by the mode select pins M2, M1, and M0—then the pin behaves as an I/O-type pin.

There are 12 dual-purpose configuration pins on every package, six of which are part of I/O Bank 4, the other six part of I/O Bank 5. Only a few of the pins in Bank 4 are used in the Serial configuration modes.

See [“Configuration” under Functional Description \(Module 2 of the Spartan-3 data sheet\)](#).

See [“Pin Behavior During Configuration, page 15”](#).

## Serial Configuration Modes

This section describes the dual-purpose pins used during either Master or Slave Serial mode. See [Table 7](#) for Mode Select pin settings required for Serial modes. All such pins are in Bank 4 and powered by VCCO\_4.

In both the Master and Slave Serial modes, DIN is the serial configuration data input. The D1-D7 inputs are unused in serial mode and behave like general-purpose I/O pins.

In all the cases, the configuration data is synchronized to the rising edge of the CCLK clock signal.

The DIN, DOUT, and INIT\_B pins can be retained in the application to support reconfiguration by setting the Persist bitstream generation option. However, the serial modes do not support device readback.

Table 3: Dual-Purpose Pins Used in Master or Slave Serial Mode

Pin Name	Direction	Description
DIN	Input	<p><b>Serial Data Input:</b></p> <p>During the Master or Slave Serial configuration modes, DIN is the serial configuration data input, and all data is synchronized to the rising CCLK edge. After configuration, this pin is available as a user I/O.</p> <p>This signal is located in Bank 4 and its output voltage determined by VCCO_4.</p> <p>The BitGen option Persist permits this pin to retain its configuration function in the User mode.</p>
DOUT	Output	<p><b>Serial Data Output:</b></p> <p>In a multi-FPGA design where all the FPGAs use serial mode, connect the DOUT output of one FPGA—in either Master or Slave Serial mode—to the DIN input of the next FPGA—in Slave Serial mode—so that configuration data passes from one to the next, in daisy-chain fashion. This “daisy chain” permits sequential configuration of multiple FPGAs.</p> <p>This signal is located in Bank 4 and its output voltage determined by VCCO_4.</p> <p>The BitGen option Persist permits this pin to retain its configuration function in the User mode.</p>
INIT_B	Bidirectional (open-drain)	<p><b>Initializing Configuration Memory/Configuration Error:</b></p> <p>Just after power is applied, the FPGA produces a Low-to-High transition on this pin indicating that initialization (<i>i.e.</i>, clearing) of the configuration memory has finished. Before entering the User mode, this pin functions as an open-drain output, which requires a pull-up resistor in order to produce a High logic level. In a multi-FPGA design, tie (wire AND) the INIT_B pins from all FPGAs together so that the common node transitions High only after all of the FPGAs have been successfully initialized.</p> <p>Externally holding this pin Low beyond the initialization phase delays the start of configuration. This action stalls the FPGA at the configuration step just before the mode select pins are sampled.</p> <p>During configuration, the FPGA indicates the occurrence of a data (<i>i.e.</i>, CRC) error by asserting INIT_B Low.</p> <p>This signal is located in Bank 4 and its output voltage determined by VCCO_4.</p> <p>The BitGen option Persist permits this pin to retain its configuration function in the User mode.</p>

Configuration Data Byte	I/O Bank 4 (VCCO_4)				I/O Bank 5 (VCCO_5)			
	High Nibble				Low Nibble			
	D0	D1	D2	D3	D4	D5	D6	D7
0xA5 =	1	0	1	0	0	1	0	1

Figure 2: Configuration Data Byte Mapping to D0-D7 Bits

### Parallel Configuration Modes (SelectMAP)

This section describes the dual-purpose configuration pins used during the Master and Slave Parallel configuration modes, sometimes also called the SelectMAP modes. In both Master and Slave Parallel configuration modes, D0-D7 form the byte-wide configuration data input. See Table 7 for Mode Select pin settings required for Parallel modes.

As shown in Figure 2, D0 is the most-significant bit while D7 is the least-significant bit. Bits D0-D3 form the high nibble of the byte and bits D4-D7 form the low nibble.

In the Parallel configuration modes, both the VCCO\_4 and VCCO\_5 voltage supplies are required and must both equal the voltage of the attached configuration device, typically either 2.5V or 3.3V.

Assert Low both the chip-select pin, CS\_B, and the read/write control pin, RDWR\_B, to write the configuration data byte presented on the D0-D7 pins to the FPGA on a rising-edge of the configuration clock, CCLK. The order of

CS\_B and RDWR\_B does not matter, although RDWR\_B must be asserted throughout the configuration process. If RDWR\_B is de-asserted during configuration, the FPGA aborts the configuration operation.

After configuration, these pins are available as general-purpose user I/O. However, the SelectMAP configuration interface is optionally available for debugging and dynamic reconfiguration. To use these SelectMAP pins after configuration, set the Persist bitstream generation option.

The Readback debugging option, for example, requires the Persist bitstream generation option. During Readback mode, assert CS\_B Low, along with RDWR\_B High, to read a configuration data byte from the FPGA to the D0-D7 bus on a rising CCLK edge. During Readback mode, D0-D7 are output pins.

In all the cases, the configuration data and control signals are synchronized to the rising edge of the CCLK clock signal.



Table 4: Dual-Purpose Configuration Pins for Parallel (SelectMAP) Configuration Modes

Pin Name	Direction	Description						
D0, D1, D2, D3	Input during configuration  Output during readback	<p><b>Configuration Data Port (high nibble):</b> Collectively, the D0-D7 pins are the byte-wide configuration data port for the Parallel (SelectMAP) configuration modes. Configuration data is synchronized to the rising edge of CCLK clock signal.</p> <p>The D0-D3 pins are the high nibble of the configuration data byte and located in Bank 4 and powered by VCCO_4.</p> <p>The BitGen option Persist permits this pin to retain its configuration function in the User mode.</p>						
D4, D5, D6, D7	Input during configuration  Output during readback	<p><b>Configuration Data Port (low nibble):</b> The D4-D7 pins are the low nibble of the configuration data byte. However, these signals are located in Bank 5 and powered by VCCO_5.</p> <p>The BitGen option Persist permits this pin to retain its configuration function in the User mode.</p>						
CS_B	Input	<p><b>Chip Select for Parallel Mode Configuration:</b> Assert this pin Low, together with RDWR_B to write a configuration data byte from the D0-D7 bus to the FPGA on a rising CCLK edge.</p> <p>During Readback, assert this pin Low, along with RDWR_B High, to read a configuration data byte from the FPGA to the D0-D7 bus on a rising CCLK edge.</p> <p>This signal is located in Bank 5 and powered by VCCO_5.</p> <p>The BitGen option Persist permits this pin to retain its configuration function in the User mode.</p> <table border="1" data-bbox="435 1024 1453 1150"> <thead> <tr> <th>CS_B</th> <th>Function</th> </tr> </thead> <tbody> <tr> <td>0</td> <td>FPGA selected. SelectMAP inputs are valid on the next rising edge of CCLK.</td> </tr> <tr> <td>1</td> <td>FPGA deselected. All SelectMAP inputs are ignored.</td> </tr> </tbody> </table>	CS_B	Function	0	FPGA selected. SelectMAP inputs are valid on the next rising edge of CCLK.	1	FPGA deselected. All SelectMAP inputs are ignored.
CS_B	Function							
0	FPGA selected. SelectMAP inputs are valid on the next rising edge of CCLK.							
1	FPGA deselected. All SelectMAP inputs are ignored.							

Table 4: Dual-Purpose Configuration Pins for Parallel (SelectMAP) Configuration Modes (Continued)

Pin Name	Direction	Description								
RDWR_B	Input	<p><b>Read/Write Control for Parallel Mode Configuration:</b></p> <p>In Master and Slave Parallel modes, assert this pin Low together with CS_B to write a configuration data byte from the D0-D7 bus to the FPGA on a rising CCLK edge. Once asserted during configuration, RDWR_B must remain asserted until configuration is complete.</p> <p>During Readback, assert this pin High with CS_B Low to read a configuration data byte from the FPGA to the D0-D7 bus on a rising CCLK edge.</p> <p>This signal is located in Bank 5 and powered by VCCO_5.</p> <p>The BitGen option Persist permits this pin to retain its configuration function in the User mode.</p> <table border="1"> <thead> <tr> <th>RDWR_B</th> <th>Function</th> </tr> </thead> <tbody> <tr> <td>0</td> <td>If CS_B is Low, then load (write) configuration data to the FPGA.</td> </tr> <tr> <td>1</td> <td>This option is valid only if the Persist bitstream option is set to Yes. If CS_B is Low, then read configuration data from the FPGA.</td> </tr> </tbody> </table>	RDWR_B	Function	0	If CS_B is Low, then load (write) configuration data to the FPGA.	1	This option is valid only if the Persist bitstream option is set to Yes. If CS_B is Low, then read configuration data from the FPGA.		
RDWR_B	Function									
0	If CS_B is Low, then load (write) configuration data to the FPGA.									
1	This option is valid only if the Persist bitstream option is set to Yes. If CS_B is Low, then read configuration data from the FPGA.									
BUSY	Output	<p><b>Configuration Data Rate Control for Parallel Mode:</b></p> <p>In the Slave and Master Parallel modes, BUSY throttles the rate at which configuration data is loaded. BUSY is only necessary if CCLK operates at greater than 50 MHz. Ignore BUSY for frequencies of 50 MHz and below.</p> <p>When BUSY is Low, the FPGA accepts the next configuration data byte on the next rising CCLK edge for which CS_B and RDWR_B are Low. When BUSY is High, the FPGA ignores the next configuration data byte. The next configuration data value must be held or reloaded until the next rising CCLK edge when BUSY is Low. When CS_B is High, BUSY is in a high impedance state.</p> <table border="1"> <thead> <tr> <th>BUSY</th> <th>Function</th> </tr> </thead> <tbody> <tr> <td>0</td> <td>The FPGA is ready to accept the next configuration data byte.</td> </tr> <tr> <td>1</td> <td>The FPGA is busy processing the current configuration data byte and is not ready to accept the next byte.</td> </tr> <tr> <td>Hi-Z</td> <td>If CS_B is High, then BUSY is high impedance.</td> </tr> </tbody> </table> <p>This signal is located in Bank 4 and its output voltage is determined by VCCO_4. The BitGen option Persist permits this pin to retain its configuration function in the User mode.</p>	BUSY	Function	0	The FPGA is ready to accept the next configuration data byte.	1	The FPGA is busy processing the current configuration data byte and is not ready to accept the next byte.	Hi-Z	If CS_B is High, then BUSY is high impedance.
BUSY	Function									
0	The FPGA is ready to accept the next configuration data byte.									
1	The FPGA is busy processing the current configuration data byte and is not ready to accept the next byte.									
Hi-Z	If CS_B is High, then BUSY is high impedance.									
INIT_B	Bidirectional (open-drain)	<p><b>Initializing Configuration Memory/Configuration Error (active-Low):</b></p> <p>See description under <a href="#">Serial Configuration Modes, page 7</a>.</p>								

### JTAG Configuration Mode

In the JTAG configuration mode all dual-purpose configuration pins are unused and behave exactly like user-I/O pins, as shown in [Table 10](#). See [Table 7](#) for Mode Select pin settings required for JTAG mode.

### Dual-Purpose Pin I/O Standard During Configuration

During configuration, the dual-purpose pins default to CMOS input and output levels for the associated VCCO voltage supply pins. For example, in the Parallel configuration modes, both VCCO\_4 and VCCO\_5 are required. If connected to +2.5V, then the associated pins conform to the

LVC MOS25 I/O standard. If connected to +3.3V, then the pins drive LVC MOS output levels and accept either LV TTL or LVC MOS input levels.

### Dual-Purpose Pin Behavior After Configuration

After the configuration process completes, these pins, if they were borrowed during configuration, become user-I/O pins available to the application. If a dual-purpose configuration pin is not used during the configuration process—*i.e.*, the parallel configuration pins when using serial mode—then the pin behaves exactly like a general-purpose I/O. See [I/O Type: Unrestricted, General-purpose I/O Pins](#) section above.

## DCI: User I/O or Digitally Controlled Impedance Resistor Reference Input

These pins are individual user-I/O pins unless one of the I/O standards used in the bank requires the Digitally Controlled Impedance (DCI) feature. If DCI is used, then 1% precision resistors connected to the VRP\_# and VRN\_# pins match the impedance on the input or output buffers of the I/O standards that use DCI within the bank.

The '#' character in the pin name indicates the associated I/O bank and is an integer, 0 through 7.

There are two DCI pins per I/O bank, except in the TQ144 package, which does not have any DCI inputs for Bank 5.

### VRP and VRN Impedance Resistor Reference Inputs

The 1% precision impedance-matching resistor attached to the VRP\_# pin controls the pull-up impedance of PMOS transistor in the input or output buffer. Consequently, the VRP\_# pin must connect to ground. The 'P' character in "VRP" indicates that this pin controls the I/O buffer's PMOS transistor impedance. The VRP\_# pin is used for both single and split termination.

The 1% precision impedance-matching resistor attached to the VRN\_# pin controls the pull-down impedance of NMOS transistor in the input or output buffer. Consequently, the VRN\_# pin must connect to VCCO. The 'N' character in "VRN" indicates that this pin controls the I/O buffer's NMOS transistor impedance. The VRN\_# pin is only used for split termination.

Each VRN or VRP reference input requires its own resistor. A single resistor cannot be shared between VRN or VRP pins associated with different banks.

During configuration, these pins behave exactly like user-I/O pins. The associated DCI behavior is not active or valid until after configuration completes.

See [“Digitally Controlled Impedance \(DCI\)” under Functional Description \(Module 2 of the Spartan-3 data sheet\)](#).

### DCI Termination Types

If the I/O in an I/O bank do not use the DCI feature, then no external resistors are required and both the VRP\_# and VRN\_# pins are available for user I/O, as shown in [Figure 3a](#).

If the I/O standards within the associated I/O bank require single termination—such as GTL\_DCI, GTLP\_DCI, or HSTL\_III\_DCI—then only the VRP\_# signal connects to a 1% precision impedance-matching resistor, as shown in [Figure 3b](#). The VRN\_# pin is available for user I/O.

Finally, if the I/O standards with the associated I/O bank require split termination—such as HSTL\_I\_DCI, SSTL2\_I\_DCI, SSTL2\_II\_DCI, or LVDS\_25\_DCI and

LVDS\_25\_DCI receivers—then both the VRP\_# and VRN\_# pins connect to separate 1% precision impedance-matching resistors, as shown in [Figure 3c](#). Neither pin is available for user I/O.

## GCLK: Global Clock Buffer Inputs or General-Purpose I/O Pins

These pins are user-I/O pins unless they specifically connect to one of the eight low-skew global clock buffers on the device, specified using the IBUFG primitive.

There are eight GCLK pins per device and two each appear in the top-edge banks, Bank 0 and 1, and the bottom-edge banks, Banks 4 and 5. See [Figure 1](#) for a picture of bank labeling.

During configuration, these pins behave exactly like user-I/O pins.

## CONFIG: Dedicated Configuration Pins

The dedicated configuration pins control the configuration process and are not available as user-I/O pins. Every package has seven dedicated configuration pins. All CONFIG-type pins are powered by the +2.5V VCCAUX supply.

See [“Configuration” under Functional Description \(Module 2 of the Spartan-3 data sheet\)](#).

### CCLK: Configuration Clock

The configuration clock signal on this pin synchronizes the reading or writing of configuration data. This pin is an input for the Slave configuration modes, both parallel and serial.

After configuration, the CCLK pin is in a high-impedance, floating state. By default, CCLK optionally is pulled High to VCCAUX as defined by the CclkPin bitstream selection. Any clocks applied to CCLK after configuration are ignored unless the bitstream option Persist is set to Yes, which retains the configuration interface. Persist is set to No by default. However, if Persist is set to Yes, then all clock edges are potentially active events, depending on the other configuration control signals.

The bitstream generator option ConfigRate determines the frequency of the internally-generated CCLK oscillator required for the Master configuration modes. The actual frequency is approximate due to the characteristics of the silicon oscillator and varies by up to 30% over the temperature and voltage range. By default, CCLK operates at approximately 6 MHz. Via the ConfigRate option, the oscillator frequency is set at approximately 3, 6, 12, 25, or 50 MHz. At power-on, CCLK always starts operation at its lowest frequency. The device does not start operating at the higher frequency until the ConfigRate control bits are loaded during the configuration process.

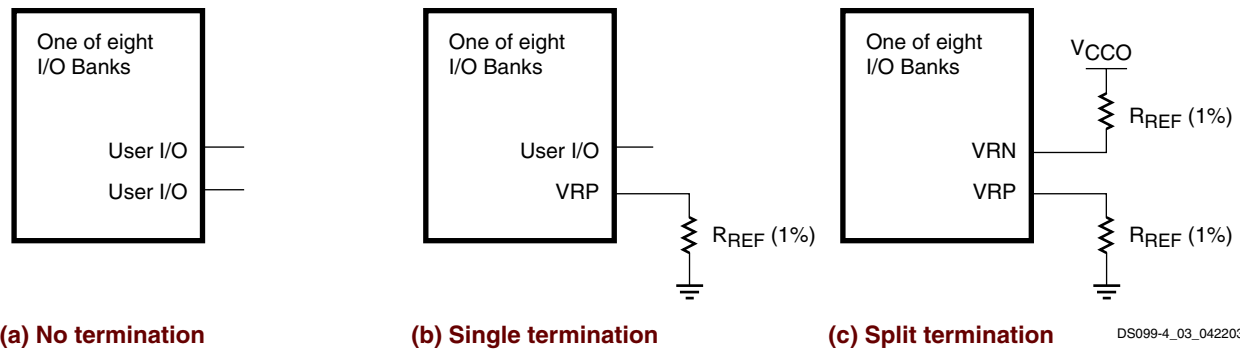



Figure 3: DCI Termination Types

### PROG\_B: Program/Configure Device

This asynchronous pin initiates the configuration or re-configuration processes. A Low-going pulse resets the configuration logic, initializing the configuration memory. This initialization process cannot finish until PROG\_B returns High. Asserting PROG\_B Low for an extended period delays the configuration process. At power-up, there is always a weak pull-up resistor to VCCAUX on this pin. After configuration, the bitstream generator option ProgPin determines whether or not the weak pull-up resistor is present. By default, the ProgPin option retains the weak pull-up resistor.

After configuration, hold the PROG\_B input High. Any Low-going pulse on PROG\_B restarts the configuration process.

Table 5: PROG\_B Operation

PROG_B Input	Response
<b>Power-up</b>	Automatically initiates configuration process.
<b>Low-going pulse</b> 	Initiate (re-)configuration process and continue to completion.
<b>Extended Low</b> 	Initiate (re-)configuration process and stall process at step where configuration memory is cleared. Process is stalled until PROG_B returns High.
<b>1</b>	If the configuration process is started, continue to completion. If configuration process is complete, stay in User mode.

### DONE: Configuration Done, Delay Start-Up Sequence

The FPGA produces a Low-to-High transition on this pin indicating that the configuration process is complete. The bitstream generator option DriveDone determines whether this pin functions as a totem-pole output that can drive High or as an open-drain output. If configured as an open-drain output—which is the default behavior—then a pull-up resistor is required to produce a High logic level. There is a bitstream option that provides an internal weak pull-up resistor, otherwise an external pull-up resistor is required.

The open-drain option permits the DONE lines of multiple FPGAs to be tied together, so that the common node transitions High only after all of the FPGAs have completed configuration. Externally holding the open-drain DONE pin Low delays the start-up sequence, which marks the transition to user mode.

Once the FPGA enters User mode after completing configuration, the DONE pin no longer drives the DONE pin Low. The bitstream generator option DonePin determines whether or not a weak pull-up resistor is present on the DONE pin to pull the pin to VCCAUX. If the weak pull-up resistor is eliminated, then the DONE pin must be pulled High using an external pull-up resistor or one of the FPGAs in the design must actively drive the DONE pin High via the DriveDone bitstream generator option.

The bitstream generator option DriveDone causes the FPGA to actively drive the DONE output High after configuration. This option should only be used in single-FPGA designs or on the last FPGA in a multi-FPGA daisy-chain.

By default, the bitstream generator software retains the weak pull-up resistor and does not actively drive the DONE pin as highlighted in Table 6. Table 6 shows the interaction of these bitstream options in single- and multi-FPGA designs.

Table 6: DonePin and DriveDone Bitstream Option Interaction

DonePin	DriveDone	Single- or Multi-FPGA Design	Comments
Pullnone	No	Single	External pull-up resistor, with value between 330Ω to 3.3kΩ required on DONE.
Pullnone	No	Multi	External pull-up resistor, with value between 330Ω to 3.3kΩ required on common node connecting to all DONE pins.
Pullnone	Yes	Single	OK, no external requirements.
Pullnone	Yes	Multi	DriveDone on last device in daisy-chain only. No external requirements.
Pullup	No	Single	OK, but weak pull-up on DONE pin has slow rise time. May require 330 Ω pull-up resistor for high CCLK frequencies.
Pullup	No	Multi	External pull-up resistor, with value between 330Ω to 3.3kΩ required on common node connecting to all DONE pins.
Pullup	Yes	Single	OK, no external requirements.
Pullup	Yes	Multi	DriveDone on last device in daisy-chain only. No external requirements.

**M2, M1, M0: Configuration Mode Selection**

These inputs select the mode to configure the FPGA. The logic levels applied to the mode pins are sampled on the rising edge of INIT\_B.

Table 7: Spartan-3 Configuration Mode Select Settings

Configuration Mode	M2	M1	M0
Master Serial	0	0	0
Slave Serial	1	1	1
Master Parallel	0	1	1
Slave Parallel	1	1	0
JTAG	1	0	1
Reserved	0	0	1
Reserved	0	1	0
Reserved	1	0	0
After Configuration	X	X	X

**Notes:**

- 1. X = don't care, either 0 or 1.

In user mode, after configuration successfully completes, any levels applied to these input are ignored. Each of the bitstream generator options M0Pin, M1Pin, and M2Pin determines whether a weak pull-up resistor, weak pull-down resistor, or no resistor is present on its respective mode pin, M0, M1, or M2.

**HSWAP\_EN: Disable Weak Pull-up Resistors During Configuration**

A Low on this asynchronous pin enables weak pull-up resistors on all user I/Os, although only until device configuration

completes. A High disables the weak pull-up resistors (during configuration, which is the desired state for some applications).

Table 8: HSWAP\_EN Encoding

HSWAP_EN	Function
<b>During Configuration</b>	
0	Enable weak pull-up resistors on all pins not actively involved in the configuration process. Pull-ups are only active until configuration completes. See Table 10.
1	No pull-up resistors during configuration.
<b>After Configuration, User Mode</b>	
X	This pin has no function except during device configuration.

**Notes:**

- 1. X = don't care, either 0 or 1.

After configuration, HSWAP\_EN essentially becomes a "don't care" input and any pull-up resistors previously enabled by HSWAP\_EN are disabled. If a user I/O in the application requires a weak pull-up resistor after configuration, place a PULLUP primitive on the associated I/O pin.

The Bitstream generator option HswapenPin determines whether a weak pull-up resistor to VCCAUX, a weak pull-down resistor, or no resistor is present on HSWAP\_EN after configuration.

**JTAG: Dedicated JTAG Port Pins**

These pins are dedicated connections to the four-wire IEEE 1532/IEEE 1149.1 JTAG port, shown in Figure 4 and

described in [Table 9](#). The JTAG port is used for boundary-scan testing, device configuration, application debugging, and possibly an additional serial port for the application. These pins are dedicated and are not available as user-I/O pins. Every package has four dedicated JTAG pins and these pins are powered by the +2.5V VCCAUX supply.

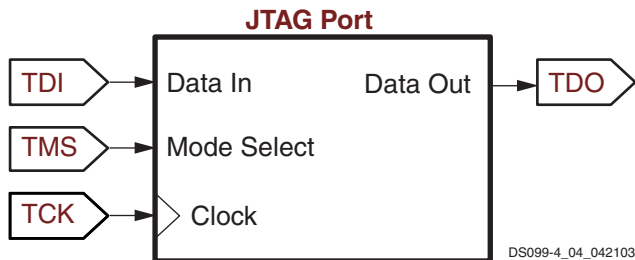

Figure 4: JTAG Port

### Using JTAG Port After Configuration

The JTAG port is always active and available before and after FPGA configuration. However, to create user-defined JTAG instructions and internal JTAG chains, add the BSCAN\_SPARTAN3 primitive to the design.

Furthermore, the contents of the User ID register within the JTAG port can be specified as a Bitstream Generation option. By default, the 32-bit User ID register contains 0xFFFFFFFF.

### Precautions When Using the JTAG Port in 3.3V Environments

The JTAG port is powered by the +2.5V VCCAUX power supply. When connecting to a 3.3V interface, the JTAG input pins must be current-limited to 10 mA or less using a series

resistor. Similarly, the TDO pin is a CMOS output powered from +2.5V. The TDO output can directly drive a 3.3V input but with reduced noise immunity. See the "3.3V-Tolerant Configuration Interface" section in [Module 2](#) for additional details.

The following interface precautions are recommended when connecting the JTAG port to a 3.3V interface.

1. Set any inactive JTAG signals, including TCK, Low when not actively used.
2. Limit the drive current into a JTAG input to no more than 10 mA.

### VREF: User I/O or Input Buffer Reference Voltage for Special Interface Standards

These pins are individual user-I/O pins unless collectively they supply an input reference voltage, VREF\_#, for any SSTL, HSTL, GTL, or GTLP I/Os implemented in the associated I/O bank.

The '#' character in the pin name represents an integer, 0 through 7, that indicates the associated I/O bank.

The VREF function becomes active for this pin whenever a signal standard requiring a reference voltage is used in the associated bank.

If used as a user I/O, then each pin behaves as an independent I/O described in the I/O type section. If used for a reference voltage within a bank, then *all* VREF pins within the bank must be connected to the same reference voltage.

Spartan-3 devices are designed and characterized to support certain I/O standards when VREF is connected to +1.25V, +1.10V, +1.00V, +0.90V, +0.80V, and +0.75V.

During configuration, these pins behave exactly like user-I/O pins.

Table 9: JTAG Pin Descriptions

Pin Name	Direction	Description	Bitstream Generation Option
TCK	Input	<b>Test Clock:</b> The TCK clock signal synchronizes all boundary scan operations on its rising edge.	The BitGen option <b>TckPin</b> determines whether a weak pull-up resistor, weak pull-down resistor or no resistor is present.
TDI	Input	<b>Test Data Input:</b> TDI is the serial data input for all JTAG instruction and data registers. This input is sampled on the rising edge of TCK.	The BitGen option <b>TdiPin</b> determines whether a weak pull-up resistor, weak pull-down resistor or no resistor is present.
TMS	Input	<b>Test Mode Select:</b> The TMS input controls the sequence of states through which the JTAG TAP state machine passes. This input is sampled on the rising edge of TCK.	The BitGen option <b>TmsPin</b> determines whether a weak pull-up resistor, weak pull-down resistor or no resistor is present.
TDO	Output	<b>Test Data Output:</b> The TDO pin is the data output for all JTAG instruction and data registers. This output is sampled on the rising edge of TCK. The TDO output is an active totem-pole driver and is not like the open-collector TDO output on Virtex-II Pro™ FPGAs.	The BitGen option <b>TdoPin</b> determines whether a weak pull-up resistor, weak pull-down resistor or no resistor is present.

If designing for footprint compatibility across the range of devices in a specific package, and if the VREF\_# pins within a bank connect to an input reference voltage, then also connect any N.C. (not connected) pins on the smaller devices in that package to the input reference voltage. More details are provided later for each package type.

### N.C. Type: Unconnected Package Pins

Pins marked as “N.C.” are unconnected for the specific device/package combination. For other devices in this same package, this pin may be used as an I/O or VREF connection. In both the pinout tables and the footprint diagrams, unconnected pins are noted with either a black diamond symbol (◆) or a black square symbol (■).

If designing for footprint compatibility across multiple device densities, check the pin types of the other Spartan-3 devices available in the same footprint. If the N.C. pin matches to VREF pins in other devices, and the VREF pins are used in the associated I/O bank, then connect the N.C. to the VREF voltage source.

### VCCO Type: Output Voltage Supply for I/O Bank

Each I/O bank has its own set of voltage supply pins that determines the output voltage for the output buffers in the I/O bank. Furthermore, for some I/O standards such as LVCMOS, LVCMOS25, LVTTTL, etc., VCCO sets the input threshold voltage on the associated input buffers.

Spartan-3 devices are designed and characterized to support various I/O standards for VCCO values of +1.2V, +1.5V, +1.8V, +2.5V, and +3.3V.

Most VCCO pins are labeled as VCCO\_# where the ‘#’ symbol represents the associated I/O bank number, an integer ranging from 0 to 7. In the 144-pin TQFP package (TQ144) however, the VCCO pins along an edge of the device are combined into a single VCCO input. For example, the VCCO inputs for Bank 0 and Bank 1 along the top edge of the package are combined and relabeled VCCO\_TOP. The bottom, left, and right edges are similarly combined.

In Serial configuration mode, VCCO\_4 must be at a level compatible with the attached configuration memory or data source. In Parallel configuration mode, both VCCO\_4 and VCCO\_5 must be at the same compatible voltage level.

All VCCO inputs to a bank must be connected together and to the voltage supply. Furthermore, there must be sufficient supply decoupling to guarantee problem-free operation, as described in [XAPP623: Power Distribution System \(PDS\) Design: Using Bypass/Decoupling Capacitors](#).

### VCCINT Type: Voltage Supply for Internal Core Logic

Internal core logic circuits such as the configurable logic blocks (CLBs) and programmable interconnect operate

from the VCCINT voltage supply inputs. VCCINT must be +1.2V.

All VCCINT inputs must be connected together and to the +1.2V voltage supply. Furthermore, there must be sufficient supply decoupling to guarantee problem-free operation, as described in [XAPP623: Power Distribution System \(PDS\) Design: Using Bypass/Decoupling Capacitors](#).

### VCCAUX Type: Voltage Supply for Auxiliary Logic

The VCCAUX pins supply power to various auxiliary circuits, such as to the Digital Clock Managers (DCMs), the JTAG pins, and to the dedicated configuration pins (CONFIG type). VCCAUX must be +2.5V.

All VCCAUX inputs must be connected together and to the +2.5V voltage supply. Furthermore, there must be sufficient supply decoupling to guarantee problem-free operation, as described in [XAPP623: Power Distribution System \(PDS\) Design: Using Bypass/Decoupling Capacitors](#).

Because VCCAUX connects to the DCMs and the DCMs are sensitive to voltage changes, be sure that the VCCAUX supply and the ground return paths are designed for low noise and low voltage drop, especially that caused by a large number of simultaneous switching I/Os.

### GND Type: Ground

All GND pins must be connected and have a low resistance path back to the various VCCO, VCCINT, and VCCAUX supplies.

### Pin Behavior During Configuration

**Table 10** shows how various pins behave during the FPGA configuration process. The actual behavior depends on the values applied to the M2, M1, and M0 mode select pins and the HSWAP\_EN pin. The mode select pins determine which of the DUAL type pins are active during configuration. In JTAG configuration mode, none of the DUAL-type pins are used for configuration and all behave as user-I/O pins.

All DUAL-type pins not actively used during configuration and all I/O-type, DCI-type, VREF-type, GCLK-type pins are high impedance (floating, three-stated, Hi-Z) during the configuration process. These pins are indicated in **Table 10** as shaded table entries or cells. These pins have a weak pull-up resistor to their associated VCCO if the HSWAP\_EN pin is Low.

After configuration completes, some pins have optional behavior controlled by the configuration bitstream loaded into the part. For example, via the bitstream, all unused I/O pins can collectively be configured to have a weak pull-up resistor, a weak pull-down resistor, or be left in a high-impedance state.

Table 10: Pin Behavior After Power-Up, During Configuration

Pin Name	Configuration Mode Settings <M2:M1:M0>					Bitstream Configuration Option
	Serial Modes		SelectMap Parallel Modes		JTAG Mode <1:0:1>	
	Master <0:0:0>	Slave <1:1:1>	Master <0:1:1>	Slave <1:1:0>		
<b>I/O:</b> General-purpose I/O pins						
IO						UnusedPin
IO_Lxxy_#						UnusedPin
<b>DUAL:</b> Dual-purpose configuration pins						
IO_Lxxy_#/DIN/D0	DIN (I)	DIN (I)	D0 (I/O)	D0 (I/O)		Persist UnusedPin
IO_Lxxy_#/D1			D1 (I/O)	D1 (I/O)		Persist UnusedPin
IO_Lxxy_#/D2			D2 (I/O)	D2 (I/O)		Persist UnusedPin
IO_Lxxy_#/D3			D3 (I/O)	D3 (I/O)		Persist UnusedPin
IO_Lxxy_#/D4			D4 (I/O)	D4 (I/O)		Persist UnusedPin
IO_Lxxy_#/D5			D5 (I/O)	D5 (I/O)		Persist UnusedPin
IO_Lxxy_#/D6			D6 (I/O)	D6 (I/O)		Persist UnusedPin
IO_Lxxy_#/D7			D7 (I/O)	D7 (I/O)		Persist UnusedPin
IO_Lxxy_#/CS_B			CS_B (I)	CS_B (I)		Persist UnusedPin
IO_Lxxy_#/RDWR_B			RDWR_B (I)	RDWR_B (I)		Persist UnusedPin
IO_Lxxy_#/BUSY/DOUT	DOUT (O)	DOUT (O)	BUSY (O)	BUSY (O)		Persist UnusedPin
IO_Lxxy_#/INIT_B	INIT_B (I/OD)	INIT_B (I/OD)	INIT_B (I/OD)	INIT_B (I/OD)		UnusedPin
<b>DCI:</b> Digitally Controlled Impedance reference resistor input pins						
IO_Lxxy_#/VRN_#						UnusedPin
IO/VRN_#						UnusedPin
IO_Lxxy_#/VRP_#						UnusedPin
IO/VRP_#						UnusedPin



Table 10: Pin Behavior After Power-Up, During Configuration (Continued)



Pin Name	Configuration Mode Settings <M2:M1:M0>					Bitstream Configuration Option
	Serial Modes		SelectMap Parallel Modes		JTAG Mode <1:0:1>	
	Master <0:0:0>	Slave <1:1:1>	Master <0:1:1>	Slave <1:1:0>		
<b>GCLK:</b> Global clock buffer inputs						
IO_Lxxy_#/GCLK0 through GCLK7						UnusedPin
<b>VREF:</b> I/O bank input reference voltage pins						
IO_Lxxy_#/VREF_#						UnusedPin
IO/VREF_#						UnusedPin
<b>CONFIG:</b> Dedicated configuration pins						
CCLK	CCLK (O)	CCLK (I)	CCLK (O)	CCLK (I)		CclkPin ConfigRate
PROG_B	PROG_B (I) (pull-up)	PROG_B (I) (pull-up)	PROG_B (I) (pull-up)	PROG_B (I) (pull-up)	PROG_B (I), Via JPROG_B instruction	ProgPin
DONE	DONE (I/OD)	DONE (I/OD)	DONE (I/OD)	DONE (I/OD)	DONE (I/OD)	DriveDone DonePin DonePipe
M2	M2=0 (I)	M2=1 (I)	M2=0 (I)	M2=1 (I)	M2=1 (I)	M2Pin
M1	M1=0 (I)	M1=1 (I)	M1=1 (I)	M1=1 (I)	M1=0 (I)	M1Pin
M0	M0=0 (I)	M0=1 (I)	M0=1 (I)	M0=0 (I)	M0=1 (I)	M0Pin
HSWAP_EN	HSWAP_EN (I)	HSWAP_EN (I)	HSWAP_EN (I)	HSWAP_EN (I)	HSWAP_EN (I)	HswapenPin
<b>JTAG:</b> JTAG interface pins						
TDI	TDI (I)	TDI (I)	TDI (I)	TDI (I)	TDI (I)	TdiPin
TMS	TMS (I)	TMS (I)	TMS (I)	TMS (I)	TMS (I)	TmsPin
TCK	TCK (I)	TCK (I)	TCK (I)	TCK (I)	TCK (I)	TckPin
TDO	TDO (O)	TDO (O)	TDO (O)	TDO (O)	TDO (O)	TdoPin
<b>VCCO:</b> I/O bank output voltage supply pins						
VCCO_4 (for DUAL pins)	Same voltage as external interface	Same voltage as external interface	Same voltage as external interface	Same voltage as external interface	VCCO_4	
VCCO_5 (for DUAL pins)	VCCO_5	VCCO_5	Same voltage as external interface	Same voltage as external interface	VCCO_5	
VCCO_#	VCCO_#	VCCO_#	VCCO_#	VCCO_#	VCCO_#	
<b>VCCAUX:</b> Auxiliary voltage supply pins						
VCCAUX	+2.5V	+2.5V	+2.5V	+2.5V	+2.5V	

Table 10: Pin Behavior After Power-Up, During Configuration (Continued)

Pin Name	Configuration Mode Settings <M2:M1:M0>					JTAG Mode <1:0:1>	Bitstream Configuration Option
	Serial Modes		SelectMap Parallel Modes				
	Master <0:0:0>	Slave <1:1:1>	Master <0:1:1>	Slave <1:1:0>			
<b>VCCINT: Internal core voltage supply pins</b>							
VCCINT	+1.2V	+1.2V	+1.2V	+1.2V	+1.2V		
<b>GND: Ground supply pins</b>							
GND	GND	GND	GND	GND	GND		

**Notes:**

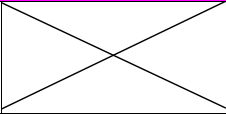
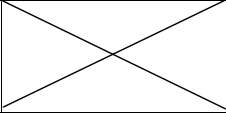
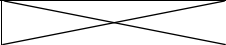
1. # = I/O bank number, an integer from 0 to 7.
2. (I) = input, (O) = output, (OD) = open-drain output, (I/O) = bidirectional, (I/OD) = bidirectional with open-drain output. Open-drain output requires pull-up to create logic High level.
3.  Shaded cell indicates that the pin is high-impedance during configuration. To enable a soft pull-up resistor during configuration, drive or tie HSWAP\_EN Low.

## Bitstream Options

Table 11 lists the various bitstream options that affect pins on a Spartan-3 FPGA. The table shows the names of the affected pins, describes the function of the bitstream option,

the name of the bitstream generator option variable, and the legal values for each variable. The default option setting for each variable is indicated with bold, underlined text.

Table 11: Bitstream Options Affecting Spartan-3 Pins

Affected Pin Name(s)	Bitstream Generation Function	Option Variable Name	Values (default value)
All unused I/O pins of type I/O, DUAL, GCLK, DCI, VREF	For all I/O pins that are unused after configuration, this option defines whether the I/Os are individually tied to VCCO via a weak pull-up resistor, tied ground via a weak pull-down resistor, or left floating. If left floating, the unused pins should be connected to a defined logic level, either from a source internal to the FPGA or external.	UnusedPin	<ul style="list-style-type: none"> <li>• <b><u>Pulldown</u></b></li> <li>• Pullup</li> <li>• Pullnone</li> </ul>
IO_Lxxy_#/DIN, IO_Lxxy_#/DOUT, IO_Lxxy_#/INIT_B	Serial configuration mode: If set to Yes, then these pins retain their functionality after configuration completes, allowing for device (re-)configuration. Readback is not supported in with serial mode.	Persist	<ul style="list-style-type: none"> <li>• <b><u>No</u></b></li> <li>• Yes</li> </ul>
IO_Lxxy_#/D0, IO_Lxxy_#/D1, IO_Lxxy_#/D2, IO_Lxxy_#/D3, IO_Lxxy_#/D4, IO_Lxxy_#/D5, IO_Lxxy_#/D6, IO_Lxxy_#/D7, IO_Lxxy_#/CS_B, IO_Lxxy_#/RDWR_B, IO_Lxxy_#/BUSY, IO_Lxxy_#/INIT_B	Parallel configuration mode (also called SelectMAP): If set to Yes, then these pins retain their SelectMAP functionality after configuration completes, allowing for device readback and for partial or complete (re-)configuration.	Persist	<ul style="list-style-type: none"> <li>• <b><u>No</u></b></li> <li>• Yes</li> </ul>
CCLK	After configuration, this bitstream option either pulls CCLK to VCCAUX via a weak pull-up resistor, or allows CCLK to float.	CclkPin	<ul style="list-style-type: none"> <li>• <b><u>Pullup</u></b></li> <li>• Pullnone</li> </ul>
CCLK	For Master configuration modes, this option sets the approximate frequency, in MHz, for the internal silicon oscillator.	ConfigRate	3, <b><u>6</u></b> , 12, 25, 50

Table 11: Bitstream Options Affecting Spartan-3 Pins (Continued)

Affected Pin Name(s)	Bitstream Generation Function	Option Variable Name	Values (default value)
PROG_B	A weak pull-up resistor to VCCAUX exists on PROG_B during configuration. After configuration, this bitstream option either pulls DONE to VCCAUX via a weak pull-up resistor, or allows DONE to float.	ProgPin	<ul style="list-style-type: none"> <li>• <b>Pullup</b></li> <li>• Pullnone</li> </ul>
DONE	After configuration, this bitstream option either pulls DONE to VCCAUX via a weak pull-up resistor, or allows DONE to float. See also DriveDone option.	DonePin	<ul style="list-style-type: none"> <li>• <b>Pullup</b></li> <li>• Pullnone</li> </ul>
DONE	If set to Yes, this option allows the FPGA's DONE pin to drive High when configuration completes. By default, the DONE is an open-drain output and can only drive Low. Only single FPGAs and the last FPGA in a multi-FPGA daisy-chain should use this option.	DriveDone	<ul style="list-style-type: none"> <li>• <b>No</b></li> <li>• Yes</li> </ul>
M2	After configuration, this bitstream option either pulls M2 to VCCAUX via a weak pull-up resistor, to ground via a weak pull-down resistor, or allows M2 to float.	M2Pin	<ul style="list-style-type: none"> <li>• <b>Pullup</b></li> <li>• Pulldown</li> <li>• Pullnone</li> </ul>
M1	After configuration, this bitstream option either pulls M1 to VCCAUX via a weak pull-up resistor, to ground via a weak pull-down resistor, or allows M1 to float.	M1Pin	<ul style="list-style-type: none"> <li>• <b>Pullup</b></li> <li>• Pulldown</li> <li>• Pullnone</li> </ul>
M0	After configuration, this bitstream option either pulls M0 to VCCAUX via a weak pull-up resistor, to ground via a weak pull-down resistor, or allows M0 to float.	M0Pin	<ul style="list-style-type: none"> <li>• <b>Pullup</b></li> <li>• Pulldown</li> <li>• Pullnone</li> </ul>
HSWAP_EN	After configuration, this bitstream option either pulls HSWAP_EN to VCCAUX via a weak pull-up resistor, to ground via a weak pull-down resistor, or allows HSWAP_EN to float.	HswapenPin	<ul style="list-style-type: none"> <li>• <b>Pullup</b></li> <li>• Pulldown</li> <li>• Pullnone</li> </ul>
TDI	After configuration, this bitstream option either pulls TDI to VCCAUX via a weak pull-up resistor, to ground via a weak pull-down resistor, or allows TDI to float.	TdiPin	<ul style="list-style-type: none"> <li>• <b>Pullup</b></li> <li>• Pulldown</li> <li>• Pullnone</li> </ul>
TMS	After configuration, this bitstream option either pulls TMS to VCCAUX via a weak pull-up resistor, to ground via a weak pull-down resistor, or allows TMS to float.	TmsPin	<ul style="list-style-type: none"> <li>• <b>Pullup</b></li> <li>• Pulldown</li> <li>• Pullnone</li> </ul>
TCK	After configuration, this bitstream option either pulls TCK to VCCAUX via a weak pull-up resistor, to ground via a weak pull-down resistor, or allows TCK to float.	TckPin	<ul style="list-style-type: none"> <li>• <b>Pullup</b></li> <li>• Pulldown</li> <li>• Pullnone</li> </ul>
TDO	After configuration, this bitstream option either pulls TDO to VCCAUX via a weak pull-up resistor, to ground via a weak pull-down resistor, or allows TDO to float.	TdoPin	<ul style="list-style-type: none"> <li>• <b>Pullup</b></li> <li>• Pulldown</li> <li>• Pullnone</li> </ul>

## Setting Options via BitGen Command-Line Program

To set one or more bitstream generator options using the BitGen command-line program, enter

```
bitgen -g <variable_name>:<value>
[<variable_name>:<value> ...]
```

where **<variable\_name>** is one of the entries from [Table 11](#) and **<value>** is one of the possible values for the specified variable. Multiple bitstream options may be entered in this manner.

For a complete listing of all BitGen options, their possible settings, and their default settings, enter the following command.

```
bitgen -help spartan3
```

## Setting Options in Project Navigator

To set the bitstream generation options in Xilinx ISE Project Navigator, right-click on the **Generate Programming File** step in the Process View and click **Properties**, as shown in Figure 5.

Click the **Configuration options** tab and modify the available options as required by the application, as shown in Figure 6.

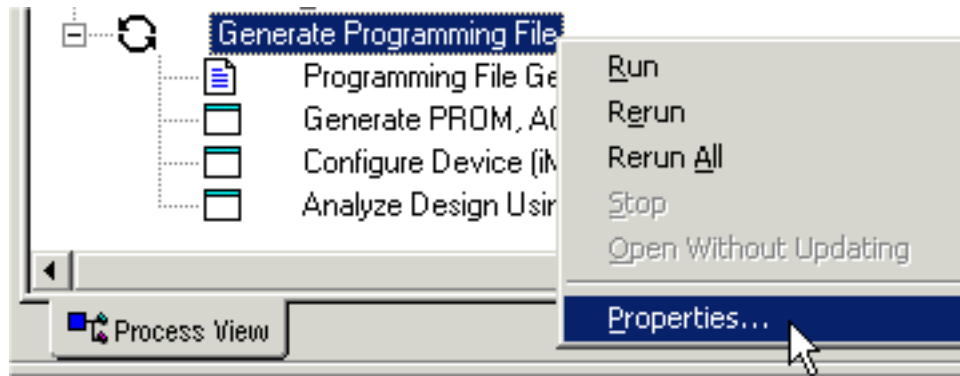

DS099-4\_05\_030103

Figure 5: Setting Properties for Generate Programming File Step

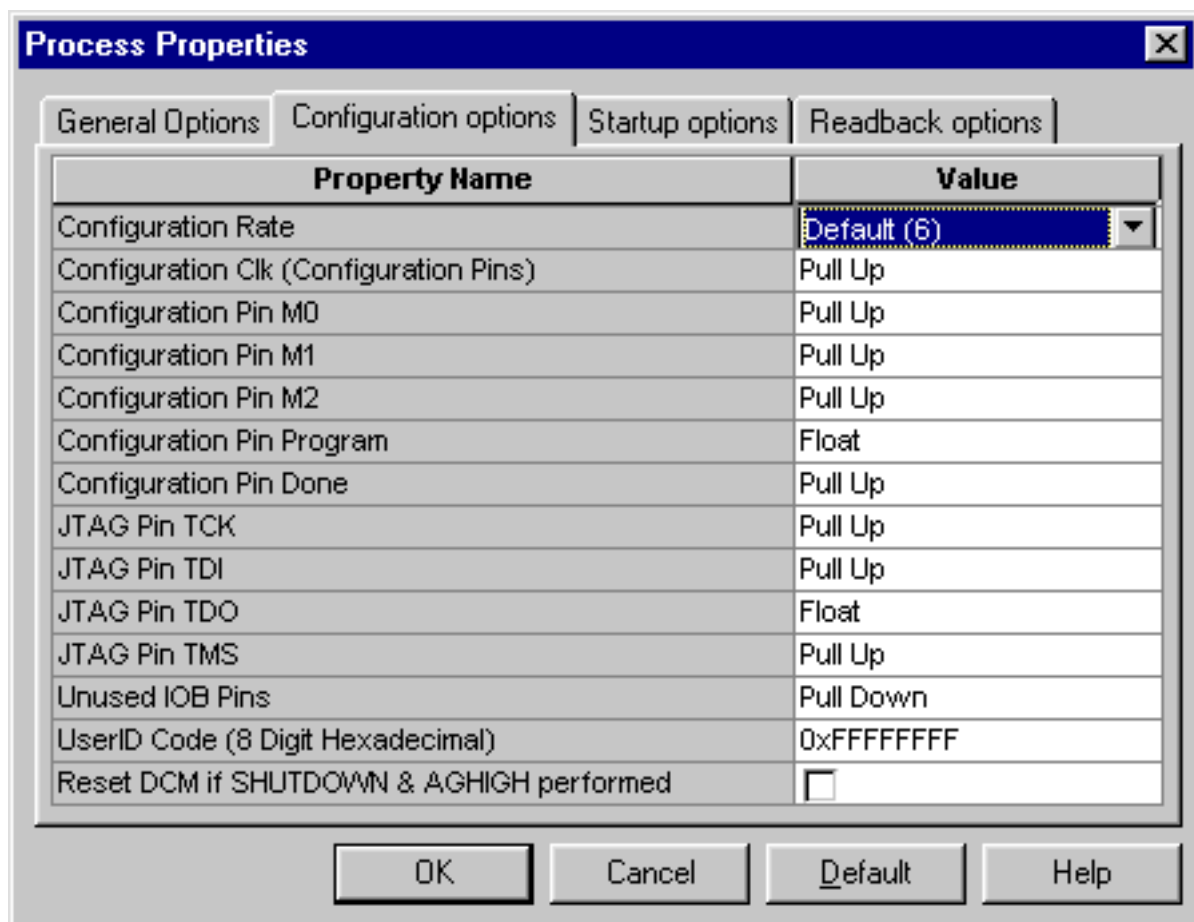

DS099-4\_06\_030103

Figure 6: Configuration Option Settings

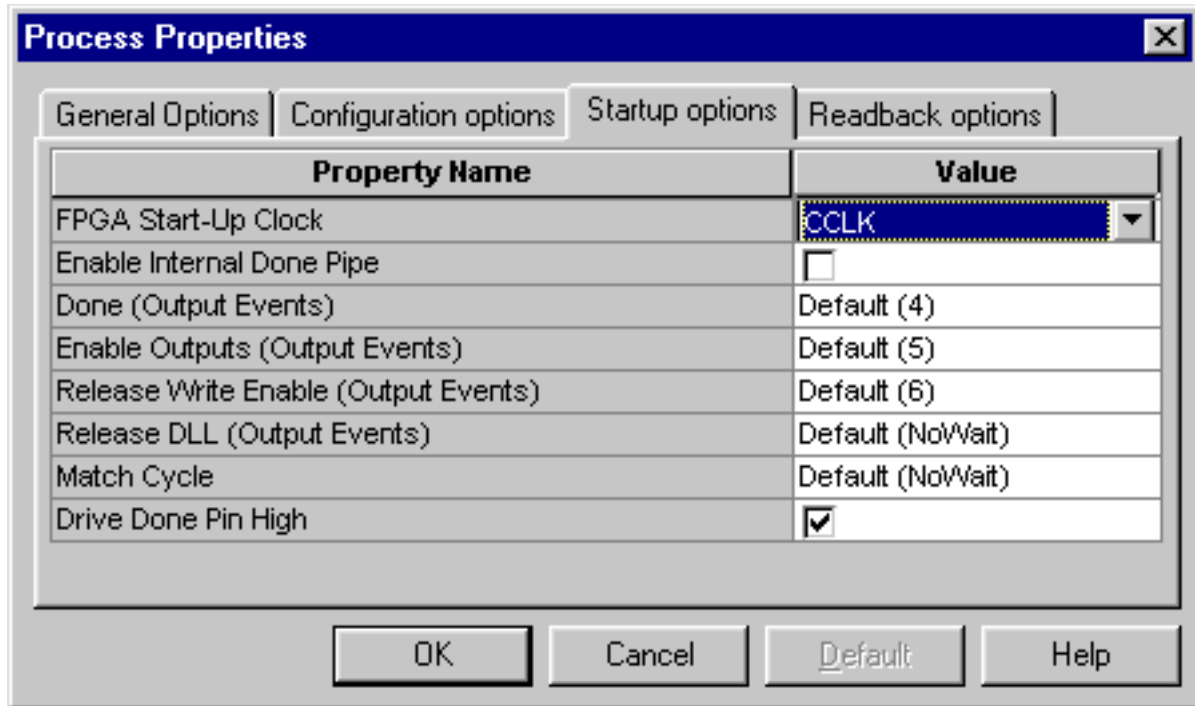

DS099-4\_07\_030103

Figure 7: Setting to Drive DONE Pin High after Configuration

To have the DONE pin drive High after successful configuration, click the **Startup options** tab and check the **Drive Done Pin High** box, as shown in Figure 7.

Click **OK** when finished.

Again, right-click on the **Generate Programming File** step in the Process View. This time, choose **Run** or **Rerun** to execute the changes.

## Package Overview

Table 12 shows the nine low-cost, space-saving production packages for the Spartan-3 family. Not all Spartan-3 densities are available in all packages. However, for a specific package there is a common footprint for that supports the various devices available in that package. See the footprint diagrams that follow.

Table 12: Spartan-3 Family Package Options

Package	Leads	Type	Maximum I/O	Pitch (mm)	Area (mm)	Height (mm)
VQ100	100	Very-thin Quad Flat Pack	63	0.5	16 x 16	1.20
TQ144	144	Thin Quad Flat Pack	97	0.5	22 x 22	1.60
PQ208	208	Quad Flat Pack	141	0.5	30.6 x 30.6	4.10
FT256	256	Fine-pitch, Thin Ball Grid Array	173	1.0	17 x 17	1.55
FG320	320	Fine-pitch Ball Grid Array	221	1.0	19 x 19	2.00
FG456	456	Fine-pitch Ball Grid Array	333	1.0	23 x 23	2.60
FG676	676	Fine-pitch Ball Grid Array	489	1.0	27 x 27	2.60
FG900	900	Fine-pitch Ball Grid Array	633	1.0	31 x 31	2.60
FG1156	1156	Fine-pitch Ball Grid Array	784	1.0	35 x 35	2.60

Detailed mechanical drawings for each package type are available from the Xilinx website at the specified location in [Table 13](#).

**Table 13: Xilinx Package Mechanical Drawings**

Package	Web Link (URL)
VQ100	<a href="http://www.xilinx.com/bvdocs/packages/vq100.pdf">http://www.xilinx.com/bvdocs/packages/vq100.pdf</a>
TQ144	<a href="http://www.xilinx.com/bvdocs/packages/tq144.pdf">http://www.xilinx.com/bvdocs/packages/tq144.pdf</a>
PQ208	<a href="http://www.xilinx.com/bvdocs/packages/pq208.pdf">http://www.xilinx.com/bvdocs/packages/pq208.pdf</a>
FT256	<a href="http://www.xilinx.com/bvdocs/packages/ft256.pdf">http://www.xilinx.com/bvdocs/packages/ft256.pdf</a>
FG320	<a href="http://www.xilinx.com/bvdocs/packages/fg320.pdf">http://www.xilinx.com/bvdocs/packages/fg320.pdf</a>
FG456	<a href="http://www.xilinx.com/bvdocs/packages/fg456.pdf">http://www.xilinx.com/bvdocs/packages/fg456.pdf</a>
FG676	<a href="http://www.xilinx.com/bvdocs/packages/fg676.pdf">http://www.xilinx.com/bvdocs/packages/fg676.pdf</a>
FG900	<a href="http://www.xilinx.com/bvdocs/packages/fg900.pdf">http://www.xilinx.com/bvdocs/packages/fg900.pdf</a>
FG1156	<a href="http://www.xilinx.com/bvdocs/packages/fg1156.pdf">http://www.xilinx.com/bvdocs/packages/fg1156.pdf</a>

Each package has three separate voltage supply inputs—VCCINT, VCCAUX, and VCCO—and a common ground return, GND. The numbers of pins dedicated to these functions varies by package, as shown in [Table 14](#).

**Table 14: Power and Ground Supply Pins by Package**

Package	VCCINT	VCCAUX	VCCO	GND
VQ100	4	4	8	10
TQ144	4	4	12	16
PQ208	4	8	12	28
FT256	8	8	24	32
FG320	12	8	28	40
FG456	12	8	40	52
FG676	20	16	64	76
FG900	32	24	80	120
FG1156	40	32	104	184

A majority of package pins are user-defined I/O pins. However, the numbers and characteristics of these I/O depends on the device type and the package in which it is available, as shown in [Table 15](#). The table shows the maximum number of single-ended I/O pins available, assuming that all I/O-, DUAL-, DCI-, VREF-, and GCLK-type pins are used as general-purpose I/O. Likewise, the table shows the maximum number of differential pin-pairs available on the package. Finally, the table shows how the total maximum user I/Os are distributed by pin type, including the number of unconnected—i.e., N.C.—pins on the device.

Table 15: Maximum User I/Os by Package

Device	Package	Maximum User I/Os	Maximum Differential Pairs	All Possible I/O Pins by Type					N.C.
				I/O	DUAL	DCI	VREF	GCLK	
XC3S50	VQ100	63	29	22	12	14	7	8	0
XC3S200	VQ100	63	29	22	12	14	7	8	0
XC3S50	TQ144	97	46	51	12	14	12	8	0
XC3S200	TQ144	97	46	51	12	14	12	8	0
XC3S400	TQ144	97	46	51	12	14	12	8	0
XC3S50	PQ208	124	56	72	12	16	16	8	17
XC3S200	PQ208	141	62	83	12	16	22	8	0
XC3S400	PQ208	141	62	83	12	16	22	8	0
XC3S200	FT256	173	76	113	12	16	24	8	0
XC3S400	FT256	173	76	113	12	16	24	8	0
XC3S1000	FT256	173	76	113	12	16	24	8	0
XC3S400	FG320	221	100	156	12	16	29	8	0
XC3S1000	FG320	221	100	156	12	16	29	8	0
XC3S1500	FG320	221	100	156	12	16	29	8	0
XC3S400	FG456	264	116	196	12	16	32	8	69
XC3S1000	FG456	333	149	261	12	16	36	8	0
XC3S1500	FG456	333	149	261	12	16	36	8	0
XC3S1000	FG676	391	175	315	12	16	40	8	98
XC3S1500	FG676	487	221	403	12	16	48	8	2
XC3S2000	FG676	489	221	405	12	16	48	8	0
XC3S2000	FG900	565	270	481	12	16	48	8	68
XC3S4000	FG900	633	300	549	12	16	48	8	0
XC3S5000	FG900	633	300	549	12	16	48	8	0
XC3S4000	FG1156	712	312	621	12	16	55	8	73
XC3S5000	FG1156	784	344	692	12	16	56	8	1

Electronic versions of the package pinout tables and footprints are available for download from the Xilinx website. Using a spreadsheet program, the data can be sorted and reformatted according to any specific needs. Similarly, the

ASCII-text file is easily parsed by most scripting programs. Download the files from the following location:

[http://www.xilinx.com/bvdocs/publications/s3\\_pin.zip](http://www.xilinx.com/bvdocs/publications/s3_pin.zip)

## VQ100: 100-lead Very-thin Quad Flat Package

The XC3S50 and the XC3S200 devices are available in the 100-lead very-thin quad flat package, VQ100. Both devices share a common footprint for this package as shown in [Table 16](#) and [Figure 8](#).

All the package pins appear in [Table 16](#) and are sorted by bank number, then by pin name. Pairs of pins that form a differential I/O pair appear together in the table. The table also shows the pin number for each pin and the pin type, as defined earlier.

### Pinout Table

Table 16: VQ100 Package Pinout

Bank	XC3S50 XC3S200 Pin Name	VQ100 Pin Number	Type
0	IO_L01N_0/VRP_0	P97	DCI
0	IO_L01P_0/VRN_0	P96	DCI
0	IO_L31N_0	P92	I/O
0	IO_L31P_0/VREF_0	P91	VREF
0	IO_L32N_0/GCLK7	P90	GCLK
0	IO_L32P_0/GCLK6	P89	GCLK
0	VCCO_0	P94	VCCO
1	IO	P81	I/O
1	IO_L01N_1/VRP_1	P80	DCI
1	IO_L01P_1/VRN_1	P79	DCI
1	IO_L31N_1/VREF_1	P86	VREF
1	IO_L31P_1	P85	I/O
1	IO_L32N_1/GCLK5	P88	GCLK
1	IO_L32P_1/GCLK4	P87	GCLK
1	VCCO_1	P83	VCCO
2	IO_L01N_2/VRP_2	P75	DCI
2	IO_L01P_2/VRN_2	P74	DCI
2	IO_L21N_2	P72	I/O
2	IO_L21P_2	P71	I/O
2	IO_L24N_2	P68	I/O
2	IO_L24P_2	P67	I/O
2	IO_L40N_2	P65	I/O
2	IO_L40P_2/VREF_2	P64	VREF
2	VCCO_2	P70	VCCO
3	IO	P55	I/O
3	IO	P59	I/O
3	IO_L01N_3/VRP_3	P54	DCI
3	IO_L01P_3/VRN_3	P53	DCI
3	IO_L24N_3	P61	I/O

Table 16: VQ100 Package Pinout

Bank	XC3S50 XC3S200 Pin Name	VQ100 Pin Number	Type
3	IO_L24P_3	P60	I/O
3	IO_L40N_3/VREF_3	P63	VREF
3	IO_L40P_3	P62	I/O
3	VCCO_3	P57	VCCO
4	IO_L01N_4/VRP_4	P50	DCI
4	IO_L01P_4/VRN_4	P49	DCI
4	IO_L27N_4/DIN/D0	P48	DUAL
4	IO_L27P_4/D1	P47	DUAL
4	IO_L30N_4/D2	P44	DUAL
4	IO_L30P_4/D3	P43	DUAL
4	IO_L31N_4/INIT_B	P42	DUAL
4	IO_L31P_4/DOUT/BUSY	P40	DUAL
4	IO_L32N_4/GCLK1	P39	GCLK
4	IO_L32P_4/GCLK0	P38	GCLK
4	VCCO_4	P46	VCCO
5	IO_L01N_5/RDWR_B	P28	DUAL
5	IO_L01P_5/CS_B	P27	DUAL
5	IO_L28N_5/D6	P32	DUAL
5	IO_L28P_5/D7	P30	DUAL
5	IO_L31N_5/D4	P35	DUAL
5	IO_L31P_5/D5	P34	DUAL
5	IO_L32N_5/GCLK3	P37	GCLK
5	IO_L32P_5/GCLK2	P36	GCLK
5	VCCO_5	P31	VCCO
6	IO	P17	I/O
6	IO	P21	I/O
6	IO_L01N_6/VRP_6	P23	DCI
6	IO_L01P_6/VRN_6	P22	DCI
6	IO_L24N_6/VREF_6	P16	VREF
6	IO_L24P_6	P15	I/O
6	IO_L40N_6	P14	I/O
6	IO_L40P_6/VREF_6	P13	VREF
6	VCCO_6	P19	VCCO
7	IO_L01N_7/VRP_7	P2	DCI
7	IO_L01P_7/VRN_7	P1	DCI
7	IO_L21N_7	P5	I/O
7	IO_L21P_7	P4	I/O
7	IO_L23N_7	P9	I/O
7	IO_L23P_7	P8	I/O
7	IO_L40N_7/VREF_7	P12	VREF
7	IO_L40P_7	P11	I/O



Table 16: VQ100 Package Pinout

Bank	XC3S50 XC3S200 Pin Name	VQ100 Pin Number	Type
7	VCCO_7	P6	VCCO
N/A	GND	P3	GND
N/A	GND	P10	GND
N/A	GND	P20	GND
N/A	GND	P29	GND
N/A	GND	P41	GND
N/A	GND	P56	GND
N/A	GND	P66	GND
N/A	GND	P73	GND
N/A	GND	P82	GND
N/A	GND	P95	GND
N/A	VCCAUX	P7	VCCAUX
N/A	VCCAUX	P33	VCCAUX
N/A	VCCAUX	P58	VCCAUX
N/A	VCCAUX	P84	VCCAUX
N/A	VCCINT	P18	VCCINT
N/A	VCCINT	P45	VCCINT
N/A	VCCINT	P69	VCCINT

Table 16: VQ100 Package Pinout

Bank	XC3S50 XC3S200 Pin Name	VQ100 Pin Number	Type
N/A	VCCINT	P93	VCCINT
VCCAUX	CCLK	P52	CONFIG
VCCAUX	DONE	P51	CONFIG
VCCAUX	HSWAP_EN	P98	CONFIG
VCCAUX	M0	P25	CONFIG
VCCAUX	M1	P24	CONFIG
VCCAUX	M2	P26	CONFIG
VCCAUX	PROG_B	P99	CONFIG
VCCAUX	TCK	P77	JTAG
VCCAUX	TDI	P100	JTAG
VCCAUX	TDO	P76	JTAG
VCCAUX	TMS	P78	JTAG

### User I/Os by Bank

Table 17 indicates how the available user-I/O pins are distributed between the eight I/O banks on the VQ100 package.

Table 17: User I/Os Per Bank in VQ100 Package

Package Edge	I/O Bank	Maximum I/O	All Possible I/O Pins by Type				
			I/O	DUAL	DCI	VREF	GCLK
Top	0	6	1	0	2	1	2
	1	7	2	0	2	1	2
Right	2	8	5	0	2	1	0
	3	8	5	0	2	1	0
Bottom	4	10	0	6	2	0	2
	5	8	0	6	0	0	2
Left	6	8	4	0	2	2	0
	7	8	5	0	2	1	0

## VQ100 Footprint

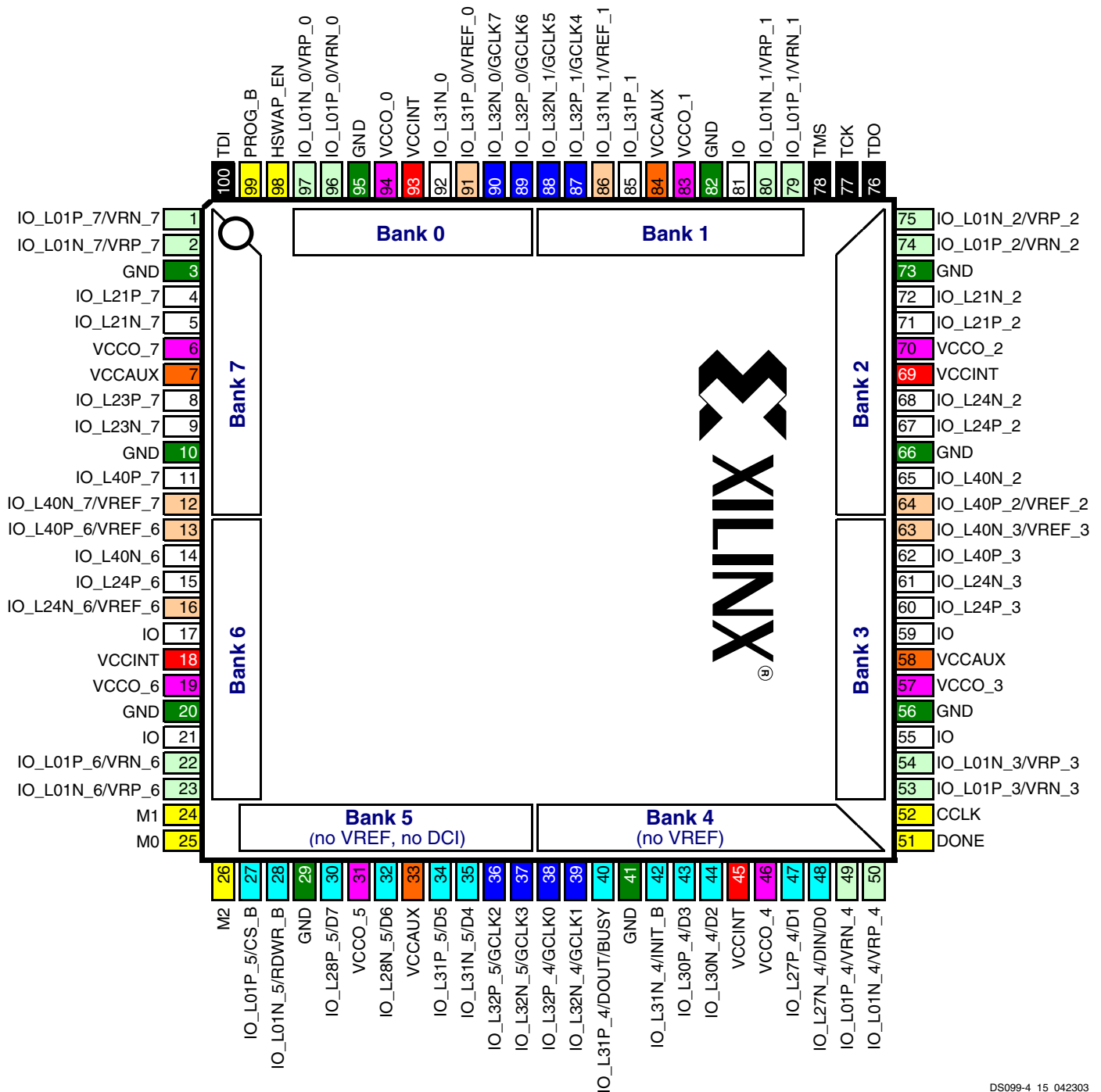

DS099-4\_15\_042303

Figure 8: VQ100 Package Footprint (top view). Note pin 1 indicator in top-left corner and logo orientation.

22	I/O: Unrestricted, general-purpose user I/O	12	DUAL: Configuration pin, then possible user I/O	7	VREF: User I/O or input voltage reference for bank
14	DCI: User I/O or reference resistor input for bank	8	GCLK: User I/O or global clock buffer input	8	VCCO: Output voltage supply for bank
7	CONFIG: Dedicated configuration pins	4	JTAG: Dedicated JTAG port pins	4	VCCINT: Internal core voltage supply (+1.2V)
0	N.C.: No unconnected pins in this package	10	GND: Ground	4	VCCAUX: Auxiliary voltage supply (+2.5V)

## TQ144: 144-lead Thin Quad Flat Package

The XC3S50, the XC3S200, and the XC3S400 are available in the 144-lead thin quad flat package, TQ144. Consequently, there is only one footprint for this package as shown in [Table 18](#) and [Figure 9](#).

The TQ144 package only has four separate VCCO inputs, unlike the other packages, which have eight separate VCCO inputs. The TQ144 package has a separate VCCO input for the top, bottom, left, and right. However, there are still eight separate I/O banks, as shown in [Table 18](#) and [Figure 9](#). Banks 0 and 1 share the VCCO\_TOP input, Banks 2 and 3 share the VCCO\_RIGHT input, Banks 4 and 5 share the VCCO\_BOTTOM input, and Banks 6 and 7 share the VCCO\_LEFT input.

All the package pins appear in [Table 18](#) and are sorted by bank number, then by pin name. Pairs of pins that form a differential I/O pair appear together in the table. The table also shows the pin number for each pin and the pin type, as defined earlier.

### Pinout Table

Table 18: TQ144 Package Pinout

Bank	XC3S50 XC3S200 XC3S400 Pin Name	TQ144 Pin Number	Type
0	IO_L01N_0/VRP_0	P141	DCI
0	IO_L01P_0/VRN_0	P140	DCI
0	IO_L27N_0	P137	I/O
0	IO_L27P_0	P135	I/O
0	IO_L30N_0	P132	I/O
0	IO_L30P_0	P131	I/O
0	IO_L31N_0	P130	I/O
0	IO_L31P_0/VREF_0	P129	VREF
0	IO_L32N_0/GCLK7	P128	GCLK
0	IO_L32P_0/GCLK6	P127	GCLK
1	IO	P116	I/O
1	IO_L01N_1/VRP_1	P113	DCI
1	IO_L01P_1/VRN_1	P112	DCI
1	IO_L28N_1	P119	I/O
1	IO_L28P_1	P118	I/O
1	IO_L31N_1/VREF_1	P123	VREF
1	IO_L31P_1	P122	I/O
1	IO_L32N_1/GCLK5	P125	GCLK
1	IO_L32P_1/GCLK4	P124	GCLK
2	IO_L01N_2/VRP_2	P108	DCI
2	IO_L01P_2/VRN_2	P107	DCI
2	IO_L20N_2	P105	I/O

Table 18: TQ144 Package Pinout (Continued)

Bank	XC3S50 XC3S200 XC3S400 Pin Name	TQ144 Pin Number	Type
2	IO_L20P_2	P104	I/O
2	IO_L21N_2	P103	I/O
2	IO_L21P_2	P102	I/O
2	IO_L22N_2	P100	I/O
2	IO_L22P_2	P99	I/O
2	IO_L23N_2/VREF_2	P98	VREF
2	IO_L23P_2	P97	I/O
2	IO_L24N_2	P96	I/O
2	IO_L24P_2	P95	I/O
2	IO_L40N_2	P93	I/O
2	IO_L40P_2/VREF_2	P92	VREF
3	IO	P76	I/O
3	IO_L01N_3/VRP_3	P74	DCI
3	IO_L01P_3/VRN_3	P73	DCI
3	IO_L20N_3	P78	I/O
3	IO_L20P_3	P77	I/O
3	IO_L21N_3	P80	I/O
3	IO_L21P_3	P79	I/O
3	IO_L22N_3	P83	I/O
3	IO_L22P_3	P82	I/O
3	IO_L23N_3	P85	I/O
3	IO_L23P_3/VREF_3	P84	VREF
3	IO_L24N_3	P87	I/O
3	IO_L24P_3	P86	I/O
3	IO_L40N_3/VREF_3	P90	VREF
3	IO_L40P_3	P89	I/O
4	IO/VREF_4	P70	VREF
4	IO_L01N_4/VRP_4	P69	DCI
4	IO_L01P_4/VRN_4	P68	DCI
4	IO_L27N_4/DIN/D0	P65	DUAL
4	IO_L27P_4/D1	P63	DUAL
4	IO_L30N_4/D2	P60	DUAL
4	IO_L30P_4/D3	P59	DUAL
4	IO_L31N_4/INIT_B	P58	DUAL
4	IO_L31P_4/DOUT/BUSY	P57	DUAL
4	IO_L32N_4/GCLK1	P56	GCLK
4	IO_L32P_4/GCLK0	P55	GCLK
5	IO/VREF_5	P44	VREF
5	IO_L01N_5/RDWR_B	P41	DUAL
5	IO_L01P_5/CS_B	P40	DUAL
5	IO_L28N_5/D6	P47	DUAL

Table 18: TQ144 Package Pinout (Continued)

Bank	XC3S50 XC3S200 XC3S400 Pin Name	TQ144 Pin Number	Type
5	IO_L28P_5/D7	P46	DUAL
5	IO_L31N_5/D4	P51	DUAL
5	IO_L31P_5/D5	P50	DUAL
5	IO_L32N_5/GCLK3	P53	GCLK
5	IO_L32P_5/GCLK2	P52	GCLK
6	IO_L01N_6/VRP_6	P36	DCI
6	IO_L01P_6/VRN_6	P35	DCI
6	IO_L20N_6	P33	I/O
6	IO_L20P_6	P32	I/O
6	IO_L21N_6	P31	I/O
6	IO_L21P_6	P30	I/O
6	IO_L22N_6	P28	I/O
6	IO_L22P_6	P27	I/O
6	IO_L23N_6	P26	I/O
6	IO_L23P_6	P25	I/O
6	IO_L24N_6/VREF_6	P24	VREF
6	IO_L24P_6	P23	I/O
6	IO_L40N_6	P21	I/O
6	IO_L40P_6/VREF_6	P20	VREF
7	IO/VREF_7	P4	VREF
7	IO_L01N_7/VRP_7	P2	DCI
7	IO_L01P_7/VRN_7	P1	DCI
7	IO_L20N_7	P6	I/O
7	IO_L20P_7	P5	I/O
7	IO_L21N_7	P8	I/O
7	IO_L21P_7	P7	I/O
7	IO_L22N_7	P11	I/O
7	IO_L22P_7	P10	I/O
7	IO_L23N_7	P13	I/O
7	IO_L23P_7	P12	I/O
7	IO_L24N_7	P15	I/O
7	IO_L24P_7	P14	I/O
7	IO_L40N_7/VREF_7	P18	VREF
7	IO_L40P_7	P17	I/O
0,1	VCCO_TOP	P126	VCCO
0,1	VCCO_TOP	P138	VCCO
0,1	VCCO_TOP	P115	VCCO
2,3	VCCO_RIGHT	P106	VCCO
2,3	VCCO_RIGHT	P75	VCCO
2,3	VCCO_RIGHT	P91	VCCO
4,5	VCCO_BOTTOM	P54	VCCO

Table 18: TQ144 Package Pinout (Continued)

Bank	XC3S50 XC3S200 XC3S400 Pin Name	TQ144 Pin Number	Type
4,5	VCCO_BOTTOM	P43	VCCO
4,5	VCCO_BOTTOM	P66	VCCO
6,7	VCCO_LEFT	P19	VCCO
6,7	VCCO_LEFT	P34	VCCO
6,7	VCCO_LEFT	P3	VCCO
N/A	GND	P136	GND
N/A	GND	P139	GND
N/A	GND	P114	GND
N/A	GND	P117	GND
N/A	GND	P94	GND
N/A	GND	P101	GND
N/A	GND	P81	GND
N/A	GND	P88	GND
N/A	GND	P64	GND
N/A	GND	P67	GND
N/A	GND	P42	GND
N/A	GND	P45	GND
N/A	GND	P22	GND
N/A	GND	P29	GND
N/A	GND	P9	GND
N/A	GND	P16	GND
N/A	VCCAUX	P134	VCCAUX
N/A	VCCAUX	P120	VCCAUX
N/A	VCCAUX	P62	VCCAUX
N/A	VCCAUX	P48	VCCAUX
N/A	VCCINT	P133	VCCINT
N/A	VCCINT	P121	VCCINT
N/A	VCCINT	P61	VCCINT
N/A	VCCINT	P49	VCCINT
VCCAUX	CCLK	P72	CONFIG
VCCAUX	DONE	P71	CONFIG
VCCAUX	HSWAP_EN	P142	CONFIG
VCCAUX	M0	P38	CONFIG
VCCAUX	M1	P37	CONFIG
VCCAUX	M2	P39	CONFIG
VCCAUX	PROG_B	P143	CONFIG
VCCAUX	TCK	P110	JTAG
VCCAUX	TDI	P144	JTAG
VCCAUX	TDO	P109	JTAG
VCCAUX	TMS	P111	JTAG

## User I/Os by Bank

Table 19 indicates how the available user-I/O pins are distributed between the eight I/O banks on the TQ144 package.

Table 19: User I/Os Per Bank in TQ144 Package

Package Edge	I/O Bank	Maximum I/O	All Possible I/O Pins by Type				
			I/O	DUAL	DCI	VREF	GCLK
Top	0	10	5	0	2	1	2
	1	9	4	0	2	1	2
Right	2	14	10	0	2	2	0
	3	15	11	0	2	2	0
Bottom	4	11	0	6	2	1	2
	5	9	0	6	0	1	2
Left	6	14	10	0	2	2	0
	7	15	11	0	2	2	0

## TQ144 Footprint

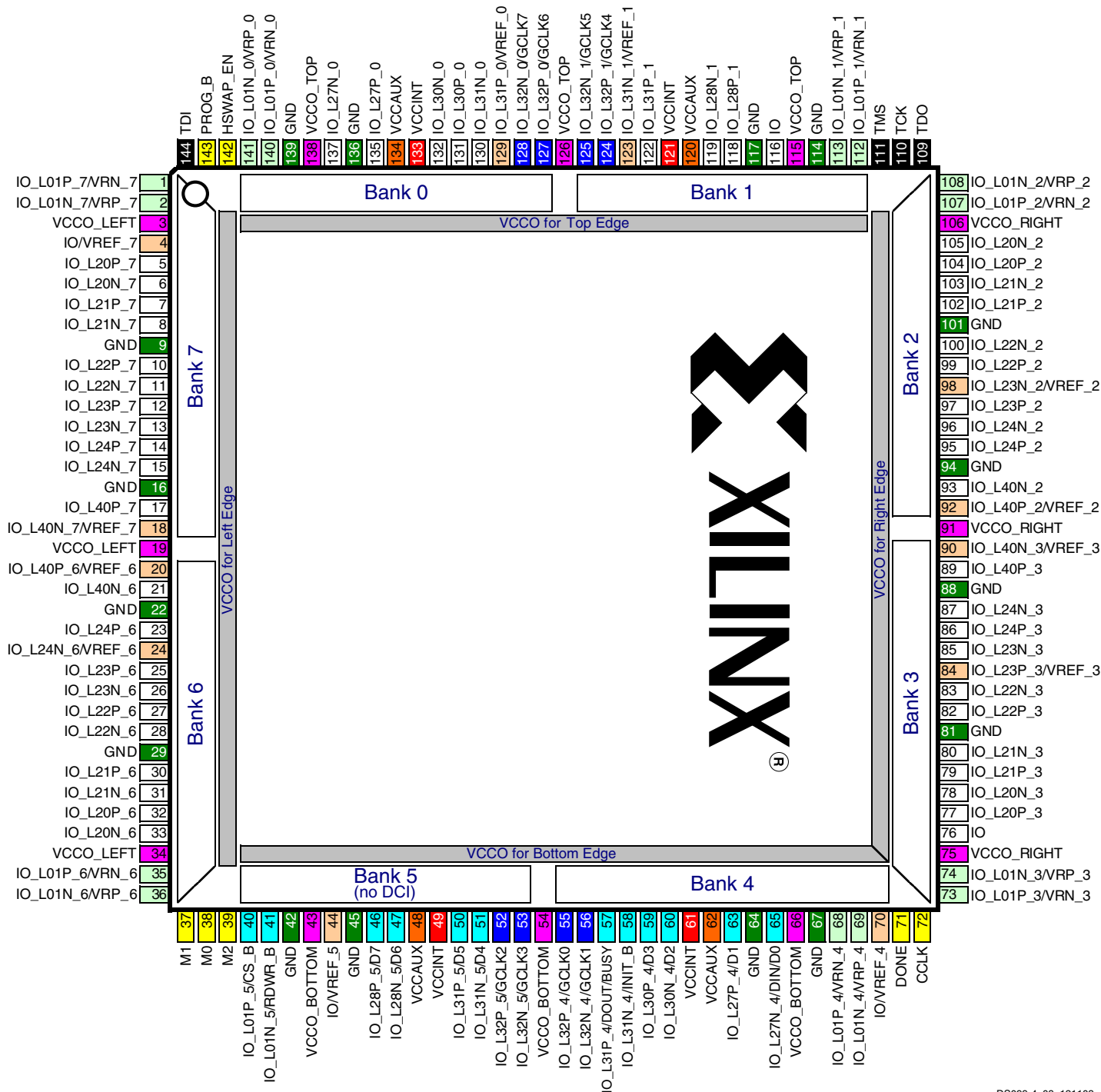

DS099-4\_08\_121103

Figure 9: TQ144 Package Footprint (top view). Note pin 1 indicator in top-left corner and logo orientation.

51	I/O: Unrestricted, general-purpose user I/O	12	DUAL: Configuration pin, then possible user I/O	12	VREF: User I/O or input voltage reference for bank
14	DCI: User I/O or reference resistor input for bank	8	GCLK: User I/O or global clock buffer input	12	VCCO: Output voltage supply for bank
7	CONFIG: Dedicated configuration pins	4	JTAG: Dedicated JTAG port pins	4	VCCINT: Internal core voltage supply (+1.2V)
0	N.C.: No unconnected pins in this package	16	GND: Ground	4	VCCAUX: Auxiliary voltage supply (+2.5V)

## PQ208: 208-lead Plastic Quad Flat Pack

The 208-lead plastic quad flat package, PQ208, supports three different Spartan-3 devices, including the XC3S50, the XC3S200, and the XC3S400. The footprints for the XC3S200 and XC3S400 are identical, as shown in [Table 20](#) and [Figure 10](#). The XC3S50, however, has fewer I/O pins resulting in 17 unconnected pins on the PQ208 package, labeled as “N.C.” In [Table 20](#) and [Figure 10](#), these unconnected pins are indicated with a black diamond symbol (◆).

All the package pins appear in [Table 20](#) and are sorted by bank number, then by pin name. Pairs of pins that form a differential I/O pair appear together in the table. The table also shows the pin number for each pin and the pin type, as defined earlier.

If there is a difference between the XC3S50 pinout and the pinout for the XC3S200 and XC3S400, then that difference is highlighted in [Table 20](#). If the table entry is shaded grey, then there is an unconnected pin on the XC3S50 that maps to a user-I/O pin on the XC3S200 and XC3S400. If the table entry is shaded tan, then the unconnected pin on the XC3S50 maps to a VREF-type pin on the XC3S200 and XC3S400. If the other VREF pins in the bank all connect to a voltage reference to support a special I/O standard, then also connect the N.C. pin on the XC3S50 to the same VREF voltage. This provides maximum flexibility as you could potentially migrate a design from the XC3S50 device to an XC3S200 or XC3S400 FPGA without changing the printed circuit board.

### Pinout Table

Table 20: PQ208 Package Pinout

Bank	XC3S50 Pin Name	XC3S200 XC3S400 Pin Name	PQ208 Pin Number	Type
0	IO	IO	P189	I/O
0	IO	IO	P197	I/O
0	N.C. (◆)	IO/VREF_0	P200	VREF
0	IO/VREF_0	IO/VREF_0	P205	VREF
0	IO_L01N_0/ VRP_0	IO_L01N_0/ VRP_0	P204	DCI
0	IO_L01P_0/ VRN_0	IO_L01P_0/ VRN_0	P203	DCI
0	IO_L25N_0	IO_L25N_0	P199	I/O
0	IO_L25P_0	IO_L25P_0	P198	I/O
0	IO_L27N_0	IO_L27N_0	P196	I/O
0	IO_L27P_0	IO_L27P_0	P194	I/O
0	IO_L30N_0	IO_L30N_0	P191	I/O
0	IO_L30P_0	IO_L30P_0	P190	I/O
0	IO_L31N_0	IO_L31N_0	P187	I/O
0	IO_L31P_0/ VREF_0	IO_L31P_0/ VREF_0	P185	VREF

Table 20: PQ208 Package Pinout (Continued)

Bank	XC3S50 Pin Name	XC3S200 XC3S400 Pin Name	PQ208 Pin Number	Type
0	IO_L32N_0/ GCLK7	IO_L32N_0/ GCLK7	P184	GCLK
0	IO_L32P_0/ GCLK6	IO_L32P_0/ GCLK6	P183	GCLK
0	VCCO_0	VCCO_0	P188	VCCO
0	VCCO_0	VCCO_0	P201	VCCO
1	IO	IO	P167	I/O
1	IO	IO	P175	I/O
1	IO	IO	P182	I/O
1	IO_L01N_1/ VRP_1	IO_L01N_1/ VRP_1	P162	DCI
1	IO_L01P_1/ VRN_1	IO_L01P_1/ VRN_1	P161	DCI
1	IO_L10N_1/ VREF_1	IO_L10N_1/ VREF_1	P166	VREF
1	IO_L10P_1	IO_L10P_1	P165	I/O
1	IO_L27N_1	IO_L27N_1	P169	I/O
1	IO_L27P_1	IO_L27P_1	P168	I/O
1	IO_L28N_1	IO_L28N_1	P172	I/O
1	IO_L28P_1	IO_L28P_1	P171	I/O
1	IO_L31N_1/ VREF_1	IO_L31N_1/ VREF_1	P178	VREF
1	IO_L31P_1	IO_L31P_1	P176	I/O
1	IO_L32N_1/ GCLK5	IO_L32N_1/ GCLK5	P181	GCLK
1	IO_L32P_1/ GCLK4	IO_L32P_1/ GCLK4	P180	GCLK
1	VCCO_1	VCCO_1	P164	VCCO
1	VCCO_1	VCCO_1	P177	VCCO
2	N.C. (◆)	IO/VREF_2	P154	VREF
2	IO_L01N_2/ VRP_2	IO_L01N_2/ VRP_2	P156	DCI
2	IO_L01P_2/ VRN_2	IO_L01P_2/ VRN_2	P155	DCI
2	IO_L19N_2	IO_L19N_2	P152	I/O
2	IO_L19P_2	IO_L19P_2	P150	I/O
2	IO_L20N_2	IO_L20N_2	P149	I/O
2	IO_L20P_2	IO_L20P_2	P148	I/O
2	IO_L21N_2	IO_L21N_2	P147	I/O
2	IO_L21P_2	IO_L21P_2	P146	I/O
2	IO_L22N_2	IO_L22N_2	P144	I/O
2	IO_L22P_2	IO_L22P_2	P143	I/O
2	IO_L23N_2/ VREF_2	IO_L23N_2/ VREF_2	P141	VREF
2	IO_L23P_2	IO_L23P_2	P140	I/O

Table 20: PQ208 Package Pinout (Continued)

Bank	XC3S50 Pin Name	XC3S200 XC3S400 Pin Name	PQ208 Pin Number	Type
2	IO_L24N_2	IO_L24N_2	P139	I/O
2	IO_L24P_2	IO_L24P_2	P138	I/O
2	N.C. (◆)	IO_L39N_2	P137	I/O
2	N.C. (◆)	IO_L39P_2	P135	I/O
2	IO_L40N_2	IO_L40N_2	P133	I/O
2	IO_L40P_2/ VREF_2	IO_L40P_2/ VREF_2	P132	VREF
2	VCCO_2	VCCO_2	P136	VCCO
2	VCCO_2	VCCO_2	P153	VCCO
3	IO_L01N_3/ VRP_3	IO_L01N_3/ VRP_3	P107	DCI
3	IO_L01P_3/ VRN_3	IO_L01P_3/ VRN_3	P106	DCI
3	N.C. (◆)	IO_L17N_3	P109	I/O
3	N.C. (◆)	IO_L17P_3/ VREF_3	P108	VREF
3	IO_L19N_3	IO_L19N_3	P113	I/O
3	IO_L19P_3	IO_L19P_3	P111	I/O
3	IO_L20N_3	IO_L20N_3	P115	I/O
3	IO_L20P_3	IO_L20P_3	P114	I/O
3	IO_L21N_3	IO_L21N_3	P117	I/O
3	IO_L21P_3	IO_L21P_3	P116	I/O
3	IO_L22N_3	IO_L22N_3	P120	I/O
3	IO_L22P_3	IO_L22P_3	P119	I/O
3	IO_L23N_3	IO_L23N_3	P123	I/O
3	IO_L23P_3/ VREF_3	IO_L23P_3/ VREF_3	P122	VREF
3	IO_L24N_3	IO_L24N_3	P125	I/O
3	IO_L24P_3	IO_L24P_3	P124	I/O
3	N.C. (◆)	IO_L39N_3	P128	I/O
3	N.C. (◆)	IO_L39P_3	P126	I/O
3	IO_L40N_3/ VREF_3	IO_L40N_3/ VREF_3	P131	VREF
3	IO_L40P_3	IO_L40P_3	P130	I/O
3	VCCO_3	VCCO_3	P110	VCCO
3	VCCO_3	VCCO_3	P127	VCCO
4	IO	IO	P93	I/O
4	N.C. (◆)	IO	P97	I/O
4	IO/VREF_4	IO/VREF_4	P85	VREF
4	N.C. (◆)	IO/VREF_4	P96	VREF
4	IO/VREF_4	IO/VREF_4	P102	VREF
4	IO_L01N_4/ VRP_4	IO_L01N_4/ VRP_4	P101	DCI

Table 20: PQ208 Package Pinout (Continued)

Bank	XC3S50 Pin Name	XC3S200 XC3S400 Pin Name	PQ208 Pin Number	Type
4	IO_L01P_4/ VRN_4	IO_L01P_4/ VRN_4	P100	DCI
4	IO_L25N_4	IO_L25N_4	P95	I/O
4	IO_L25P_4	IO_L25P_4	P94	I/O
4	IO_L27N_4/ DIN/D0	IO_L27N_4/ DIN/D0	P92	DUAL
4	IO_L27P_4/ D1	IO_L27P_4/ D1	P90	DUAL
4	IO_L30N_4/ D2	IO_L30N_4/ D2	P87	DUAL
4	IO_L30P_4/ D3	IO_L30P_4/ D3	P86	DUAL
4	IO_L31N_4/ INIT_B	IO_L31N_4/ INIT_B	P83	DUAL
4	IO_L31P_4/ DOUT/BUSY	IO_L31P_4/ DOUT/BUSY	P81	DUAL
4	IO_L32N_4/ GCLK1	IO_L32N_4/ GCLK1	P80	GCLK
4	IO_L32P_4/ GCLK0	IO_L32P_4/ GCLK0	P79	GCLK
4	VCCO_4	VCCO_4	P84	VCCO
4	VCCO_4	VCCO_4	P98	VCCO
5	IO	IO	P63	I/O
5	IO	IO	P71	I/O
5	IO/VREF_5	IO/VREF_5	P78	VREF
5	IO_L01N_5/ RDWR_B	IO_L01N_5/ RDWR_B	P58	DUAL
5	IO_L01P_5/ CS_B	IO_L01P_5/ CS_B	P57	DUAL
5	IO_L10N_5/ VRP_5	IO_L10N_5/ VRP_5	P62	DCI
5	IO_L10P_5/ VRN_5	IO_L10P_5/ VRN_5	P61	DCI
5	IO_L27N_5/ VREF_5	IO_L27N_5/ VREF_5	P65	VREF
5	IO_L27P_5	IO_L27P_5	P64	I/O
5	IO_L28N_5/ D6	IO_L28N_5/ D6	P68	DUAL
5	IO_L28P_5/ D7	IO_L28P_5/ D7	P67	DUAL
5	IO_L31N_5/ D4	IO_L31N_5/ D4	P74	DUAL
5	IO_L31P_5/ D5	IO_L31P_5/ D5	P72	DUAL
5	IO_L32N_5/ GCLK3	IO_L32N_5/ GCLK3	P77	GCLK



**Table 20: PQ208 Package Pinout (Continued)**

Bank	XC3S50 Pin Name	XC3S200 XC3S400 Pin Name	PQ208 Pin Number	Type
5	IO_L32P_5/ GCLK2	IO_L32P_5/ GCLK2	P76	GCLK
5	VCCO_5	VCCO_5	P60	VCCO
5	VCCO_5	VCCO_5	P73	VCCO
6	N.C. (◆)	IO/VREF_6	P50	VREF
6	IO_L01N_6/ VRP_6	IO_L01N_6/ VRP_6	P52	DCI
6	IO_L01P_6/ VRN_6	IO_L01P_6/ VRN_6	P51	DCI
6	IO_L19N_6	IO_L19N_6	P48	I/O
6	IO_L19P_6	IO_L19P_6	P46	I/O
6	IO_L20N_6	IO_L20N_6	P45	I/O
6	IO_L20P_6	IO_L20P_6	P44	I/O
6	IO_L21N_6	IO_L21N_6	P43	I/O
6	IO_L21P_6	IO_L21P_6	P42	I/O
6	IO_L22N_6	IO_L22N_6	P40	I/O
6	IO_L22P_6	IO_L22P_6	P39	I/O
6	IO_L23N_6	IO_L23N_6	P37	I/O
6	IO_L23P_6	IO_L23P_6	P36	I/O
6	IO_L24N_6/ VREF_6	IO_L24N_6/ VREF_6	P35	VREF
6	IO_L24P_6	IO_L24P_6	P34	I/O
6	N.C. (◆)	IO_L39N_6	P33	I/O
6	N.C. (◆)	IO_L39P_6	P31	I/O
6	IO_L40N_6	IO_L40N_6	P29	I/O
6	IO_L40P_6/ VREF_6	IO_L40P_6/ VREF_6	P28	VREF
6	VCCO_6	VCCO_6	P32	VCCO
6	VCCO_6	VCCO_6	P49	VCCO
7	IO_L01N_7/ VRP_7	IO_L01N_7/ VRP_7	P3	DCI
7	IO_L01P_7/ VRN_7	IO_L01P_7/ VRN_7	P2	DCI
7	N.C. (◆)	IO_L16N_7	P5	I/O
7	N.C. (◆)	IO_L16P_7/ VREF_7	P4	VREF
7	IO_L19N_7/ VREF_7	IO_L19N_7/ VREF_7	P9	VREF
7	IO_L19P_7	IO_L19P_7	P7	I/O
7	IO_L20N_7	IO_L20N_7	P11	I/O
7	IO_L20P_7	IO_L20P_7	P10	I/O
7	IO_L21N_7	IO_L21N_7	P13	I/O
7	IO_L21P_7	IO_L21P_7	P12	I/O
7	IO_L22N_7	IO_L22N_7	P16	I/O

**Table 20: PQ208 Package Pinout (Continued)**

Bank	XC3S50 Pin Name	XC3S200 XC3S400 Pin Name	PQ208 Pin Number	Type
7	IO_L22P_7	IO_L22P_7	P15	I/O
7	IO_L23N_7	IO_L23N_7	P19	I/O
7	IO_L23P_7	IO_L23P_7	P18	I/O
7	IO_L24N_7	IO_L24N_7	P21	I/O
7	IO_L24P_7	IO_L24P_7	P20	I/O
7	N.C. (◆)	IO_L39N_7	P24	I/O
7	N.C. (◆)	IO_L39P_7	P22	I/O
7	IO_L40N_7/ VREF_7	IO_L40N_7/ VREF_7	P27	VREF
7	IO_L40P_7	IO_L40P_7	P26	I/O
7	VCCO_7	VCCO_7	P6	VCCO
7	VCCO_7	VCCO_7	P23	VCCO
N/A	GND	GND	P1	GND
N/A	GND	GND	P186	GND
N/A	GND	GND	P195	GND
N/A	GND	GND	P202	GND
N/A	GND	GND	P163	GND
N/A	GND	GND	P170	GND
N/A	GND	GND	P179	GND
N/A	GND	GND	P134	GND
N/A	GND	GND	P145	GND
N/A	GND	GND	P151	GND
N/A	GND	GND	P157	GND
N/A	GND	GND	P112	GND
N/A	GND	GND	P118	GND
N/A	GND	GND	P129	GND
N/A	GND	GND	P82	GND
N/A	GND	GND	P91	GND
N/A	GND	GND	P99	GND
N/A	GND	GND	P105	GND
N/A	GND	GND	P53	GND
N/A	GND	GND	P59	GND
N/A	GND	GND	P66	GND
N/A	GND	GND	P75	GND
N/A	GND	GND	P30	GND
N/A	GND	GND	P41	GND
N/A	GND	GND	P47	GND
N/A	GND	GND	P8	GND
N/A	GND	GND	P14	GND
N/A	GND	GND	P25	GND
N/A	VCCAUX	VCCAUX	P193	VCCAUX
N/A	VCCAUX	VCCAUX	P173	VCCAUX

Table 20: PQ208 Package Pinout (Continued)

Bank	XC3S50 Pin Name	XC3S200 XC3S400 Pin Name	PQ208 Pin Number	Type
N/A	VCCAUX	VCCAUX	P142	VCCAUX
N/A	VCCAUX	VCCAUX	P121	VCCAUX
N/A	VCCAUX	VCCAUX	P89	VCCAUX
N/A	VCCAUX	VCCAUX	P69	VCCAUX
N/A	VCCAUX	VCCAUX	P38	VCCAUX
N/A	VCCAUX	VCCAUX	P17	VCCAUX
N/A	VCCINT	VCCINT	P192	VCCINT
N/A	VCCINT	VCCINT	P174	VCCINT
N/A	VCCINT	VCCINT	P88	VCCINT
N/A	VCCINT	VCCINT	P70	VCCINT
VCCAUX	CCLK	CCLK	P104	CONFIG
VCCAUX	DONE	DONE	P103	CONFIG
VCCAUX	HSWAP_EN	HSWAP_EN	P206	CONFIG
VCCAUX	M0	M0	P55	CONFIG

Table 20: PQ208 Package Pinout (Continued)

Bank	XC3S50 Pin Name	XC3S200 XC3S400 Pin Name	PQ208 Pin Number	Type
VCCAUX	M1	M1	P54	CONFIG
VCCAUX	M2	M2	P56	CONFIG
VCCAUX	PROG_B	PROG_B	P207	CONFIG
VCCAUX	TCK	TCK	P159	JTAG
VCCAUX	TDI	TDI	P208	JTAG
VCCAUX	TDO	TDO	P158	JTAG
VCCAUX	TMS	TMS	P160	JTAG

### User I/Os by Bank

Table 21 indicates how the available user-I/O pins are distributed between the eight I/O banks for the XC3S50 in the PQ208 package. Similarly, Table 22 shows how the available user-I/O pins are distributed between the eight I/O banks for the XC3S200 and XC3S400 in the PQ208 package.

Table 21: User I/Os Per Bank for XC3S50 in PQ208 Package

Package Edge	I/O Bank	Maximum I/O	All Possible I/O Pins by Type				
			I/O	DUAL	DCI	VREF	GCLK
Top	0	15	9	0	2	2	2
	1	15	9	0	2	2	2
Right	2	16	13	0	2	2	0
	3	16	12	0	2	2	0
Bottom	4	15	3	6	2	2	2
	5	15	3	6	2	2	2
Left	6	16	12	0	2	2	0
	7	16	12	0	2	2	0

Table 22: User I/Os Per Bank for XC3S200 and XC3S400 in PQ208 Package

Package Edge	I/O Bank	Maximum I/O	All Possible I/O Pins by Type				
			I/O	DUAL	DCI	VREF	GCLK
Top	0	16	9	0	2	3	2
	1	15	9	0	2	2	2
Right	2	19	14	0	2	3	0
	3	20	15	0	2	3	0
Bottom	4	17	4	6	2	3	2
	5	15	3	6	2	2	2
Left	6	19	14	0	2	3	0
	7	20	15	0	2	3	0

## PQ208 Footprint

### Left Half of Package (top view)

#### XC3S50

(124 max. user I/O)

72 I/O: Unrestricted, general-purpose user I/O

16 VREF: User I/O or input voltage reference for bank

17 N.C.: Unconnected pins for XC3S50 (◆)

#### XC3S200, XC3S400

(141 max user I/O)

83 I/O: Unrestricted, general-purpose user I/O

22 VREF: User I/O or input voltage reference for bank

0 N.C.: No unconnected pins in this package

#### All devices

12 DUAL: Configuration pin, then possible user I/O

8 GCLK: User I/O or global clock buffer input

16 DCI: User I/O or reference resistor input for bank

7 CONFIG: Dedicated configuration pins

4 JTAG: Dedicated JTAG port pins

4 VCCINT: Internal core voltage supply (+1.2V)

12 VCCO: Output voltage supply for bank

8 VCCAUX: Auxiliary voltage supply (+2.5V)

28 GND: Ground

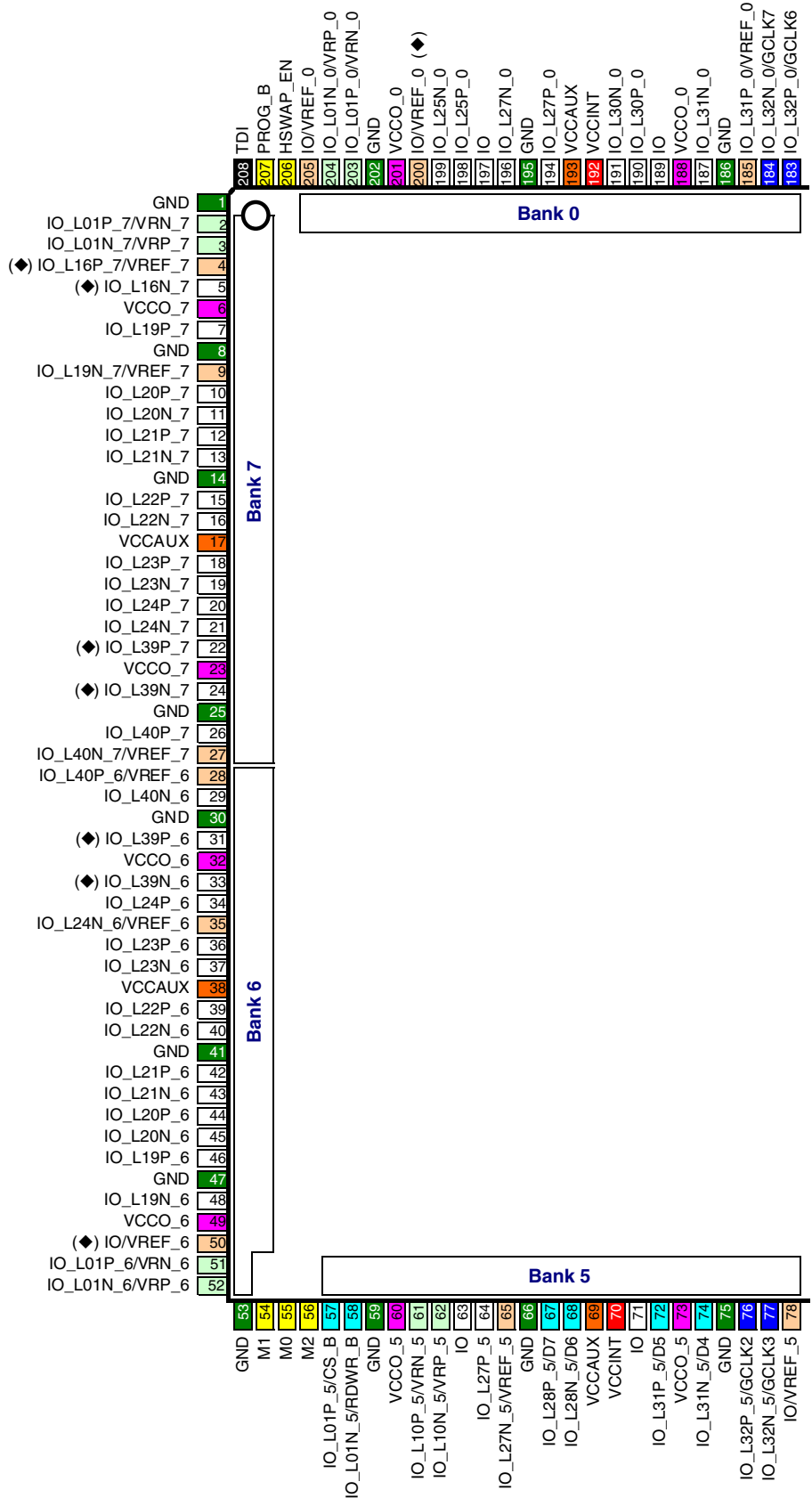

DS099-4\_09a\_121103

Figure 10: PQ208 Package Footprint (top view). Note pin 1 indicator in top-left corner and logo orientation.

Right Half of Package  
(top view)

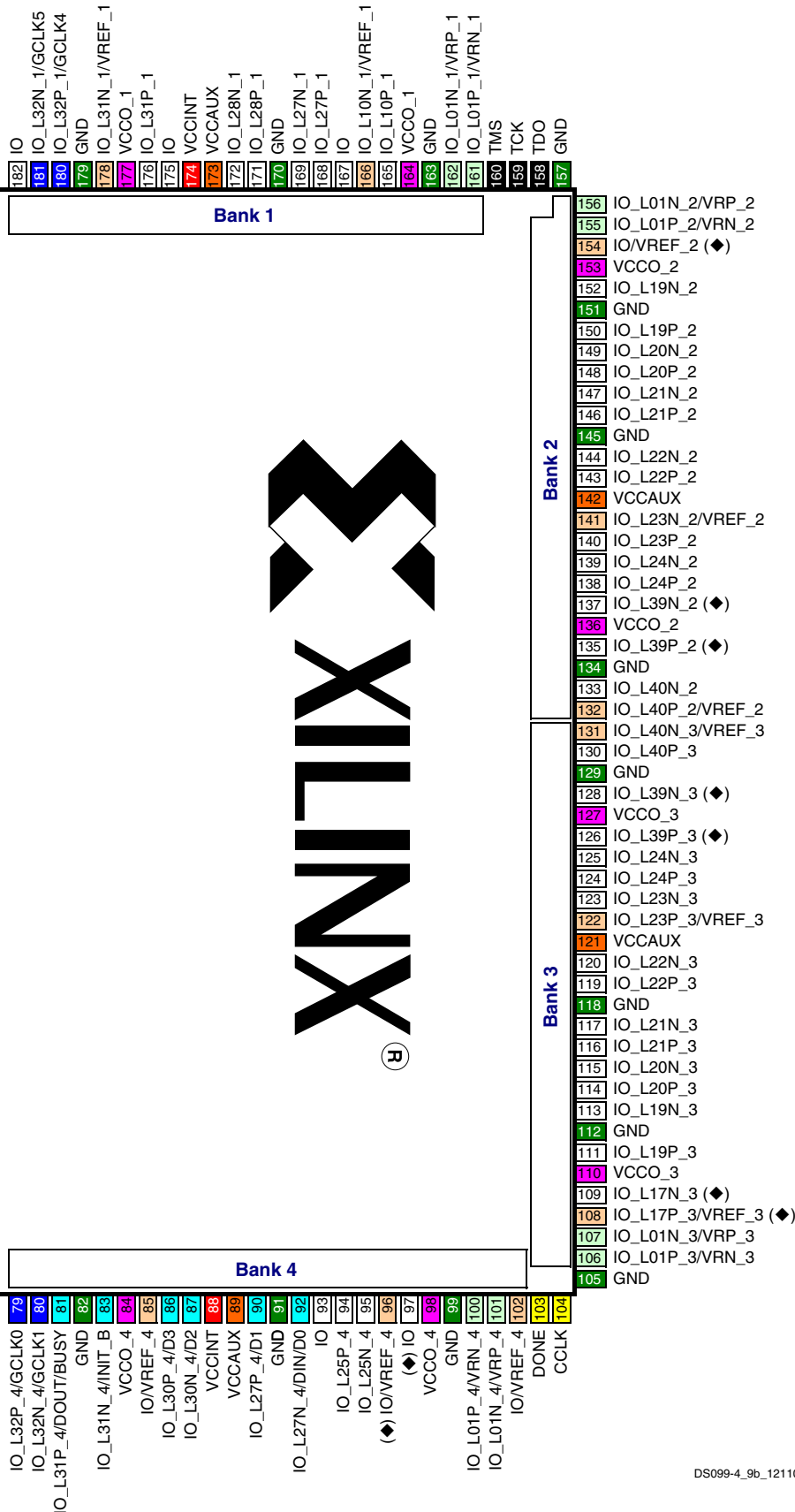

DS099-4\_9b\_121103

## FT256: 256-lead Fine-pitch Thin Ball Grid Array

The 256-lead fine-pitch thin ball grid array package, FT256, supports three different Spartan-3 devices, including the XC3S200, the XC3S400, and the XC3S1000. The footprints for all three devices are identical, as shown in [Table 23](#) and [Figure 11](#).

All the package pins appear in [Table 23](#) and are sorted by bank number, then by pin name. Pairs of pins that form a differential I/O pair appear together in the table. The table also shows the pin number for each pin and the pin type, as defined earlier.

### Pinout Table

Table 23: FT256 Package Pinout

Bank	XC3S200 XC3S400 XC3S1000 Pin Name	FT256 Pin Number	Type
0	IO	A5	I/O
0	IO	A7	I/O
0	IO/VREF_0	A3	VREF
0	IO/VREF_0	D5	VREF
0	IO_L01N_0/VRP_0	B4	DCI
0	IO_L01P_0/VRN_0	A4	DCI
0	IO_L25N_0	C5	I/O
0	IO_L25P_0	B5	I/O
0	IO_L27N_0	E6	I/O
0	IO_L27P_0	D6	I/O
0	IO_L28N_0	C6	I/O
0	IO_L28P_0	B6	I/O
0	IO_L29N_0	E7	I/O
0	IO_L29P_0	D7	I/O
0	IO_L30N_0	C7	I/O
0	IO_L30P_0	B7	I/O
0	IO_L31N_0	D8	I/O
0	IO_L31P_0/VREF_0	C8	VREF
0	IO_L32N_0/GCLK7	B8	GCLK
0	IO_L32P_0/GCLK6	A8	GCLK
0	VCCO_0	E8	VCCO
0	VCCO_0	F7	VCCO
0	VCCO_0	F8	VCCO
1	IO	A9	I/O
1	IO	A12	I/O
1	IO	C10	I/O
1	IO/VREF_1	D12	VREF
1	IO_L01N_1/VRP_1	A14	DCI

Table 23: FT256 Package Pinout (Continued)

Bank	XC3S200 XC3S400 XC3S1000 Pin Name	FT256 Pin Number	Type
1	IO_L01P_1/VRN_1	B14	DCI
1	IO_L10N_1/VREF_1	A13	VREF
1	IO_L10P_1	B13	I/O
1	IO_L27N_1	B12	I/O
1	IO_L27P_1	C12	I/O
1	IO_L28N_1	D11	I/O
1	IO_L28P_1	E11	I/O
1	IO_L29N_1	B11	I/O
1	IO_L29P_1	C11	I/O
1	IO_L30N_1	D10	I/O
1	IO_L30P_1	E10	I/O
1	IO_L31N_1/VREF_1	A10	VREF
1	IO_L31P_1	B10	I/O
1	IO_L32N_1/GCLK5	C9	GCLK
1	IO_L32P_1/GCLK4	D9	GCLK
1	VCCO_1	E9	VCCO
1	VCCO_1	F9	VCCO
1	VCCO_1	F10	VCCO
2	IO	G16	I/O
2	IO_L01N_2/VRP_2	B16	DCI
2	IO_L01P_2/VRN_2	C16	DCI
2	IO_L16N_2	C15	I/O
2	IO_L16P_2	D14	I/O
2	IO_L17N_2	D15	I/O
2	IO_L17P_2/VREF_2	D16	VREF
2	IO_L19N_2	E13	I/O
2	IO_L19P_2	E14	I/O
2	IO_L20N_2	E15	I/O
2	IO_L20P_2	E16	I/O
2	IO_L21N_2	F12	I/O
2	IO_L21P_2	F13	I/O
2	IO_L22N_2	F14	I/O
2	IO_L22P_2	F15	I/O
2	IO_L23N_2/VREF_2	G12	VREF
2	IO_L23P_2	G13	I/O
2	IO_L24N_2	G14	I/O
2	IO_L24P_2	G15	I/O
2	IO_L39N_2	H13	I/O
2	IO_L39P_2	H14	I/O
2	IO_L40N_2	H15	I/O

Table 23: FT256 Package Pinout (Continued)

Bank	XC3S200 XC3S400 XC3S1000 Pin Name	FT256 Pin Number	Type
2	IO_L40P_2/VREF_2	H16	VREF
2	VCCO_2	G11	VCCO
2	VCCO_2	H11	VCCO
2	VCCO_2	H12	VCCO
3	IO	K15	I/O
3	IO_L01N_3/VRP_3	P16	DCI
3	IO_L01P_3/VRN_3	R16	DCI
3	IO_L16N_3	P15	I/O
3	IO_L16P_3	P14	I/O
3	IO_L17N_3	N16	I/O
3	IO_L17P_3/VREF_3	N15	VREF
3	IO_L19N_3	M14	I/O
3	IO_L19P_3	N14	I/O
3	IO_L20N_3	M16	I/O
3	IO_L20P_3	M15	I/O
3	IO_L21N_3	L13	I/O
3	IO_L21P_3	M13	I/O
3	IO_L22N_3	L15	I/O
3	IO_L22P_3	L14	I/O
3	IO_L23N_3	K12	I/O
3	IO_L23P_3/VREF_3	L12	VREF
3	IO_L24N_3	K14	I/O
3	IO_L24P_3	K13	I/O
3	IO_L39N_3	J14	I/O
3	IO_L39P_3	J13	I/O
3	IO_L40N_3/VREF_3	J16	VREF
3	IO_L40P_3	K16	I/O
3	VCCO_3	J11	VCCO
3	VCCO_3	J12	VCCO
3	VCCO_3	K11	VCCO
4	IO	T12	I/O
4	IO	T14	I/O
4	IO/VREF_4	N12	VREF
4	IO/VREF_4	P13	VREF
4	IO/VREF_4	T10	VREF
4	IO_L01N_4/VRP_4	R13	DCI
4	IO_L01P_4/VRN_4	T13	DCI
4	IO_L25N_4	P12	I/O
4	IO_L25P_4	R12	I/O
4	IO_L27N_4/DIN/D0	M11	DUAL

Table 23: FT256 Package Pinout (Continued)

Bank	XC3S200 XC3S400 XC3S1000 Pin Name	FT256 Pin Number	Type
4	IO_L27P_4/D1	N11	DUAL
4	IO_L28N_4	P11	I/O
4	IO_L28P_4	R11	I/O
4	IO_L29N_4	M10	I/O
4	IO_L29P_4	N10	I/O
4	IO_L30N_4/D2	P10	DUAL
4	IO_L30P_4/D3	R10	DUAL
4	IO_L31N_4/INIT_B	N9	DUAL
4	IO_L31P_4/DOOUT/BUSY	P9	DUAL
4	IO_L32N_4/GCLK1	R9	GCLK
4	IO_L32P_4/GCLK0	T9	GCLK
4	VCCO_4	L9	VCCO
4	VCCO_4	L10	VCCO
4	VCCO_4	M9	VCCO
5	IO	N5	I/O
5	IO	P7	I/O
5	IO	T5	I/O
5	IO/VREF_5	T8	VREF
5	IO_L01N_5/RDWR_B	T3	DUAL
5	IO_L01P_5/CS_B	R3	DUAL
5	IO_L10N_5/VRP_5	T4	DCI
5	IO_L10P_5/VRN_5	R4	DCI
5	IO_L27N_5/VREF_5	R5	VREF
5	IO_L27P_5	P5	I/O
5	IO_L28N_5/D6	N6	DUAL
5	IO_L28P_5/D7	M6	DUAL
5	IO_L29N_5	R6	I/O
5	IO_L29P_5/VREF_5	P6	VREF
5	IO_L30N_5	N7	I/O
5	IO_L30P_5	M7	I/O
5	IO_L31N_5/D4	T7	DUAL
5	IO_L31P_5/D5	R7	DUAL
5	IO_L32N_5/GCLK3	P8	GCLK
5	IO_L32P_5/GCLK2	N8	GCLK
5	VCCO_5	L7	VCCO
5	VCCO_5	L8	VCCO
5	VCCO_5	M8	VCCO
6	IO	K1	I/O
6	IO_L01N_6/VRP_6	R1	DCI
6	IO_L01P_6/VRN_6	P1	DCI

Table 23: FT256 Package Pinout (Continued)

Bank	XC3S200 XC3S400 XC3S1000 Pin Name	FT256 Pin Number	Type
6	IO_L16N_6	P2	I/O
6	IO_L16P_6	N3	I/O
6	IO_L17N_6	N2	I/O
6	IO_L17P_6/VREF_6	N1	VREF
6	IO_L19N_6	M4	I/O
6	IO_L19P_6	M3	I/O
6	IO_L20N_6	M2	I/O
6	IO_L20P_6	M1	I/O
6	IO_L21N_6	L5	I/O
6	IO_L21P_6	L4	I/O
6	IO_L22N_6	L3	I/O
6	IO_L22P_6	L2	I/O
6	IO_L23N_6	K5	I/O
6	IO_L23P_6	K4	I/O
6	IO_L24N_6/VREF_6	K3	VREF
6	IO_L24P_6	K2	I/O
6	IO_L39N_6	J4	I/O
6	IO_L39P_6	J3	I/O
6	IO_L40N_6	J2	I/O
6	IO_L40P_6/VREF_6	J1	VREF
6	VCCO_6	J5	VCCO
6	VCCO_6	J6	VCCO
6	VCCO_6	K6	VCCO
7	IO	G2	I/O
7	IO_L01N_7/VRP_7	C1	DCI
7	IO_L01P_7/VRN_7	B1	DCI
7	IO_L16N_7	C2	I/O
7	IO_L16P_7/VREF_7	C3	VREF
7	IO_L17N_7	D1	I/O
7	IO_L17P_7	D2	I/O
7	IO_L19N_7/VREF_7	E3	VREF
7	IO_L19P_7	D3	I/O
7	IO_L20N_7	E1	I/O
7	IO_L20P_7	E2	I/O
7	IO_L21N_7	F4	I/O
7	IO_L21P_7	E4	I/O
7	IO_L22N_7	F2	I/O
7	IO_L22P_7	F3	I/O
7	IO_L23N_7	G5	I/O
7	IO_L23P_7	F5	I/O

Table 23: FT256 Package Pinout (Continued)

Bank	XC3S200 XC3S400 XC3S1000 Pin Name	FT256 Pin Number	Type
7	IO_L24N_7	G3	I/O
7	IO_L24P_7	G4	I/O
7	IO_L39N_7	H3	I/O
7	IO_L39P_7	H4	I/O
7	IO_L40N_7/VREF_7	H1	VREF
7	IO_L40P_7	G1	I/O
7	VCCO_7	G6	VCCO
7	VCCO_7	H5	VCCO
7	VCCO_7	H6	VCCO
N/A	GND	A1	GND
N/A	GND	A16	GND
N/A	GND	B2	GND
N/A	GND	B9	GND
N/A	GND	B15	GND
N/A	GND	F6	GND
N/A	GND	F11	GND
N/A	GND	G7	GND
N/A	GND	G8	GND
N/A	GND	G9	GND
N/A	GND	G10	GND
N/A	GND	H2	GND
N/A	GND	H7	GND
N/A	GND	H8	GND
N/A	GND	H9	GND
N/A	GND	H10	GND
N/A	GND	J7	GND
N/A	GND	J8	GND
N/A	GND	J9	GND
N/A	GND	J10	GND
N/A	GND	J15	GND
N/A	GND	K7	GND
N/A	GND	K8	GND
N/A	GND	K9	GND
N/A	GND	K10	GND
N/A	GND	L6	GND
N/A	GND	L11	GND
N/A	GND	R2	GND
N/A	GND	R8	GND
N/A	GND	R15	GND
N/A	GND	T1	GND



Table 23: FT256 Package Pinout (Continued)

Bank	XC3S200 XC3S400 XC3S1000 Pin Name	FT256 Pin Number	Type
N/A	GND	T16	GND
N/A	VCCAUX	A6	VCCAUX
N/A	VCCAUX	A11	VCCAUX
N/A	VCCAUX	F1	VCCAUX
N/A	VCCAUX	F16	VCCAUX
N/A	VCCAUX	L1	VCCAUX
N/A	VCCAUX	L16	VCCAUX
N/A	VCCAUX	T6	VCCAUX
N/A	VCCAUX	T11	VCCAUX
N/A	VCCINT	D4	VCCINT
N/A	VCCINT	D13	VCCINT
N/A	VCCINT	E5	VCCINT
N/A	VCCINT	E12	VCCINT
N/A	VCCINT	M5	VCCINT
N/A	VCCINT	M12	VCCINT
N/A	VCCINT	N4	VCCINT

Table 23: FT256 Package Pinout (Continued)

Bank	XC3S200 XC3S400 XC3S1000 Pin Name	FT256 Pin Number	Type
N/A	VCCINT	N13	VCCINT
VCCAUX	CCLK	T15	CONFIG
VCCAUX	DONE	R14	CONFIG
VCCAUX	HSWAP_EN	C4	CONFIG
VCCAUX	M0	P3	CONFIG
VCCAUX	M1	T2	CONFIG
VCCAUX	M2	P4	CONFIG
VCCAUX	PROG_B	B3	CONFIG
VCCAUX	TCK	C14	JTAG
VCCAUX	TDI	A2	JTAG
VCCAUX	TDO	A15	JTAG
VCCAUX	TMS	C13	JTAG

**User I/Os by Bank**

Table 24 indicates how the available user-I/O pins are distributed between the eight I/O banks on the FT256 package.

Table 24: User I/Os Per Bank in FT256 Package

Package Edge	I/O Bank	Maximum I/O	All Possible I/O Pins by Type				
			I/O	DUAL	DCI	VREF	GCLK
Top	0	20	13	0	2	3	2
	1	20	13	0	2	3	2
Right	2	23	18	0	2	3	0
	3	23	18	0	2	3	0
Bottom	4	21	8	6	2	3	2
	5	20	7	6	2	3	2
Left	6	23	18	0	2	3	0
	7	23	18	0	2	3	0

### FT256 Footprint

		Bank 0								Bank 1							
		1	2	3	4	5	6	7	8	9	10	11	12	13	14	15	16
Bank 7	A	GND	TDI	I/O VREF_0	I/O L01P_0 VRN_0	I/O	VCCAUX	I/O	I/O L32P_0 GCLK6	I/O	I/O L31N_1 VREF_1	VCCAUX	I/O	I/O L10N_1 VREF_1	I/O L01N_1 VRP_1	TDO	GND
	B	I/O L01P_7 VRN_7	GND	PROG_B	I/O L01N_0 VRP_0	I/O L25P_0	I/O L28P_0	I/O L30P_0	I/O L32P_0 GCLK7	GND	I/O L31P_1	I/O L29N_1	I/O L27N_1	I/O L10P_1	I/O L01P_1 VRN_1	GND	I/O L01N_2 VRP_2
	C	I/O L01N_7 VRP_7	I/O L16N_7	I/O L16P_7 VREF_7	HSWAP_EN	I/O L25N_0	I/O L28N_0	I/O L30N_0	I/O L31P_0 VREF_0	I/O L32N_1 GCLK5	I/O	I/O L29P_1	I/O L27P_1	TMS	TCK	I/O L16N_2	I/O L01P_2 VRN_2
	D	I/O L17N_7	I/O L17P_7	I/O L19P_7	VCCINT	I/O VREF_0	I/O L27P_0	I/O L29P_0	I/O L31N_0	I/O L32P_1 GCLK4	I/O L30N_1	I/O L28N_1	I/O VREF_1	VCCINT	I/O L16P_2	I/O L17N_2	I/O L17P_2 VREF_2
	E	I/O L20N_7	I/O L20P_7	I/O L19N_7 VREF_7	I/O L21P_7	VCCINT	I/O L27N_0	I/O L29N_0	VCCO_0	VCCO_1	I/O L30P_1	I/O L28P_1	VCCINT	I/O L19N_2	I/O L19P_2	I/O L20N_2	I/O L20P_2
	F	VCCAUX	I/O L22N_7	I/O L22P_7	I/O L21N_7	I/O L23P_7	GND	VCCO_0	VCCO_0	VCCO_1	VCCO_1	GND	I/O L21N_2	I/O L21P_2	I/O L22N_2	I/O L22P_2	VCCAUX
	G	I/O L40P_7	I/O	I/O L24N_7	I/O L24P_7	I/O L23N_7	VCCO_7	GND	GND	GND	GND	VCCO_2	I/O L23N_2 VREF_2	I/O L23P_2	I/O L24N_2	I/O L24P_2	I/O
	H	I/O L40N_7 VREF_7	GND	I/O L39N_7	I/O L39P_7	VCCO_7	VCCO_7	GND	GND	GND	VCCO_2	VCCO_2	I/O L39N_2	I/O L39P_2	I/O L40N_2	I/O L40P_2 VREF_2	I/O
	J	I/O L40P_6 VREF_6	I/O L40N_6	I/O L39P_6	I/O L39N_6	VCCO_6	VCCO_6	GND	GND	GND	GND	VCCO_3	VCCO_3	I/O L39P_3	I/O L39N_3	GND	I/O L40N_3 VREF_3
	K	I/O	I/O L24P_6	I/O L24N_6 VREF_6	I/O L23P_6	I/O L23N_6	VCCO_6	GND	GND	GND	GND	VCCO_3	I/O L23N_3	I/O L24P_3	I/O L24N_3	I/O	I/O L40P_3
	L	VCCAUX	I/O L22P_6	I/O L22N_6	I/O L21P_6	I/O L21N_6	GND	VCCO_5	VCCO_5	VCCO_4	VCCO_4	GND	I/O L23P_3 VREF_3	I/O L21N_3	I/O L22P_3	I/O L22N_3	VCCAUX
	M	I/O L20P_6	I/O L20N_6	I/O L19P_6	I/O L19N_6	VCCINT	I/O L28P_5 D7	I/O L30P_5	VCCO_5	VCCO_4	I/O L29N_4	I/O L27N_4 DIN DO	VCCINT	I/O L21P_3	I/O L19N_3	I/O L20P_3	I/O L20N_3
	N	I/O L17P_6 VREF_6	I/O L17N_6	I/O L16P_6	VCCINT	I/O	I/O L28N_5 D6	I/O L30N_5	I/O L32P_5 GCLK2	I/O L31N_4 INIT_B	I/O L29P_4	I/O L27P_4 D1	I/O VREF_4	VCCINT	I/O L19P_3	I/O L17P_3 VREF_3	I/O L17N_3
	P	I/O L01P_6 VRN_6	I/O L16N_6	M0	M2	I/O L27P_5	I/O L29P_5 VREF_5	I/O	I/O L32N_5 GCLK3	I/O L31P_4 DOUT BUSY	I/O L30N_4 D2	I/O L28N_4	I/O L25N_4	I/O VREF_4	I/O L16P_3	I/O L16N_3	I/O L01N_3 VRP_3
	R	I/O L01N_6 VRP_6	GND	I/O L01P_5 CS_B	I/O L10P_5 VRN_5	I/O L27N_5 VREF_5	I/O L29N_5	I/O L31P_5 D5	GND	I/O L32N_4 GCLK1	I/O L30P_4 D3	I/O L28P_4	I/O L25P_4	I/O L01N_4 VRP_4	DONE	GND	I/O L01P_3 VRN_3
	T	GND	M1	I/O L01N_5 RDWR_B	I/O L10N_5 VRP_5	I/O	VCCAUX	I/O L31N_5 D4	I/O VREF_5	I/O L32P_4 GCLK0	I/O VREF_4	VCCAUX	I/O	I/O L01P_4 VRN_4	I/O	CCLK	GND
		Bank 5								Bank 4							

DS099-4\_10\_030503

Figure 11: FT256 Package Footprint (top view)

- |     |                                                    |    |                                                 |    |                                                    |
|-----|----------------------------------------------------|----|-------------------------------------------------|----|----------------------------------------------------|
| 113 | I/O: Unrestricted, general-purpose user I/O        | 12 | DUAL: Configuration pin, then possible user I/O | 24 | VREF: User I/O or input voltage reference for bank |
| 16  | DCI: User I/O or reference resistor input for bank | 8  | GCLK: User I/O or global clock buffer input     | 24 | VCCO: Output voltage supply for bank               |
| 7   | CONFIG: Dedicated configuration pins               | 4  | JTAG: Dedicated JTAG port pins                  | 8  | VCCINT: Internal core voltage supply (+1.2V)       |
| 0   | N.C.: No unconnected pins in this package          | 32 | GND: Ground                                     | 8  | VCCAUX: Auxiliary voltage supply (+2.5V)           |

## FG320: 320-lead Fine-pitch Ball Grid Array

The 320-lead fine-pitch ball grid array package, FG320, supports three different Spartan-3 devices, including the XC3S400, the XC3S1000, and the XC3S1500. The footprint for all three devices is identical, as shown in [Table 25](#) and [Figure 12](#).

The FG320 package is an 18 x 18 array of solder balls minus the four center balls.

All the package pins appear in [Table 25](#) and are sorted by bank number, then by pin name. Pairs of pins that form a differential I/O pair appear together in the table. The table also shows the pin number for each pin and the pin type, as defined earlier.

### Pinout Table

Table 25: FG320 Package Pinout

Bank	XC3S400 XC3S1000 XC3S1500 Pin Name	FG320 Pin Number	Type
0	IO	D9	I/O
0	IO	E7	I/O
0	IO/VREF_0	B3	VREF
0	IO/VREF_0	D6	VREF
0	IO_L01N_0/VRP_0	A2	DCI
0	IO_L01P_0/VRN_0	A3	DCI
0	IO_L09N_0	B4	I/O
0	IO_L09P_0	C4	I/O
0	IO_L10N_0	C5	I/O
0	IO_L10P_0	D5	I/O
0	IO_L15N_0	A4	I/O
0	IO_L15P_0	A5	I/O
0	IO_L25N_0	B5	I/O
0	IO_L25P_0	B6	I/O
0	IO_L27N_0	C7	I/O
0	IO_L27P_0	D7	I/O
0	IO_L28N_0	C8	I/O
0	IO_L28P_0	D8	I/O
0	IO_L29N_0	E8	I/O
0	IO_L29P_0	F8	I/O
0	IO_L30N_0	A7	I/O
0	IO_L30P_0	A8	I/O
0	IO_L31N_0	B9	I/O
0	IO_L31P_0/VREF_0	A9	VREF
0	IO_L32N_0/GCLK7	E9	GCLK
0	IO_L32P_0/GCLK6	F9	GCLK
0	VCCO_0	B8	VCCO

Table 25: FG320 Package Pinout (Continued)

Bank	XC3S400 XC3S1000 XC3S1500 Pin Name	FG320 Pin Number	Type
0	VCCO_0	C6	VCCO
0	VCCO_0	G8	VCCO
0	VCCO_0	G9	VCCO
1	IO	A11	I/O
1	IO	B13	I/O
1	IO	D10	I/O
1	IO/VREF_1	A12	VREF
1	IO_L01N_1/VRP_1	A16	DCI
1	IO_L01P_1/VRN_1	A17	DCI
1	IO_L10N_1/VREF_1	A15	VREF
1	IO_L10P_1	B15	I/O
1	IO_L15N_1	C14	I/O
1	IO_L15P_1	C15	I/O
1	IO_L16N_1	A14	I/O
1	IO_L16P_1	B14	I/O
1	IO_L24N_1	D14	I/O
1	IO_L24P_1	D13	I/O
1	IO_L27N_1	E13	I/O
1	IO_L27P_1	E12	I/O
1	IO_L28N_1	C12	I/O
1	IO_L28P_1	D12	I/O
1	IO_L29N_1	F11	I/O
1	IO_L29P_1	E11	I/O
1	IO_L30N_1	C11	I/O
1	IO_L30P_1	D11	I/O
1	IO_L31N_1/VREF_1	A10	VREF
1	IO_L31P_1	B10	I/O
1	IO_L32N_1/GCLK5	E10	GCLK
1	IO_L32P_1/GCLK4	F10	GCLK
1	VCCO_1	B11	VCCO
1	VCCO_1	C13	VCCO
1	VCCO_1	G10	VCCO
1	VCCO_1	G11	VCCO
2	IO	J13	I/O
2	IO_L01N_2/VRP_2	C16	DCI
2	IO_L01P_2/VRN_2	C17	DCI
2	IO_L16N_2	B18	I/O
2	IO_L16P_2	C18	I/O
2	IO_L17N_2	D17	I/O
2	IO_L17P_2/VREF_2	D18	VREF
2	IO_L19N_2	D16	I/O
2	IO_L19P_2	E16	I/O

Table 25: FG320 Package Pinout (Continued)

Bank	XC3S400 XC3S1000 XC3S1500 Pin Name	FG320 Pin Number	Type
2	IO_L20N_2	E17	I/O
2	IO_L20P_2	E18	I/O
2	IO_L21N_2	F15	I/O
2	IO_L21P_2	E15	I/O
2	IO_L22N_2	F14	I/O
2	IO_L22P_2	G14	I/O
2	IO_L23N_2/VREF_2	G18	VREF
2	IO_L23P_2	F17	I/O
2	IO_L24N_2	G15	I/O
2	IO_L24P_2	G16	I/O
2	IO_L27N_2	H13	I/O
2	IO_L27P_2	H14	I/O
2	IO_L34N_2/VREF_2	H16	VREF
2	IO_L34P_2	H15	I/O
2	IO_L35N_2	H17	I/O
2	IO_L35P_2	H18	I/O
2	IO_L39N_2	J18	I/O
2	IO_L39P_2	J17	I/O
2	IO_L40N_2	J15	I/O
2	IO_L40P_2/VREF_2	J14	VREF
2	VCCO_2	F16	VCCO
2	VCCO_2	H12	VCCO
2	VCCO_2	J12	VCCO
3	IO	K15	I/O
3	IO_L01N_3/VRP_3	T17	DCI
3	IO_L01P_3/VRN_3	T16	DCI
3	IO_L16N_3	T18	I/O
3	IO_L16P_3	U18	I/O
3	IO_L17N_3	P16	I/O
3	IO_L17P_3/VREF_3	R16	VREF
3	IO_L19N_3	R17	I/O
3	IO_L19P_3	R18	I/O
3	IO_L20N_3	P18	I/O
3	IO_L20P_3	P17	I/O
3	IO_L21N_3	P15	I/O
3	IO_L21P_3	N15	I/O
3	IO_L22N_3	M14	I/O
3	IO_L22P_3	N14	I/O
3	IO_L23N_3	M15	I/O
3	IO_L23P_3/VREF_3	M16	VREF
3	IO_L24N_3	M18	I/O
3	IO_L24P_3	N17	I/O

Table 25: FG320 Package Pinout (Continued)

Bank	XC3S400 XC3S1000 XC3S1500 Pin Name	FG320 Pin Number	Type
3	IO_L27N_3	L14	I/O
3	IO_L27P_3	L13	I/O
3	IO_L34N_3	L15	I/O
3	IO_L34P_3/VREF_3	L16	VREF
3	IO_L35N_3	L18	I/O
3	IO_L35P_3	L17	I/O
3	IO_L39N_3	K13	I/O
3	IO_L39P_3	K14	I/O
3	IO_L40N_3/VREF_3	K17	VREF
3	IO_L40P_3	K18	I/O
3	VCCO_3	K12	VCCO
3	VCCO_3	L12	VCCO
3	VCCO_3	N16	VCCO
4	IO	P12	I/O
4	IO	V14	I/O
4	IO/VREF_4	R10	VREF
4	IO/VREF_4	U13	VREF
4	IO/VREF_4	V17	VREF
4	IO_L01N_4/VRP_4	U16	DCI
4	IO_L01P_4/VRN_4	V16	DCI
4	IO_L06N_4/VREF_4	P14	VREF
4	IO_L06P_4	R14	I/O
4	IO_L09N_4	U15	I/O
4	IO_L09P_4	V15	I/O
4	IO_L10N_4	T14	I/O
4	IO_L10P_4	U14	I/O
4	IO_L25N_4	R13	I/O
4	IO_L25P_4	P13	I/O
4	IO_L27N_4/DIN/D0	T12	DUAL
4	IO_L27P_4/D1	R12	DUAL
4	IO_L28N_4	V12	I/O
4	IO_L28P_4	V11	I/O
4	IO_L29N_4	R11	I/O
4	IO_L29P_4	T11	I/O
4	IO_L30N_4/D2	N11	DUAL
4	IO_L30P_4/D3	P11	DUAL
4	IO_L31N_4/INIT_B	U10	DUAL
4	IO_L31P_4/ DOUT/BUSY	V10	DUAL
4	IO_L32N_4/GCLK1	N10	GCLK
4	IO_L32P_4/GCLK0	P10	GCLK
4	VCCO_4	M10	VCCO

Table 25: FG320 Package Pinout (Continued)

Bank	XC3S400 XC3S1000 XC3S1500 Pin Name	FG320 Pin Number	Type
4	VCCO_4	M11	VCCO
4	VCCO_4	T13	VCCO
4	VCCO_4	U11	VCCO
5	IO	N8	I/O
5	IO	P8	I/O
5	IO	U6	I/O
5	IO/VREF_5	R9	VREF
5	IO_L01N_5/RDWR_B	V3	DUAL
5	IO_L01P_5/CS_B	V2	DUAL
5	IO_L06N_5	T5	I/O
5	IO_L06P_5	T4	I/O
5	IO_L10N_5/VRP_5	V4	DCI
5	IO_L10P_5/VRN_5	U4	DCI
5	IO_L15N_5	R6	I/O
5	IO_L15P_5	R5	I/O
5	IO_L16N_5	V5	I/O
5	IO_L16P_5	U5	I/O
5	IO_L27N_5/VREF_5	P6	VREF
5	IO_L27P_5	P7	I/O
5	IO_L28N_5/D6	R7	DUAL
5	IO_L28P_5/D7	T7	DUAL
5	IO_L29N_5	V8	I/O
5	IO_L29P_5/VREF_5	V7	VREF
5	IO_L30N_5	R8	I/O
5	IO_L30P_5	T8	I/O
5	IO_L31N_5/D4	U9	DUAL
5	IO_L31P_5/D5	V9	DUAL
5	IO_L32N_5/GCLK3	N9	GCLK
5	IO_L32P_5/GCLK2	P9	GCLK
5	VCCO_5	M8	VCCO
5	VCCO_5	M9	VCCO
5	VCCO_5	T6	VCCO
5	VCCO_5	U8	VCCO
6	IO	K6	I/O
6	IO_L01N_6/VRP_6	T3	DCI
6	IO_L01P_6/VRN_6	T2	DCI
6	IO_L16N_6	U1	I/O
6	IO_L16P_6	T1	I/O
6	IO_L17N_6	R2	I/O
6	IO_L17P_6/VREF_6	R1	VREF
6	IO_L19N_6	R3	I/O
6	IO_L19P_6	P3	I/O

Table 25: FG320 Package Pinout (Continued)

Bank	XC3S400 XC3S1000 XC3S1500 Pin Name	FG320 Pin Number	Type
6	IO_L20N_6	P2	I/O
6	IO_L20P_6	P1	I/O
6	IO_L21N_6	N4	I/O
6	IO_L21P_6	P4	I/O
6	IO_L22N_6	N5	I/O
6	IO_L22P_6	M5	I/O
6	IO_L23N_6	M3	I/O
6	IO_L23P_6	M4	I/O
6	IO_L24N_6/VREF_6	N2	VREF
6	IO_L24P_6	M1	I/O
6	IO_L27N_6	L6	I/O
6	IO_L27P_6	L5	I/O
6	IO_L34N_6/VREF_6	L3	VREF
6	IO_L34P_6	L4	I/O
6	IO_L35N_6	L2	I/O
6	IO_L35P_6	L1	I/O
6	IO_L39N_6	K5	I/O
6	IO_L39P_6	K4	I/O
6	IO_L40N_6	K1	I/O
6	IO_L40P_6/VREF_6	K2	VREF
6	VCCO_6	K7	VCCO
6	VCCO_6	L7	VCCO
6	VCCO_6	N3	VCCO
7	IO	J6	I/O
7	IO_L01N_7/VRP_7	C3	DCI
7	IO_L01P_7/VRN_7	C2	DCI
7	IO_L16N_7	C1	I/O
7	IO_L16P_7/VREF_7	B1	VREF
7	IO_L17N_7	D1	I/O
7	IO_L17P_7	D2	I/O
7	IO_L19N_7/VREF_7	E3	VREF
7	IO_L19P_7	D3	I/O
7	IO_L20N_7	E2	I/O
7	IO_L20P_7	E1	I/O
7	IO_L21N_7	E4	I/O
7	IO_L21P_7	F4	I/O
7	IO_L22N_7	G5	I/O
7	IO_L22P_7	F5	I/O
7	IO_L23N_7	G1	I/O
7	IO_L23P_7	F2	I/O
7	IO_L24N_7	G4	I/O
7	IO_L24P_7	G3	I/O

Table 25: FG320 Package Pinout (Continued)

Bank	XC3S400 XC3S1000 XC3S1500 Pin Name	FG320 Pin Number	Type
7	IO_L27N_7	H5	I/O
7	IO_L27P_7/VREF_7	H6	VREF
7	IO_L34N_7	H4	I/O
7	IO_L34P_7	H3	I/O
7	IO_L35N_7	H1	I/O
7	IO_L35P_7	H2	I/O
7	IO_L39N_7	J1	I/O
7	IO_L39P_7	J2	I/O
7	IO_L40N_7/VREF_7	J5	VREF
7	IO_L40P_7	J4	I/O
7	VCCO_7	F3	VCCO
7	VCCO_7	H7	VCCO
7	VCCO_7	J7	VCCO
N/A	GND	A1	GND
N/A	GND	A13	GND
N/A	GND	A18	GND
N/A	GND	A6	GND
N/A	GND	B17	GND
N/A	GND	B2	GND
N/A	GND	C10	GND
N/A	GND	C9	GND
N/A	GND	F1	GND
N/A	GND	F18	GND
N/A	GND	G12	GND
N/A	GND	G7	GND
N/A	GND	H10	GND
N/A	GND	H11	GND
N/A	GND	H8	GND
N/A	GND	H9	GND
N/A	GND	J11	GND
N/A	GND	J16	GND
N/A	GND	J3	GND
N/A	GND	J8	GND
N/A	GND	K11	GND
N/A	GND	K16	GND
N/A	GND	K3	GND
N/A	GND	K8	GND
N/A	GND	L10	GND
N/A	GND	L11	GND
N/A	GND	L8	GND
N/A	GND	L9	GND
N/A	GND	M12	GND

Table 25: FG320 Package Pinout (Continued)

Bank	XC3S400 XC3S1000 XC3S1500 Pin Name	FG320 Pin Number	Type
N/A	GND	M7	GND
N/A	GND	N1	GND
N/A	GND	N18	GND
N/A	GND	T10	GND
N/A	GND	T9	GND
N/A	GND	U17	GND
N/A	GND	U2	GND
N/A	GND	V1	GND
N/A	GND	V13	GND
N/A	GND	V18	GND
N/A	GND	V6	GND
N/A	VCCAUX	B12	VCCAUX
N/A	VCCAUX	B7	VCCAUX
N/A	VCCAUX	G17	VCCAUX
N/A	VCCAUX	G2	VCCAUX
N/A	VCCAUX	M17	VCCAUX
N/A	VCCAUX	M2	VCCAUX
N/A	VCCAUX	U12	VCCAUX
N/A	VCCAUX	U7	VCCAUX
N/A	VCCINT	F12	VCCINT
N/A	VCCINT	F13	VCCINT
N/A	VCCINT	F6	VCCINT
N/A	VCCINT	F7	VCCINT
N/A	VCCINT	G13	VCCINT
N/A	VCCINT	G6	VCCINT
N/A	VCCINT	M13	VCCINT
N/A	VCCINT	M6	VCCINT
N/A	VCCINT	N12	VCCINT
N/A	VCCINT	N13	VCCINT
N/A	VCCINT	N6	VCCINT
N/A	VCCINT	N7	VCCINT
VCCAUX	CCLK	T15	CONFIG
VCCAUX	DONE	R15	CONFIG
VCCAUX	HSWAP_EN	E6	CONFIG
VCCAUX	M0	P5	CONFIG
VCCAUX	M1	U3	CONFIG
VCCAUX	M2	R4	CONFIG
VCCAUX	PROG_B	E5	CONFIG
VCCAUX	TCK	E14	JTAG
VCCAUX	TDI	D4	JTAG
VCCAUX	TDO	D15	JTAG
VCCAUX	TMS	B16	JTAG

## User I/Os by Bank

Table 26 indicates how the available user-I/O pins are distributed between the eight I/O banks on the FG320 package.

Table 26: User I/Os Per Bank in FG320 Package

Package Edge	I/O Bank	Maximum I/O	Maximum LVDS Pairs	All Possible I/O Pins by Type				
				I/O	DUAL	DCI	VREF	GCLK
Top	0	26	11	19	0	2	3	2
	1	26	11	19	0	2	3	2
Right	2	29	14	23	0	2	4	0
	3	29	14	23	0	2	4	0
Bottom	4	27	11	13	6	2	4	2
	5	26	11	13	6	2	3	2
Left	6	29	14	23	0	2	4	0
	7	29	14	23	0	2	4	0

### FG320 Footprint

		Bank 0										Bank 1							
		1	2	3	4	5	6	7	8	9	10	11	12	13	14	15	16	17	18
Bank 7	A	GND	I/O L01N_0 VREF_0	I/O L01P_0 VRN_0	I/O L15N_0	I/O L15P_0	GND	I/O L30N_0	I/O L30P_0	I/O L31P_0 VREF_0	I/O L31N_1 VREF_1	I/O	I/O VREF_1	GND	I/O L16N_1	I/O L10N_1 VREF_1	I/O L01N_1 VREF_1	I/O L01P_1 VRN_1	GND
	B	I/O L16P_7 VREF_7	GND	I/O VREF_0	I/O L09N_0	I/O L25N_0	I/O L25P_0	VCCAUX	VCCO_0	I/O L31N_0	I/O L31P_1	VCCO_1	VCCAUX	I/O	I/O L16P_1	I/O L10P_1	TMS	GND	I/O L16N_2
	C	I/O L16N_7	I/O L01P_7 VRN_7	I/O L01N_7 VREF_7	I/O L09P_0	I/O L10N_0	VCCO_0	I/O L27N_0	I/O L28N_0	GND	GND	I/O L30N_1	I/O L28N_1	VCCO_1	I/O L15N_1	I/O L15P_1	I/O L01N_2 VREF_2	I/O L01P_2 VRN_2	I/O L16P_2
	D	I/O L17N_7	I/O L17P_7	I/O L19P_7	TDI	I/O L10P_0	I/O VREF_0	I/O L27P_0	I/O L28P_0	I/O	I/O	I/O L30P_1	I/O L28P_1	I/O L24P_1	I/O L24N_1	TDO	I/O L19N_2	I/O L17N_2	I/O L17P_2 VREF_2
	E	I/O L20P_7	I/O L20N_7	I/O L19N_7 VREF_7	I/O L21N_7	PROG_B	HSWAP_EN	I/O	I/O L29N_0	I/O L32N_0 GCLK7	I/O L32N_1 GCLK5	I/O L29P_1	I/O L27P_1	I/O L27N_1	TCK	I/O L21P_2	I/O L19P_2	I/O L20N_2	I/O L20P_2
	F	GND	I/O L23P_7	VCCO_7	I/O L21P_7	I/O L22P_7	VCCINT	VCCINT	I/O L29P_0	I/O L32P_0 GCLK6	I/O L32P_1 GCLK4	I/O L29N_1	VCCINT	VCCINT	I/O L22N_2	I/O L21N_2	VCCO_2	I/O L23P_2	GND
	G	I/O L23N_7	VCCAUX	I/O L24P_7	I/O L24N_7	I/O L22N_7	VCCINT	GND	VCCO_0	VCCO_0	VCCO_1	VCCO_1	GND	VCCINT	I/O L22P_2	I/O L24N_2	I/O L24P_2	VCCAUX	I/O L23N_2 VREF_2
	H	I/O L35N_7	I/O L35P_7	I/O L34P_7	I/O L34N_7	I/O L27N_7	I/O L27P_7 VREF_7	VCCO_7	GND	GND	GND	GND	VCCO_2	I/O L27N_2	I/O L27P_2	I/O L34P_2	I/O L34N_2 VREF_2	I/O L35N_2	I/O L35P_2
	J	I/O L39N_7	I/O L39P_7	GND	I/O L40P_7	I/O L40N_7 VREF_7	I/O	VCCO_7	GND			GND	VCCO_2	I/O	I/O L40P_2 VREF_2	I/O L40N_2	GND	I/O L39P_2	I/O L39N_2
	K	I/O L40N_6	I/O L40P_6 VREF_6	GND	I/O L39P_6	I/O L39N_6	I/O	VCCO_6	GND			GND	VCCO_3	I/O L39N_3	I/O L39P_3	I/O	GND	I/O L40N_3 VREF_3	I/O L40P_3
	L	I/O L35P_6	I/O L35N_6	I/O L34N_6 VREF_6	I/O L34P_6	I/O L27P_6	I/O L27N_6	VCCO_6	GND	GND	GND	GND	VCCO_3	I/O L27P_3	I/O L27N_3	I/O L34N_3	I/O L34P_3 VREF_3	I/O L35P_3	I/O L35N_3
	M	I/O L24P_6	VCCAUX	I/O L23N_6	I/O L23P_6	I/O L22P_6	VCCINT	GND	VCCO_5	VCCO_5	VCCO_4	VCCO_4	GND	VCCINT	I/O L22N_3	I/O L23N_3	I/O L23P_3 VREF_3	VCCAUX	I/O L24N_3
	N	GND	I/O L24N_6 VREF_6	VCCO_6	I/O L21N_6	I/O L22N_6	VCCINT	VCCINT	I/O	I/O L32N_4 GCLK3	I/O L32N_4 GCLK1	I/O L30N_4 D2	VCCINT	VCCINT	I/O L22P_3	I/O L21P_3	VCCO_3	I/O L24P_3	GND
	P	I/O L20P_6	I/O L20N_6	I/O L19P_6	I/O L21P_6	M0	I/O L27N_5 VREF_5	I/O L27P_5	I/O	I/O L32P_5 GCLK2	I/O L32P_4 GCLK0	I/O L30P_4 D3	I/O	I/O L25P_4	I/O L06N_4 VREF_4	I/O L21N_3	I/O L17N_3	I/O L20P_3	I/O L20N_3
	R	I/O L17P_6 VREF_6	I/O L17N_6	I/O L19N_6	M2	I/O L15P_5	I/O L15N_5	I/O L28N_5 D6	I/O L30N_5	I/O VREF_5	I/O VREF_4	I/O L29N_4	I/O L27P_4 D1	I/O L25N_4	I/O L06P_4	DONE	I/O L17P_3 VREF_3	I/O L19N_3	I/O L19P_3
	T	I/O L16P_6	I/O L01P_6 VRN_6	I/O L01N_6 VREF_6	I/O L06P_5	I/O L06N_5	VCCO_5	I/O L28P_5 D7	I/O L30P_5	GND	GND	I/O L29P_4	I/O L27N_4 DIN D0	VCCO_4	I/O L10N_4	CCLK	I/O L01P_3 VRN_3	I/O L01N_3 VREF_3	I/O L16N_3
	U	I/O L16N_6	GND	M1	I/O L10P_5 VRN_5	I/O L16P_5	I/O	VCCAUX	VCCO_5	I/O L31N_5 D4	I/O L31N_4 INIT_B	VCCO_4	VCCAUX	I/O VREF_4	I/O L10P_4	I/O L09N_4	I/O L01N_4 VREF_4	GND	I/O L16P_3
	V	GND	I/O L01P_5 CS_B	I/O L01N_5 RDWR_B	I/O L10N_5 VREF_5	I/O L16N_5	GND	I/O L29P_5 VREF_5	I/O L29N_5	I/O L31P_5 D5	I/O L31P_4 DOUT BUSY	I/O L28P_4	I/O L28N_4	GND	I/O	I/O L09P_4	I/O L01P_4 VRN_4	I/O VREF_4	GND
		Bank 5										Bank 4							

ds099-3\_16\_121103

Figure 12: FG320 Package Footprint (top view)

<b>156</b> I/O: Unrestricted, general-purpose user I/O	<b>12</b> DUAL: Configuration pin, then possible user I/O	<b>29</b> VREF: User I/O or input voltage reference for bank
<b>16</b> DCI: User I/O or reference resistor input for bank	<b>8</b> GCLK: User I/O or global clock buffer input	<b>28</b> VCCO: Output voltage supply for bank
<b>7</b> CONFIG: Dedicated configuration pins	<b>4</b> JTAG: Dedicated JTAG port pins	<b>12</b> VCCINT: Internal core voltage supply (+1.2V)
<b>0</b> N.C.: No unconnected pins in this package	<b>40</b> GND: Ground	<b>8</b> VCCAUX: Auxiliary voltage supply (+2.5V)



## FG456: 456-lead Fine-pitch Ball Grid Array

The 456-lead fine-pitch ball grid array package, FG456, supports three different Spartan-3 devices, including the XC3S400, the XC3S1000, and the XC3S1500. The footprints for the XC3S1000 and XC3S1500 are identical, as shown in [Table 27](#) and [Figure 13](#). The XC3S400, however, has fewer I/O pins which consequently results in 69 unconnected pins on the FG456 package, labeled as “N.C.” In [Table 27](#) and [Figure 13](#), these unconnected pins are indicated with a black diamond symbol (◆).

All the package pins appear in [Table 27](#) and are sorted by bank number, then by pin name. Pairs of pins that form a differential I/O pair appear together in the table. The table also shows the pin number for each pin and the pin type, as defined earlier.

If there is a difference between the XC3S400 pinout and the pinout for the XC3S1000 and XC3S1500, then that difference is highlighted in [Table 27](#). If the table entry is shaded grey, then there is an unconnected pin on the XC3S400 that maps to a user-I/O pin on the XC3S1000 and XC3S1500. If the table entry is shaded tan, then the unconnected pin on the XC3S400 maps to a VREF-type pin on the XC3S1000 and XC3S1500. If the other VREF pins in the bank all connect to a voltage reference to support a special I/O standard, then also connect the N.C. pin on the XC3S400 to the same VREF voltage. This provides maximum flexibility as you could potentially migrate a design from the XC3S400 device to an XC3S1000 or XC3S1500 FPGA without changing the printed circuit board.

### Pinout Table

Table 27: FG456 Package Pinout

Bank	3S400 Pin Name	3S1000 3S1500 Pin Name	FG456 Pin Number	Type
0	IO	IO	A10	I/O
0	IO	IO	D9	I/O
0	IO	IO	D10	I/O
0	IO	IO	F6	I/O
0	IO/VREF_0	IO/VREF_0	A3	VREF
0	IO/VREF_0	IO/VREF_0	C7	VREF
0	N.C. (◆)	IO/VREF_0	E5	VREF
0	IO/VREF_0	IO/VREF_0	F7	VREF
0	IO_L01N_0/ VRP_0	IO_L01N_0/ VRP_0	B4	DCI
0	IO_L01P_0/ VRN_0	IO_L01P_0/ VRN_0	A4	DCI
0	IO_L06N_0	IO_L06N_0	D5	I/O
0	IO_L06P_0	IO_L06P_0	C5	I/O
0	IO_L09N_0	IO_L09N_0	B5	I/O
0	IO_L09P_0	IO_L09P_0	A5	I/O

Table 27: FG456 Package Pinout (Continued)

Bank	3S400 Pin Name	3S1000 3S1500 Pin Name	FG456 Pin Number	Type
0	IO_L10N_0	IO_L10N_0	E6	I/O
0	IO_L10P_0	IO_L10P_0	D6	I/O
0	IO_L15N_0	IO_L15N_0	C6	I/O
0	IO_L15P_0	IO_L15P_0	B6	I/O
0	IO_L16N_0	IO_L16N_0	E7	I/O
0	IO_L16P_0	IO_L16P_0	D7	I/O
0	N.C. (◆)	IO_L19N_0	B7	I/O
0	N.C. (◆)	IO_L19P_0	A7	I/O
0	N.C. (◆)	IO_L22N_0	E8	I/O
0	N.C. (◆)	IO_L22P_0	D8	I/O
0	IO_L24N_0	IO_L24N_0	B8	I/O
0	IO_L24P_0	IO_L24P_0	A8	I/O
0	IO_L25N_0	IO_L25N_0	F9	I/O
0	IO_L25P_0	IO_L25P_0	E9	I/O
0	IO_L27N_0	IO_L27N_0	B9	I/O
0	IO_L27P_0	IO_L27P_0	A9	I/O
0	IO_L28N_0	IO_L28N_0	F10	I/O
0	IO_L28P_0	IO_L28P_0	E10	I/O
0	IO_L29N_0	IO_L29N_0	C10	I/O
0	IO_L29P_0	IO_L29P_0	B10	I/O
0	IO_L30N_0	IO_L30N_0	F11	I/O
0	IO_L30P_0	IO_L30P_0	E11	I/O
0	IO_L31N_0	IO_L31N_0	D11	I/O
0	IO_L31P_0/ VREF_0	IO_L31P_0/ VREF_0	C11	VREF
0	IO_L32N_0/ GCLK7	IO_L32N_0/ GCLK7	B11	GCLK
0	IO_L32P_0/ GCLK6	IO_L32P_0/ GCLK6	A11	GCLK
0	VCCO_0	VCCO_0	C8	VCCO
0	VCCO_0	VCCO_0	F8	VCCO
0	VCCO_0	VCCO_0	G9	VCCO
0	VCCO_0	VCCO_0	G10	VCCO
0	VCCO_0	VCCO_0	G11	VCCO
1	IO	IO	A12	I/O
1	IO	IO	E16	I/O
1	IO	IO	F12	I/O
1	IO	IO	F13	I/O
1	IO	IO	F16	I/O
1	IO	IO	F17	I/O
1	IO/VREF_1	IO/VREF_1	E13	VREF
1	N.C. (◆)	IO/VREF_1	F14	VREF
1	IO_L01N_1/ VRP_1	IO_L01N_1/ VRP_1	C19	DCI
1	IO_L01P_1/ VRN_1	IO_L01P_1/ VRN_1	B20	DCI

Table 27: FG456 Package Pinout (Continued)

Bank	3S400 Pin Name	3S1000 3S1500 Pin Name	FG456 Pin Number	Type
1	IO_L06N_1/ VREF_1	IO_L06N_1/ VREF_1	A19	VREF
1	IO_L06P_1	IO_L06P_1	B19	I/O
1	IO_L09N_1	IO_L09N_1	C18	I/O
1	IO_L09P_1	IO_L09P_1	D18	I/O
1	IO_L10N_1/ VREF_1	IO_L10N_1/ VREF_1	A18	VREF
1	IO_L10P_1	IO_L10P_1	B18	I/O
1	IO_L15N_1	IO_L15N_1	D17	I/O
1	IO_L15P_1	IO_L15P_1	E17	I/O
1	IO_L16N_1	IO_L16N_1	B17	I/O
1	IO_L16P_1	IO_L16P_1	C17	I/O
1	N.C. (◆)	IO_L19N_1	C16	I/O
1	N.C. (◆)	IO_L19P_1	D16	I/O
1	N.C. (◆)	IO_L22N_1	A16	I/O
1	N.C. (◆)	IO_L22P_1	B16	I/O
1	IO_L24N_1	IO_L24N_1	D15	I/O
1	IO_L24P_1	IO_L24P_1	E15	I/O
1	IO_L25N_1	IO_L25N_1	B15	I/O
1	IO_L25P_1	IO_L25P_1	A15	I/O
1	IO_L27N_1	IO_L27N_1	D14	I/O
1	IO_L27P_1	IO_L27P_1	E14	I/O
1	IO_L28N_1	IO_L28N_1	A14	I/O
1	IO_L28P_1	IO_L28P_1	B14	I/O
1	IO_L29N_1	IO_L29N_1	C13	I/O
1	IO_L29P_1	IO_L29P_1	D13	I/O
1	IO_L30N_1	IO_L30N_1	A13	I/O
1	IO_L30P_1	IO_L30P_1	B13	I/O
1	IO_L31N_1/ VREF_1	IO_L31N_1/ VREF_1	D12	VREF
1	IO_L31P_1	IO_L31P_1	E12	I/O
1	IO_L32N_1/ GCLK5	IO_L32N_1/ GCLK5	B12	GCLK
1	IO_L32P_1/ GCLK4	IO_L32P_1/ GCLK4	C12	GCLK
1	VCCO_1	VCCO_1	C15	VCCO
1	VCCO_1	VCCO_1	F15	VCCO
1	VCCO_1	VCCO_1	G12	VCCO
1	VCCO_1	VCCO_1	G13	VCCO
1	VCCO_1	VCCO_1	G14	VCCO
2	IO	IO	C22	I/O
2	IO_L01N_2/ VRP_2	IO_L01N_2/ VRP_2	C20	DCI
2	IO_L01P_2/ VRN_2	IO_L01P_2/ VRN_2	C21	DCI
2	IO_L16N_2	IO_L16N_2	D20	I/O

Table 27: FG456 Package Pinout (Continued)

Bank	3S400 Pin Name	3S1000 3S1500 Pin Name	FG456 Pin Number	Type
2	IO_L16P_2	IO_L16P_2	D19	I/O
2	IO_L17N_2	IO_L17N_2	D21	I/O
2	IO_L17P_2 /VREF_2	IO_L17P_2/ VREF_2	D22	VREF
2	IO_L19N_2	IO_L19N_2	E18	I/O
2	IO_L19P_2	IO_L19P_2	F18	I/O
2	IO_L20N_2	IO_L20N_2	E19	I/O
2	IO_L20P_2	IO_L20P_2	E20	I/O
2	IO_L21N_2	IO_L21N_2	E21	I/O
2	IO_L21P_2	IO_L21P_2	E22	I/O
2	IO_L22N_2	IO_L22N_2	G17	I/O
2	IO_L22P_2	IO_L22P_2	G18	I/O
2	IO_L23N_2 /VREF_2	IO_L23N_2/ VREF_2	F19	VREF
2	IO_L23P_2	IO_L23P_2	G19	I/O
2	IO_L24N_2	IO_L24N_2	F20	I/O
2	IO_L24P_2	IO_L24P_2	F21	I/O
2	N.C. (◆)	IO_L26N_2	G20	I/O
2	N.C. (◆)	IO_L26P_2	H19	I/O
2	IO_L27N_2	IO_L27N_2	G21	I/O
2	IO_L27P_2	IO_L27P_2	G22	I/O
2	N.C. (◆)	IO_L28N_2	H18	I/O
2	N.C. (◆)	IO_L28P_2	J17	I/O
2	N.C. (◆)	IO_L29N_2	H21	I/O
2	N.C. (◆)	IO_L29P_2	H22	I/O
2	N.C. (◆)	IO_L31N_2	J18	I/O
2	N.C. (◆)	IO_L31P_2	J19	I/O
2	N.C. (◆)	IO_L32N_2	J21	I/O
2	N.C. (◆)	IO_L32P_2	J22	I/O
2	N.C. (◆)	IO_L33N_2	K17	I/O
2	N.C. (◆)	IO_L33P_2	K18	I/O
2	IO_L34N_2/ VREF_2	IO_L34N_2/ VREF_2	K19	VREF
2	IO_L34P_2	IO_L34P_2	K20	I/O
2	IO_L35N_2	IO_L35N_2	K21	I/O
2	IO_L35P_2	IO_L35P_2	K22	I/O
2	IO_L38N_2	IO_L38N_2	L17	I/O
2	IO_L38P_2	IO_L38P_2	L18	I/O
2	IO_L39N_2	IO_L39N_2	L19	I/O
2	IO_L39P_2	IO_L39P_2	L20	I/O
2	IO_L40N_2	IO_L40N_2	L21	I/O
2	IO_L40P_2/ VREF_2	IO_L40P_2/ VREF_2	L22	VREF
2	VCCO_2	VCCO_2	H17	VCCO
2	VCCO_2	VCCO_2	H20	VCCO

Table 27: FG456 Package Pinout (Continued)

Bank	3S400 Pin Name	3S1000 3S1500 Pin Name	FG456 Pin Number	Type
2	VCCO_2	VCCO_2	J16	VCCO
2	VCCO_2	VCCO_2	K16	VCCO
2	VCCO_2	VCCO_2	L16	VCCO
3	IO	IO	Y21	I/O
3	IO_L01N_3/ VRP_3	IO_L01N_3/ VRP_3	Y20	DCI
3	IO_L01P_3/ VRN_3	IO_L01P_3/ VRN_3	Y19	DCI
3	IO_L16N_3	IO_L16N_3	W22	I/O
3	IO_L16P_3	IO_L16P_3	Y22	I/O
3	IO_L17N_3	IO_L17N_3	V19	I/O
3	IO_L17P_3/ VREF_3	IO_L17P_3/ VREF_3	W19	VREF
3	IO_L19N_3	IO_L19N_3	W21	I/O
3	IO_L19P_3	IO_L19P_3	W20	I/O
3	IO_L20N_3	IO_L20N_3	U19	I/O
3	IO_L20P_3	IO_L20P_3	V20	I/O
3	IO_L21N_3	IO_L21N_3	V22	I/O
3	IO_L21P_3	IO_L21P_3	V21	I/O
3	IO_L22N_3	IO_L22N_3	T17	I/O
3	IO_L22P_3	IO_L22P_3	U18	I/O
3	IO_L23N_3	IO_L23N_3	U21	I/O
3	IO_L23P_3/ VREF_3	IO_L23P_3/ VREF_3	U20	VREF
3	IO_L24N_3	IO_L24N_3	R18	I/O
3	IO_L24P_3	IO_L24P_3	T18	I/O
3	N.C. (◆)	IO_L26N_3	T20	I/O
3	N.C. (◆)	IO_L26P_3	T19	I/O
3	IO_L27N_3	IO_L27N_3	T22	I/O
3	IO_L27P_3	IO_L27P_3	T21	I/O
3	N.C. (◆)	IO_L28N_3	R22	I/O
3	N.C. (◆)	IO_L28P_3	R21	I/O
3	N.C. (◆)	IO_L29N_3	P19	I/O
3	N.C. (◆)	IO_L29P_3	R19	I/O
3	N.C. (◆)	IO_L31N_3	P18	I/O
3	N.C. (◆)	IO_L31P_3	P17	I/O
3	N.C. (◆)	IO_L32N_3	P22	I/O
3	N.C. (◆)	IO_L32P_3	P21	I/O
3	N.C. (◆)	IO_L33N_3	N18	I/O
3	N.C. (◆)	IO_L33P_3	N17	I/O
3	IO_L34N_3	IO_L34N_3	N20	I/O
3	IO_L34P_3/ VREF_3	IO_L34P_3/ VREF_3	N19	VREF
3	IO_L35N_3	IO_L35N_3	N22	I/O
3	IO_L35P_3	IO_L35P_3	N21	I/O
3	IO_L38N_3	IO_L38N_3	M18	I/O

Table 27: FG456 Package Pinout (Continued)

Bank	3S400 Pin Name	3S1000 3S1500 Pin Name	FG456 Pin Number	Type
3	IO_L38P_3	IO_L38P_3	M17	I/O
3	IO_L39N_3	IO_L39N_3	M20	I/O
3	IO_L39P_3	IO_L39P_3	M19	I/O
3	IO_L40N_3/ VREF_3	IO_L40N_3/ VREF_3	M22	VREF
3	IO_L40P_3	IO_L40P_3	M21	I/O
3	VCCO_3	VCCO_3	M16	VCCO
3	VCCO_3	VCCO_3	N16	VCCO
3	VCCO_3	VCCO_3	P16	VCCO
3	VCCO_3	VCCO_3	R17	VCCO
3	VCCO_3	VCCO_3	R20	VCCO
4	IO	IO	U16	I/O
4	IO	IO	U17	I/O
4	IO	IO	W13	I/O
4	IO	IO	W14	I/O
4	IO/VREF_4	IO/VREF_4	AB13	VREF
4	IO/VREF_4	IO/VREF_4	V18	VREF
4	IO/VREF_4	IO/VREF_4	Y16	VREF
4	IO_L01N_4/ VRP_4	IO_L01N_4/ VRP_4	AA20	DCI
4	IO_L01P_4/ VRN_4	IO_L01P_4/ VRN_4	AB20	DCI
4	N.C. (◆)	IO_L05N_4	AA19	I/O
4	N.C. (◆)	IO_L05P_4	AB19	I/O
4	IO_L06N_4/ VREF_4	IO_L06N_4/ VREF_4	W18	VREF
4	IO_L06P_4	IO_L06P_4	Y18	I/O
4	IO_L09N_4	IO_L09N_4	AA18	I/O
4	IO_L09P_4	IO_L09P_4	AB18	I/O
4	IO_L10N_4	IO_L10N_4	V17	I/O
4	IO_L10P_4	IO_L10P_4	W17	I/O
4	IO_L15N_4	IO_L15N_4	Y17	I/O
4	IO_L15P_4	IO_L15P_4	AA17	I/O
4	IO_L16N_4	IO_L16N_4	V16	I/O
4	IO_L16P_4	IO_L16P_4	W16	I/O
4	N.C. (◆)	IO_L19N_4	AA16	I/O
4	N.C. (◆)	IO_L19P_4	AB16	I/O
4	N.C. (◆)	IO_L22N_4/ VREF_4	V15	VREF
4	N.C. (◆)	IO_L22P_4	W15	I/O
4	IO_L24N_4	IO_L24N_4	AA15	I/O
4	IO_L24P_4	IO_L24P_4	AB15	I/O
4	IO_L25N_4	IO_L25N_4	U14	I/O
4	IO_L25P_4	IO_L25P_4	V14	I/O
4	IO_L27N_4/ DIN/D0	IO_L27N_4/ DIN/D0	AA14	DUAL

Table 27: FG456 Package Pinout (Continued)

Bank	3S400 Pin Name	3S1000 3S1500 Pin Name	FG456 Pin Number	Type
4	IO_L27P_4/D1	IO_L27P_4/D1	AB14	DUAL
4	IO_L28N_4	IO_L28N_4	U13	I/O
4	IO_L28P_4	IO_L28P_4	V13	I/O
4	IO_L29N_4	IO_L29N_4	Y13	I/O
4	IO_L29P_4	IO_L29P_4	AA13	I/O
4	IO_L30N_4/D2	IO_L30N_4/D2	U12	DUAL
4	IO_L30P_4/D3	IO_L30P_4/D3	V12	DUAL
4	IO_L31N_4/INIT_B	IO_L31N_4/INIT_B	W12	DUAL
4	IO_L31P_4/DOUT/BUSY	IO_L31P_4/DOUT/BUSY	Y12	DUAL
4	IO_L32N_4/GCLK1	IO_L32N_4/GCLK1	AA12	GCLK
4	IO_L32P_4/GCLK0	IO_L32P_4/GCLK0	AB12	GCLK
4	VCCO_4	VCCO_4	T12	VCCO
4	VCCO_4	VCCO_4	T13	VCCO
4	VCCO_4	VCCO_4	T14	VCCO
4	VCCO_4	VCCO_4	U15	VCCO
4	VCCO_4	VCCO_4	Y15	VCCO
5	IO	IO	U7	I/O
5	N.C. (◆)	IO	U9	I/O
5	IO	IO	U10	I/O
5	IO	IO	U11	I/O
5	IO	IO	V7	I/O
5	IO	IO	V10	I/O
5	IO/VREF_5	IO/VREF_5	AB11	VREF
5	IO/VREF_5	IO/VREF_5	U6	VREF
5	IO_L01N_5/RDWR_B	IO_L01N_5/RDWR_B	Y4	DUAL
5	IO_L01P_5/CS_B	IO_L01P_5/CS_B	AA3	DUAL
5	IO_L06N_5	IO_L06N_5	AB4	I/O
5	IO_L06P_5	IO_L06P_5	AA4	I/O
5	IO_L09N_5	IO_L09N_5	Y5	I/O
5	IO_L09P_5	IO_L09P_5	W5	I/O
5	IO_L10N_5/VRP_5	IO_L10N_5/VRP_5	AB5	DCI
5	IO_L10P_5/VRN_5	IO_L10P_5/VRN_5	AA5	DCI
5	IO_L15N_5	IO_L15N_5	W6	I/O
5	IO_L15P_5	IO_L15P_5	V6	I/O
5	IO_L16N_5	IO_L16N_5	AA6	I/O
5	IO_L16P_5	IO_L16P_5	Y6	I/O

Table 27: FG456 Package Pinout (Continued)

Bank	3S400 Pin Name	3S1000 3S1500 Pin Name	FG456 Pin Number	Type
5	N.C. (◆)	IO_L19N_5	Y7	I/O
5	N.C. (◆)	IO_L19P_5/VREF_5	W7	VREF
5	N.C. (◆)	IO_L22N_5	AB7	I/O
5	N.C. (◆)	IO_L22P_5	AA7	I/O
5	IO_L24N_5	IO_L24N_5	W8	I/O
5	IO_L24P_5	IO_L24P_5	V8	I/O
5	IO_L25N_5	IO_L25N_5	AB8	I/O
5	IO_L25P_5	IO_L25P_5	AA8	I/O
5	IO_L27N_5/VREF_5	IO_L27N_5/VREF_5	W9	VREF
5	IO_L27P_5	IO_L27P_5	V9	I/O
5	IO_L28N_5/D6	IO_L28N_5/D6	AB9	DUAL
5	IO_L28P_5/D7	IO_L28P_5/D7	AA9	DUAL
5	IO_L29N_5	IO_L29N_5	Y10	I/O
5	IO_L29P_5/VREF_5	IO_L29P_5/VREF_5	W10	VREF
5	IO_L30N_5	IO_L30N_5	AB10	I/O
5	IO_L30P_5	IO_L30P_5	AA10	I/O
5	IO_L31N_5/D4	IO_L31N_5/D4	W11	DUAL
5	IO_L31P_5/D5	IO_L31P_5/D5	V11	DUAL
5	IO_L32N_5/GCLK3	IO_L32N_5/GCLK3	AA11	GCLK
5	IO_L32P_5/GCLK2	IO_L32P_5/GCLK2	Y11	GCLK
5	VCCO_5	VCCO_5	T9	VCCO
5	VCCO_5	VCCO_5	T10	VCCO
5	VCCO_5	VCCO_5	T11	VCCO
5	VCCO_5	VCCO_5	U8	VCCO
5	VCCO_5	VCCO_5	Y8	VCCO
6	IO	IO	Y1	I/O
6	IO_L01N_6/VRP_6	IO_L01N_6/VRP_6	Y3	DCI
6	IO_L01P_6/VRN_6	IO_L01P_6/VRN_6	Y2	DCI
6	IO_L16N_6	IO_L16N_6	W4	I/O
6	IO_L16P_6	IO_L16P_6	W3	I/O
6	IO_L17N_6	IO_L17N_6	W2	I/O
6	IO_L17P_6/VREF_6	IO_L17P_6/VREF_6	W1	VREF
6	IO_L19N_6	IO_L19N_6	V5	I/O
6	IO_L19P_6	IO_L19P_6	U5	I/O
6	IO_L20N_6	IO_L20N_6	V4	I/O

Table 27: FG456 Package Pinout (Continued)

Bank	3S400 Pin Name	3S1000 3S1500 Pin Name	FG456 Pin Number	Type
6	IO_L20P_6	IO_L20P_6	V3	I/O
6	IO_L21N_6	IO_L21N_6	V2	I/O
6	IO_L21P_6	IO_L21P_6	V1	I/O
6	IO_L22N_6	IO_L22N_6	T6	I/O
6	IO_L22P_6	IO_L22P_6	T5	I/O
6	IO_L23N_6	IO_L23N_6	U4	I/O
6	IO_L23P_6	IO_L23P_6	T4	I/O
6	IO_L24N_6/ VREF_6	IO_L24N_6/ VREF_6	U3	VREF
6	IO_L24P_6	IO_L24P_6	U2	I/O
6	N.C. (◆)	IO_L26N_6	T3	I/O
6	N.C. (◆)	IO_L26P_6	R4	I/O
6	IO_L27N_6	IO_L27N_6	T2	I/O
6	IO_L27P_6	IO_L27P_6	T1	I/O
6	N.C. (◆)	IO_L28N_6	R5	I/O
6	N.C. (◆)	IO_L28P_6	P6	I/O
6	N.C. (◆)	IO_L29N_6	R2	I/O
6	N.C. (◆)	IO_L29P_6	R1	I/O
6	N.C. (◆)	IO_L31N_6	P5	I/O
6	N.C. (◆)	IO_L31P_6	P4	I/O
6	N.C. (◆)	IO_L32N_6	P2	I/O
6	N.C. (◆)	IO_L32P_6	P1	I/O
6	N.C. (◆)	IO_L33N_6	N6	I/O
6	N.C. (◆)	IO_L33P_6	N5	I/O
6	IO_L34N_6/ VREF_6	IO_L34N_6/ VREF_6	N4	VREF
6	IO_L34P_6	IO_L34P_6	N3	I/O
6	IO_L35N_6	IO_L35N_6	N2	I/O
6	IO_L35P_6	IO_L35P_6	N1	I/O
6	IO_L38N_6	IO_L38N_6	M6	I/O
6	IO_L38P_6	IO_L38P_6	M5	I/O
6	IO_L39N_6	IO_L39N_6	M4	I/O
6	IO_L39P_6	IO_L39P_6	M3	I/O
6	IO_L40N_6	IO_L40N_6	M2	I/O
6	IO_L40P_6/ VREF_6	IO_L40P_6/ VREF_6	M1	VREF
6	VCCO_6	VCCO_6	M7	VCCO
6	VCCO_6	VCCO_6	N7	VCCO
6	VCCO_6	VCCO_6	P7	VCCO
6	VCCO_6	VCCO_6	R3	VCCO
6	VCCO_6	VCCO_6	R6	VCCO
7	IO	IO	C2	I/O
7	IO_L01N_7/ VRP_7	IO_L01N_7/ VRP_7	C3	DCI
7	IO_L01P_7/ VRN_7	IO_L01P_7/ VRN_7	C4	DCI

Table 27: FG456 Package Pinout (Continued)

Bank	3S400 Pin Name	3S1000 3S1500 Pin Name	FG456 Pin Number	Type
7	IO_L16N_7	IO_L16N_7	D1	I/O
7	IO_L16P_7/ VREF_7	IO_L16P_7/ VREF_7	C1	VREF
7	IO_L17N_7	IO_L17N_7	E4	I/O
7	IO_L17P_7	IO_L17P_7	D4	I/O
7	IO_L19N_7/ VREF_7	IO_L19N_7/ VREF_7	D3	VREF
7	IO_L19P_7	IO_L19P_7	D2	I/O
7	IO_L20N_7	IO_L20N_7	F4	I/O
7	IO_L20P_7	IO_L20P_7	E3	I/O
7	IO_L21N_7	IO_L21N_7	E1	I/O
7	IO_L21P_7	IO_L21P_7	E2	I/O
7	IO_L22N_7	IO_L22N_7	G6	I/O
7	IO_L22P_7	IO_L22P_7	F5	I/O
7	IO_L23N_7	IO_L23N_7	F2	I/O
7	IO_L23P_7	IO_L23P_7	F3	I/O
7	IO_L24N_7	IO_L24N_7	H5	I/O
7	IO_L24P_7	IO_L24P_7	G5	I/O
7	N.C. (◆)	IO_L26N_7	G3	I/O
7	N.C. (◆)	IO_L26P_7	G4	I/O
7	IO_L27N_7	IO_L27N_7	G1	I/O
7	IO_L27P_7/ VREF_7	IO_L27P_7/ VREF_7	G2	VREF
7	N.C. (◆)	IO_L28N_7	H1	I/O
7	N.C. (◆)	IO_L28P_7	H2	I/O
7	N.C. (◆)	IO_L29N_7	J4	I/O
7	N.C. (◆)	IO_L29P_7	H4	I/O
7	N.C. (◆)	IO_L31N_7	J5	I/O
7	N.C. (◆)	IO_L31P_7	J6	I/O
7	N.C. (◆)	IO_L32N_7	J1	I/O
7	N.C. (◆)	IO_L32P_7	J2	I/O
7	N.C. (◆)	IO_L33N_7	K5	I/O
7	N.C. (◆)	IO_L33P_7	K6	I/O
7	IO_L34N_7	IO_L34N_7	K3	I/O
7	IO_L34P_7	IO_L34P_7	K4	I/O
7	IO_L35N_7	IO_L35N_7	K1	I/O
7	IO_L35P_7	IO_L35P_7	K2	I/O
7	IO_L38N_7	IO_L38N_7	L5	I/O
7	IO_L38P_7	IO_L38P_7	L6	I/O
7	IO_L39N_7	IO_L39N_7	L3	I/O
7	IO_L39P_7	IO_L39P_7	L4	I/O
7	IO_L40N_7/ VREF_7	IO_L40N_7/ VREF_7	L1	VREF
7	IO_L40P_7	IO_L40P_7	L2	I/O
7	VCCO_7	VCCO_7	H3	VCCO
7	VCCO_7	VCCO_7	H6	VCCO

Table 27: FG456 Package Pinout (Continued)

Bank	3S400 Pin Name	3S1000 3S1500 Pin Name	FG456 Pin Number	Type
7	VCCO_7	VCCO_7	J7	VCCO
7	VCCO_7	VCCO_7	K7	VCCO
7	VCCO_7	VCCO_7	L7	VCCO
N/A	GND	GND	A1	GND
N/A	GND	GND	A22	GND
N/A	GND	GND	AA2	GND
N/A	GND	GND	AA21	GND
N/A	GND	GND	AB1	GND
N/A	GND	GND	AB22	GND
N/A	GND	GND	B2	GND
N/A	GND	GND	B21	GND
N/A	GND	GND	C9	GND
N/A	GND	GND	C14	GND
N/A	GND	GND	J3	GND
N/A	GND	GND	J9	GND
N/A	GND	GND	J10	GND
N/A	GND	GND	J11	GND
N/A	GND	GND	J12	GND
N/A	GND	GND	J13	GND
N/A	GND	GND	J14	GND
N/A	GND	GND	J20	GND
N/A	GND	GND	K9	GND
N/A	GND	GND	K10	GND
N/A	GND	GND	K11	GND
N/A	GND	GND	K12	GND
N/A	GND	GND	K13	GND
N/A	GND	GND	K14	GND
N/A	GND	GND	L9	GND
N/A	GND	GND	L10	GND
N/A	GND	GND	L11	GND
N/A	GND	GND	L12	GND
N/A	GND	GND	L13	GND
N/A	GND	GND	L14	GND
N/A	GND	GND	M9	GND
N/A	GND	GND	M10	GND
N/A	GND	GND	M11	GND
N/A	GND	GND	M12	GND
N/A	GND	GND	M13	GND
N/A	GND	GND	M14	GND
N/A	GND	GND	N9	GND
N/A	GND	GND	N10	GND
N/A	GND	GND	N11	GND
N/A	GND	GND	N12	GND
N/A	GND	GND	N13	GND
N/A	GND	GND	N14	GND

Table 27: FG456 Package Pinout (Continued)

Bank	3S400 Pin Name	3S1000 3S1500 Pin Name	FG456 Pin Number	Type
N/A	GND	GND	P3	GND
N/A	GND	GND	P9	GND
N/A	GND	GND	P10	GND
N/A	GND	GND	P11	GND
N/A	GND	GND	P12	GND
N/A	GND	GND	P13	GND
N/A	GND	GND	P14	GND
N/A	GND	GND	P20	GND
N/A	GND	GND	Y9	GND
N/A	GND	GND	Y14	GND
N/A	VCCAUX	VCCAUX	A6	VCCAUX
N/A	VCCAUX	VCCAUX	A17	VCCAUX
N/A	VCCAUX	VCCAUX	AB6	VCCAUX
N/A	VCCAUX	VCCAUX	AB17	VCCAUX
N/A	VCCAUX	VCCAUX	F1	VCCAUX
N/A	VCCAUX	VCCAUX	F22	VCCAUX
N/A	VCCAUX	VCCAUX	U1	VCCAUX
N/A	VCCAUX	VCCAUX	U22	VCCAUX
N/A	VCCINT	VCCINT	G7	VCCINT
N/A	VCCINT	VCCINT	G8	VCCINT
N/A	VCCINT	VCCINT	G15	VCCINT
N/A	VCCINT	VCCINT	G16	VCCINT
N/A	VCCINT	VCCINT	H7	VCCINT
N/A	VCCINT	VCCINT	H16	VCCINT
N/A	VCCINT	VCCINT	R7	VCCINT
N/A	VCCINT	VCCINT	R16	VCCINT
N/A	VCCINT	VCCINT	T7	VCCINT
N/A	VCCINT	VCCINT	T8	VCCINT
N/A	VCCINT	VCCINT	T15	VCCINT
N/A	VCCINT	VCCINT	T16	VCCINT
VCCAUX	CCLK	CCLK	AA22	CONFIG
VCCAUX	DONE	DONE	AB21	CONFIG
VCCAUX	HSWAP_EN	HSWAP_EN	B3	CONFIG
VCCAUX	M0	M0	AB2	CONFIG
VCCAUX	M1	M1	AA1	CONFIG
VCCAUX	M2	M2	AB3	CONFIG
VCCAUX	PROG_B	PROG_B	A2	CONFIG
VCCAUX	TCK	TCK	A21	JTAG
VCCAUX	TDI	TDI	B1	JTAG
VCCAUX	TDO	TDO	B22	JTAG
VCCAUX	TMS	TMS	A20	JTAG

## User I/Os by Bank

Table 28 indicates how the available user-I/O pins are distributed between the eight I/O banks for the XC3S400 in the FG456 package. Similarly, Table 29 shows how the avail-

able user-I/O pins are distributed between the eight I/O banks for the XC3S1000 and XC3S1500 in the FG456 package.

Table 28: User I/Os Per Bank for XC3S400 in FG456 Package

Edge	I/O Bank	Maximum I/O	All Possible I/O Pins by Type				
			I/O	DUAL	DCI	VREF	GCLK
Top	0	35	27	0	2	4	2
	1	35	27	0	2	4	2
Right	2	31	25	0	2	4	0
	3	31	25	0	2	4	0
Bottom	4	35	21	6	2	4	2
	5	35	21	6	2	4	2
Left	6	31	25	0	2	4	0
	7	31	25	0	2	4	0

Table 29: User I/Os Per Bank for XC3S1000 and XC3S1500 in FG456 Package

Edge	I/O Bank	Maximum I/O	All Possible I/O Pins by Type				
			I/O	DUAL	DCI	VREF	GCLK
Top	0	40	31	0	2	5	2
	1	40	31	0	2	5	2
Right	2	43	37	0	2	4	0
	3	43	37	0	2	4	0
Bottom	4	41	26	6	2	5	2
	5	40	25	6	2	5	2
Left	6	43	37	0	2	4	0
	7	43	37	0	2	4	0

### FG456 Footprint

#### Left Half of Package (top view)

##### XC3S400

(264 max. user I/O)

196 I/O: Unrestricted, general-purpose user I/O

32 VREF: User I/O or input voltage reference for bank

69 N.C.: Unconnected pins for XC3S400 (◆)

##### XC3S1000, XC3S1500

(333 max user I/O)

261 I/O: Unrestricted, general-purpose user I/O

36 VREF: User I/O or input voltage reference for bank

0 N.C.: No unconnected pins in this package

##### All devices

12 DUAL: Configuration pin, then possible user I/O

8 GCLK: User I/O or global clock buffer input

16 DCI: User I/O or reference resistor input for bank

7 CONFIG: Dedicated configuration pins

4 JTAG: Dedicated JTAG port pins

12 VCCINT: Internal core voltage supply (+1.2V)

40 VCCO: Output voltage supply for bank

8 VCCAUX: Auxiliary voltage supply (+2.5V)

52 GND: Ground

		Bank 0											
		1	2	3	4	5	6	7	8	9	10	11	
Bank 7	A	GND	PROG_B	I/O VREF_0	I/O L01P_0 VRN_0	I/O L09P_0	VCCAUX	I/O L19P_0	I/O L24P_0	I/O L27P_0	I/O	I/O L32P_0 GCLK6	
	B	TDI	GND	HSWAP_EN	I/O L01N_0 VRP_0	I/O L09N_0	I/O L15P_0	I/O L19N_0	I/O L24N_0	I/O L27N_0	I/O L29P_0	I/O L32N_0 GCLK7	
	C	I/O L16P_7 VREF_7	I/O	I/O L01N_7 VRP_7	I/O L01P_7 VRN_7	I/O L06P_0	I/O L15N_0	I/O VREF_0	VCCO_0	GND	I/O L29N_0	I/O L31P_0 VREF_0	
	D	I/O L16N_7	I/O L19P_7	I/O L19N_7 VREF_7	I/O L17P_7	I/O L06N_0	I/O L10P_0	I/O L16P_0	I/O L22P_0	I/O	I/O	I/O L31N_0	
	E	I/O L21N_7	I/O L21P_7	I/O L20P_7	I/O L17N_7	I/O VREF_0	I/O L10N_0	I/O L16N_0	I/O L22N_0	I/O	I/O L25P_0	I/O L28P_0	I/O L30P_0
	F	VCCAUX	I/O L23N_7	I/O L23P_7	I/O L20N_7	I/O L22P_7	I/O	I/O VREF_0	VCCO_0	I/O L25N_0	I/O L28N_0	I/O L30N_0	
	G	I/O L27N_7	I/O L27P_7 VREF_7	I/O L26N_7	I/O L26P_7	I/O L24P_7	I/O L22N_7	VCCINT	VCCINT	VCCO_0	VCCO_0	VCCO_0	
	H	I/O L28N_7	I/O L28P_7	VCCO_7	I/O L29P_7	I/O L24N_7	VCCO_7	VCCINT					
	J	I/O L32N_7	I/O L32P_7	GND	I/O L29N_7	I/O L31N_7	I/O L31P_7	VCCO_7			GND	GND	GND
	K	I/O L35N_7	I/O L35P_7	I/O L34N_7	I/O L34P_7	I/O L33N_7	I/O L33P_7	VCCO_7			GND	GND	GND
	L	I/O L40N_7 VREF_7	I/O L40P_7	I/O L39N_7	I/O L39P_7	I/O L38N_7	I/O L38P_7	VCCO_7			GND	GND	GND
	M	I/O L40P_6 VREF_6	I/O L40N_6	I/O L39P_6	I/O L39N_6	I/O L38P_6	I/O L38N_6	VCCO_6			GND	GND	GND
	N	I/O L35P_6	I/O L35N_6	I/O L34P_6	I/O L34N_6 VREF_6	I/O L33P_6	I/O L33N_6	VCCO_6			GND	GND	GND
	P	I/O L32P_6	I/O L32N_6	GND	I/O L31P_6	I/O L31N_6	I/O L28P_6	VCCO_6			GND	GND	GND
	R	I/O L29P_6	I/O L29N_6	VCCO_6	I/O L26P_6	I/O L28N_6	VCCO_6	VCCINT					
	Bank 6	T	I/O L27P_6	I/O L27N_6	I/O L26N_6	I/O L23P_6	I/O L22P_6	I/O L22N_6	VCCINT	VCCINT	VCCO_5	VCCO_5	VCCO_5
U		VCCAUX	I/O L24P_6	I/O L24N_6 VREF_6	I/O L23N_6	I/O L19P_6	I/O VREF_5	I/O	VCCO_5	I/O	I/O	I/O	
V		I/O L21P_6	I/O L21N_6	I/O L20P_6	I/O L20N_6	I/O L19N_6	I/O L15P_5	I/O	I/O L24P_5	I/O L27P_5	I/O	I/O L31P_5 D5	
W		I/O L17P_6 VREF_6	I/O L17N_6	I/O L16P_6	I/O L16N_6	I/O L09P_5	I/O L15N_5	I/O L19P_5 VREF_5	I/O L24N_5	I/O L27N_5 VREF_5	I/O L29P_5 VREF_5	I/O L31N_5 D4	
Y		I/O	I/O L01P_6 VRN_6	I/O L01N_6 VRP_6	I/O L01N_5 RDWR_B	I/O L09N_5	I/O L16P_5	I/O L19N_5	VCCO_5	GND	I/O L29N_5	I/O L32P_5 GCLK2	
A		M1	GND	I/O L01P_5 CS_B	I/O L06P_5	I/O L10P_5 VRN_5	I/O L16N_5	I/O L22P_5	I/O L25P_5	I/O L28P_5 D7	I/O L30P_5	I/O L32N_5 GCLK3	
A		GND	M0	M2	I/O L06N_5	I/O L10N_5 VRP_5	VCCAUX	I/O L22N_5	I/O L25N_5	I/O L28N_5 D6	I/O L30N_5	I/O VREF_5	
Bank 5													

Figure 13: FG456 Package Footprint (top view)

DS099-4\_11a\_030203



Bank 1											
12	13	14	15	16	17	18	19	20	21	22	
I/O	I/O L30N_1	I/O L28N_1	I/O L25P_1	I/O L22N_1 ◆	VCCAUX	I/O L10N_1 VREF_1	I/O L06N_1 VREF_1	TMS	TCK	GND	A
I/O L32N_1 GCLK5	I/O L30P_1	I/O L28P_1	I/O L25N_1	I/O L22P_1 ◆	I/O L16N_1	I/O L10P_1	I/O L06P_1	I/O L01P_1 VRN_1	GND	TDO	B
I/O L32P_1 GCLK4	I/O L29N_1	GND	VCCO_1	I/O L19N_1 ◆	I/O L16P_1	I/O L09N_1	I/O L01N_1 VRP_1	I/O L01N_2 VRP_2	I/O L01P_2 VRN_2	I/O	C
I/O L31N_1 VREF_1	I/O L29P_1	I/O L27N_1	I/O L24N_1	I/O L19P_1 ◆	I/O L15N_1	I/O L09P_1	I/O L16P_2	I/O L16N_2	I/O L17N_2	I/O L17P_2 VREF_2	D
I/O L31P_1	I/O VREF_1	I/O L27P_1	I/O L24P_1	I/O	I/O L15P_1	I/O L19N_2	I/O L20N_2	I/O L20P_2	I/O L21N_2	I/O L21P_2	E
I/O	I/O	I/O VREF_1 ◆	VCCO_1	I/O	I/O	I/O L19P_2	I/O L23N_2 VREF_2	I/O L24N_2	I/O L24P_2	VCCAUX	F
VCCO_1	VCCO_1	VCCO_1	VCCINT	VCCINT	I/O L22N_2	I/O L22P_2	I/O L23P_2	I/O L26N_2 ◆	I/O L27N_2	I/O L27P_2	G Bank 2
◆	◆	◆	◆	VCCINT	VCCO_2	I/O L28N_2 ◆	I/O L26P_2 ◆	VCCO_2	I/O L29N_2 ◆	I/O L29P_2 ◆	H
GND	GND	GND	◆	VCCO_2	I/O L28P_2 ◆	I/O L31N_2 ◆	I/O L31P_2 ◆	GND	I/O L32N_2 ◆	I/O L32P_2 ◆	J
GND	GND	GND	◆	VCCO_2	I/O L33N_2 ◆	I/O L33P_2 ◆	I/O L34N_2 VREF_2	I/O L34P_2	I/O L35N_2	I/O L35P_2	K
GND	GND	GND	◆	VCCO_2	I/O L38N_2	I/O L38P_2	I/O L39N_2	I/O L39P_2	I/O L40N_2	I/O L40P_2 VREF_2	L
GND	GND	GND	◆	VCCO_3	I/O L38P_3	I/O L38N_3	I/O L39P_3	I/O L39N_3	I/O L40P_3	I/O L40N_3 VREF_3	M
GND	GND	GND	◆	VCCO_3	I/O L33P_3 ◆	I/O L33N_3 ◆	I/O L34P_3 VREF_3	I/O L34N_3	I/O L35P_3	I/O L35N_3	N
GND	GND	GND	◆	VCCO_3	I/O L31P_3 ◆	I/O L31N_3 ◆	I/O L29N_3 ◆	GND	I/O L32P_3 ◆	I/O L32N_3 ◆	P
◆	◆	◆	VCCINT	VCCO_3	I/O L24N_3	I/O L29P_3 ◆	VCCO_3	I/O L28P_3 ◆	I/O L28N_3 ◆	◆	R
VCCO_4	VCCO_4	VCCO_4	VCCINT	VCCINT	I/O L22N_3	I/O L24P_3	I/O L26P_3 ◆	I/O L26N_3 ◆	I/O L27P_3	I/O L27N_3	G Bank 3
I/O L30N_4 D2	I/O L28N_4	I/O L25N_4	VCCO_4	I/O	I/O	I/O L22P_3	I/O L20N_3	I/O L23P_3 VREF_3	I/O L23N_3	VCCAUX	U
I/O L30P_4 D3	I/O L28P_4	I/O L25P_4	I/O L22N_4 VREF_4 ◆	I/O L16N_4	I/O L10N_4	I/O VREF_4	I/O L17N_3	I/O L20P_3	I/O L21P_3	I/O L21N_3	V
I/O L31N_4 INIT_B	I/O	I/O	I/O L22P_4 ◆	I/O L16P_4	I/O L10P_4	I/O L06N_4 VREF_4	I/O L17P_3 VREF_3	I/O L19P_3	I/O L19N_3	I/O L16N_3	W
I/O L31P_4 DOUT BUSY	I/O L29N_4	GND	VCCO_4	I/O VREF_4	I/O L15N_4	I/O L06P_4	I/O L01P_3 VRN_3	I/O L01N_3 VRP_3	I/O	I/O L16P_3	Y
I/O L32N_4 GCLK1	I/O L29P_4	I/O L27N_4 DN D0	I/O L24N_4	I/O L19N_4 ◆	I/O L15P_4	I/O L09N_4	I/O L05N_4 ◆	I/O L01N_4 VRP_4	GND	CCLK	A A
I/O L32P_4 GCLK0	I/O VREF_4	I/O L27P_4 D1	I/O L24P_4	I/O L19P_4 ◆	VCCAUX	I/O L09P_4	I/O L05P_4 ◆	I/O L01P_4 VRN_4	DONE	GND	A B

Right Half of Package  
(top view)

Bank 4

DS099-4\_11b\_030503

## FG676: 676-lead Fine-pitch Ball Grid Array

The 676-lead fine-pitch ball grid array package, FG676, supports three different Spartan-3 devices, including the XC3S1000, the XC3S1500, and the XC3S2000. All three have nearly identical footprints but are slightly different due to unconnected pins on the XC3S1000 and XC3S1500. For example, because the XC3S1000 has fewer I/O pins, this device has 98 unconnected pins on the FG676 package, labeled as “N.C.” In [Table 30](#) and [Figure 14](#), these unconnected pins are indicated with a black diamond symbol (◆). The XC3S1500, however, has only two unconnected pins, also labeled “N.C.” in the pinout table but indicated with a black square symbol (■).

All the package pins appear in [Table 30](#) and are sorted by bank number, then by pin name. Pairs of pins that form a differential I/O pair appear together in the table. The table also shows the pin number for each pin and the pin type, as defined earlier.

If there is a difference between the XC1000, XC3S1500 and XC3S2000 pinouts, then that difference is highlighted in [Table 30](#). If the table entry is shaded grey, then there is an unconnected pin on either the XC3S1000 or XC3S1500 that maps to a user-I/O pin on the XC3S2000. If the table entry is shaded tan, then the unconnected pin on either the XC3S1000 or XC3S1500 maps to a VREF-type pin on the XC3S2000. If the other VREF pins in the bank all connect to a voltage reference to support a special I/O standard, then also connect the N.C. pin on the XC3S1000 or XC3S1500 to the same VREF voltage. This provides maximum flexibility as you could potentially migrate a design from the XC3S1000 through to the XC3S2000 FPGA without changing the printed circuit board.

### Pinout Table

Table 30: FG676 Package Pinout

Bank	XC3S1000 Pin Name	XC3S1500 Pin Name	XC3S2000 Pin Name	FG676 Pin Number	Type
0	IO	IO	IO	A3	I/O
0	IO	IO	IO	A5	I/O
0	IO	IO	IO	A6	I/O
0	IO	IO	IO	C4	I/O
0	N.C. (◆)	IO	IO	C8	I/O
0	IO	IO	IO	C12	I/O
0	IO	IO	IO	E13	I/O
0	IO	IO	IO	H11	I/O
0	IO	IO	IO	H12	I/O
0	IO/VREF_0	IO/VREF_0	IO/VREF_0	B3	VREF
0	IO/VREF_0	IO/VREF_0	IO/VREF_0	F7	VREF
0	IO/VREF_0	IO/VREF_0	IO/VREF_0	G10	VREF
0	IO_L01N_0/ VRP_0	IO_L01N_0/ VRP_0	IO_L01N_0/ VRP_0	E5	DCI

Table 30: FG676 Package Pinout (Continued)

Bank	XC3S1000 Pin Name	XC3S1500 Pin Name	XC3S2000 Pin Name	FG676 Pin Number	Type
0	IO_L01P_0/ VRN_0	IO_L01P_0/ VRN_0	IO_L01P_0/ VRN_0	D5	DCI
0	IO_L05N_0	IO_L05N_0	IO_L05N_0	B4	I/O
0	IO_L05P_0/ VREF_0	IO_L05P_0/ VREF_0	IO_L05P_0/ VREF_0	A4	VREF
0	IO_L06N_0	IO_L06N_0	IO_L06N_0	C5	I/O
0	IO_L06P_0	IO_L06P_0	IO_L06P_0	B5	I/O
0	IO_L07N_0	IO_L07N_0	IO_L07N_0	E6	I/O
0	IO_L07P_0	IO_L07P_0	IO_L07P_0	D6	I/O
0	IO_L08N_0	IO_L08N_0	IO_L08N_0	C6	I/O
0	IO_L08P_0	IO_L08P_0	IO_L08P_0	B6	I/O
0	IO_L09N_0	IO_L09N_0	IO_L09N_0	E7	I/O
0	IO_L09P_0	IO_L09P_0	IO_L09P_0	D7	I/O
0	IO_L10N_0	IO_L10N_0	IO_L10N_0	B7	I/O
0	IO_L10P_0	IO_L10P_0	IO_L10P_0	A7	I/O
0	N.C. (◆)	IO_L11N_0	IO_L11N_0	G8	I/O
0	N.C. (◆)	IO_L11P_0	IO_L11P_0	F8	I/O
0	N.C. (◆)	IO_L12N_0	IO_L12N_0	E8	I/O
0	N.C. (◆)	IO_L12P_0	IO_L12P_0	D8	I/O
0	IO_L15N_0	IO_L15N_0	IO_L15N_0	B8	I/O
0	IO_L15P_0	IO_L15P_0	IO_L15P_0	A8	I/O
0	IO_L16N_0	IO_L16N_0	IO_L16N_0	G9	I/O
0	IO_L16P_0	IO_L16P_0	IO_L16P_0	F9	I/O
0	N.C. (◆)	IO_L17N_0	IO_L17N_0	E9	I/O
0	N.C. (◆)	IO_L17P_0	IO_L17P_0	D9	I/O
0	N.C. (◆)	IO_L18N_0	IO_L18N_0	C9	I/O
0	N.C. (◆)	IO_L18P_0	IO_L18P_0	B9	I/O
0	IO_L19N_0	IO_L19N_0	IO_L19N_0	F10	I/O
0	IO_L19P_0	IO_L19P_0	IO_L19P_0	E10	I/O
0	IO_L22N_0	IO_L22N_0	IO_L22N_0	D10	I/O
0	IO_L22P_0	IO_L22P_0	IO_L22P_0	C10	I/O
0	N.C. (◆)	IO_L23N_0	IO_L23N_0	B10	I/O
0	N.C. (◆)	IO_L23P_0	IO_L23P_0	A10	I/O
0	IO_L24N_0	IO_L24N_0	IO_L24N_0	G11	I/O
0	IO_L24P_0	IO_L24P_0	IO_L24P_0	F11	I/O
0	IO_L25N_0	IO_L25N_0	IO_L25N_0	E11	I/O
0	IO_L25P_0	IO_L25P_0	IO_L25P_0	D11	I/O
0	N.C. (◆)	IO_L26N_0	IO_L26N_0	B11	I/O
0	N.C. (◆)	IO_L26P_0/ VREF_0	IO_L26P_0/ VREF_0	A11	VREF
0	IO_L27N_0	IO_L27N_0	IO_L27N_0	G12	I/O
0	IO_L27P_0	IO_L27P_0	IO_L27P_0	H13	I/O
0	IO_L28N_0	IO_L28N_0	IO_L28N_0	F12	I/O
0	IO_L28P_0	IO_L28P_0	IO_L28P_0	E12	I/O
0	IO_L29N_0	IO_L29N_0	IO_L29N_0	B12	I/O
0	IO_L29P_0	IO_L29P_0	IO_L29P_0	A12	I/O

Table 30: FG676 Package Pinout (Continued)

Bank	XC3S1000 Pin Name	XC3S1500 Pin Name	XC3S2000 Pin Name	FG676 Pin Number	Type
0	IO_L30N_0	IO_L30N_0	IO_L30N_0	G13	I/O
0	IO_L30P_0	IO_L30P_0	IO_L30P_0	F13	I/O
0	IO_L31N_0	IO_L31N_0	IO_L31N_0	D13	I/O
0	IO_L31P_0/ VREF_0	IO_L31P_0/ VREF_0	IO_L31P_0/ VREF_0	C13	VREF
0	IO_L32N_0/ GCLK7	IO_L32N_0/ GCLK7	IO_L32N_0/ GCLK7	B13	GCLK
0	IO_L32P_0/ GCLK6	IO_L32P_0/ GCLK6	IO_L32P_0/ GCLK6	A13	GCLK
0	VCCO_0	VCCO_0	VCCO_0	C7	VCCO
0	VCCO_0	VCCO_0	VCCO_0	C11	VCCO
0	VCCO_0	VCCO_0	VCCO_0	H9	VCCO
0	VCCO_0	VCCO_0	VCCO_0	H10	VCCO
0	VCCO_0	VCCO_0	VCCO_0	J11	VCCO
0	VCCO_0	VCCO_0	VCCO_0	J12	VCCO
0	VCCO_0	VCCO_0	VCCO_0	J13	VCCO
0	VCCO_0	VCCO_0	VCCO_0	K13	VCCO
1	IO	IO	IO	A14	I/O
1	IO	IO	IO	A22	I/O
1	IO	IO	IO	A23	I/O
1	IO	IO	IO	D16	I/O
1	IO	IO	IO	E18	I/O
1	IO	IO	IO	F14	I/O
1	IO	IO	IO	F20	I/O
1	IO	IO	IO	G19	I/O
1	IO/VREF_1	IO/VREF_1	IO/VREF_1	C15	VREF
1	IO/VREF_1	IO/VREF_1	IO/VREF_1	C17	VREF
1	N.C. (◆)	IO/VREF_1	IO/VREF_1	D18	VREF
1	IO_L01N_1/ VRP_1	IO_L01N_1/ VRP_1	IO_L01N_1/ VRP_1	D22	DCI
1	IO_L01P_1/ VRN_1	IO_L01P_1/ VRN_1	IO_L01P_1/ VRN_1	E22	DCI
1	IO_L04N_1	IO_L04N_1	IO_L04N_1	B23	I/O
1	IO_L04P_1	IO_L04P_1	IO_L04P_1	C23	I/O
1	IO_L05N_1	IO_L05N_1	IO_L05N_1	E21	I/O
1	IO_L05P_1	IO_L05P_1	IO_L05P_1	F21	I/O
1	IO_L06N_1/ VREF_1	IO_L06N_1/ VREF_1	IO_L06N_1/ VREF_1	B22	VREF
1	IO_L06P_1	IO_L06P_1	IO_L06P_1	C22	I/O
1	IO_L07N_1	IO_L07N_1	IO_L07N_1	C21	I/O
1	IO_L07P_1	IO_L07P_1	IO_L07P_1	D21	I/O
1	IO_L08N_1	IO_L08N_1	IO_L08N_1	A21	I/O
1	IO_L08P_1	IO_L08P_1	IO_L08P_1	B21	I/O
1	IO_L09N_1	IO_L09N_1	IO_L09N_1	D20	I/O
1	IO_L09P_1	IO_L09P_1	IO_L09P_1	E20	I/O
1	IO_L10N_1/ VREF_1	IO_L10N_1/ VREF_1	IO_L10N_1/ VREF_1	A20	VREF

Table 30: FG676 Package Pinout (Continued)

Bank	XC3S1000 Pin Name	XC3S1500 Pin Name	XC3S2000 Pin Name	FG676 Pin Number	Type
1	IO_L10P_1	IO_L10P_1	IO_L10P_1	B20	I/O
1	N.C. (◆)	IO_L11N_1	IO_L11N_1	E19	I/O
1	N.C. (◆)	IO_L11P_1	IO_L11P_1	F19	I/O
1	N.C. (◆)	IO_L12N_1	IO_L12N_1	C19	I/O
1	N.C. (◆)	IO_L12P_1	IO_L12P_1	D19	I/O
1	IO_L15N_1	IO_L15N_1	IO_L15N_1	A19	I/O
1	IO_L15P_1	IO_L15P_1	IO_L15P_1	B19	I/O
1	IO_L16N_1	IO_L16N_1	IO_L16N_1	F18	I/O
1	IO_L16P_1	IO_L16P_1	IO_L16P_1	G18	I/O
1	N.C. (◆)	IO_L18N_1	IO_L18N_1	B18	I/O
1	N.C. (◆)	IO_L18P_1	IO_L18P_1	C18	I/O
1	IO_L19N_1	IO_L19N_1	IO_L19N_1	F17	I/O
1	IO_L19P_1	IO_L19P_1	IO_L19P_1	G17	I/O
1	IO_L22N_1	IO_L22N_1	IO_L22N_1	D17	I/O
1	IO_L22P_1	IO_L22P_1	IO_L22P_1	E17	I/O
1	N.C. (◆)	IO_L23N_1	IO_L23N_1	A17	I/O
1	N.C. (◆)	IO_L23P_1	IO_L23P_1	B17	I/O
1	IO_L24N_1	IO_L24N_1	IO_L24N_1	G16	I/O
1	IO_L24P_1	IO_L24P_1	IO_L24P_1	H16	I/O
1	IO_L25N_1	IO_L25N_1	IO_L25N_1	E16	I/O
1	IO_L25P_1	IO_L25P_1	IO_L25P_1	F16	I/O
1	N.C. (◆)	IO_L26N_1	IO_L26N_1	A16	I/O
1	N.C. (◆)	IO_L26P_1	IO_L26P_1	B16	I/O
1	IO_L27N_1	IO_L27N_1	IO_L27N_1	G15	I/O
1	IO_L27P_1	IO_L27P_1	IO_L27P_1	H15	I/O
1	IO_L28N_1	IO_L28N_1	IO_L28N_1	E15	I/O
1	IO_L28P_1	IO_L28P_1	IO_L28P_1	F15	I/O
1	IO_L29N_1	IO_L29N_1	IO_L29N_1	A15	I/O
1	IO_L29P_1	IO_L29P_1	IO_L29P_1	B15	I/O
1	IO_L30N_1	IO_L30N_1	IO_L30N_1	G14	I/O
1	IO_L30P_1	IO_L30P_1	IO_L30P_1	H14	I/O
1	IO_L31N_1/ VREF_1	IO_L31N_1/ VREF_1	IO_L31N_1/ VREF_1	D14	VREF
1	IO_L31P_1	IO_L31P_1	IO_L31P_1	E14	I/O
1	IO_L32N_1/ GCLK5	IO_L32N_1/ GCLK5	IO_L32N_1/ GCLK5	B14	GCLK
1	IO_L32P_1/ GCLK4	IO_L32P_1/ GCLK4	IO_L32P_1/ GCLK4	C14	GCLK
1	VCCO_1	VCCO_1	VCCO_1	C16	VCCO
1	VCCO_1	VCCO_1	VCCO_1	C20	VCCO
1	VCCO_1	VCCO_1	VCCO_1	H17	VCCO
1	VCCO_1	VCCO_1	VCCO_1	H18	VCCO
1	VCCO_1	VCCO_1	VCCO_1	J14	VCCO
1	VCCO_1	VCCO_1	VCCO_1	J15	VCCO
1	VCCO_1	VCCO_1	VCCO_1	J16	VCCO

Table 30: FG676 Package Pinout (Continued)

Bank	XC3S1000 Pin Name	XC3S1500 Pin Name	XC3S2000 Pin Name	FG676 Pin Number	Type
1	VCCO_1	VCCO_1	VCCO_1	K14	VCCO
2	N.C. (◆)	N.C. (■)	IO	F22	I/O
2	IO_L01N_2/ VRP_2	IO_L01N_2/ VRP_2	IO_L01N_2/ VRP_2	C25	DCI
2	IO_L01P_2/ VRN_2	IO_L01P_2/ VRN_2	IO_L01P_2/ VRN_2	C26	DCI
2	IO_L02N_2	IO_L02N_2	IO_L02N_2	E23	I/O
2	IO_L02P_2	IO_L02P_2	IO_L02P_2	E24	I/O
2	IO_L03N_2/ VREF_2	IO_L03N_2/ VREF_2	IO_L03N_2/ VREF_2	D25	VREF
2	IO_L03P_2	IO_L03P_2	IO_L03P_2	D26	I/O
2	N.C. (◆)	IO_L05N_2	IO_L05N_2	E25	I/O
2	N.C. (◆)	IO_L05P_2	IO_L05P_2	E26	I/O
2	N.C. (◆)	IO_L06N_2	IO_L06N_2	G20	I/O
2	N.C. (◆)	IO_L06P_2	IO_L06P_2	G21	I/O
2	N.C. (◆)	IO_L07N_2	IO_L07N_2	F23	I/O
2	N.C. (◆)	IO_L07P_2	IO_L07P_2	F24	I/O
2	N.C. (◆)	IO_L08N_2	IO_L08N_2	G22	I/O
2	N.C. (◆)	IO_L08P_2	IO_L08P_2	G23	I/O
2	N.C. (◆)	IO_L09N_2/ VREF_2	IO_L09N_2/ VREF_2	F25	VREF
2	N.C. (◆)	IO_L09P_2	IO_L09P_2	F26	I/O
2	N.C. (◆)	IO_L10N_2	IO_L10N_2	G25	I/O
2	N.C. (◆)	IO_L10P_2	IO_L10P_2	G26	I/O
2	IO_L14N_2	IO_L14N_2	IO_L14N_2	H20	I/O
2	IO_L14P_2	IO_L14P_2	IO_L14P_2	H21	I/O
2	IO_L16N_2	IO_L16N_2	IO_L16N_2	H22	I/O
2	IO_L16P_2	IO_L16P_2	IO_L16P_2	J21	I/O
2	IO_L17N_2	IO_L17N_2	IO_L17N_2	H23	I/O
2	IO_L17P_2/ VREF_2	IO_L17P_2/ VREF_2	IO_L17P_2/ VREF_2	H24	VREF
2	IO_L19N_2	IO_L19N_2	IO_L19N_2	H25	I/O
2	IO_L19P_2	IO_L19P_2	IO_L19P_2	H26	I/O
2	IO_L20N_2	IO_L20N_2	IO_L20N_2	J20	I/O
2	IO_L20P_2	IO_L20P_2	IO_L20P_2	K20	I/O
2	IO_L21N_2	IO_L21N_2	IO_L21N_2	J22	I/O
2	IO_L21P_2	IO_L21P_2	IO_L21P_2	J23	I/O
2	IO_L22N_2	IO_L22N_2	IO_L22N_2	J24	I/O
2	IO_L22P_2	IO_L22P_2	IO_L22P_2	J25	I/O
2	IO_L23N_2/ VREF_2	IO_L23N_2/ VREF_2	IO_L23N_2/ VREF_2	K21	VREF
2	IO_L23P_2	IO_L23P_2	IO_L23P_2	K22	I/O
2	IO_L24N_2	IO_L24N_2	IO_L24N_2	K23	I/O
2	IO_L24P_2	IO_L24P_2	IO_L24P_2	K24	I/O
2	IO_L26N_2	IO_L26N_2	IO_L26N_2	K25	I/O
2	IO_L26P_2	IO_L26P_2	IO_L26P_2	K26	I/O
2	IO_L27N_2	IO_L27N_2	IO_L27N_2	L19	I/O

Table 30: FG676 Package Pinout (Continued)

Bank	XC3S1000 Pin Name	XC3S1500 Pin Name	XC3S2000 Pin Name	FG676 Pin Number	Type
2	IO_L27P_2	IO_L27P_2	IO_L27P_2	L20	I/O
2	IO_L28N_2	IO_L28N_2	IO_L28N_2	L21	I/O
2	IO_L28P_2	IO_L28P_2	IO_L28P_2	L22	I/O
2	IO_L29N_2	IO_L29N_2	IO_L29N_2	L25	I/O
2	IO_L29P_2	IO_L29P_2	IO_L29P_2	L26	I/O
2	IO_L31N_2	IO_L31N_2	IO_L31N_2	M19	I/O
2	IO_L31P_2	IO_L31P_2	IO_L31P_2	M20	I/O
2	IO_L32N_2	IO_L32N_2	IO_L32N_2	M21	I/O
2	IO_L32P_2	IO_L32P_2	IO_L32P_2	M22	I/O
2	IO_L33N_2	IO_L33N_2	IO_L33N_2	L23	I/O
2	IO_L33P_2	IO_L33P_2	IO_L33P_2	M24	I/O
2	IO_L34N_2/ VREF_2	IO_L34N_2/ VREF_2	IO_L34N_2/ VREF_2	M25	VREF
2	IO_L34P_2	IO_L34P_2	IO_L34P_2	M26	I/O
2	IO_L35N_2	IO_L35N_2	IO_L35N_2	N19	I/O
2	IO_L35P_2	IO_L35P_2	IO_L35P_2	N20	I/O
2	IO_L38N_2	IO_L38N_2	IO_L38N_2	N21	I/O
2	IO_L38P_2	IO_L38P_2	IO_L38P_2	N22	I/O
2	IO_L39N_2	IO_L39N_2	IO_L39N_2	N23	I/O
2	IO_L39P_2	IO_L39P_2	IO_L39P_2	N24	I/O
2	IO_L40N_2	IO_L40N_2	IO_L40N_2	N25	I/O
2	IO_L40P_2/ VREF_2	IO_L40P_2/ VREF_2	IO_L40P_2/ VREF_2	N26	VREF
2	VCCO_2	VCCO_2	VCCO_2	G24	VCCO
2	VCCO_2	VCCO_2	VCCO_2	J19	VCCO
2	VCCO_2	VCCO_2	VCCO_2	K19	VCCO
2	VCCO_2	VCCO_2	VCCO_2	L18	VCCO
2	VCCO_2	VCCO_2	VCCO_2	L24	VCCO
2	VCCO_2	VCCO_2	VCCO_2	M18	VCCO
2	VCCO_2	VCCO_2	VCCO_2	N17	VCCO
2	VCCO_2	VCCO_2	VCCO_2	N18	VCCO
3	IO_L01N_3/ VRP_3	IO_L01N_3/ VRP_3	IO_L01N_3/ VRP_3	AA22	DCI
3	IO_L01P_3/ VRN_3	IO_L01P_3/ VRN_3	IO_L01P_3/ VRN_3	AA21	DCI
3	IO_L02N_3/ VREF_3	IO_L02N_3/ VREF_3	IO_L02N_3/ VREF_3	AB24	VREF
3	IO_L02P_3	IO_L02P_3	IO_L02P_3	AB23	I/O
3	IO_L03N_3	IO_L03N_3	IO_L03N_3	AC26	I/O
3	IO_L03P_3	IO_L03P_3	IO_L03P_3	AC25	I/O
3	N.C. (◆)	IO_L05N_3	IO_L05N_3	Y21	I/O
3	N.C. (◆)	IO_L05P_3	IO_L05P_3	Y20	I/O
3	N.C. (◆)	IO_L06N_3	IO_L06N_3	AB26	I/O
3	N.C. (◆)	IO_L06P_3	IO_L06P_3	AB25	I/O
3	N.C. (◆)	IO_L07N_3	IO_L07N_3	AA24	I/O
3	N.C. (◆)	IO_L07P_3	IO_L07P_3	AA23	I/O
3	N.C. (◆)	IO_L08N_3	IO_L08N_3	Y23	I/O

Table 30: FG676 Package Pinout (Continued)

Bank	XC3S1000 Pin Name	XC3S1500 Pin Name	XC3S2000 Pin Name	FG676 Pin Number	Type
3	N.C. (◆)	IO_L08P_3	IO_L08P_3	Y22	I/O
3	N.C. (◆)	IO_L09N_3	IO_L09N_3	AA26	I/O
3	N.C. (◆)	IO_L09P_3/ VREF_3	IO_L09P_3/ VREF_3	AA25	VREF
3	N.C. (◆)	IO_L10N_3	IO_L10N_3	W21	I/O
3	N.C. (◆)	IO_L10P_3	IO_L10P_3	W20	I/O
3	IO_L14N_3	IO_L14N_3	IO_L14N_3	Y26	I/O
3	IO_L14P_3	IO_L14P_3	IO_L14P_3	Y25	I/O
3	IO_L16N_3	IO_L16N_3	IO_L16N_3	V21	I/O
3	IO_L16P_3	IO_L16P_3	IO_L16P_3	W22	I/O
3	IO_L17N_3	IO_L17N_3	IO_L17N_3	W24	I/O
3	IO_L17P_3/ VREF_3	IO_L17P_3/ VREF_3	IO_L17P_3/ VREF_3	W23	VREF
3	IO_L19N_3	IO_L19N_3	IO_L19N_3	W26	I/O
3	IO_L19P_3	IO_L19P_3	IO_L19P_3	W25	I/O
3	IO_L20N_3	IO_L20N_3	IO_L20N_3	U20	I/O
3	IO_L20P_3	IO_L20P_3	IO_L20P_3	V20	I/O
3	IO_L21N_3	IO_L21N_3	IO_L21N_3	V23	I/O
3	IO_L21P_3	IO_L21P_3	IO_L21P_3	V22	I/O
3	IO_L22N_3	IO_L22N_3	IO_L22N_3	V25	I/O
3	IO_L22P_3	IO_L22P_3	IO_L22P_3	V24	I/O
3	IO_L23N_3	IO_L23N_3	IO_L23N_3	U22	I/O
3	IO_L23P_3/ VREF_3	IO_L23P_3/ VREF_3	IO_L23P_3/ VREF_3	U21	VREF
3	IO_L24N_3	IO_L24N_3	IO_L24N_3	U24	I/O
3	IO_L24P_3	IO_L24P_3	IO_L24P_3	U23	I/O
3	IO_L26N_3	IO_L26N_3	IO_L26N_3	U26	I/O
3	IO_L26P_3	IO_L26P_3	IO_L26P_3	U25	I/O
3	IO_L27N_3	IO_L27N_3	IO_L27N_3	T20	I/O
3	IO_L27P_3	IO_L27P_3	IO_L27P_3	T19	I/O
3	IO_L28N_3	IO_L28N_3	IO_L28N_3	T22	I/O
3	IO_L28P_3	IO_L28P_3	IO_L28P_3	T21	I/O
3	IO_L29N_3	IO_L29N_3	IO_L29N_3	T26	I/O
3	IO_L29P_3	IO_L29P_3	IO_L29P_3	T25	I/O
3	IO_L31N_3	IO_L31N_3	IO_L31N_3	R20	I/O
3	IO_L31P_3	IO_L31P_3	IO_L31P_3	R19	I/O
3	IO_L32N_3	IO_L32N_3	IO_L32N_3	R22	I/O
3	IO_L32P_3	IO_L32P_3	IO_L32P_3	R21	I/O
3	IO_L33N_3	IO_L33N_3	IO_L33N_3	R24	I/O
3	IO_L33P_3	IO_L33P_3	IO_L33P_3	T23	I/O
3	IO_L34N_3	IO_L34N_3	IO_L34N_3	R26	I/O
3	IO_L34P_3/ VREF_3	IO_L34P_3/ VREF_3	IO_L34P_3/ VREF_3	R25	VREF
3	IO_L35N_3	IO_L35N_3	IO_L35N_3	P20	I/O
3	IO_L35P_3	IO_L35P_3	IO_L35P_3	P19	I/O
3	IO_L38N_3	IO_L38N_3	IO_L38N_3	P22	I/O

Table 30: FG676 Package Pinout (Continued)

Bank	XC3S1000 Pin Name	XC3S1500 Pin Name	XC3S2000 Pin Name	FG676 Pin Number	Type
3	IO_L38P_3	IO_L38P_3	IO_L38P_3	P21	I/O
3	IO_L39N_3	IO_L39N_3	IO_L39N_3	P24	I/O
3	IO_L39P_3	IO_L39P_3	IO_L39P_3	P23	I/O
3	IO_L40N_3/ VREF_3	IO_L40N_3/ VREF_3	IO_L40N_3/ VREF_3	P26	VREF
3	IO_L40P_3	IO_L40P_3	IO_L40P_3	P25	I/O
3	VCCO_3	VCCO_3	VCCO_3	P17	VCCO
3	VCCO_3	VCCO_3	VCCO_3	P18	VCCO
3	VCCO_3	VCCO_3	VCCO_3	R18	VCCO
3	VCCO_3	VCCO_3	VCCO_3	T18	VCCO
3	VCCO_3	VCCO_3	VCCO_3	T24	VCCO
3	VCCO_3	VCCO_3	VCCO_3	U19	VCCO
3	VCCO_3	VCCO_3	VCCO_3	V19	VCCO
3	VCCO_3	VCCO_3	VCCO_3	Y24	VCCO
4	IO	IO	IO	AA20	I/O
4	IO	IO	IO	AD15	I/O
4	N.C. (◆)	IO	IO	AD19	I/O
4	IO	IO	IO	AD23	I/O
4	IO	IO	IO	AF21	I/O
4	IO	IO	IO	AF22	I/O
4	IO	IO	IO	W15	I/O
4	IO	IO	IO	W16	I/O
4	IO/VREF_4	IO/VREF_4	IO/VREF_4	AB14	VREF
4	IO/VREF_4	IO/VREF_4	IO/VREF_4	AD25	VREF
4	IO/VREF_4	IO/VREF_4	IO/VREF_4	Y17	VREF
4	IO_L01N_4/ VRP_4	IO_L01N_4/ VRP_4	IO_L01N_4/ VRP_4	AB22	DCI
4	IO_L01P_4/ VRN_4	IO_L01P_4/ VRN_4	IO_L01P_4/ VRN_4	AC22	DCI
4	IO_L04N_4	IO_L04N_4	IO_L04N_4	AE24	I/O
4	IO_L04P_4	IO_L04P_4	IO_L04P_4	AF24	I/O
4	IO_L05N_4	IO_L05N_4	IO_L05N_4	AE23	I/O
4	IO_L05P_4	IO_L05P_4	IO_L05P_4	AF23	I/O
4	IO_L06N_4/ VREF_4	IO_L06N_4/ VREF_4	IO_L06N_4/ VREF_4	AD22	VREF
4	IO_L06P_4	IO_L06P_4	IO_L06P_4	AE22	I/O
4	IO_L07N_4	IO_L07N_4	IO_L07N_4	AB21	I/O
4	IO_L07P_4	IO_L07P_4	IO_L07P_4	AC21	I/O
4	IO_L08N_4	IO_L08N_4	IO_L08N_4	AD21	I/O
4	IO_L08P_4	IO_L08P_4	IO_L08P_4	AE21	I/O
4	IO_L09N_4	IO_L09N_4	IO_L09N_4	AB20	I/O
4	IO_L09P_4	IO_L09P_4	IO_L09P_4	AC20	I/O
4	IO_L10N_4	IO_L10N_4	IO_L10N_4	AE20	I/O
4	IO_L10P_4	IO_L10P_4	IO_L10P_4	AF20	I/O
4	N.C. (◆)	IO_L11N_4	IO_L11N_4	Y19	I/O
4	N.C. (◆)	IO_L11P_4	IO_L11P_4	AA19	I/O

Table 30: FG676 Package Pinout (Continued)

Bank	XC3S1000 Pin Name	XC3S1500 Pin Name	XC3S2000 Pin Name	FG676 Pin Number	Type
4	N.C. (◆)	IO_L12N_4	IO_L12N_4	AB19	I/O
4	N.C. (◆)	IO_L12P_4	IO_L12P_4	AC19	I/O
4	IO_L15N_4	IO_L15N_4	IO_L15N_4	AE19	I/O
4	IO_L15P_4	IO_L15P_4	IO_L15P_4	AF19	I/O
4	IO_L16N_4	IO_L16N_4	IO_L16N_4	Y18	I/O
4	IO_L16P_4	IO_L16P_4	IO_L16P_4	AA18	I/O
4	N.C. (◆)	IO_L17N_4	IO_L17N_4	AB18	I/O
4	N.C. (◆)	IO_L17P_4	IO_L17P_4	AC18	I/O
4	N.C. (◆)	IO_L18N_4	IO_L18N_4	AD18	I/O
4	N.C. (◆)	IO_L18P_4	IO_L18P_4	AE18	I/O
4	IO_L19N_4	IO_L19N_4	IO_L19N_4	AC17	I/O
4	IO_L19P_4	IO_L19P_4	IO_L19P_4	AA17	I/O
4	IO_L22N_4/ VREF_4	IO_L22N_4/ VREF_4	IO_L22N_4/ VREF_4	AD17	VREF
4	IO_L22P_4	IO_L22P_4	IO_L22P_4	AB17	I/O
4	N.C. (◆)	IO_L23N_4	IO_L23N_4	AE17	I/O
4	N.C. (◆)	IO_L23P_4	IO_L23P_4	AF17	I/O
4	IO_L24N_4	IO_L24N_4	IO_L24N_4	Y16	I/O
4	IO_L24P_4	IO_L24P_4	IO_L24P_4	AA16	I/O
4	IO_L25N_4	IO_L25N_4	IO_L25N_4	AB16	I/O
4	IO_L25P_4	IO_L25P_4	IO_L25P_4	AC16	I/O
4	N.C. (◆)	IO_L26N_4	IO_L26N_4	AE16	I/O
4	N.C. (◆)	IO_L26P_4/ VREF_4	IO_L26P_4/ VREF_4	AF16	VREF
4	IO_L27N_4/ DIN/D0	IO_L27N_4/ DIN/D0	IO_L27N_4/ DIN/D0	Y15	DUAL
4	IO_L27P_4/ D1	IO_L27P_4/ D1	IO_L27P_4/ D1	W14	DUAL
4	IO_L28N_4	IO_L28N_4	IO_L28N_4	AA15	I/O
4	IO_L28P_4	IO_L28P_4	IO_L28P_4	AB15	I/O
4	IO_L29N_4	IO_L29N_4	IO_L29N_4	AE15	I/O
4	IO_L29P_4	IO_L29P_4	IO_L29P_4	AF15	I/O
4	IO_L30N_4/ D2	IO_L30N_4/ D2	IO_L30N_4/ D2	Y14	DUAL
4	IO_L30P_4/ D3	IO_L30P_4/ D3	IO_L30P_4/ D3	AA14	DUAL
4	IO_L31N_4/ INIT_B	IO_L31N_4/ INIT_B	IO_L31N_4/ INIT_B	AC14	DUAL
4	IO_L31P_4/ DOUT/BUSY	IO_L31P_4/ DOUT/BUSY	IO_L31P_4/ DOUT/BUSY	AD14	DUAL
4	IO_L32N_4/ GCLK1	IO_L32N_4/ GCLK1	IO_L32N_4/ GCLK1	AE14	GCLK
4	IO_L32P_4/ GCLK0	IO_L32P_4/ GCLK0	IO_L32P_4/ GCLK0	AF14	GCLK
4	VCCO_4	VCCO_4	VCCO_4	AD16	VCCO
4	VCCO_4	VCCO_4	VCCO_4	AD20	VCCO
4	VCCO_4	VCCO_4	VCCO_4	U14	VCCO
4	VCCO_4	VCCO_4	VCCO_4	V14	VCCO

Table 30: FG676 Package Pinout (Continued)

Bank	XC3S1000 Pin Name	XC3S1500 Pin Name	XC3S2000 Pin Name	FG676 Pin Number	Type
4	VCCO_4	VCCO_4	VCCO_4	V15	VCCO
4	VCCO_4	VCCO_4	VCCO_4	V16	VCCO
4	VCCO_4	VCCO_4	VCCO_4	W17	VCCO
4	VCCO_4	VCCO_4	VCCO_4	W18	VCCO
5	IO	IO	IO	AA7	I/O
5	IO	IO	IO	AA13	I/O
5	IO	IO	IO	AB9	I/O
5	N.C. (◆)	IO	IO	AC9	I/O
5	IO	IO	IO	AC11	I/O
5	IO	IO	IO	AD10	I/O
5	IO	IO	IO	AD12	I/O
5	IO	IO	IO	AF4	I/O
5	IO	IO	IO	Y8	I/O
5	IO/VREF_5	IO/VREF_5	IO/VREF_5	AF5	VREF
5	IO/VREF_5	IO/VREF_5	IO/VREF_5	AF13	VREF
5	IO_L01N_5/ RDWR_B	IO_L01N_5/ RDWR_B	IO_L01N_5/ RDWR_B	AC5	DUAL
5	IO_L01P_5/ CS_B	IO_L01P_5/ CS_B	IO_L01P_5/ CS_B	AB5	DUAL
5	IO_L04N_5	IO_L04N_5	IO_L04N_5	AE4	I/O
5	IO_L04P_5	IO_L04P_5	IO_L04P_5	AD4	I/O
5	IO_L05N_5	IO_L05N_5	IO_L05N_5	AB6	I/O
5	IO_L05P_5	IO_L05P_5	IO_L05P_5	AA6	I/O
5	IO_L06N_5	IO_L06N_5	IO_L06N_5	AE5	I/O
5	IO_L06P_5	IO_L06P_5	IO_L06P_5	AD5	I/O
5	IO_L07N_5	IO_L07N_5	IO_L07N_5	AD6	I/O
5	IO_L07P_5	IO_L07P_5	IO_L07P_5	AC6	I/O
5	IO_L08N_5	IO_L08N_5	IO_L08N_5	AF6	I/O
5	IO_L08P_5	IO_L08P_5	IO_L08P_5	AE6	I/O
5	IO_L09N_5	IO_L09N_5	IO_L09N_5	AC7	I/O
5	IO_L09P_5	IO_L09P_5	IO_L09P_5	AB7	I/O
5	IO_L10N_5/ VRP_5	IO_L10N_5/ VRP_5	IO_L10N_5/ VRP_5	AF7	DCI
5	IO_L10P_5/ VRN_5	IO_L10P_5/ VRN_5	IO_L10P_5/ VRN_5	AE7	DCI
5	N.C. (◆)	IO_L11N_5/ VREF_5	IO_L11N_5/ VREF_5	AB8	VREF
5	N.C. (◆)	IO_L11P_5	IO_L11P_5	AA8	I/O
5	N.C. (◆)	IO_L12N_5	IO_L12N_5	AD8	I/O
5	N.C. (◆)	IO_L12P_5	IO_L12P_5	AC8	I/O
5	IO_L15N_5	IO_L15N_5	IO_L15N_5	AF8	I/O
5	IO_L15P_5	IO_L15P_5	IO_L15P_5	AE8	I/O
5	IO_L16N_5	IO_L16N_5	IO_L16N_5	AA9	I/O
5	IO_L16P_5	IO_L16P_5	IO_L16P_5	Y9	I/O
5	N.C. (◆)	IO_L18N_5	IO_L18N_5	AE9	I/O
5	N.C. (◆)	IO_L18P_5	IO_L18P_5	AD9	I/O
5	IO_L19N_5	IO_L19N_5	IO_L19N_5	AA10	I/O

Table 30: FG676 Package Pinout (Continued)

Bank	XC3S1000 Pin Name	XC3S1500 Pin Name	XC3S2000 Pin Name	FG676 Pin Number	Type
5	IO_L19P_5/ VREF_5	IO_L19P_5/ VREF_5	IO_L19P_5/ VREF_5	Y10	VREF
5	IO_L22N_5	IO_L22N_5	IO_L22N_5	AC10	I/O
5	IO_L22P_5	IO_L22P_5	IO_L22P_5	AB10	I/O
5	N.C. (◆)	IO_L23N_5	IO_L23N_5	AF10	I/O
5	N.C. (◆)	IO_L23P_5	IO_L23P_5	AE10	I/O
5	IO_L24N_5	IO_L24N_5	IO_L24N_5	Y11	I/O
5	IO_L24P_5	IO_L24P_5	IO_L24P_5	W11	I/O
5	IO_L25N_5	IO_L25N_5	IO_L25N_5	AB11	I/O
5	IO_L25P_5	IO_L25P_5	IO_L25P_5	AA11	I/O
5	N.C. (◆)	IO_L26N_5	IO_L26N_5	AF11	I/O
5	N.C. (◆)	IO_L26P_5	IO_L26P_5	AE11	I/O
5	IO_L27N_5/ VREF_5	IO_L27N_5/ VREF_5	IO_L27N_5/ VREF_5	Y12	VREF
5	IO_L27P_5	IO_L27P_5	IO_L27P_5	W12	I/O
5	IO_L28N_5/ D6	IO_L28N_5/ D6	IO_L28N_5/ D6	AB12	DUAL
5	IO_L28P_5/ D7	IO_L28P_5/ D7	IO_L28P_5/ D7	AA12	DUAL
5	IO_L29N_5	IO_L29N_5	IO_L29N_5	AF12	I/O
5	IO_L29P_5/ VREF_5	IO_L29P_5/ VREF_5	IO_L29P_5/ VREF_5	AE12	VREF
5	IO_L30N_5	IO_L30N_5	IO_L30N_5	Y13	I/O
5	IO_L30P_5	IO_L30P_5	IO_L30P_5	W13	I/O
5	IO_L31N_5/ D4	IO_L31N_5/ D4	IO_L31N_5/ D4	AC13	DUAL
5	IO_L31P_5/ D5	IO_L31P_5/ D5	IO_L31P_5/ D5	AB13	DUAL
5	IO_L32N_5/ GCLK3	IO_L32N_5/ GCLK3	IO_L32N_5/ GCLK3	AE13	GCLK
5	IO_L32P_5/ GCLK2	IO_L32P_5/ GCLK2	IO_L32P_5/ GCLK2	AD13	GCLK
5	VCCO_5	VCCO_5	VCCO_5	AD7	VCCO
5	VCCO_5	VCCO_5	VCCO_5	AD11	VCCO
5	VCCO_5	VCCO_5	VCCO_5	U13	VCCO
5	VCCO_5	VCCO_5	VCCO_5	V11	VCCO
5	VCCO_5	VCCO_5	VCCO_5	V12	VCCO
5	VCCO_5	VCCO_5	VCCO_5	V13	VCCO
5	VCCO_5	VCCO_5	VCCO_5	W9	VCCO
5	VCCO_5	VCCO_5	VCCO_5	W10	VCCO
6	N.C. (◆)	N.C. (■)	IO	AA5	I/O
6	IO_L01N_6/ VRP_6	IO_L01N_6/ VRP_6	IO_L01N_6/ VRP_6	AD2	DCI
6	IO_L01P_6/ VRN_6	IO_L01P_6/ VRN_6	IO_L01P_6/ VRN_6	AD1	DCI
6	IO_L02N_6	IO_L02N_6	IO_L02N_6	AB4	I/O
6	IO_L02P_6	IO_L02P_6	IO_L02P_6	AB3	I/O
6	IO_L03N_6/ VREF_6	IO_L03N_6/ VREF_6	IO_L03N_6/ VREF_6	AC2	VREF

Table 30: FG676 Package Pinout (Continued)

Bank	XC3S1000 Pin Name	XC3S1500 Pin Name	XC3S2000 Pin Name	FG676 Pin Number	Type
6	IO_L03P_6	IO_L03P_6	IO_L03P_6	AC1	I/O
6	N.C. (◆)	IO_L05N_6	IO_L05N_6	AB2	I/O
6	N.C. (◆)	IO_L05P_6	IO_L05P_6	AB1	I/O
6	N.C. (◆)	IO_L06N_6	IO_L06N_6	Y7	I/O
6	N.C. (◆)	IO_L06P_6	IO_L06P_6	Y6	I/O
6	N.C. (◆)	IO_L07N_6	IO_L07N_6	AA4	I/O
6	N.C. (◆)	IO_L07P_6	IO_L07P_6	AA3	I/O
6	N.C. (◆)	IO_L08N_6	IO_L08N_6	Y5	I/O
6	N.C. (◆)	IO_L08P_6	IO_L08P_6	Y4	I/O
6	N.C. (◆)	IO_L09N_6/ VREF_6	IO_L09N_6/ VREF_6	AA2	VREF
6	N.C. (◆)	IO_L09P_6	IO_L09P_6	AA1	I/O
6	N.C. (◆)	IO_L10N_6	IO_L10N_6	Y2	I/O
6	N.C. (◆)	IO_L10P_6	IO_L10P_6	Y1	I/O
6	IO_L14N_6	IO_L14N_6	IO_L14N_6	W7	I/O
6	IO_L14P_6	IO_L14P_6	IO_L14P_6	W6	I/O
6	IO_L16N_6	IO_L16N_6	IO_L16N_6	V6	I/O
6	IO_L16P_6	IO_L16P_6	IO_L16P_6	W5	I/O
6	IO_L17N_6	IO_L17N_6	IO_L17N_6	W4	I/O
6	IO_L17P_6/ VREF_6	IO_L17P_6/ VREF_6	IO_L17P_6/ VREF_6	W3	VREF
6	IO_L19N_6	IO_L19N_6	IO_L19N_6	W2	I/O
6	IO_L19P_6	IO_L19P_6	IO_L19P_6	W1	I/O
6	IO_L20N_6	IO_L20N_6	IO_L20N_6	V7	I/O
6	IO_L20P_6	IO_L20P_6	IO_L20P_6	U7	I/O
6	IO_L21N_6	IO_L21N_6	IO_L21N_6	V5	I/O
6	IO_L21P_6	IO_L21P_6	IO_L21P_6	V4	I/O
6	IO_L22N_6	IO_L22N_6	IO_L22N_6	V3	I/O
6	IO_L22P_6	IO_L22P_6	IO_L22P_6	V2	I/O
6	IO_L23N_6	IO_L23N_6	IO_L23N_6	U6	I/O
6	IO_L23P_6	IO_L23P_6	IO_L23P_6	U5	I/O
6	IO_L24N_6/ VREF_6	IO_L24N_6/ VREF_6	IO_L24N_6/ VREF_6	U4	VREF
6	IO_L24P_6	IO_L24P_6	IO_L24P_6	U3	I/O
6	IO_L26N_6	IO_L26N_6	IO_L26N_6	U2	I/O
6	IO_L26P_6	IO_L26P_6	IO_L26P_6	U1	I/O
6	IO_L27N_6	IO_L27N_6	IO_L27N_6	T8	I/O
6	IO_L27P_6	IO_L27P_6	IO_L27P_6	T7	I/O
6	IO_L28N_6	IO_L28N_6	IO_L28N_6	T6	I/O
6	IO_L28P_6	IO_L28P_6	IO_L28P_6	T5	I/O
6	IO_L29N_6	IO_L29N_6	IO_L29N_6	T2	I/O
6	IO_L29P_6	IO_L29P_6	IO_L29P_6	T1	I/O
6	IO_L31N_6	IO_L31N_6	IO_L31N_6	R8	I/O
6	IO_L31P_6	IO_L31P_6	IO_L31P_6	R7	I/O
6	IO_L32N_6	IO_L32N_6	IO_L32N_6	R6	I/O
6	IO_L32P_6	IO_L32P_6	IO_L32P_6	R5	I/O

Table 30: FG676 Package Pinout (Continued)

Bank	XC3S1000 Pin Name	XC3S1500 Pin Name	XC3S2000 Pin Name	FG676 Pin Number	Type
6	IO_L33N_6	IO_L33N_6	IO_L33N_6	T4	I/O
6	IO_L33P_6	IO_L33P_6	IO_L33P_6	R3	I/O
6	IO_L34N_6/ VREF_6	IO_L34N_6/ VREF_6	IO_L34N_6/ VREF_6	R2	VREF
6	IO_L34P_6	IO_L34P_6	IO_L34P_6	R1	I/O
6	IO_L35N_6	IO_L35N_6	IO_L35N_6	P8	I/O
6	IO_L35P_6	IO_L35P_6	IO_L35P_6	P7	I/O
6	IO_L38N_6	IO_L38N_6	IO_L38N_6	P6	I/O
6	IO_L38P_6	IO_L38P_6	IO_L38P_6	P5	I/O
6	IO_L39N_6	IO_L39N_6	IO_L39N_6	P4	I/O
6	IO_L39P_6	IO_L39P_6	IO_L39P_6	P3	I/O
6	IO_L40N_6	IO_L40N_6	IO_L40N_6	P2	I/O
6	IO_L40P_6/ VREF_6	IO_L40P_6/ VREF_6	IO_L40P_6/ VREF_6	P1	VREF
6	VCCO_6	VCCO_6	VCCO_6	P9	VCCO
6	VCCO_6	VCCO_6	VCCO_6	P10	VCCO
6	VCCO_6	VCCO_6	VCCO_6	R9	VCCO
6	VCCO_6	VCCO_6	VCCO_6	T3	VCCO
6	VCCO_6	VCCO_6	VCCO_6	T9	VCCO
6	VCCO_6	VCCO_6	VCCO_6	U8	VCCO
6	VCCO_6	VCCO_6	VCCO_6	V8	VCCO
6	VCCO_6	VCCO_6	VCCO_6	Y3	VCCO
7	IO_L01N_7/ VRP_7	IO_L01N_7/ VRP_7	IO_L01N_7/ VRP_7	F5	DCI
7	IO_L01P_7/ VRN_7	IO_L01P_7/ VRN_7	IO_L01P_7/ VRN_7	F6	DCI
7	IO_L02N_7	IO_L02N_7	IO_L02N_7	E3	I/O
7	IO_L02P_7	IO_L02P_7	IO_L02P_7	E4	I/O
7	IO_L03N_7/ VREF_7	IO_L03N_7/ VREF_7	IO_L03N_7/ VREF_7	D1	VREF
7	IO_L03P_7	IO_L03P_7	IO_L03P_7	D2	I/O
7	N.C. (◆)	IO_L05N_7	IO_L05N_7	G6	I/O
7	N.C. (◆)	IO_L05P_7	IO_L05P_7	G7	I/O
7	N.C. (◆)	IO_L06N_7	IO_L06N_7	E1	I/O
7	N.C. (◆)	IO_L06P_7	IO_L06P_7	E2	I/O
7	N.C. (◆)	IO_L07N_7	IO_L07N_7	F3	I/O
7	N.C. (◆)	IO_L07P_7	IO_L07P_7	F4	I/O
7	N.C. (◆)	IO_L08N_7	IO_L08N_7	G4	I/O
7	N.C. (◆)	IO_L08P_7	IO_L08P_7	G5	I/O
7	N.C. (◆)	IO_L09N_7	IO_L09N_7	F1	I/O
7	N.C. (◆)	IO_L09P_7	IO_L09P_7	F2	I/O
7	N.C. (◆)	IO_L10N_7	IO_L10N_7	H6	I/O
7	N.C. (◆)	IO_L10P_7/ VREF_7	IO_L10P_7/ VREF_7	H7	VREF
7	IO_L14N_7	IO_L14N_7	IO_L14N_7	G1	I/O
7	IO_L14P_7	IO_L14P_7	IO_L14P_7	G2	I/O
7	IO_L16N_7	IO_L16N_7	IO_L16N_7	J6	I/O

Table 30: FG676 Package Pinout (Continued)

Bank	XC3S1000 Pin Name	XC3S1500 Pin Name	XC3S2000 Pin Name	FG676 Pin Number	Type
7	IO_L16P_7/ VREF_7	IO_L16P_7/ VREF_7	IO_L16P_7/ VREF_7	H5	VREF
7	IO_L17N_7	IO_L17N_7	IO_L17N_7	H3	I/O
7	IO_L17P_7	IO_L17P_7	IO_L17P_7	H4	I/O
7	IO_L19N_7/ VREF_7	IO_L19N_7/ VREF_7	IO_L19N_7/ VREF_7	H1	VREF
7	IO_L19P_7	IO_L19P_7	IO_L19P_7	H2	I/O
7	IO_L20N_7	IO_L20N_7	IO_L20N_7	K7	I/O
7	IO_L20P_7	IO_L20P_7	IO_L20P_7	J7	I/O
7	IO_L21N_7	IO_L21N_7	IO_L21N_7	J4	I/O
7	IO_L21P_7	IO_L21P_7	IO_L21P_7	J5	I/O
7	IO_L22N_7	IO_L22N_7	IO_L22N_7	J2	I/O
7	IO_L22P_7	IO_L22P_7	IO_L22P_7	J3	I/O
7	IO_L23N_7	IO_L23N_7	IO_L23N_7	K5	I/O
7	IO_L23P_7	IO_L23P_7	IO_L23P_7	K6	I/O
7	IO_L24N_7	IO_L24N_7	IO_L24N_7	K3	I/O
7	IO_L24P_7	IO_L24P_7	IO_L24P_7	K4	I/O
7	IO_L26N_7	IO_L26N_7	IO_L26N_7	K1	I/O
7	IO_L26P_7	IO_L26P_7	IO_L26P_7	K2	I/O
7	IO_L27N_7	IO_L27N_7	IO_L27N_7	L7	I/O
7	IO_L27P_7/ VREF_7	IO_L27P_7/ VREF_7	IO_L27P_7/ VREF_7	L8	VREF
7	IO_L28N_7	IO_L28N_7	IO_L28N_7	L5	I/O
7	IO_L28P_7	IO_L28P_7	IO_L28P_7	L6	I/O
7	IO_L29N_7	IO_L29N_7	IO_L29N_7	L1	I/O
7	IO_L29P_7	IO_L29P_7	IO_L29P_7	L2	I/O
7	IO_L31N_7	IO_L31N_7	IO_L31N_7	M7	I/O
7	IO_L31P_7	IO_L31P_7	IO_L31P_7	M8	I/O
7	IO_L32N_7	IO_L32N_7	IO_L32N_7	M6	I/O
7	IO_L32P_7	IO_L32P_7	IO_L32P_7	M5	I/O
7	IO_L33N_7	IO_L33N_7	IO_L33N_7	M3	I/O
7	IO_L33P_7	IO_L33P_7	IO_L33P_7	L4	I/O
7	IO_L34N_7	IO_L34N_7	IO_L34N_7	M1	I/O
7	IO_L34P_7	IO_L34P_7	IO_L34P_7	M2	I/O
7	IO_L35N_7	IO_L35N_7	IO_L35N_7	N7	I/O
7	IO_L35P_7	IO_L35P_7	IO_L35P_7	N8	I/O
7	IO_L38N_7	IO_L38N_7	IO_L38N_7	N5	I/O
7	IO_L38P_7	IO_L38P_7	IO_L38P_7	N6	I/O
7	IO_L39N_7	IO_L39N_7	IO_L39N_7	N3	I/O
7	IO_L39P_7	IO_L39P_7	IO_L39P_7	N4	I/O
7	IO_L40N_7/ VREF_7	IO_L40N_7/ VREF_7	IO_L40N_7/ VREF_7	N1	VREF
7	IO_L40P_7	IO_L40P_7	IO_L40P_7	N2	I/O
7	VCCO_7	VCCO_7	VCCO_7	G3	VCCO
7	VCCO_7	VCCO_7	VCCO_7	J8	VCCO
7	VCCO_7	VCCO_7	VCCO_7	K8	VCCO



Table 30: FG676 Package Pinout (Continued)

Bank	XC3S1000 Pin Name	XC3S1500 Pin Name	XC3S2000 Pin Name	FG676 Pin Number	Type
7	VCCO_7	VCCO_7	VCCO_7	L3	VCCO
7	VCCO_7	VCCO_7	VCCO_7	L9	VCCO
7	VCCO_7	VCCO_7	VCCO_7	M9	VCCO
7	VCCO_7	VCCO_7	VCCO_7	N9	VCCO
7	VCCO_7	VCCO_7	VCCO_7	N10	VCCO
N/A	GND	GND	GND	A1	GND
N/A	GND	GND	GND	A26	GND
N/A	GND	GND	GND	AC4	GND
N/A	GND	GND	GND	AC12	GND
N/A	GND	GND	GND	AC15	GND
N/A	GND	GND	GND	AC23	GND
N/A	GND	GND	GND	AD3	GND
N/A	GND	GND	GND	AD24	GND
N/A	GND	GND	GND	AE2	GND
N/A	GND	GND	GND	AE25	GND
N/A	GND	GND	GND	AF1	GND
N/A	GND	GND	GND	AF26	GND
N/A	GND	GND	GND	B2	GND
N/A	GND	GND	GND	B25	GND
N/A	GND	GND	GND	C3	GND
N/A	GND	GND	GND	C24	GND
N/A	GND	GND	GND	D4	GND
N/A	GND	GND	GND	D12	GND
N/A	GND	GND	GND	D15	GND
N/A	GND	GND	GND	D23	GND
N/A	GND	GND	GND	K11	GND
N/A	GND	GND	GND	K12	GND
N/A	GND	GND	GND	K15	GND
N/A	GND	GND	GND	K16	GND
N/A	GND	GND	GND	L10	GND
N/A	GND	GND	GND	L11	GND
N/A	GND	GND	GND	L12	GND
N/A	GND	GND	GND	L13	GND
N/A	GND	GND	GND	L14	GND
N/A	GND	GND	GND	L15	GND
N/A	GND	GND	GND	L16	GND
N/A	GND	GND	GND	L17	GND
N/A	GND	GND	GND	M4	GND
N/A	GND	GND	GND	M10	GND
N/A	GND	GND	GND	M11	GND
N/A	GND	GND	GND	M12	GND
N/A	GND	GND	GND	M13	GND
N/A	GND	GND	GND	M14	GND
N/A	GND	GND	GND	M15	GND
N/A	GND	GND	GND	M16	GND

Table 30: FG676 Package Pinout (Continued)

Bank	XC3S1000 Pin Name	XC3S1500 Pin Name	XC3S2000 Pin Name	FG676 Pin Number	Type
N/A	GND	GND	GND	M17	GND
N/A	GND	GND	GND	M23	GND
N/A	GND	GND	GND	N11	GND
N/A	GND	GND	GND	N12	GND
N/A	GND	GND	GND	N13	GND
N/A	GND	GND	GND	N14	GND
N/A	GND	GND	GND	N15	GND
N/A	GND	GND	GND	N16	GND
N/A	GND	GND	GND	P11	GND
N/A	GND	GND	GND	P12	GND
N/A	GND	GND	GND	P13	GND
N/A	GND	GND	GND	P14	GND
N/A	GND	GND	GND	P15	GND
N/A	GND	GND	GND	P16	GND
N/A	GND	GND	GND	R4	GND
N/A	GND	GND	GND	R10	GND
N/A	GND	GND	GND	R11	GND
N/A	GND	GND	GND	R12	GND
N/A	GND	GND	GND	R13	GND
N/A	GND	GND	GND	R14	GND
N/A	GND	GND	GND	R15	GND
N/A	GND	GND	GND	R16	GND
N/A	GND	GND	GND	R17	GND
N/A	GND	GND	GND	R23	GND
N/A	GND	GND	GND	T10	GND
N/A	GND	GND	GND	T11	GND
N/A	GND	GND	GND	T12	GND
N/A	GND	GND	GND	T13	GND
N/A	GND	GND	GND	T14	GND
N/A	GND	GND	GND	T15	GND
N/A	GND	GND	GND	T16	GND
N/A	GND	GND	GND	T17	GND
N/A	GND	GND	GND	U11	GND
N/A	GND	GND	GND	U12	GND
N/A	GND	GND	GND	U15	GND
N/A	GND	GND	GND	U16	GND
N/A	VCCAUX	VCCAUX	VCCAUX	A2	VCCAUX
N/A	VCCAUX	VCCAUX	VCCAUX	A9	VCCAUX
N/A	VCCAUX	VCCAUX	VCCAUX	A18	VCCAUX
N/A	VCCAUX	VCCAUX	VCCAUX	A25	VCCAUX
N/A	VCCAUX	VCCAUX	VCCAUX	AE1	VCCAUX
N/A	VCCAUX	VCCAUX	VCCAUX	AE26	VCCAUX
N/A	VCCAUX	VCCAUX	VCCAUX	AF2	VCCAUX
N/A	VCCAUX	VCCAUX	VCCAUX	AF9	VCCAUX
N/A	VCCAUX	VCCAUX	VCCAUX	AF18	VCCAUX

Table 30: FG676 Package Pinout (Continued)

Bank	XC3S1000 Pin Name	XC3S1500 Pin Name	XC3S2000 Pin Name	FG676 Pin Number	Type
N/A	VCCAUX	VCCAUX	VCCAUX	AF25	VCCAUX
N/A	VCCAUX	VCCAUX	VCCAUX	B1	VCCAUX
N/A	VCCAUX	VCCAUX	VCCAUX	B26	VCCAUX
N/A	VCCAUX	VCCAUX	VCCAUX	J1	VCCAUX
N/A	VCCAUX	VCCAUX	VCCAUX	J26	VCCAUX
N/A	VCCAUX	VCCAUX	VCCAUX	V1	VCCAUX
N/A	VCCAUX	VCCAUX	VCCAUX	V26	VCCAUX
N/A	VCCINT	VCCINT	VCCINT	H8	VCCINT
N/A	VCCINT	VCCINT	VCCINT	H19	VCCINT
N/A	VCCINT	VCCINT	VCCINT	J9	VCCINT
N/A	VCCINT	VCCINT	VCCINT	J10	VCCINT
N/A	VCCINT	VCCINT	VCCINT	J17	VCCINT
N/A	VCCINT	VCCINT	VCCINT	J18	VCCINT
N/A	VCCINT	VCCINT	VCCINT	K9	VCCINT
N/A	VCCINT	VCCINT	VCCINT	K10	VCCINT
N/A	VCCINT	VCCINT	VCCINT	K17	VCCINT
N/A	VCCINT	VCCINT	VCCINT	K18	VCCINT
N/A	VCCINT	VCCINT	VCCINT	U9	VCCINT
N/A	VCCINT	VCCINT	VCCINT	U10	VCCINT
N/A	VCCINT	VCCINT	VCCINT	U17	VCCINT
N/A	VCCINT	VCCINT	VCCINT	U18	VCCINT
N/A	VCCINT	VCCINT	VCCINT	V9	VCCINT
N/A	VCCINT	VCCINT	VCCINT	V10	VCCINT
N/A	VCCINT	VCCINT	VCCINT	V17	VCCINT
N/A	VCCINT	VCCINT	VCCINT	V18	VCCINT
N/A	VCCINT	VCCINT	VCCINT	W8	VCCINT
N/A	VCCINT	VCCINT	VCCINT	W19	VCCINT
VCC AUX	CCLK	CCLK	CCLK	AD26	CONFIG

Table 31: User I/Os Per Bank for XC3S1000 in FG676 Package

Edge	I/O Bank	Maximum I/O	All Possible I/O Pins by Type				
			I/O	DUAL	DCI	VREF	GCLK
Top	0	49	40	0	2	5	2
	1	50	41	0	2	5	2
Right	2	48	41	0	2	5	0
	3	48	41	0	2	5	0
Bottom	4	50	35	6	2	5	2
	5	50	35	6	2	5	2
Left	6	48	41	0	2	5	0
	7	48	41	0	2	5	0

Table 30: FG676 Package Pinout (Continued)

Bank	XC3S1000 Pin Name	XC3S1500 Pin Name	XC3S2000 Pin Name	FG676 Pin Number	Type
VCC AUX	DONE	DONE	DONE	AC24	CONFIG
VCC AUX	HSWAP_EN	HSWAP_EN	HSWAP_EN	C2	CONFIG
VCC AUX	M0	M0	M0	AE3	CONFIG
VCC AUX	M1	M1	M1	AC3	CONFIG
VCC AUX	M2	M2	M2	AF3	CONFIG
VCC AUX	PROG_B	PROG_B	PROG_B	D3	CONFIG
VCC AUX	TCK	TCK	TCK	B24	JTAG
VCC AUX	TDI	TDI	TDI	C1	JTAG
VCC AUX	TDO	TDO	TDO	D24	JTAG
VCC AUX	TMS	TMS	TMS	A24	JTAG

### User I/Os by Bank

Table 31 indicates how the available user-I/O pins are distributed between the eight I/O banks for the XC3S1000 in the FG676 package. Similarly, Table 32 shows how the available user-I/O pins are distributed between the eight I/O banks for the XC3S1500 in the FG676 package. Finally, Table 33 shows the same information for the XC3S2000 in the FG676 package.

Table 32: User I/Os Per Bank for XC3S1500 in FG676 Package

Edge	I/O Bank	Maximum I/O	All Possible I/O Pins by Type				
			I/O	DUAL	DCI	VREF	GCLK
Top	0	62	52	0	2	6	2
	1	61	51	0	2	6	2
Right	2	60	52	0	2	6	0
	3	60	52	0	2	6	0
Bottom	4	63	47	6	2	6	2
	5	61	45	6	2	6	2
Left	6	60	52	0	2	6	0
	7	60	52	0	2	6	0

Table 33: User I/Os Per Bank for XC3S2000 in FG676 Package

Edge	I/O Bank	Maximum I/O	All Possible I/O Pins by Type				
			I/O	DUAL	DCI	VREF	GCLK
Top	0	62	52	0	2	6	2
	1	61	51	0	2	6	2
Right	2	61	53	0	2	6	0
	3	60	52	0	2	6	0
Bottom	4	63	47	6	2	6	2
	5	61	45	6	2	6	2
Left	6	61	53	0	2	6	0
	7	60	52	0	2	6	0

### FG676 Footprint

#### Left Half of Package (top view)

##### XC3S1000

(391 max. user I/O)

**315** I/O: Unrestricted, general-purpose user I/O

**40** VREF: User I/O or input voltage reference for bank

**98** N.C.: Unconnected pins for XC3S1000 (◆)

##### XC3S1500

(487 max user I/O)

**403** I/O: Unrestricted, general-purpose user I/O

**48** VREF: User I/O or input voltage reference for bank

**2** N.C.: Unconnected pins for XC3S1500 (■)

##### XC3S2000

(489 max user I/O)

**405** I/O: Unrestricted, general-purpose user I/O

**48** VREF: User I/O or input voltage reference for bank

**0** N.C.: No unconnected pins

##### All devices

**12** DUAL: Configuration pin, then possible user I/O

**8** GCLK: User I/O or global clock buffer input

**16** DCI: User I/O or reference resistor input for bank

**7** CONFIG: Dedicated configuration pins

**4** JTAG: Dedicated JTAG port pins

**20** VCCINT: Internal core voltage supply (+1.2V)

**64** VCCO: Output voltage supply for bank

**16** VCCAUX: Auxiliary voltage supply (+2.5V)

**76** GND: Ground

		Bank 0													
		1	2	3	4	5	6	7	8	9	10	11	12	13	
Bank 7	A	GND	VCCAUX	I/O	I/O L05P_0 VREF_0	I/O	I/O	I/O L10P_0	I/O L15P_0	VCCAUX	I/O L23P_0	I/O L26P_0 VREF_0	I/O L29P_0	I/O L32P_0 GCLK6	
	B	VCCAUX	GND	I/O VREF_0	I/O L05N_0	I/O L06P_0	I/O L08P_0	I/O L10N_0	I/O L15N_0	I/O L18P_0	I/O L23N_0	I/O L26N_0	I/O L29N_0	I/O L32N_0 GCLK7	
	C	TDI	HSWAP_EN	GND	I/O	I/O L06N_0	I/O L08N_0	VCCO_0	I/O	I/O L18N_0	I/O L22P_0	VCCO_0	I/O	I/O L31P_0 VREF_0	
	D	I/O L03N_7 VREF_7	I/O L03P_7	PROG_B	GND	I/O L01P_0 VRN_0	I/O L07P_0	I/O L09P_0	I/O L12P_0	I/O L17P_0	I/O L22N_0	I/O L25P_0	GND	I/O L31N_0	
	E	I/O L06N_7	I/O L06P_7	I/O L02N_7	I/O L02P_7	I/O L01N_0 VRP_0	I/O L07N_0	I/O L09N_0	I/O L12N_0	I/O L17N_0	I/O L19P_0	I/O L25N_0	I/O L28P_0	I/O	
	F	I/O L09N_7	I/O L09P_7	I/O L07N_7	I/O L07P_7	I/O L01N_7 VRP_7	I/O L01P_7 VRN_7	I/O VREF_0	I/O L11P_0	I/O L16P_0	I/O L19N_0	I/O L24P_0	I/O L28N_0	I/O L30P_0	
	G	I/O L14N_7	I/O L14P_7	VCCO_7	I/O L08N_7	I/O L08P_7	I/O L05N_7	I/O L05P_7	I/O L11N_0	I/O L16N_0	I/O VREF_0	I/O L24N_0	I/O L27N_0	I/O L30N_0	
	H	I/O L19N_7 VREF_7	I/O L19P_7	I/O L17N_7	I/O L17P_7	I/O L16P_7 VREF_7	I/O L10N_7	I/O L10P_7 VREF_7	VCCINT	VCCO_0	VCCO_0	I/O	I/O	I/O L27P_0	
	J	VCCAUX	I/O L22N_7	I/O L22P_7	I/O L21N_7	I/O L21P_7	I/O L16N_7	I/O L20P_7	VCCO_7	VCCINT	VCCINT	VCCO_0	VCCO_0	VCCO_0	
	K	I/O L26N_7	I/O L26P_7	I/O L24N_7	I/O L24P_7	I/O L23N_7	I/O L23P_7	I/O L20N_7	VCCO_7	VCCINT	VCCINT	GND	GND	VCCO_0	
	L	I/O L29N_7	I/O L29P_7	VCCO_7	I/O L33P_7	I/O L28N_7	I/O L28P_7	I/O L27N_7	I/O L27P_7 VREF_7	VCCO_7	GND	GND	GND	GND	
	M	I/O L34N_7	I/O L34P_7	I/O L33N_7	GND	I/O L32P_7	I/O L32N_7	I/O L31N_7	I/O L31P_7	VCCO_7	GND	GND	GND	GND	
	N	I/O L40N_7 VREF_7	I/O L40P_7	I/O L39N_7	I/O L39P_7	I/O L38N_7	I/O L38P_7	I/O L35N_7	I/O L35P_7	VCCO_7	VCCO_7	GND	GND	GND	
	P	I/O L40P_6 VREF_6	I/O L40N_6	I/O L39P_6	I/O L39N_6	I/O L38P_6	I/O L38N_6	I/O L35P_6	I/O L35N_6	VCCO_6	VCCO_6	GND	GND	GND	
	R	I/O L34P_6	I/O L34N_6 VREF_6	I/O L33P_6	GND	I/O L32P_6	I/O L32N_6	I/O L31P_6	I/O L31N_6	VCCO_6	GND	GND	GND	GND	
	T	I/O L29P_6	I/O L29N_6	VCCO_6	I/O L33N_6	I/O L28P_6	I/O L28N_6	I/O L27P_6	I/O L27N_6	VCCO_6	GND	GND	GND	GND	
U	I/O L26P_6	I/O L26N_6	I/O L24P_6	I/O L24N_6 VREF_6	I/O L23P_6	I/O L23N_6	I/O L20P_6	I/O L20P_6	VCCO_6	VCCINT	VCCINT	GND	GND	VCCO_5	
V	VCCAUX	I/O L22P_6	I/O L22N_6	I/O L21P_6	I/O L21N_6	I/O L16N_6	I/O L20N_6	VCCO_6	VCCINT	VCCINT	VCCO_5	VCCO_5	VCCO_5		
W	I/O L19P_6	I/O L19N_6	I/O L17P_6 VREF_6	I/O L17N_6	I/O L16P_6	I/O L14P_6	I/O L14N_6	VCCINT	VCCO_5	VCCO_5	I/O L24P_5	I/O L27P_5	I/O L30P_5		
Y	I/O L10P_6	I/O L10N_6	VCCO_6	I/O L08P_6	I/O L08N_6	I/O L06P_6	I/O L06N_6	I/O	I/O L16P_5	I/O L19P_5 VREF_5	I/O L24N_5	I/O L27N_5 VREF_5	I/O L30N_5		
Bank 6	A	I/O L09P_6	I/O L09N_6 VREF_6	I/O L07P_6	I/O L07N_6	I/O	I/O L05P_5	I/O	I/O L11P_5	I/O L16N_5	I/O L19N_5	I/O L25P_5	I/O L28P_5 D7	I/O	
	A	I/O L05P_6	I/O L05N_6	I/O L02P_6	I/O L02N_6	I/O L01P_5 CS_B	I/O L05N_5	I/O L09P_5	I/O L11N_5 VREF_5	I/O	I/O L22P_5	I/O L25N_5	I/O L28N_5 D6	I/O L31P_5 D5	
	A	I/O L03P_6	I/O L03N_6 VREF_6	M1	GND	I/O L01N_5 RDWR_B	I/O L07P_5	I/O L09N_5	I/O L12P_5	I/O	I/O L22N_5	I/O	GND	I/O L31N_5 D4	
	A	I/O L01P_6 VRN_6	I/O L01N_6 VRP_6	GND	I/O L04P_5	I/O L06P_5	I/O L07N_5	VCCO_5	I/O L12N_5	I/O L18P_5	I/O	VCCO_5	I/O	I/O L32P_5 GCLK2	
	A	VCCAUX	GND	M0	I/O L04N_5	I/O L06N_5	I/O L08P_5	I/O L10P_5 VRN_5	I/O L15P_5	I/O L18N_5	I/O L23P_5	I/O L26P_5	I/O L29P_5 VREF_5	I/O L32N_5 GCLK3	
	A	GND	VCCAUX	M2	I/O	I/O VREF_5	I/O L08N_5	I/O L10N_5 VRP_5	I/O L15N_5	VCCAUX	I/O L23N_5	I/O L26N_5	I/O L29N_5	I/O VREF_5	
			Bank 5												

Figure 14: FG676 Package Footprint (top view)

DS099-4\_12a\_030203

Bank 1														Bank 2			Bank 3			Bank 4													
14	15	16	17	18	19	20	21	22	23	24	25	26																					
I/O	I/O L29N_1	I/O L26N_1	I/O L23N_1	VCCAUX	I/O L15N_1	I/O L10N_1 VREF_1	I/O L08N_1	I/O	I/O	TMS	VCCAUX	GND	A																				
I/O L32N_1 GCLK6	I/O L29P_1	I/O L26P_1	I/O L23P_1	I/O L18N_1	I/O L15P_1	I/O L10P_1	I/O L08P_1	I/O L06N_1 VREF_1	I/O L04N_1	TCK	GND	VCCAUX	B																				
I/O L32P_1 GCLK4	I/O VREF_1	VCCO_1	I/O VREF_1	I/O L18P_1	I/O L12N_1	VCCO_1	I/O L07N_1	I/O L06P_1	I/O L04P_1	GND	I/O L01N_2 VRF_2	I/O L01P_2 VRN_2	C																				
I/O L31N_1 VREF_1	GND	I/O	I/O L22N_1	I/O VREF_1	I/O L12P_1	I/O L09N_1	I/O L07P_1	I/O L01N_1 VRF_1	GND	TDO	I/O L03N_2 VREF_2	I/O L03P_2	D																				
I/O L31P_1	I/O L28N_1	I/O L25N_1	I/O L22P_1	I/O	I/O L11N_1	I/O L09P_1	I/O L05N_1	I/O L01P_1 VRN_1	I/O L02N_2	I/O L02P_2	I/O L05N_2	I/O L05P_2	E																				
I/O	I/O L28P_1	I/O L25P_1	I/O L19N_1	I/O L16N_1	I/O L11P_1	I/O	I/O L05P_1	I/O	I/O L07N_2	I/O L07P_2	I/O L09N_2 VREF_2	I/O L09P_2	F																				
I/O L30N_1	I/O L27N_1	I/O L24N_1	I/O L19P_1	I/O L16P_1	I/O	I/O L06N_2	I/O L06P_2	I/O L08N_2	I/O L08P_2	VCCO_2	I/O L10N_2	I/O L10P_2	G																				
I/O L30P_1	I/O L27P_1	I/O L24P_1	VCCO_1	VCCO_1	VCCINT	I/O L14N_2	I/O L14P_2	I/O L16N_2	I/O L17N_2	I/O L17P_2 VREF_2	I/O L19N_2	I/O L19P_2	H																				
VCCO_1	VCCO_1	VCCO_1	VCCO_1	VCCO_1	VCCO_1	VCCO_2	I/O L20N_2	I/O L16P_2	I/O L21N_2	I/O L21P_2	I/O L22N_2	I/O L22P_2	VCCAUX	J																			
VCCO_1	GND	GND	VCCO_1	VCCO_1	VCCO_2	I/O L20P_2	I/O L23N_2 VREF_2	I/O L23P_2	I/O L24N_2	I/O L24P_2	I/O L26N_2	I/O L26P_2	K																				
GND	GND	GND	GND	VCCO_2	I/O L27N_2	I/O L27P_2	I/O L28N_2	I/O L28P_2	I/O L33N_2	VCCO_2	I/O L29N_2	I/O L29P_2	L																				
GND	GND	GND	GND	VCCO_2	I/O L31N_2	I/O L31P_2	I/O L32N_2	I/O L32P_2	GND	I/O L33P_2	I/O L34N_2 VREF_2	I/O L34P_2	M																				
GND	GND	GND	VCCO_2	VCCO_2	I/O L35N_2	I/O L35P_2	I/O L38N_2	I/O L38P_2	I/O L39N_2	I/O L39P_2	I/O L40N_2	I/O L40P_2 VREF_2	N																				
GND	GND	GND	VCCO_3	VCCO_3	I/O L35P_3	I/O L35N_3	I/O L38P_3	I/O L38N_3	I/O L39P_3	I/O L39N_3	I/O L40P_3	I/O L40N_3 VREF_3	P																				
GND	GND	GND	GND	VCCO_3	I/O L31P_3	I/O L31N_3	I/O L32P_3	I/O L32N_3	GND	I/O L33N_3	I/O L34P_3 VREF_3	I/O L34N_3	R																				
GND	GND	GND	GND	VCCO_3	I/O L27P_3	I/O L27N_3	I/O L28P_3	I/O L28N_3	I/O L33P_3	VCCO_3	I/O L29P_3	I/O L29N_3	T																				
VCCO_4	GND	GND	VCCO_4	VCCO_4	VCCO_3	I/O L20N_3	I/O L23P_3 VREF_3	I/O L23N_3	I/O L24P_3	I/O L24N_3	I/O L26P_3	I/O L26N_3	U																				
VCCO_4	VCCO_4	VCCO_4	VCCO_4	VCCO_4	VCCO_3	I/O L20P_3	I/O L16N_3	I/O L21P_3	I/O L21N_3	I/O L22P_3	I/O L22N_3	VCCAUX	V																				
I/O L27P_4 D1	I/O	I/O	VCCO_4	VCCO_4	VCCO_3	I/O L10P_3	I/O L10N_3	I/O L16P_3	I/O L17P_3 VREF_3	I/O L17N_3	I/O L19P_3	I/O L19N_3	W																				
I/O L30N_4 D2	I/O L27N_4 DIN D0	I/O L24N_4	I/O VREF_4	I/O L16N_4	I/O L11N_4	I/O L05P_3	I/O L05N_3	I/O L08P_3	I/O L08N_3	VCCO_3	I/O L14P_3	I/O L14N_3	Y																				
I/O L30P_4 D3	I/O L28N_4	I/O L24P_4	I/O L19P_4	I/O L16P_4	I/O L11P_4	I/O	I/O L01P_3 VRN_3	I/O L01N_3 VRF_3	I/O L07P_3	I/O L07N_3	I/O L09P_3 VREF_3	I/O L09N_3	AA																				
I/O VREF_4	I/O L28P_4	I/O L25N_4	I/O L22P_4	I/O L17N_4	I/O L12N_4	I/O L09N_4	I/O L07N_4	I/O L01N_4 VRF_4	I/O L02P_3	I/O L02N_3 VREF_3	I/O L06P_3	I/O L06N_3	AB																				
I/O L31N_4 INIT_B	GND	I/O L25P_4	I/O L19N_4	I/O L17P_4	I/O L12P_4	I/O L09P_4	I/O L07P_4	I/O L01P_4 VRN_4	GND	DONE	I/O L03P_3	I/O L03N_3	AC																				
I/O L31P_4 DOUT BUSY	I/O	VCCO_4	I/O L22N_4 VREF_4	I/O L18N_4	I/O	VCCO_4	I/O L08N_4	I/O L06N_4 VREF_4	I/O	GND	I/O VREF_4	CCLK	AD																				
I/O L32N_4 GCLK1	I/O L29N_4	I/O L26N_4	I/O L23N_4	I/O L18P_4	I/O L15N_4	I/O L10N_4	I/O L08P_4	I/O L06P_4	I/O L05N_4	I/O L04N_4	GND	VCCAUX	AE																				
I/O L32P_4 GCLK0	I/O L29P_4	I/O L26P_4 VREF_4	I/O L23P_4	VCCAUX	I/O L15P_4	I/O L10P_4	I/O	I/O	I/O L05P_4	I/O L04P_4	VCCAUX	GND	AF																				

Right Half of Package (top view)

DS099-4\_12b\_121103

## FG900: 900-lead Fine-pitch Ball Grid Array

The 900-lead fine-pitch ball grid array package, FG900, supports three different Spartan-3 devices, including the XC3S2000, the XC3S4000, and the XC3S5000. The footprints for the XC3S4000 and XC3S5000 are identical, as shown in [Table 34](#) and [Figure 15](#). The XC3S2000, however, has fewer I/O pins which consequently results in 68 unconnected pins on the FG900 package, labeled as “N.C.” In [Table 34](#) and [Figure 15](#), these unconnected pins are indicated with a black diamond symbol (◆).

All the package pins appear in [Table 34](#) and are sorted by bank number, then by pin name. Pairs of pins that form a differential I/O pair appear together in the table. The table also shows the pin number for each pin and the pin type, as defined earlier.

If there is a difference between the XC3S2000 pinout and the pinout for the XC3S4000 and XC3S5000, then that difference is highlighted in [Table 34](#). If the table entry is shaded, then there is an unconnected pin on the XC3S2000 that maps to a user-I/O pin on the XC3S4000 and XC3S5000.

### Pinout Table

Table 34: FG900 Package Pinout

Bank	XC3S2000 Pin Name	XC3S4000 XC3S5000 Pin Name	FG900 Pin Number	Type
0	IO	IO	E15	I/O
0	IO	IO	K15	I/O
0	IO	IO	D13	I/O
0	IO	IO	K13	I/O
0	IO	IO	G8	I/O
0	IO/VREF_0	IO/VREF_0	F9	VREF
0	IO/VREF_0	IO/VREF_0	C4	VREF
0	IO_L01N_0/ VRP_0	IO_L01N_0/ VRP_0	B4	DCI
0	IO_L01P_0/ VRN_0	IO_L01P_0/ VRN_0	A4	DCI
0	IO_L02N_0	IO_L02N_0	B5	I/O
0	IO_L02P_0	IO_L02P_0	A5	I/O
0	IO_L03N_0	IO_L03N_0	D5	I/O
0	IO_L03P_0	IO_L03P_0	E6	I/O
0	IO_L04N_0	IO_L04N_0	C6	I/O
0	IO_L04P_0	IO_L04P_0	B6	I/O
0	IO_L05N_0	IO_L05N_0	F6	I/O
0	IO_L05P_0/ VREF_0	IO_L05P_0/ VREF_0	F7	VREF
0	IO_L06N_0	IO_L06N_0	D7	I/O
0	IO_L06P_0	IO_L06P_0	C7	I/O
0	IO_L07N_0	IO_L07N_0	F8	I/O

Table 34: FG900 Package Pinout (Continued)

Bank	XC3S2000 Pin Name	XC3S4000 XC3S5000 Pin Name	FG900 Pin Number	Type
0	IO_L07P_0	IO_L07P_0	E8	I/O
0	IO_L08N_0	IO_L08N_0	D8	I/O
0	IO_L08P_0	IO_L08P_0	C8	I/O
0	IO_L09N_0	IO_L09N_0	B8	I/O
0	IO_L09P_0	IO_L09P_0	A8	I/O
0	IO_L10N_0	IO_L10N_0	J9	I/O
0	IO_L10P_0	IO_L10P_0	H9	I/O
0	IO_L11N_0	IO_L11N_0	G10	I/O
0	IO_L11P_0	IO_L11P_0	F10	I/O
0	IO_L12N_0	IO_L12N_0	C10	I/O
0	IO_L12P_0	IO_L12P_0	B10	I/O
0	IO_L13N_0	IO_L13N_0	J10	I/O
0	IO_L13P_0	IO_L13P_0	K11	I/O
0	IO_L14N_0	IO_L14N_0	H11	I/O
0	IO_L14P_0	IO_L14P_0	G11	I/O
0	IO_L15N_0	IO_L15N_0	F11	I/O
0	IO_L15P_0	IO_L15P_0	E11	I/O
0	IO_L16N_0	IO_L16N_0	D11	I/O
0	IO_L16P_0	IO_L16P_0	C11	I/O
0	IO_L17N_0	IO_L17N_0	B11	I/O
0	IO_L17P_0	IO_L17P_0	A11	I/O
0	IO_L18N_0	IO_L18N_0	K12	I/O
0	IO_L18P_0	IO_L18P_0	J12	I/O
0	IO_L19N_0	IO_L19N_0	H12	I/O
0	IO_L19P_0	IO_L19P_0	G12	I/O
0	IO_L20N_0	IO_L20N_0	F12	I/O
0	IO_L20P_0	IO_L20P_0	E12	I/O
0	IO_L21N_0	IO_L21N_0	D12	I/O
0	IO_L21P_0	IO_L21P_0	C12	I/O
0	IO_L22N_0	IO_L22N_0	B12	I/O
0	IO_L22P_0	IO_L22P_0	A12	I/O
0	IO_L23N_0	IO_L23N_0	J13	I/O
0	IO_L23P_0	IO_L23P_0	H13	I/O
0	IO_L24N_0	IO_L24N_0	F13	I/O
0	IO_L24P_0	IO_L24P_0	E13	I/O
0	IO_L25N_0	IO_L25N_0	B13	I/O
0	IO_L25P_0	IO_L25P_0	A13	I/O
0	IO_L26N_0	IO_L26N_0	K14	I/O
0	IO_L26P_0/ VREF_0	IO_L26P_0/ VREF_0	J14	VREF
0	IO_L27N_0	IO_L27N_0	G14	I/O
0	IO_L27P_0	IO_L27P_0	F14	I/O
0	IO_L28N_0	IO_L28N_0	C14	I/O
0	IO_L28P_0	IO_L28P_0	B14	I/O
0	IO_L29N_0	IO_L29N_0	J15	I/O

Table 34: FG900 Package Pinout (Continued)

Bank	XC3S2000 Pin Name	XC3S4000 XC3S5000 Pin Name	FG900 Pin Number	Type
0	IO_L29P_0	IO_L29P_0	H15	I/O
0	IO_L30N_0	IO_L30N_0	G15	I/O
0	IO_L30P_0	IO_L30P_0	F15	I/O
0	IO_L31N_0	IO_L31N_0	D15	I/O
0	IO_L31P_0/ VREF_0	IO_L31P_0/ VREF_0	C15	VREF
0	IO_L32N_0/ GCLK7	IO_L32N_0/ GCLK7	B15	GCLK
0	IO_L32P_0/ GCLK6	IO_L32P_0/ GCLK6	A15	GCLK
0	N.C. (◆)	IO_L35N_0	B7	I/O
0	N.C. (◆)	IO_L35P_0	A7	I/O
0	N.C. (◆)	IO_L36N_0	G7	I/O
0	N.C. (◆)	IO_L36P_0	H8	I/O
0	N.C. (◆)	IO_L37N_0	E9	I/O
0	N.C. (◆)	IO_L37P_0	D9	I/O
0	N.C. (◆)	IO_L38N_0	B9	I/O
0	N.C. (◆)	IO_L38P_0	A9	I/O
0	VCCO_0	VCCO_0	C5	VCCO
0	VCCO_0	VCCO_0	E7	VCCO
0	VCCO_0	VCCO_0	C9	VCCO
0	VCCO_0	VCCO_0	G9	VCCO
0	VCCO_0	VCCO_0	J11	VCCO
0	VCCO_0	VCCO_0	L12	VCCO
0	VCCO_0	VCCO_0	C13	VCCO
0	VCCO_0	VCCO_0	G13	VCCO
0	VCCO_0	VCCO_0	L13	VCCO
0	VCCO_0	VCCO_0	L14	VCCO
1	IO	IO	E25	I/O
1	IO	IO	J21	I/O
1	IO	IO	K20	I/O
1	IO	IO	F18	I/O
1	IO	IO	F16	I/O
1	IO	IO	A16	I/O
1	IO/VREF_1	IO/VREF_1	J17	VREF
1	IO_L01N_1/ VRP_1	IO_L01N_1/ VRP_1	A27	DCI
1	IO_L01P_1/ VRN_1	IO_L01P_1/ VRN_1	B27	DCI
1	IO_L02N_1	IO_L02N_1	D26	I/O
1	IO_L02P_1	IO_L02P_1	C27	I/O
1	IO_L03N_1	IO_L03N_1	A26	I/O
1	IO_L03P_1	IO_L03P_1	B26	I/O
1	IO_L04N_1	IO_L04N_1	B25	I/O
1	IO_L04P_1	IO_L04P_1	C25	I/O
1	IO_L05N_1	IO_L05N_1	F24	I/O

Table 34: FG900 Package Pinout (Continued)

Bank	XC3S2000 Pin Name	XC3S4000 XC3S5000 Pin Name	FG900 Pin Number	Type
1	IO_L05P_1	IO_L05P_1	F25	I/O
1	IO_L06N_1/ VREF_1	IO_L06N_1/ VREF_1	C24	VREF
1	IO_L06P_1	IO_L06P_1	D24	I/O
1	IO_L07N_1	IO_L07N_1	A24	I/O
1	IO_L07P_1	IO_L07P_1	B24	I/O
1	IO_L08N_1	IO_L08N_1	H23	I/O
1	IO_L08P_1	IO_L08P_1	G24	I/O
1	IO_L09N_1	IO_L09N_1	F23	I/O
1	IO_L09P_1	IO_L09P_1	G23	I/O
1	IO_L10N_1/ VREF_1	IO_L10N_1/ VREF_1	C23	VREF
1	IO_L10P_1	IO_L10P_1	D23	I/O
1	IO_L11N_1	IO_L11N_1	A23	I/O
1	IO_L11P_1	IO_L11P_1	B23	I/O
1	IO_L12N_1	IO_L12N_1	H22	I/O
1	IO_L12P_1	IO_L12P_1	J22	I/O
1	IO_L13N_1	IO_L13N_1	F22	I/O
1	IO_L13P_1	IO_L13P_1	E23	I/O
1	IO_L14N_1	IO_L14N_1	D22	I/O
1	IO_L14P_1	IO_L14P_1	E22	I/O
1	IO_L15N_1	IO_L15N_1	A22	I/O
1	IO_L15P_1	IO_L15P_1	B22	I/O
1	IO_L16N_1	IO_L16N_1	F21	I/O
1	IO_L16P_1	IO_L16P_1	G21	I/O
1	IO_L17N_1/ VREF_1	IO_L17N_1/ VREF_1	B21	VREF
1	IO_L17P_1	IO_L17P_1	C21	I/O
1	IO_L18N_1	IO_L18N_1	G20	I/O
1	IO_L18P_1	IO_L18P_1	H20	I/O
1	IO_L19N_1	IO_L19N_1	E20	I/O
1	IO_L19P_1	IO_L19P_1	F20	I/O
1	IO_L20N_1	IO_L20N_1	C20	I/O
1	IO_L20P_1	IO_L20P_1	D20	I/O
1	IO_L21N_1	IO_L21N_1	A20	I/O
1	IO_L21P_1	IO_L21P_1	B20	I/O
1	IO_L22N_1	IO_L22N_1	J19	I/O
1	IO_L22P_1	IO_L22P_1	K19	I/O
1	IO_L23N_1	IO_L23N_1	G19	I/O
1	IO_L23P_1	IO_L23P_1	H19	I/O
1	IO_L24N_1	IO_L24N_1	E19	I/O
1	IO_L24P_1	IO_L24P_1	F19	I/O
1	IO_L25N_1	IO_L25N_1	C19	I/O
1	IO_L25P_1	IO_L25P_1	D19	I/O
1	IO_L26N_1	IO_L26N_1	A19	I/O

Table 34: FG900 Package Pinout (Continued)

Bank	XC3S2000 Pin Name	XC3S4000 XC3S5000 Pin Name	FG900 Pin Number	Type
1	IO_L26P_1	IO_L26P_1	B19	I/O
1	IO_L27N_1	IO_L27N_1	F17	I/O
1	IO_L27P_1	IO_L27P_1	G17	I/O
1	IO_L28N_1	IO_L28N_1	B17	I/O
1	IO_L28P_1	IO_L28P_1	C17	I/O
1	IO_L29N_1	IO_L29N_1	J16	I/O
1	IO_L29P_1	IO_L29P_1	K16	I/O
1	IO_L30N_1	IO_L30N_1	G16	I/O
1	IO_L30P_1	IO_L30P_1	H16	I/O
1	IO_L31N_1/ VREF_1	IO_L31N_1/ VREF_1	D16	VREF
1	IO_L31P_1	IO_L31P_1	E16	I/O
1	IO_L32N_1/ GCLK5	IO_L32N_1/ GCLK5	B16	GCLK
1	IO_L32P_1/ GCLK4	IO_L32P_1/ GCLK4	C16	GCLK
1	N.C. (◆)	IO_L37N_1	H18	I/O
1	N.C. (◆)	IO_L37P_1	J18	I/O
1	N.C. (◆)	IO_L38N_1	D18	I/O
1	N.C. (◆)	IO_L38P_1	E18	I/O
1	N.C. (◆)	IO_L39N_1	A18	I/O
1	N.C. (◆)	IO_L39P_1	B18	I/O
1	N.C. (◆)	IO_L40N_1	K17	I/O
1	N.C. (◆)	IO_L40P_1	K18	I/O
1	VCCO_1	VCCO_1	L17	VCCO
1	VCCO_1	VCCO_1	C18	VCCO
1	VCCO_1	VCCO_1	G18	VCCO
1	VCCO_1	VCCO_1	L18	VCCO
1	VCCO_1	VCCO_1	L19	VCCO
1	VCCO_1	VCCO_1	J20	VCCO
1	VCCO_1	VCCO_1	C22	VCCO
1	VCCO_1	VCCO_1	G22	VCCO
1	VCCO_1	VCCO_1	E24	VCCO
1	VCCO_1	VCCO_1	C26	VCCO
2	IO	IO	J25	I/O
2	IO_L01N_2/ VRP_2	IO_L01N_2/ VRP_2	C29	DCI
2	IO_L01P_2/ VRN_2	IO_L01P_2/ VRN_2	C30	DCI
2	IO_L02N_2	IO_L02N_2	D27	I/O
2	IO_L02P_2	IO_L02P_2	D28	I/O
2	IO_L03N_2/ VREF_2	IO_L03N_2/ VREF_2	D29	VREF
2	IO_L03P_2	IO_L03P_2	D30	I/O
2	IO_L04N_2	IO_L04N_2	E29	I/O
2	IO_L04P_2	IO_L04P_2	E30	I/O

Table 34: FG900 Package Pinout (Continued)

Bank	XC3S2000 Pin Name	XC3S4000 XC3S5000 Pin Name	FG900 Pin Number	Type
2	IO_L05N_2	IO_L05N_2	F28	I/O
2	IO_L05P_2	IO_L05P_2	F29	I/O
2	IO_L06N_2	IO_L06N_2	G27	I/O
2	IO_L06P_2	IO_L06P_2	G28	I/O
2	IO_L07N_2	IO_L07N_2	G29	I/O
2	IO_L07P_2	IO_L07P_2	G30	I/O
2	IO_L08N_2	IO_L08N_2	G25	I/O
2	IO_L08P_2	IO_L08P_2	H24	I/O
2	IO_L09N_2/ VREF_2	IO_L09N_2/ VREF_2	H25	VREF
2	IO_L09P_2	IO_L09P_2	H26	I/O
2	IO_L10N_2	IO_L10N_2	H27	I/O
2	IO_L10P_2	IO_L10P_2	H28	I/O
2	IO_L12N_2	IO_L12N_2	H29	I/O
2	IO_L12P_2	IO_L12P_2	H30	I/O
2	IO_L13N_2	IO_L13N_2	J26	I/O
2	IO_L13P_2/ VREF_2	IO_L13P_2/ VREF_2	J27	VREF
2	IO_L14N_2	IO_L14N_2	J29	I/O
2	IO_L14P_2	IO_L14P_2	J30	I/O
2	IO_L15N_2	IO_L15N_2	J23	I/O
2	IO_L15P_2	IO_L15P_2	K22	I/O
2	IO_L16N_2	IO_L16N_2	K24	I/O
2	IO_L16P_2	IO_L16P_2	K25	I/O
2	IO_L19N_2	IO_L19N_2	L25	I/O
2	IO_L19P_2	IO_L19P_2	L26	I/O
2	IO_L20N_2	IO_L20N_2	L27	I/O
2	IO_L20P_2	IO_L20P_2	L28	I/O
2	IO_L21N_2	IO_L21N_2	L29	I/O
2	IO_L21P_2	IO_L21P_2	L30	I/O
2	IO_L22N_2	IO_L22N_2	M22	I/O
2	IO_L22P_2	IO_L22P_2	M23	I/O
2	IO_L23N_2/ VREF_2	IO_L23N_2/ VREF_2	M24	VREF
2	IO_L23P_2	IO_L23P_2	M25	I/O
2	IO_L24N_2	IO_L24N_2	M27	I/O
2	IO_L24P_2	IO_L24P_2	M28	I/O
2	IO_L26N_2	IO_L26N_2	M21	I/O
2	IO_L26P_2	IO_L26P_2	N21	I/O
2	IO_L27N_2	IO_L27N_2	N22	I/O
2	IO_L27P_2	IO_L27P_2	N23	I/O
2	IO_L28N_2	IO_L28N_2	M26	I/O
2	IO_L28P_2	IO_L28P_2	N25	I/O
2	IO_L29N_2	IO_L29N_2	N26	I/O
2	IO_L29P_2	IO_L29P_2	N27	I/O



**Table 34: FG900 Package Pinout (Continued)**

Bank	XC3S2000 Pin Name	XC3S4000 XC3S5000 Pin Name	FG900 Pin Number	Type
2	IO_L31N_2	IO_L31N_2	N29	I/O
2	IO_L31P_2	IO_L31P_2	N30	I/O
2	IO_L32N_2	IO_L32N_2	P21	I/O
2	IO_L32P_2	IO_L32P_2	P22	I/O
2	IO_L33N_2	IO_L33N_2	P24	I/O
2	IO_L33P_2	IO_L33P_2	P25	I/O
2	IO_L34N_2/ VREF_2	IO_L34N_2/ VREF_2	P28	VREF
2	IO_L34P_2	IO_L34P_2	P29	I/O
2	IO_L35N_2	IO_L35N_2	R21	I/O
2	IO_L35P_2	IO_L35P_2	R22	I/O
2	IO_L37N_2	IO_L37N_2	R23	I/O
2	IO_L37P_2	IO_L37P_2	R24	I/O
2	IO_L38N_2	IO_L38N_2	R25	I/O
2	IO_L38P_2	IO_L38P_2	R26	I/O
2	IO_L39N_2	IO_L39N_2	R27	I/O
2	IO_L39P_2	IO_L39P_2	R28	I/O
2	IO_L40N_2	IO_L40N_2	R29	I/O
2	IO_L40P_2/ VREF_2	IO_L40P_2/ VREF_2	R30	VREF
2	N.C. (◆)	IO_L41N_2	E27	I/O
2	N.C. (◆)	IO_L41P_2	F26	I/O
2	N.C. (◆)	IO_L45N_2	K28	I/O
2	N.C. (◆)	IO_L45P_2	K29	I/O
2	N.C. (◆)	IO_L46N_2	K21	I/O
2	N.C. (◆)	IO_L46P_2	L21	I/O
2	N.C. (◆)	IO_L47N_2	L23	I/O
2	N.C. (◆)	IO_L47P_2	L24	I/O
2	N.C. (◆)	IO_L50N_2	M29	I/O
2	N.C. (◆)	IO_L50P_2	M30	I/O
2	VCCO_2	VCCO_2	M20	VCCO
2	VCCO_2	VCCO_2	N20	VCCO
2	VCCO_2	VCCO_2	P20	VCCO
2	VCCO_2	VCCO_2	L22	VCCO
2	VCCO_2	VCCO_2	J24	VCCO
2	VCCO_2	VCCO_2	N24	VCCO
2	VCCO_2	VCCO_2	G26	VCCO
2	VCCO_2	VCCO_2	E28	VCCO
2	VCCO_2	VCCO_2	J28	VCCO
2	VCCO_2	VCCO_2	N28	VCCO
3	IO	IO	AB25	I/O
3	IO_L01N_3/ VRP_3	IO_L01N_3/ VRP_3	AH30	DCI
3	IO_L01P_3/ VRN_3	IO_L01P_3/ VRN_3	AH29	DCI

**Table 34: FG900 Package Pinout (Continued)**

Bank	XC3S2000 Pin Name	XC3S4000 XC3S5000 Pin Name	FG900 Pin Number	Type
3	IO_L02N_3/ VREF_3	IO_L02N_3/ VREF_3	AG28	VREF
3	IO_L02P_3	IO_L02P_3	AG27	I/O
3	IO_L03N_3	IO_L03N_3	AG30	I/O
3	IO_L03P_3	IO_L03P_3	AG29	I/O
3	IO_L04N_3	IO_L04N_3	AF30	I/O
3	IO_L04P_3	IO_L04P_3	AF29	I/O
3	IO_L05N_3	IO_L05N_3	AE26	I/O
3	IO_L05P_3	IO_L05P_3	AF27	I/O
3	IO_L06N_3	IO_L06N_3	AE29	I/O
3	IO_L06P_3	IO_L06P_3	AE28	I/O
3	IO_L07N_3	IO_L07N_3	AD28	I/O
3	IO_L07P_3	IO_L07P_3	AD27	I/O
3	IO_L08N_3	IO_L08N_3	AD30	I/O
3	IO_L08P_3	IO_L08P_3	AD29	I/O
3	IO_L09N_3	IO_L09N_3	AC24	I/O
3	IO_L09P_3/ VREF_3	IO_L09P_3/ VREF_3	AD25	VREF
3	IO_L10N_3	IO_L10N_3	AC26	I/O
3	IO_L10P_3	IO_L10P_3	AC25	I/O
3	IO_L11N_3	IO_L11N_3	AC28	I/O
3	IO_L11P_3	IO_L11P_3	AC27	I/O
3	IO_L13N_3/ VREF_3	IO_L13N_3/ VREF_3	AC30	VREF
3	IO_L13P_3	IO_L13P_3	AC29	I/O
3	IO_L14N_3	IO_L14N_3	AB27	I/O
3	IO_L14P_3	IO_L14P_3	AB26	I/O
3	IO_L15N_3	IO_L15N_3	AB30	I/O
3	IO_L15P_3	IO_L15P_3	AB29	I/O
3	IO_L16N_3	IO_L16N_3	AA22	I/O
3	IO_L16P_3	IO_L16P_3	AB23	I/O
3	IO_L17N_3	IO_L17N_3	AA25	I/O
3	IO_L17P_3/ VREF_3	IO_L17P_3/ VREF_3	AA24	VREF
3	IO_L19N_3	IO_L19N_3	AA29	I/O
3	IO_L19P_3	IO_L19P_3	AA28	I/O
3	IO_L20N_3	IO_L20N_3	Y21	I/O
3	IO_L20P_3	IO_L20P_3	AA21	I/O
3	IO_L21N_3	IO_L21N_3	Y24	I/O
3	IO_L21P_3	IO_L21P_3	Y23	I/O
3	IO_L22N_3	IO_L22N_3	Y26	I/O
3	IO_L22P_3	IO_L22P_3	Y25	I/O
3	IO_L23N_3	IO_L23N_3	Y28	I/O
3	IO_L23P_3/ VREF_3	IO_L23P_3/ VREF_3	Y27	VREF
3	IO_L24N_3	IO_L24N_3	Y30	I/O

Table 34: FG900 Package Pinout (Continued)

Bank	XC3S2000 Pin Name	XC3S4000 XC3S5000 Pin Name	FG900 Pin Number	Type
3	IO_L24P_3	IO_L24P_3	Y29	I/O
3	IO_L26N_3	IO_L26N_3	W30	I/O
3	IO_L26P_3	IO_L26P_3	W29	I/O
3	IO_L27N_3	IO_L27N_3	V21	I/O
3	IO_L27P_3	IO_L27P_3	W21	I/O
3	IO_L28N_3	IO_L28N_3	V23	I/O
3	IO_L28P_3	IO_L28P_3	V22	I/O
3	IO_L29N_3	IO_L29N_3	V25	I/O
3	IO_L29P_3	IO_L29P_3	W26	I/O
3	IO_L31N_3	IO_L31N_3	V30	I/O
3	IO_L31P_3	IO_L31P_3	V29	I/O
3	IO_L32N_3	IO_L32N_3	U22	I/O
3	IO_L32P_3	IO_L32P_3	U21	I/O
3	IO_L33N_3	IO_L33N_3	U25	I/O
3	IO_L33P_3	IO_L33P_3	U24	I/O
3	IO_L34N_3	IO_L34N_3	U29	I/O
3	IO_L34P_3/ VREF_3	IO_L34P_3/ VREF_3	U28	VREF
3	IO_L35N_3	IO_L35N_3	T22	I/O
3	IO_L35P_3	IO_L35P_3	T21	I/O
3	IO_L37N_3	IO_L37N_3	T24	I/O
3	IO_L37P_3	IO_L37P_3	T23	I/O
3	IO_L38N_3	IO_L38N_3	T26	I/O
3	IO_L38P_3	IO_L38P_3	T25	I/O
3	IO_L39N_3	IO_L39N_3	T28	I/O
3	IO_L39P_3	IO_L39P_3	T27	I/O
3	IO_L40N_3/ VREF_3	IO_L40N_3/ VREF_3	T30	VREF
3	IO_L40P_3	IO_L40P_3	T29	I/O
3	N.C. (◆)	IO_L46N_3	W23	I/O
3	N.C. (◆)	IO_L46P_3	W22	I/O
3	N.C. (◆)	IO_L47N_3	W25	I/O
3	N.C. (◆)	IO_L47P_3	W24	I/O
3	N.C. (◆)	IO_L48N_3	W28	I/O
3	N.C. (◆)	IO_L48P_3	W27	I/O
3	N.C. (◆)	IO_L50N_3	V27	I/O
3	N.C. (◆)	IO_L50P_3	V26	I/O
3	VCCO_3	VCCO_3	U20	VCCO
3	VCCO_3	VCCO_3	V20	VCCO
3	VCCO_3	VCCO_3	W20	VCCO
3	VCCO_3	VCCO_3	Y22	VCCO
3	VCCO_3	VCCO_3	V24	VCCO
3	VCCO_3	VCCO_3	AB24	VCCO
3	VCCO_3	VCCO_3	AD26	VCCO
3	VCCO_3	VCCO_3	V28	VCCO

Table 34: FG900 Package Pinout (Continued)

Bank	XC3S2000 Pin Name	XC3S4000 XC3S5000 Pin Name	FG900 Pin Number	Type
3	VCCO_3	VCCO_3	AB28	VCCO
3	VCCO_3	VCCO_3	AF28	VCCO
4	IO	IO	AA16	I/O
4	IO	IO	AG18	I/O
4	IO	IO	AA18	I/O
4	IO	IO	AE22	I/O
4	IO	IO	AD23	I/O
4	IO	IO	AH27	I/O
4	IO/VREF_4	IO/VREF_4	AF16	VREF
4	IO/VREF_4	IO/VREF_4	AK28	VREF
4	IO_L01N_4/ VRP_4	IO_L01N_4/ VRP_4	AJ27	DCI
4	IO_L01P_4/ VRN_4	IO_L01P_4/ VRN_4	AK27	DCI
4	IO_L02N_4	IO_L02N_4	AJ26	I/O
4	IO_L02P_4	IO_L02P_4	AK26	I/O
4	IO_L03N_4	IO_L03N_4	AG26	I/O
4	IO_L03P_4	IO_L03P_4	AF25	I/O
4	IO_L04N_4	IO_L04N_4	AD24	I/O
4	IO_L04P_4	IO_L04P_4	AC23	I/O
4	IO_L05N_4	IO_L05N_4	AE23	I/O
4	IO_L05P_4	IO_L05P_4	AF23	I/O
4	IO_L06N_4/ VREF_4	IO_L06N_4/ VREF_4	AG23	VREF
4	IO_L06P_4	IO_L06P_4	AH23	I/O
4	IO_L07N_4	IO_L07N_4	AJ23	I/O
4	IO_L07P_4	IO_L07P_4	AK23	I/O
4	IO_L08N_4	IO_L08N_4	AB22	I/O
4	IO_L08P_4	IO_L08P_4	AC22	I/O
4	IO_L09N_4	IO_L09N_4	AF22	I/O
4	IO_L09P_4	IO_L09P_4	AG22	I/O
4	IO_L10N_4	IO_L10N_4	AJ22	I/O
4	IO_L10P_4	IO_L10P_4	AK22	I/O
4	IO_L11N_4	IO_L11N_4	AD21	I/O
4	IO_L11P_4	IO_L11P_4	AE21	I/O
4	IO_L12N_4	IO_L12N_4	AH21	I/O
4	IO_L12P_4	IO_L12P_4	AJ21	I/O
4	IO_L13N_4	IO_L13N_4	AB21	I/O
4	IO_L13P_4	IO_L13P_4	AA20	I/O
4	IO_L14N_4	IO_L14N_4	AC20	I/O
4	IO_L14P_4	IO_L14P_4	AD20	I/O
4	IO_L15N_4	IO_L15N_4	AE20	I/O
4	IO_L15P_4	IO_L15P_4	AF20	I/O
4	IO_L16N_4	IO_L16N_4	AG20	I/O
4	IO_L16P_4	IO_L16P_4	AH20	I/O

Table 34: FG900 Package Pinout (Continued)

Bank	XC3S2000 Pin Name	XC3S4000 XC3S5000 Pin Name	FG900 Pin Number	Type
4	IO_L17N_4	IO_L17N_4	AJ20	I/O
4	IO_L17P_4	IO_L17P_4	AK20	I/O
4	IO_L18N_4	IO_L18N_4	AA19	I/O
4	IO_L18P_4	IO_L18P_4	AB19	I/O
4	IO_L19N_4	IO_L19N_4	AC19	I/O
4	IO_L19P_4	IO_L19P_4	AD19	I/O
4	IO_L20N_4	IO_L20N_4	AE19	I/O
4	IO_L20P_4	IO_L20P_4	AF19	I/O
4	IO_L21N_4	IO_L21N_4	AG19	I/O
4	IO_L21P_4	IO_L21P_4	AH19	I/O
4	IO_L22N_4/ VREF_4	IO_L22N_4/ VREF_4	AJ19	VREF
4	IO_L22P_4	IO_L22P_4	AK19	I/O
4	IO_L23N_4	IO_L23N_4	AB18	I/O
4	IO_L23P_4	IO_L23P_4	AC18	I/O
4	IO_L24N_4	IO_L24N_4	AE18	I/O
4	IO_L24P_4	IO_L24P_4	AF18	I/O
4	IO_L25N_4	IO_L25N_4	AJ18	I/O
4	IO_L25P_4	IO_L25P_4	AK18	I/O
4	IO_L26N_4	IO_L26N_4	AA17	I/O
4	IO_L26P_4/ VREF_4	IO_L26P_4/ VREF_4	AB17	VREF
4	IO_L27N_4/ DIN/D0	IO_L27N_4/ DIN/D0	AD17	DUAL
4	IO_L27P_4/ D1	IO_L27P_4/ D1	AE17	DUAL
4	IO_L28N_4	IO_L28N_4	AH17	I/O
4	IO_L28P_4	IO_L28P_4	AJ17	I/O
4	IO_L29N_4	IO_L29N_4	AB16	I/O
4	IO_L29P_4	IO_L29P_4	AC16	I/O
4	IO_L30N_4/ D2	IO_L30N_4/ D2	AD16	DUAL
4	IO_L30P_4/ D3	IO_L30P_4/ D3	AE16	DUAL
4	IO_L31N_4/ INIT_B	IO_L31N_4/ INIT_B	AG16	DUAL
4	IO_L31P_4/ DOUT/BUSY	IO_L31P_4/ DOUT/BUSY	AH16	DUAL
4	IO_L32N_4/ GCLK1	IO_L32N_4/ GCLK1	AJ16	GCLK
4	IO_L32P_4/ GCLK0	IO_L32P_4/ GCLK0	AK16	GCLK
4	N.C. (◆)	IO_L33N_4	AH25	I/O
4	N.C. (◆)	IO_L33P_4	AJ25	I/O
4	N.C. (◆)	IO_L34N_4	AE25	I/O
4	N.C. (◆)	IO_L34P_4	AE24	I/O
4	N.C. (◆)	IO_L35N_4	AG24	I/O

Table 34: FG900 Package Pinout (Continued)

Bank	XC3S2000 Pin Name	XC3S4000 XC3S5000 Pin Name	FG900 Pin Number	Type
4	N.C. (◆)	IO_L35P_4	AH24	I/O
4	N.C. (◆)	IO_L38N_4	AJ24	I/O
4	N.C. (◆)	IO_L38P_4	AK24	I/O
4	VCCO_4	VCCO_4	Y17	VCCO
4	VCCO_4	VCCO_4	Y18	VCCO
4	VCCO_4	VCCO_4	AD18	VCCO
4	VCCO_4	VCCO_4	AH18	VCCO
4	VCCO_4	VCCO_4	Y19	VCCO
4	VCCO_4	VCCO_4	AB20	VCCO
4	VCCO_4	VCCO_4	AD22	VCCO
4	VCCO_4	VCCO_4	AH22	VCCO
4	VCCO_4	VCCO_4	AF24	VCCO
4	VCCO_4	VCCO_4	AH26	VCCO
5	IO	IO	AE6	I/O
5	IO	IO	AB10	I/O
5	IO	IO	AA11	I/O
5	IO	IO	AA15	I/O
5	IO	IO	AE15	I/O
5	IO/VREF_5	IO/VREF_5	AH4	VREF
5	IO/VREF_5	IO/VREF_5	AK15	VREF
5	IO_L01N_5/ RDWR_B	IO_L01N_5/ RDWR_B	AK4	DUAL
5	IO_L01P_5/ CS_B	IO_L01P_5/ CS_B	AJ4	DUAL
5	IO_L02N_5	IO_L02N_5	AK5	I/O
5	IO_L02P_5	IO_L02P_5	AJ5	I/O
5	IO_L03N_5	IO_L03N_5	AF6	I/O
5	IO_L03P_5	IO_L03P_5	AG5	I/O
5	IO_L04N_5	IO_L04N_5	AJ6	I/O
5	IO_L04P_5	IO_L04P_5	AH6	I/O
5	IO_L05N_5	IO_L05N_5	AE7	I/O
5	IO_L05P_5	IO_L05P_5	AD7	I/O
5	IO_L06N_5	IO_L06N_5	AH7	I/O
5	IO_L06P_5	IO_L06P_5	AG7	I/O
5	IO_L07N_5	IO_L07N_5	AK8	I/O
5	IO_L07P_5	IO_L07P_5	AJ8	I/O
5	IO_L08N_5	IO_L08N_5	AC9	I/O
5	IO_L08P_5	IO_L08P_5	AB9	I/O
5	IO_L09N_5	IO_L09N_5	AG9	I/O
5	IO_L09P_5	IO_L09P_5	AF9	I/O
5	IO_L10N_5/ VRP_5	IO_L10N_5/ VRP_5	AK9	DCI
5	IO_L10P_5/ VRN_5	IO_L10P_5/ VRN_5	AJ9	DCI
5	IO_L11N_5/ VREF_5	IO_L11N_5/ VREF_5	AE10	VREF

Table 34: FG900 Package Pinout (Continued)

Bank	XC3S2000 Pin Name	XC3S4000 XC3S5000 Pin Name	FG900 Pin Number	Type
5	IO_L11P_5	IO_L11P_5	AE9	I/O
5	IO_L12N_5	IO_L12N_5	AJ10	I/O
5	IO_L12P_5	IO_L12P_5	AH10	I/O
5	IO_L13N_5	IO_L13N_5	AD11	I/O
5	IO_L13P_5	IO_L13P_5	AD10	I/O
5	IO_L14N_5	IO_L14N_5	AF11	I/O
5	IO_L14P_5	IO_L14P_5	AE11	I/O
5	IO_L15N_5	IO_L15N_5	AH11	I/O
5	IO_L15P_5	IO_L15P_5	AG11	I/O
5	IO_L16N_5	IO_L16N_5	AK11	I/O
5	IO_L16P_5	IO_L16P_5	AJ11	I/O
5	IO_L17N_5	IO_L17N_5	AB12	I/O
5	IO_L17P_5	IO_L17P_5	AC11	I/O
5	IO_L18N_5	IO_L18N_5	AD12	I/O
5	IO_L18P_5	IO_L18P_5	AC12	I/O
5	IO_L19N_5	IO_L19N_5	AF12	I/O
5	IO_L19P_5/ VREF_5	IO_L19P_5/ VREF_5	AE12	VREF
5	IO_L20N_5	IO_L20N_5	AH12	I/O
5	IO_L20P_5	IO_L20P_5	AG12	I/O
5	IO_L21N_5	IO_L21N_5	AK12	I/O
5	IO_L21P_5	IO_L21P_5	AJ12	I/O
5	IO_L22N_5	IO_L22N_5	AA13	I/O
5	IO_L22P_5	IO_L22P_5	AA12	I/O
5	IO_L23N_5	IO_L23N_5	AC13	I/O
5	IO_L23P_5	IO_L23P_5	AB13	I/O
5	IO_L24N_5	IO_L24N_5	AG13	I/O
5	IO_L24P_5	IO_L24P_5	AF13	I/O
5	IO_L25N_5	IO_L25N_5	AK13	I/O
5	IO_L25P_5	IO_L25P_5	AJ13	I/O
5	IO_L26N_5	IO_L26N_5	AB14	I/O
5	IO_L26P_5	IO_L26P_5	AA14	I/O
5	IO_L27N_5/ VREF_5	IO_L27N_5/ VREF_5	AE14	VREF
5	IO_L27P_5	IO_L27P_5	AE13	I/O
5	IO_L28N_5/ D6	IO_L28N_5/ D6	AJ14	DUAL
5	IO_L28P_5/ D7	IO_L28P_5/ D7	AH14	DUAL
5	IO_L29N_5	IO_L29N_5	AC15	I/O
5	IO_L29P_5/ VREF_5	IO_L29P_5/ VREF_5	AB15	VREF
5	IO_L30N_5	IO_L30N_5	AD15	I/O
5	IO_L30P_5	IO_L30P_5	AD14	I/O
5	IO_L31N_5/ D4	IO_L31N_5/ D4	AG15	DUAL

Table 34: FG900 Package Pinout (Continued)

Bank	XC3S2000 Pin Name	XC3S4000 XC3S5000 Pin Name	FG900 Pin Number	Type
5	IO_L31P_5/ D5	IO_L31P_5/ D5	AF15	DUAL
5	IO_L32N_5/ GCLK3	IO_L32N_5/ GCLK3	AJ15	GCLK
5	IO_L32P_5/ GCLK2	IO_L32P_5/ GCLK2	AH15	GCLK
5	N.C. (◆)	IO_L35N_5	AK7	I/O
5	N.C. (◆)	IO_L35P_5	AJ7	I/O
5	N.C. (◆)	IO_L36N_5	AD8	I/O
5	N.C. (◆)	IO_L36P_5	AC8	I/O
5	N.C. (◆)	IO_L37N_5	AF8	I/O
5	N.C. (◆)	IO_L37P_5	AE8	I/O
5	N.C. (◆)	IO_L38N_5	AH8	I/O
5	N.C. (◆)	IO_L38P_5	AG8	I/O
5	VCCO_5	VCCO_5	AH5	VCCO
5	VCCO_5	VCCO_5	AF7	VCCO
5	VCCO_5	VCCO_5	AD9	VCCO
5	VCCO_5	VCCO_5	AH9	VCCO
5	VCCO_5	VCCO_5	AB11	VCCO
5	VCCO_5	VCCO_5	Y12	VCCO
5	VCCO_5	VCCO_5	Y13	VCCO
5	VCCO_5	VCCO_5	AD13	VCCO
5	VCCO_5	VCCO_5	AH13	VCCO
5	VCCO_5	VCCO_5	Y14	VCCO
6	IO	IO	AB6	I/O
6	IO_L01N_6/ VRP_6	IO_L01N_6/ VRP_6	AH2	DCI
6	IO_L01P_6/ VRN_6	IO_L01P_6/ VRN_6	AH1	DCI
6	IO_L02N_6	IO_L02N_6	AG4	I/O
6	IO_L02P_6	IO_L02P_6	AG3	I/O
6	IO_L03N_6/ VREF_6	IO_L03N_6/ VREF_6	AG2	VREF
6	IO_L03P_6	IO_L03P_6	AG1	I/O
6	IO_L04N_6	IO_L04N_6	AF2	I/O
6	IO_L04P_6	IO_L04P_6	AF1	I/O
6	IO_L05N_6	IO_L05N_6	AF4	I/O
6	IO_L05P_6	IO_L05P_6	AE5	I/O
6	IO_L06N_6	IO_L06N_6	AE3	I/O
6	IO_L06P_6	IO_L06P_6	AE2	I/O
6	IO_L07N_6	IO_L07N_6	AD4	I/O
6	IO_L07P_6	IO_L07P_6	AD3	I/O
6	IO_L08N_6	IO_L08N_6	AD2	I/O
6	IO_L08P_6	IO_L08P_6	AD1	I/O
6	IO_L09N_6/ VREF_6	IO_L09N_6/ VREF_6	AD6	VREF

Table 34: FG900 Package Pinout (Continued)

Bank	XC3S2000 Pin Name	XC3S4000 XC3S5000 Pin Name	FG900 Pin Number	Type
6	IO_L09P_6	IO_L09P_6	AC7	I/O
6	IO_L10N_6	IO_L10N_6	AC6	I/O
6	IO_L10P_6	IO_L10P_6	AC5	I/O
6	IO_L11N_6	IO_L11N_6	AC4	I/O
6	IO_L11P_6	IO_L11P_6	AC3	I/O
6	IO_L13N_6	IO_L13N_6	AC2	I/O
6	IO_L13P_6/ VREF_6	IO_L13P_6/ VREF_6	AC1	VREF
6	IO_L14N_6	IO_L14N_6	AB5	I/O
6	IO_L14P_6	IO_L14P_6	AB4	I/O
6	IO_L15N_6	IO_L15N_6	AB2	I/O
6	IO_L15P_6	IO_L15P_6	AB1	I/O
6	IO_L16N_6	IO_L16N_6	AB8	I/O
6	IO_L16P_6	IO_L16P_6	AA9	I/O
6	IO_L17N_6	IO_L17N_6	AA7	I/O
6	IO_L17P_6/ VREF_6	IO_L17P_6/ VREF_6	AA6	VREF
6	IO_L19N_6	IO_L19N_6	AA3	I/O
6	IO_L19P_6	IO_L19P_6	AA2	I/O
6	IO_L20N_6	IO_L20N_6	AA10	I/O
6	IO_L20P_6	IO_L20P_6	Y10	I/O
6	IO_L21N_6	IO_L21N_6	Y8	I/O
6	IO_L21P_6	IO_L21P_6	Y7	I/O
6	IO_L22N_6	IO_L22N_6	Y6	I/O
6	IO_L22P_6	IO_L22P_6	Y5	I/O
6	IO_L24N_6/ VREF_6	IO_L24N_6/ VREF_6	Y2	VREF
6	IO_L24P_6	IO_L24P_6	Y1	I/O
6	N.C. (◆)	IO_L25N_6	W9	I/O
6	N.C. (◆)	IO_L25P_6	W8	I/O
6	IO_L26N_6	IO_L26N_6	W7	I/O
6	IO_L26P_6	IO_L26P_6	W6	I/O
6	IO_L27N_6	IO_L27N_6	W4	I/O
6	IO_L27P_6	IO_L27P_6	W3	I/O
6	IO_L28N_6	IO_L28N_6	W2	I/O
6	IO_L28P_6	IO_L28P_6	W1	I/O
6	IO_L29N_6	IO_L29N_6	W10	I/O
6	IO_L29P_6	IO_L29P_6	V10	I/O
6	N.C. (◆)	IO_L30N_6	V9	I/O
6	N.C. (◆)	IO_L30P_6	V8	I/O
6	IO_L31N_6	IO_L31N_6	W5	I/O
6	IO_L31P_6	IO_L31P_6	V6	I/O
6	IO_L32N_6	IO_L32N_6	V5	I/O
6	IO_L32P_6	IO_L32P_6	V4	I/O
6	IO_L33N_6	IO_L33N_6	V2	I/O

Table 34: FG900 Package Pinout (Continued)

Bank	XC3S2000 Pin Name	XC3S4000 XC3S5000 Pin Name	FG900 Pin Number	Type
6	IO_L33P_6	IO_L33P_6	V1	I/O
6	IO_L34N_6/ VREF_6	IO_L34N_6/ VREF_6	U10	VREF
6	IO_L34P_6	IO_L34P_6	U9	I/O
6	IO_L35N_6	IO_L35N_6	U7	I/O
6	IO_L35P_6	IO_L35P_6	U6	I/O
6	N.C. (◆)	IO_L36N_6	U3	I/O
6	N.C. (◆)	IO_L36P_6	U2	I/O
6	IO_L37N_6	IO_L37N_6	T10	I/O
6	IO_L37P_6	IO_L37P_6	T9	I/O
6	IO_L38N_6	IO_L38N_6	T6	I/O
6	IO_L38P_6	IO_L38P_6	T5	I/O
6	IO_L39N_6	IO_L39N_6	T4	I/O
6	IO_L39P_6	IO_L39P_6	T3	I/O
6	IO_L40N_6	IO_L40N_6	T2	I/O
6	IO_L40P_6/ VREF_6	IO_L40P_6/ VREF_6	T1	VREF
6	N.C. (◆)	IO_L45N_6	Y4	I/O
6	N.C. (◆)	IO_L45P_6	Y3	I/O
6	N.C. (◆)	IO_L52N_6	T8	I/O
6	N.C. (◆)	IO_L52P_6	T7	I/O
6	VCCO_6	VCCO_6	V3	VCCO
6	VCCO_6	VCCO_6	AB3	VCCO
6	VCCO_6	VCCO_6	AF3	VCCO
6	VCCO_6	VCCO_6	AD5	VCCO
6	VCCO_6	VCCO_6	V7	VCCO
6	VCCO_6	VCCO_6	AB7	VCCO
6	VCCO_6	VCCO_6	Y9	VCCO
6	VCCO_6	VCCO_6	U11	VCCO
6	VCCO_6	VCCO_6	V11	VCCO
6	VCCO_6	VCCO_6	W11	VCCO
7	IO	IO	J6	I/O
7	IO_L01N_7/ VRP_7	IO_L01N_7/ VRP_7	C1	DCI
7	IO_L01P_7/ VRN_7	IO_L01P_7/ VRN_7	C2	DCI
7	IO_L02N_7	IO_L02N_7	D3	I/O
7	IO_L02P_7	IO_L02P_7	D4	I/O
7	IO_L03N_7/ VREF_7	IO_L03N_7/ VREF_7	D1	VREF
7	IO_L03P_7	IO_L03P_7	D2	I/O
7	IO_L04N_7	IO_L04N_7	E1	I/O
7	IO_L04P_7	IO_L04P_7	E2	I/O
7	IO_L05N_7	IO_L05N_7	F5	I/O
7	IO_L05P_7	IO_L05P_7	E4	I/O
7	IO_L06N_7	IO_L06N_7	F2	I/O

Table 34: FG900 Package Pinout (Continued)

Bank	XC3S2000 Pin Name	XC3S4000 XC3S5000 Pin Name	FG900 Pin Number	Type
7	IO_L06P_7	IO_L06P_7	F3	I/O
7	IO_L07N_7	IO_L07N_7	G3	I/O
7	IO_L07P_7	IO_L07P_7	G4	I/O
7	IO_L08N_7	IO_L08N_7	G1	I/O
7	IO_L08P_7	IO_L08P_7	G2	I/O
7	IO_L09N_7	IO_L09N_7	H7	I/O
7	IO_L09P_7	IO_L09P_7	G6	I/O
7	IO_L10N_7	IO_L10N_7	H5	I/O
7	IO_L10P_7/ VREF_7	IO_L10P_7/ VREF_7	H6	VREF
7	IO_L11N_7	IO_L11N_7	H3	I/O
7	IO_L11P_7	IO_L11P_7	H4	I/O
7	IO_L13N_7	IO_L13N_7	H1	I/O
7	IO_L13P_7	IO_L13P_7	H2	I/O
7	IO_L14N_7	IO_L14N_7	J4	I/O
7	IO_L14P_7	IO_L14P_7	J5	I/O
7	IO_L15N_7	IO_L15N_7	J1	I/O
7	IO_L15P_7	IO_L15P_7	J2	I/O
7	IO_L16N_7	IO_L16N_7	K9	I/O
7	IO_L16P_7/ VREF_7	IO_L16P_7/ VREF_7	J8	VREF
7	IO_L17N_7	IO_L17N_7	K6	I/O
7	IO_L17P_7	IO_L17P_7	K7	I/O
7	IO_L19N_7/ VREF_7	IO_L19N_7/ VREF_7	K2	VREF
7	IO_L19P_7	IO_L19P_7	K3	I/O
7	IO_L20N_7	IO_L20N_7	L10	I/O
7	IO_L20P_7	IO_L20P_7	K10	I/O
7	IO_L21N_7	IO_L21N_7	L7	I/O
7	IO_L21P_7	IO_L21P_7	L8	I/O
7	IO_L22N_7	IO_L22N_7	L5	I/O
7	IO_L22P_7	IO_L22P_7	L6	I/O
7	IO_L23N_7	IO_L23N_7	L3	I/O
7	IO_L23P_7	IO_L23P_7	L4	I/O
7	IO_L24N_7	IO_L24N_7	L1	I/O
7	IO_L24P_7	IO_L24P_7	L2	I/O
7	N.C. (◆)	IO_L25N_7	M6	I/O
7	N.C. (◆)	IO_L25P_7	M7	I/O
7	IO_L26N_7	IO_L26N_7	M3	I/O
7	IO_L26P_7	IO_L26P_7	M4	I/O
7	IO_L27N_7	IO_L27N_7	M1	I/O
7	IO_L27P_7/ VREF_7	IO_L27P_7/ VREF_7	M2	VREF
7	IO_L28N_7	IO_L28N_7	N10	I/O
7	IO_L28P_7	IO_L28P_7	M10	I/O
7	IO_L29N_7	IO_L29N_7	N8	I/O

Table 34: FG900 Package Pinout (Continued)

Bank	XC3S2000 Pin Name	XC3S4000 XC3S5000 Pin Name	FG900 Pin Number	Type
7	IO_L29P_7	IO_L29P_7	N9	I/O
7	IO_L31N_7	IO_L31N_7	N1	I/O
7	IO_L31P_7	IO_L31P_7	N2	I/O
7	IO_L32N_7	IO_L32N_7	P9	I/O
7	IO_L32P_7	IO_L32P_7	P10	I/O
7	IO_L33N_7	IO_L33N_7	P6	I/O
7	IO_L33P_7	IO_L33P_7	P7	I/O
7	IO_L34N_7	IO_L34N_7	P2	I/O
7	IO_L34P_7	IO_L34P_7	P3	I/O
7	IO_L35N_7	IO_L35N_7	R9	I/O
7	IO_L35P_7	IO_L35P_7	R10	I/O
7	IO_L37N_7	IO_L37N_7	R7	I/O
7	IO_L37P_7/ VREF_7	IO_L37P_7/ VREF_7	R8	VREF
7	IO_L38N_7	IO_L38N_7	R5	I/O
7	IO_L38P_7	IO_L38P_7	R6	I/O
7	IO_L39N_7	IO_L39N_7	R3	I/O
7	IO_L39P_7	IO_L39P_7	R4	I/O
7	IO_L40N_7/ VREF_7	IO_L40N_7/ VREF_7	R1	VREF
7	IO_L40P_7	IO_L40P_7	R2	I/O
7	N.C. (◆)	IO_L46N_7	M8	I/O
7	N.C. (◆)	IO_L46P_7	M9	I/O
7	N.C. (◆)	IO_L49N_7	N6	I/O
7	N.C. (◆)	IO_L49P_7	M5	I/O
7	N.C. (◆)	IO_L50N_7	N4	I/O
7	N.C. (◆)	IO_L50P_7	N5	I/O
7	VCCO_7	VCCO_7	E3	VCCO
7	VCCO_7	VCCO_7	J3	VCCO
7	VCCO_7	VCCO_7	N3	VCCO
7	VCCO_7	VCCO_7	G5	VCCO
7	VCCO_7	VCCO_7	J7	VCCO
7	VCCO_7	VCCO_7	N7	VCCO
7	VCCO_7	VCCO_7	L9	VCCO
7	VCCO_7	VCCO_7	M11	VCCO
7	VCCO_7	VCCO_7	N11	VCCO
7	VCCO_7	VCCO_7	P11	VCCO
N/A	GND	GND	A1	GND
N/A	GND	GND	B1	GND
N/A	GND	GND	F1	GND
N/A	GND	GND	K1	GND
N/A	GND	GND	P1	GND
N/A	GND	GND	U1	GND
N/A	GND	GND	AA1	GND
N/A	GND	GND	AE1	GND

Table 34: FG900 Package Pinout (Continued)

Bank	XC3S2000 Pin Name	XC3S4000 XC3S5000 Pin Name	FG900 Pin Number	Type
N/A	GND	GND	AJ1	GND
N/A	GND	GND	AK1	GND
N/A	GND	GND	A2	GND
N/A	GND	GND	B2	GND
N/A	GND	GND	AJ2	GND
N/A	GND	GND	E5	GND
N/A	GND	GND	K5	GND
N/A	GND	GND	P5	GND
N/A	GND	GND	U5	GND
N/A	GND	GND	AA5	GND
N/A	GND	GND	AF5	GND
N/A	GND	GND	A6	GND
N/A	GND	GND	AK6	GND
N/A	GND	GND	K8	GND
N/A	GND	GND	P8	GND
N/A	GND	GND	U8	GND
N/A	GND	GND	AA8	GND
N/A	GND	GND	A10	GND
N/A	GND	GND	E10	GND
N/A	GND	GND	H10	GND
N/A	GND	GND	AC10	GND
N/A	GND	GND	AF10	GND
N/A	GND	GND	AK10	GND
N/A	GND	GND	R12	GND
N/A	GND	GND	T12	GND
N/A	GND	GND	N13	GND
N/A	GND	GND	P13	GND
N/A	GND	GND	R13	GND
N/A	GND	GND	T13	GND
N/A	GND	GND	U13	GND
N/A	GND	GND	V13	GND
N/A	GND	GND	A14	GND
N/A	GND	GND	E14	GND
N/A	GND	GND	H14	GND
N/A	GND	GND	N14	GND
N/A	GND	GND	P14	GND
N/A	GND	GND	R14	GND
N/A	GND	GND	T14	GND
N/A	GND	GND	U14	GND
N/A	GND	GND	V14	GND
N/A	GND	GND	AC14	GND
N/A	GND	GND	AF14	GND
N/A	GND	GND	AK14	GND
N/A	GND	GND	M15	GND
N/A	GND	GND	N15	GND

Table 34: FG900 Package Pinout (Continued)

Bank	XC3S2000 Pin Name	XC3S4000 XC3S5000 Pin Name	FG900 Pin Number	Type
N/A	GND	GND	P15	GND
N/A	GND	GND	R15	GND
N/A	GND	GND	T15	GND
N/A	GND	GND	U15	GND
N/A	GND	GND	V15	GND
N/A	GND	GND	W15	GND
N/A	GND	GND	M16	GND
N/A	GND	GND	N16	GND
N/A	GND	GND	P16	GND
N/A	GND	GND	R16	GND
N/A	GND	GND	T16	GND
N/A	GND	GND	U16	GND
N/A	GND	GND	V16	GND
N/A	GND	GND	W16	GND
N/A	GND	GND	A17	GND
N/A	GND	GND	E17	GND
N/A	GND	GND	H17	GND
N/A	GND	GND	N17	GND
N/A	GND	GND	P17	GND
N/A	GND	GND	R17	GND
N/A	GND	GND	T17	GND
N/A	GND	GND	U17	GND
N/A	GND	GND	V17	GND
N/A	GND	GND	AC17	GND
N/A	GND	GND	AF17	GND
N/A	GND	GND	AK17	GND
N/A	GND	GND	N18	GND
N/A	GND	GND	P18	GND
N/A	GND	GND	R18	GND
N/A	GND	GND	T18	GND
N/A	GND	GND	U18	GND
N/A	GND	GND	V18	GND
N/A	GND	GND	R19	GND
N/A	GND	GND	T19	GND
N/A	GND	GND	A21	GND
N/A	GND	GND	E21	GND
N/A	GND	GND	H21	GND
N/A	GND	GND	AC21	GND
N/A	GND	GND	AF21	GND
N/A	GND	GND	AK21	GND
N/A	GND	GND	K23	GND
N/A	GND	GND	P23	GND
N/A	GND	GND	U23	GND
N/A	GND	GND	AA23	GND
N/A	GND	GND	A25	GND

Table 34: FG900 Package Pinout (Continued)

Bank	XC3S2000 Pin Name	XC3S4000 XC3S5000 Pin Name	FG900 Pin Number	Type
N/A	GND	GND	AK25	GND
N/A	GND	GND	E26	GND
N/A	GND	GND	K26	GND
N/A	GND	GND	P26	GND
N/A	GND	GND	U26	GND
N/A	GND	GND	AA26	GND
N/A	GND	GND	AF26	GND
N/A	GND	GND	A29	GND
N/A	GND	GND	B29	GND
N/A	GND	GND	AJ29	GND
N/A	GND	GND	AK29	GND
N/A	GND	GND	A30	GND
N/A	GND	GND	B30	GND
N/A	GND	GND	F30	GND
N/A	GND	GND	K30	GND
N/A	GND	GND	P30	GND
N/A	GND	GND	U30	GND
N/A	GND	GND	AA30	GND
N/A	GND	GND	AE30	GND
N/A	GND	GND	AJ30	GND
N/A	GND	GND	AK30	GND
N/A	GND	GND	AK2	GND
N/A	VCCAUX	VCCAUX	F4	VCCAUX
N/A	VCCAUX	VCCAUX	K4	VCCAUX
N/A	VCCAUX	VCCAUX	P4	VCCAUX
N/A	VCCAUX	VCCAUX	U4	VCCAUX
N/A	VCCAUX	VCCAUX	AA4	VCCAUX
N/A	VCCAUX	VCCAUX	AE4	VCCAUX
N/A	VCCAUX	VCCAUX	D6	VCCAUX
N/A	VCCAUX	VCCAUX	AG6	VCCAUX
N/A	VCCAUX	VCCAUX	D10	VCCAUX
N/A	VCCAUX	VCCAUX	AG10	VCCAUX
N/A	VCCAUX	VCCAUX	D14	VCCAUX
N/A	VCCAUX	VCCAUX	AG14	VCCAUX
N/A	VCCAUX	VCCAUX	D17	VCCAUX
N/A	VCCAUX	VCCAUX	AG17	VCCAUX
N/A	VCCAUX	VCCAUX	D21	VCCAUX
N/A	VCCAUX	VCCAUX	AG21	VCCAUX
N/A	VCCAUX	VCCAUX	D25	VCCAUX
N/A	VCCAUX	VCCAUX	AG25	VCCAUX
N/A	VCCAUX	VCCAUX	F27	VCCAUX
N/A	VCCAUX	VCCAUX	K27	VCCAUX
N/A	VCCAUX	VCCAUX	P27	VCCAUX
N/A	VCCAUX	VCCAUX	U27	VCCAUX
N/A	VCCAUX	VCCAUX	AA27	VCCAUX

Table 34: FG900 Package Pinout (Continued)

Bank	XC3S2000 Pin Name	XC3S4000 XC3S5000 Pin Name	FG900 Pin Number	Type
N/A	VCCAUX	VCCAUX	AE27	VCCAUX
N/A	VCCINT	VCCINT	L11	VCCINT
N/A	VCCINT	VCCINT	R11	VCCINT
N/A	VCCINT	VCCINT	T11	VCCINT
N/A	VCCINT	VCCINT	Y11	VCCINT
N/A	VCCINT	VCCINT	M12	VCCINT
N/A	VCCINT	VCCINT	N12	VCCINT
N/A	VCCINT	VCCINT	P12	VCCINT
N/A	VCCINT	VCCINT	U12	VCCINT
N/A	VCCINT	VCCINT	V12	VCCINT
N/A	VCCINT	VCCINT	W12	VCCINT
N/A	VCCINT	VCCINT	M13	VCCINT
N/A	VCCINT	VCCINT	W13	VCCINT
N/A	VCCINT	VCCINT	M14	VCCINT
N/A	VCCINT	VCCINT	W14	VCCINT
N/A	VCCINT	VCCINT	L15	VCCINT
N/A	VCCINT	VCCINT	Y15	VCCINT
N/A	VCCINT	VCCINT	L16	VCCINT
N/A	VCCINT	VCCINT	Y16	VCCINT
N/A	VCCINT	VCCINT	M17	VCCINT
N/A	VCCINT	VCCINT	W17	VCCINT
N/A	VCCINT	VCCINT	M18	VCCINT
N/A	VCCINT	VCCINT	W18	VCCINT
N/A	VCCINT	VCCINT	M19	VCCINT
N/A	VCCINT	VCCINT	N19	VCCINT
N/A	VCCINT	VCCINT	P19	VCCINT
N/A	VCCINT	VCCINT	U19	VCCINT
N/A	VCCINT	VCCINT	V19	VCCINT
N/A	VCCINT	VCCINT	W19	VCCINT
N/A	VCCINT	VCCINT	L20	VCCINT
N/A	VCCINT	VCCINT	R20	VCCINT
N/A	VCCINT	VCCINT	T20	VCCINT
N/A	VCCINT	VCCINT	Y20	VCCINT
VCCAUX	CCLK	CCLK	AH28	CONFIG
VCCAUX	DONE	DONE	AJ28	CONFIG
VCCAUX	HSWAP_EN	HSWAP_EN	A3	CONFIG
VCCAUX	M0	M0	AJ3	CONFIG
VCCAUX	M1	M1	AH3	CONFIG
VCCAUX	M2	M2	AK3	CONFIG
VCCAUX	PROG_B	PROG_B	B3	CONFIG
VCCAUX	TCK	TCK	B28	JTAG
VCCAUX	TDI	TDI	C3	JTAG
VCCAUX	TDO	TDO	C28	JTAG
VCCAUX	TMS	TMS	A28	JTAG



## User I/Os by Bank

Table 35 indicates how the available user-I/O pins are distributed between the eight I/O banks for the XC3S2000 in the FG900 package. Similarly, Table 36 shows how the

available user-I/O pins are distributed between the eight I/O banks for the XC3S4000 and XC3S5000 in the FG900 package.

Table 35: User I/Os Per Bank for XC3S2000 in FG900 Package

Edge	I/O Bank	Maximum I/O	All Possible I/O Pins by Type				
			I/O	DUAL	DCI	VREF	GCLK
Top	0	71	62	0	2	5	2
	1	71	62	0	2	5	2
Right	2	69	61	0	2	6	0
	3	71	62	0	2	7	0
Bottom	4	72	57	6	2	5	2
	5	71	55	6	2	6	2
Left	6	69	60	0	2	7	0
	7	71	62	0	2	7	0

Table 36: User I/Os Per Bank for XC3S4000 and XC3S5000 in FG900 Package

Edge	I/O Bank	Maximum I/O	All Possible I/O Pins by Type				
			I/O	DUAL	DCI	VREF	GCLK
Top	0	79	70	0	2	5	2
	1	79	70	0	2	5	2
Right	2	79	71	0	2	6	0
	3	79	70	0	2	7	0
Bottom	4	80	65	6	2	5	2
	5	79	63	6	2	6	2
Left	6	79	70	0	2	7	0
	7	79	70	0	2	7	0

## FG900 Footprint

### Left Half of Package (top view)

#### XC3S2000

(565 max. user I/O)

481 I/O: Unrestricted, general-purpose user I/O

48 VREF: User I/O or input voltage reference for bank

68 N.C.: Unconnected pins for XC3S2000 (◆)

#### XC3S4000, XC3S5000

(633 max user I/O)

549 I/O: Unrestricted, general-purpose user I/O

48 VREF: User I/O or input voltage reference for bank

0 N.C.: No unconnected pins in this package

#### All devices

12 DUAL: Configuration pin, then possible user I/O

8 GCLK: User I/O or global clock buffer input

16 DCI: User I/O or reference resistor input for bank

7 CONFIG: Dedicated configuration pins

4 JTAG: Dedicated JTAG port pins

32 VCCINT: Internal core voltage supply (+1.2V)

80 VCCO: Output voltage supply for bank

24 VCCAUX: Auxiliary voltage supply (+2.5V)

120 GND: Ground

	Bank 0															
	1	2	3	4	5	6	7	8	9	10	11	12	13	14	15	
A	GND	GND	HSWAP_EN	I/O L01P_0 VRN_0	I/O L02P_0	GND	I/O L35P_0	I/O L09P_0	I/O L38P_0	GND	I/O L17P_0	I/O L22P_0	I/O L25P_0	GND	I/O L32P_0 GCLK6	
B	GND	GND	PROG_B	I/O L01N_0 VRP_0	I/O L04P_0	I/O L03N_0	I/O L08P_0	I/O L09N_0	I/O L38N_0	I/O L12P_0	I/O L17N_0	I/O L22N_0	I/O L25N_0	I/O L28P_0	I/O L32N_0 GCLK7	
C	I/O L01N_7 VRP_7	I/O L01P_7 VRN_7	TDI	I/O VREF_0	VCCO_0	I/O L04N_0	I/O L06P_0	I/O L08P_0	VCCO_0	I/O L12N_0	I/O L16P_0	I/O L21P_0	VCCO_0	I/O L28N_0	I/O L31P_0 VREF_0	
D	I/O L03N_7 VREF_7	I/O L03P_7	I/O L02N_7	I/O L02P_7	I/O L03N_0	VCCAUX	I/O L06N_0	I/O L08N_0	I/O L37P_0	VCCAUX	I/O L16N_0	I/O L21N_0	I/O	VCCAUX	I/O L31N_0	
E	I/O L04N_7	I/O L04P_7	VCCO_7	I/O L05P_7	GND	I/O L03P_0	VCCO_0	I/O L07P_0	I/O L37N_0	GND	I/O L15P_0	I/O L20P_0	I/O L24P_0	GND	I/O	
F	GND	I/O L06N_7	I/O L06P_7	VCCAUX	I/O L05N_7	I/O L05N_0	I/O L05P_0 VREF_0	I/O L07N_0	I/O VREF_0	I/O L11P_0	I/O L15N_0	I/O L20N_0	I/O L24N_0	I/O L27P_0	I/O L30P_0	
G	I/O L08N_7	I/O L08P_7	I/O L07N_7	I/O L07P_7	VCCO_7	I/O L09P_7	I/O L36N_0	I/O	VCCO_0	I/O L11N_0	I/O L14P_0	I/O L19P_0	VCCO_0	I/O L27N_0	I/O L30N_0	
H	I/O L13N_7	I/O L13P_7	I/O L11N_7	I/O L11P_7	I/O L10N_7	I/O L10P_7 VREF_7	I/O L09N_7	I/O L36P_0	I/O L10P_0	GND	I/O L14N_0	I/O L19N_0	I/O L23P_0	GND	I/O L29P_0	
J	I/O L15N_7	I/O L15P_7	VCCO_7	I/O L14N_7	I/O L14P_7	I/O	VCCO_7	I/O L16P_7 VREF_7	I/O L10N_0	I/O L13N_0	VCCO_0	I/O L18P_0	I/O L23N_0	I/O L26P_0 VREF_0	I/O L29N_0	
K	GND	I/O L19N_7 VREF_7	I/O L19P_7	VCCAUX	GND	I/O L17N_7	I/O L17P_7	GND	I/O L16N_7	I/O L20P_7	I/O L13P_0	I/O L18N_0	I/O	I/O L26N_0	I/O	
L	I/O L24N_7	I/O L24P_7	I/O L23N_7	I/O L23P_7	I/O L22N_7	I/O L22P_7	I/O L21N_7	I/O L21P_7	VCCO_7	I/O L20N_7	VCCINT	VCCO_0	VCCO_0	VCCO_0	VCCINT	
M	I/O L27N_7	I/O L27P_7 VREF_7	I/O L26N_7	I/O L26P_7	I/O L49P_7	I/O L25N_7	I/O L25P_7	I/O L46N_7	I/O L46P_7	I/O L28P_7	VCCO_7	VCCINT	VCCINT	VCCINT	GND	
N	I/O L31N_7	I/O L31P_7	VCCO_7	I/O L50N_7	I/O L50P_7	I/O L49N_7	VCCO_7	I/O L29N_7	I/O L29P_7	I/O L28N_7	VCCO_7	VCCINT	GND	GND	GND	
P	GND	I/O L34N_7	I/O L34P_7	VCCAUX	GND	I/O L33N_7	I/O L33P_7	GND	I/O L32N_7	I/O L32P_7	VCCO_7	VCCINT	GND	GND	GND	
R	I/O L40N_7 VREF_7	I/O L40P_7	I/O L39N_7	I/O L39P_7	I/O L38N_7	I/O L38P_7	I/O L37N_7	I/O L37P_7 VREF_7	I/O L35N_7	I/O L35P_7	VCCINT	GND	GND	GND	GND	
T	I/O L40P_6 VREF_6	I/O L40N_6	I/O L39P_6	I/O L39N_6	I/O L38P_6	I/O L38N_6	I/O L52P_6	I/O L52N_6	I/O L37P_6	I/O L37N_6	VCCINT	GND	GND	GND	GND	
U	GND	I/O L36P_6	I/O L36N_6	VCCAUX	GND	I/O L35P_6	I/O L35N_6	GND	I/O L34P_6	I/O L34N_6 VREF_6	VCCO_6	VCCINT	GND	GND	GND	
V	I/O L33P_6	I/O L33N_6	VCCO_6	I/O L32P_6	I/O L32N_6	I/O L31P_6	VCCO_6	I/O L30P_6	I/O L30N_6	I/O L29P_6	VCCO_6	VCCINT	GND	GND	GND	
W	I/O L28P_6	I/O L28N_6	I/O L27P_6	I/O L27N_6	I/O L31N_6	I/O L26P_6	I/O L26N_6	I/O L25P_6	I/O L25N_6	I/O L29N_6	VCCO_6	VCCINT	VCCINT	VCCINT	GND	
Y	I/O L24P_6	I/O L24N_6 VREF_6	I/O L45P_6	I/O L45N_6	I/O L22P_6	I/O L22N_6	I/O L21P_6	I/O L21N_6	VCCO_6	I/O L20P_6	VCCINT	VCCO_5	VCCO_5	VCCO_5	VCCINT	
A	GND	I/O L19P_6	I/O L19N_6	VCCAUX	GND	I/O L17P_6 VREF_6	I/O L17N_6	GND	I/O L16P_6	I/O L20N_6	I/O	I/O L22P_5	I/O L22N_5	I/O L26P_5	I/O	
B	I/O L15P_6	I/O L15N_6	VCCO_6	I/O L14P_6	I/O L14N_6	I/O	VCCO_6	I/O L16N_6	I/O L08P_5	I/O	VCCO_5	I/O L17N_5	I/O L23P_5	I/O L28N_5	I/O L29P_5 VREF_5	
C	I/O L13P_6 VREF_6	I/O L13N_6	I/O L11P_6	I/O L11N_6	I/O L10P_6	I/O L10N_6	I/O L09P_6	I/O L36P_5	I/O L08N_5	GND	I/O L17P_5	I/O L18P_5	I/O L23N_5	GND	I/O L29N_5	
A	I/O L08P_6	I/O L08N_6	I/O L07P_6	I/O L07N_6	VCCO_6	I/O L09N_6 VREF_6	I/O L05P_5	I/O L36N_5	I/O L37N_5	VCCO_5	I/O L13P_5	I/O L13N_5	I/O L18N_5	VCCO_5	I/O L30P_5	I/O L30N_5
E	GND	I/O L06P_6	I/O L06N_6	VCCAUX	I/O L05P_6	I/O	I/O L05N_5	I/O L37P_5	I/O L11P_5	I/O L11N_5 VREF_5	I/O L14P_5	I/O L19P_5 VREF_5	I/O L27P_5	I/O L27N_5 VREF_5	I/O	
A	I/O L04P_6	I/O L04N_6	VCCO_6	I/O L05N_6	GND	I/O L03N_5	VCCO_5	I/O L37N_5	I/O L09P_5	GND	I/O L14N_5	I/O L19N_5	I/O L24P_5	GND	I/O L31P_5 D5	
A	I/O L03P_6	I/O L03N_6 VREF_6	I/O L02P_6	I/O L02N_6	I/O L03P_5	VCCAUX	I/O L06P_5	I/O L38P_5	I/O L09N_5	VCCAUX	I/O L15P_5	I/O L20P_5	I/O L24N_5	VCCAUX	I/O L31N_5 D4	
A	I/O L01P_6 VRN_6	I/O L01N_6 VRP_6	M1	I/O VREF_5	VCCO_5	I/O L04P_5	I/O L06N_5	I/O L38N_5	VCCO_5	I/O L12P_5	I/O L15N_5	I/O L20N_5	VCCO_5	I/O L28P_5 D7	I/O L32P_5 GCLK2	
A	GND	GND	M0	I/O L01P_5 CS_B	I/O L02P_5	I/O L04N_5	I/O L35P_5	I/O L07P_5	I/O L10P_5 VRN_5	I/O L12N_5	I/O L16P_5	I/O L21P_5	I/O L25P_5	I/O L28N_5 D6	I/O L32N_5 GCLK3	
A	GND	GND	M2	I/O L01N_5 RDWR_B	I/O L02N_5	GND	I/O L35N_5	I/O L07N_5	I/O L10N_5 VRP_5	GND	I/O L16N_5	I/O L21N_5	I/O L25N_5	GND	I/O VREF_5	

Figure 15: FG900 Package Footprint (top view)

DS099-4\_13a\_121103

		Bank 1																Bank 2																Bank 3																Bank 4														
		16	17	18	19	20	21	22	23	24	25	26	27	28	29	30														31	32	33														34	35	36														37	38	39
I/O	GND	I/O L39N_1 ♦	I/O L26N_1	I/O L21N_1	GND	I/O L15N_1	I/O L11N_1	I/O L07N_1	GND	I/O L03N_1	I/O L01N_1 VRP_1	TMS	GND	GND	A																																																	
I/O L32N_1 GCLK5	I/O L28N_1	I/O L39P_1 ♦	I/O L26P_1	I/O L21P_1	I/O L17N_1 VREF_1	I/O L15P_1	I/O L11P_1	I/O L07P_1	I/O L04N_1	I/O L03P_1	I/O L01P_1 VRN_1	TCK	GND	GND	B																																																	
I/O L32P_1 GCLK4	I/O L28P_1	VCCO_1	I/O L25N_1	I/O L20N_1	I/O L17P_1	VCCO_1	I/O L10N_1 VREF_1	I/O L06N_1 VREF_1	I/O L04P_1	VCCO_1	I/O L02P_1	TDO	I/O L01N_2 VRP_2	I/O L01P_2 VRN_2	C																																																	
I/O L31N_1 VREF_1	VCCAUX	I/O L38N_1 ♦	I/O L25P_1	I/O L20P_1	VCCAUX	I/O L14N_1	I/O L10P_1	I/O L06P_1	VCCAUX	I/O L02N_1	I/O L02N_2	I/O L02P_2	I/O L03N_2 VREF_2	I/O L03P_2	D																																																	
I/O L31P_1	GND	I/O L38P_1 ♦	I/O L24N_1	I/O L19N_1	GND	I/O L14P_1	I/O L13P_1	VCCO_1	I/O	GND	I/O L41N_2 ♦	VCCO_2	I/O L04N_2	I/O L04P_2	E																																																	
I/O	I/O L27N_1	I/O	I/O L24P_1	I/O L19P_1	I/O L16N_1	I/O L13N_1	I/O L09N_1	I/O L05N_1	I/O L05P_1	I/O L41P_2 ♦	VCCAUX	I/O L05N_2	I/O L05P_2	GND	F																																																	
I/O L30N_1	I/O L27P_1	VCCO_1	I/O L23N_1	I/O L18N_1	I/O L16P_1	VCCO_1	I/O L09P_1	I/O L08P_1	I/O L08N_2	VCCO_2	I/O L06N_2	I/O L06P_2	I/O L07N_2	I/O L07P_2	G																																																	
I/O L30P_1	GND	I/O L37N_1 ♦	I/O L23P_1	I/O L18P_1	GND	I/O L12N_1	I/O L08N_1	I/O L08P_2	I/O L09N_2 VREF_2	I/O L09P_2	I/O L10N_2	I/O L10P_2	I/O L12N_2	I/O L12P_2	H																																																	
I/O L29N_1	I/O VREF_1	I/O L37P_1 ♦	I/O L22N_1	VCCO_1	I/O	I/O L12P_1	I/O L15N_2	VCCO_2	I/O	I/O L13N_2	I/O L13P_2 VREF_2	VCCO_2	I/O L14N_2	I/O L14P_2	J																																																	
I/O L29P_1	I/O L40N_1 ♦	I/O L40P_1 ♦	I/O L22P_1	I/O	I/O L46N_2 ♦	I/O L15P_2	I/O L16N_2	I/O L16P_2	GND	VCCAUX	I/O L45N_2 ♦	I/O L45P_2 ♦	GND	GND	K																																																	
VCCINT	VCCO_1	VCCO_1	VCCO_1	VCCO_1	VCCINT	I/O L46P_2 ♦	VCCO_2	I/O L47N_2 ♦	I/O L19N_2	I/O L19P_2	I/O L20N_2	I/O L20P_2	I/O L21N_2	I/O L21P_2	L																																																	
GND	VCCINT	VCCINT	VCCINT	VCCO_2	I/O L26N_2	I/O L22N_2	I/O L22P_2	I/O L23N_2 VREF_2	I/O L23P_2	I/O L28N_2	I/O L24N_2	I/O L24P_2	I/O L50N_2 ♦	I/O L50P_2 ♦	M																																																	
GND	GND	GND	VCCINT	VCCO_2	I/O L26P_2	I/O L27N_2	I/O L27P_2	VCCO_2	I/O L28P_2	I/O L29N_2	I/O L29P_2	VCCO_2	I/O L31N_2	I/O L31P_2	N																																																	
GND	GND	GND	VCCINT	VCCO_2	I/O L32N_2	I/O L32P_2	GND	I/O L33N_2	I/O L33P_2	GND	VCCAUX	I/O L34N_2 VREF_2	I/O L34P_2	GND	P																																																	
GND	GND	GND	GND	VCCINT	I/O L35N_2	I/O L35P_2	I/O L37N_2	I/O L37P_2	I/O L38N_2	I/O L38P_2	I/O L39N_2	I/O L39P_2	I/O L40N_2	I/O L40P_2 VREF_2	R																																																	
GND	GND	GND	GND	VCCINT	I/O L35P_3	I/O L35N_3	I/O L37P_3	I/O L37N_3	I/O L38P_3	I/O L38N_3	I/O L39P_3	I/O L39N_3	I/O L40P_3	I/O L40N_3 VREF_3	T																																																	
GND	GND	GND	VCCINT	VCCO_3	I/O L32P_3	I/O L32N_3	GND	I/O L33P_3	I/O L33N_3	GND	VCCAUX	I/O L34P_3 VREF_3	I/O L34N_3	GND	U																																																	
GND	GND	GND	VCCINT	VCCO_3	I/O L27N_3	I/O L28P_3	I/O L28N_3	VCCO_3	I/O L29N_3	I/O L50P_3 ♦	I/O L50N_3 ♦	VCCO_3	I/O L31P_3	I/O L31N_3	V																																																	
GND	VCCINT	VCCINT	VCCINT	VCCO_3	I/O L27P_3	I/O L46N_3 ♦	I/O L47P_3 ♦	I/O L47N_3 ♦	I/O L29P_3	I/O L48P_3 ♦	I/O L48N_3 ♦	I/O L26P_3	I/O L26N_3	W																																																		
VCCINT	VCCO_4	VCCO_4	VCCO_4	VCCINT	I/O L20N_3	VCCO_3	I/O L21P_3	I/O L21N_3	I/O L22P_3	I/O L22N_3	I/O L23P_3 VREF_3	I/O L23N_3	I/O L24P_3	I/O L24N_3	Y																																																	
I/O	I/O L26N_4	I/O	I/O L18N_4	I/O L13P_4	I/O L20P_3	I/O L16N_3	GND	I/O L17P_3 VREF_3	I/O L17N_3	GND	VCCAUX	I/O L19P_3	I/O L19N_3	GND	A																																																	
I/O L29N_4	I/O L26P_4 VREF_4	I/O L23N_4	I/O L18P_4	VCCO_4	I/O L13N_4	I/O L08N_4	I/O L16P_3	VCCO_3	I/O	I/O L14P_3	I/O L14N_3	VCCO_3	I/O L15P_3	I/O L15N_3	A																																																	
I/O L29P_4	GND	I/O L19N_4	I/O L19P_4	I/O L14N_4	GND	I/O L08P_4	I/O L04P_4	I/O L09N_3	I/O L10P_3	I/O L10N_3	I/O L11P_3	I/O L11N_3	I/O L13P_3	I/O L13N_3 VREF_3	C																																																	
I/O L30N_4 D2	I/O L27N_4 DIN_D0	VCCO_4	I/O L19P_4	I/O L14P_4	I/O L11N_4	VCCO_4	I/O	I/O L04N_4	I/O L09P_3 VREF_3	VCCO_3	I/O L07P_3	I/O L07N_3	I/O L08P_3	I/O L08N_3	D																																																	
I/O L30P_4 D3	I/O L27P_4 D1	I/O L24N_4	I/O L20N_4	I/O L15N_4	I/O L11P_4	I/O	I/O L05N_4	I/O L34P_4 ♦	I/O L34N_4 ♦	I/O L05N_3	VCCAUX	I/O L06P_3	I/O L06N_3	GND	E																																																	
I/O VREF_4	GND	I/O L24P_4	I/O L20P_4	I/O L15P_4	GND	I/O L09N_4	I/O L05P_4	VCCO_4	I/O L03P_4	GND	I/O L05P_3	VCCO_3	I/O L04P_3	I/O L04N_3	F																																																	
I/O L31N_4 INIT_B	VCCAUX	I/O	I/O L21N_4	I/O L16N_4	VCCAUX	I/O L09P_4	I/O L06N_4 VREF_4	I/O L35N_4 ♦	VCCAUX	I/O L03N_4	I/O L02P_3	I/O L02N_3 VREF_3	I/O L03P_3	I/O L03N_3	G																																																	
I/O L31P_4 DOUT_BUSY	I/O L28N_4	VCCO_4	I/O L21P_4	I/O L16P_4	I/O L12N_4	VCCO_4	I/O L06P_4	I/O L35P_4 ♦	I/O L33N_4 ♦	VCCO_4	I/O	CLK	I/O L01P_3 VRN_3	I/O L01N_3 VRP_3	H																																																	
I/O L32N_4 GCLK1	I/O L28P_4	I/O L25N_4	I/O L22N_4 VREF_4	I/O L17N_4	I/O L12P_4	I/O L10N_4	I/O L07N_4	I/O L38N_4 ♦	I/O L33P_4 ♦	I/O L02N_4	I/O L01N_4 VRP_4	DONE	GND	GND	J																																																	
I/O L32P_4 GCLK0	GND	I/O L25P_4	I/O L22P_4	I/O L17P_4	GND	I/O L10P_4	I/O L07P_4	I/O L38P_4 ♦	GND	I/O L02P_4	I/O L01P_4 VRN_4	I/O VREF_4	GND	GND	K																																																	

Right Half of Package  
(top view)

DS099-4\_13b\_121103

## FG1156: 1156-lead Fine-pitch Ball Grid Array

The 1,156-lead fine-pitch ball grid array package, FG1156, supports two different Spartan-3 devices, namely the XC3S4000, and the XC3S5000. The XC3S2000, however, has fewer I/O pins, which consequently results in 73 unconnected pins on the FG1156 package, labeled as “N.C.” In [Table 37](#) and [Figure 16](#), these unconnected pins are indicated with a black diamond symbol (◆).

The XC3S5000 has a single unconnected package pin, ball AK31, which is also unconnected for the XC3S4000.

All the package pins appear in [Table 37](#) and are sorted by bank number, then by pin name. Pairs of pins that form a differential I/O pair appear together in the table. The table also shows the pin number for each pin and the pin type, as defined earlier.

If there is a difference between the XC3S2000 and XC3S5000 pinouts, then that difference is highlighted in [Table 37](#). If the table entry is shaded grey, then there is an unconnected pin on the XC3S2000 that maps to a user-I/O pin on the XC3S4000 and XC3S5000. If the table entry is shaded tan, which only occurs on ball L29 in I/O Bank 2, then the unconnected pin on XC3S4000 maps to a VREF-type pin on the XC3S5000. If the other VREF\_2 pins all connect to a voltage reference to support a special I/O standard, then also connect the N.C. pin on the XC3S4000 to the same VREF\_2 voltage. This provides maximum flexibility as you could potentially migrate a design from the XC3S4000 to the XC3S5000 FPGA without changing the printed circuit board.

### Pinout Table

Table 37: FG1156 Package Pinout

Bank	XC3S4000 Pin Name	XC3S5000 Pin Name	FG1156 Pin Number	Type
0	IO	IO	B9	I/O
0	IO	IO	E17	I/O
0	IO	IO	F6	I/O
0	IO	IO	F8	I/O
0	IO	IO	G12	I/O
0	IO	IO	H8	I/O
0	IO	IO	H9	I/O
0	IO	IO	J11	I/O
0	N.C. (◆)	IO	J9	I/O
0	N.C. (◆)	IO	K11	I/O
0	IO	IO	K13	I/O
0	IO	IO	K16	I/O
0	IO	IO	K17	I/O
0	IO	IO	L13	I/O

Table 37: FG1156 Package Pinout (Continued)

Bank	XC3S4000 Pin Name	XC3S5000 Pin Name	FG1156 Pin Number	Type
0	IO	IO	L16	I/O
0	IO	IO	L17	I/O
0	IO/VREF_0	IO/VREF_0	D5	VREF
0	IO/VREF_0	IO/VREF_0	E10	VREF
0	IO/VREF_0	IO/VREF_0	J14	VREF
0	IO/VREF_0	IO/VREF_0	L15	VREF
0	IO_L01N_0/ VRP_0	IO_L01N_0/ VRP_0	B3	DCI
0	IO_L01P_0/ VRN_0	IO_L01P_0/ VRN_0	A3	DCI
0	IO_L02N_0	IO_L02N_0	B4	I/O
0	IO_L02P_0	IO_L02P_0	A4	I/O
0	IO_L03N_0	IO_L03N_0	C5	I/O
0	IO_L03P_0	IO_L03P_0	B5	I/O
0	IO_L04N_0	IO_L04N_0	D6	I/O
0	IO_L04P_0	IO_L04P_0	C6	I/O
0	IO_L05N_0	IO_L05N_0	B6	I/O
0	IO_L05P_0/ VREF_0	IO_L05P_0/ VREF_0	A6	VREF
0	IO_L06N_0	IO_L06N_0	F7	I/O
0	IO_L06P_0	IO_L06P_0	E7	I/O
0	IO_L07N_0	IO_L07N_0	G9	I/O
0	IO_L07P_0	IO_L07P_0	F9	I/O
0	IO_L08N_0	IO_L08N_0	D9	I/O
0	IO_L08P_0	IO_L08P_0	C9	I/O
0	IO_L09N_0	IO_L09N_0	J10	I/O
0	IO_L09P_0	IO_L09P_0	H10	I/O
0	IO_L10N_0	IO_L10N_0	G10	I/O
0	IO_L10P_0	IO_L10P_0	F10	I/O
0	IO_L11N_0	IO_L11N_0	L12	I/O
0	IO_L11P_0	IO_L11P_0	K12	I/O
0	IO_L12N_0	IO_L12N_0	J12	I/O
0	IO_L12P_0	IO_L12P_0	H12	I/O
0	IO_L13N_0	IO_L13N_0	F12	I/O
0	IO_L13P_0	IO_L13P_0	E12	I/O
0	IO_L14N_0	IO_L14N_0	D12	I/O
0	IO_L14P_0	IO_L14P_0	C12	I/O
0	IO_L15N_0	IO_L15N_0	B12	I/O
0	IO_L15P_0	IO_L15P_0	A12	I/O
0	IO_L16N_0	IO_L16N_0	H13	I/O
0	IO_L16P_0	IO_L16P_0	G13	I/O
0	IO_L17N_0	IO_L17N_0	D13	I/O

Table 37: FG1156 Package Pinout (Continued)

Bank	XC3S4000 Pin Name	XC3S5000 Pin Name	FG1156 Pin Number	Type
0	IO_L17P_0	IO_L17P_0	C13	I/O
0	IO_L18N_0	IO_L18N_0	L14	I/O
0	IO_L18P_0	IO_L18P_0	K14	I/O
0	IO_L19N_0	IO_L19N_0	H14	I/O
0	IO_L19P_0	IO_L19P_0	G14	I/O
0	IO_L20N_0	IO_L20N_0	F14	I/O
0	IO_L20P_0	IO_L20P_0	E14	I/O
0	IO_L21N_0	IO_L21N_0	D14	I/O
0	IO_L21P_0	IO_L21P_0	C14	I/O
0	IO_L22N_0	IO_L22N_0	B14	I/O
0	IO_L22P_0	IO_L22P_0	A14	I/O
0	IO_L23N_0	IO_L23N_0	K15	I/O
0	IO_L23P_0	IO_L23P_0	J15	I/O
0	IO_L24N_0	IO_L24N_0	G15	I/O
0	IO_L24P_0	IO_L24P_0	F15	I/O
0	IO_L25N_0	IO_L25N_0	D15	I/O
0	IO_L25P_0	IO_L25P_0	C15	I/O
0	IO_L26N_0	IO_L26N_0	B15	I/O
0	IO_L26P_0/ VREF_0	IO_L26P_0/ VREF_0	A15	VREF
0	IO_L27N_0	IO_L27N_0	G16	I/O
0	IO_L27P_0	IO_L27P_0	F16	I/O
0	IO_L28N_0	IO_L28N_0	C16	I/O
0	IO_L28P_0	IO_L28P_0	B16	I/O
0	IO_L29N_0	IO_L29N_0	J17	I/O
0	IO_L29P_0	IO_L29P_0	H17	I/O
0	IO_L30N_0	IO_L30N_0	G17	I/O
0	IO_L30P_0	IO_L30P_0	F17	I/O
0	IO_L31N_0	IO_L31N_0	D17	I/O
0	IO_L31P_0/ VREF_0	IO_L31P_0/ VREF_0	C17	VREF
0	IO_L32N_0/ GCLK7	IO_L32N_0/ GCLK7	B17	GCLK
0	IO_L32P_0/ GCLK6	IO_L32P_0/ GCLK6	A17	GCLK
0	N.C. (◆)	IO_L33N_0	D7	I/O
0	N.C. (◆)	IO_L33P_0	C7	I/O
0	N.C. (◆)	IO_L34N_0	B7	I/O
0	N.C. (◆)	IO_L34P_0	A7	I/O
0	IO_L35N_0	IO_L35N_0	E8	I/O
0	IO_L35P_0	IO_L35P_0	D8	I/O
0	IO_L36N_0	IO_L36N_0	B8	I/O

Table 37: FG1156 Package Pinout (Continued)

Bank	XC3S4000 Pin Name	XC3S5000 Pin Name	FG1156 Pin Number	Type
0	IO_L36P_0	IO_L36P_0	A8	I/O
0	IO_L37N_0	IO_L37N_0	D10	I/O
0	IO_L37P_0	IO_L37P_0	C10	I/O
0	IO_L38N_0	IO_L38N_0	B10	I/O
0	IO_L38P_0	IO_L38P_0	A10	I/O
0	N.C. (◆)	IO_L39N_0	G11	I/O
0	N.C. (◆)	IO_L39P_0	F11	I/O
0	N.C. (◆)	IO_L40N_0	B11	I/O
0	N.C. (◆)	IO_L40P_0	A11	I/O
0	VCCO_0	VCCO_0	B13	VCCO
0	VCCO_0	VCCO_0	C4	VCCO
0	VCCO_0	VCCO_0	C8	VCCO
0	VCCO_0	VCCO_0	D11	VCCO
0	VCCO_0	VCCO_0	D16	VCCO
0	VCCO_0	VCCO_0	F13	VCCO
0	VCCO_0	VCCO_0	G8	VCCO
0	VCCO_0	VCCO_0	H11	VCCO
0	VCCO_0	VCCO_0	H15	VCCO
0	VCCO_0	VCCO_0	M13	VCCO
0	VCCO_0	VCCO_0	M14	VCCO
0	VCCO_0	VCCO_0	M15	VCCO
0	VCCO_0	VCCO_0	M16	VCCO
1	IO	IO	B26	I/O
1	IO	IO	A18	I/O
1	IO	IO	C23	I/O
1	IO	IO	E21	I/O
1	IO	IO	E25	I/O
1	IO	IO	F18	I/O
1	IO	IO	F27	I/O
1	IO	IO	F29	I/O
1	IO	IO	H23	I/O
1	IO	IO	H26	I/O
1	N.C. (◆)	IO	J26	I/O
1	IO	IO	K19	I/O
1	IO	IO	L19	I/O
1	IO	IO	L20	I/O
1	IO	IO	L21	I/O
1	N.C. (◆)	IO	L23	I/O
1	IO	IO	L24	I/O
1	IO/VREF_1	IO/VREF_1	D30	VREF
1	IO/VREF_1	IO/VREF_1	K21	VREF

Table 37: FG1156 Package Pinout (Continued)

Bank	XC3S4000 Pin Name	XC3S5000 Pin Name	FG1156 Pin Number	Type
1	IO/VREF_1	IO/VREF_1	L18	VREF
1	IO_L01N_1/ VRP_1	IO_L01N_1/ VRP_1	A32	DCI
1	IO_L01P_1/ VRN_1	IO_L01P_1/ VRN_1	B32	DCI
1	IO_L02N_1	IO_L02N_1	A31	I/O
1	IO_L02P_1	IO_L02P_1	B31	I/O
1	IO_L03N_1	IO_L03N_1	B30	I/O
1	IO_L03P_1	IO_L03P_1	C30	I/O
1	IO_L04N_1	IO_L04N_1	C29	I/O
1	IO_L04P_1	IO_L04P_1	D29	I/O
1	IO_L05N_1	IO_L05N_1	A29	I/O
1	IO_L05P_1	IO_L05P_1	B29	I/O
1	IO_L06N_1/ VREF_1	IO_L06N_1/ VREF_1	E28	VREF
1	IO_L06P_1	IO_L06P_1	F28	I/O
1	IO_L07N_1	IO_L07N_1	D27	I/O
1	IO_L07P_1	IO_L07P_1	E27	I/O
1	IO_L08N_1	IO_L08N_1	A27	I/O
1	IO_L08P_1	IO_L08P_1	B27	I/O
1	IO_L09N_1	IO_L09N_1	F26	I/O
1	IO_L09P_1	IO_L09P_1	G26	I/O
1	IO_L10N_1/ VREF_1	IO_L10N_1/ VREF_1	C26	VREF
1	IO_L10P_1	IO_L10P_1	D26	I/O
1	IO_L11N_1	IO_L11N_1	H25	I/O
1	IO_L11P_1	IO_L11P_1	J25	I/O
1	IO_L12N_1	IO_L12N_1	F25	I/O
1	IO_L12P_1	IO_L12P_1	G25	I/O
1	IO_L13N_1	IO_L13N_1	C25	I/O
1	IO_L13P_1	IO_L13P_1	D25	I/O
1	IO_L14N_1	IO_L14N_1	A25	I/O
1	IO_L14P_1	IO_L14P_1	B25	I/O
1	IO_L15N_1	IO_L15N_1	A24	I/O
1	IO_L15P_1	IO_L15P_1	B24	I/O
1	IO_L16N_1	IO_L16N_1	J23	I/O
1	IO_L16P_1	IO_L16P_1	K23	I/O
1	IO_L17N_1/ VREF_1	IO_L17N_1/ VREF_1	F23	VREF
1	IO_L17P_1	IO_L17P_1	G23	I/O
1	IO_L18N_1	IO_L18N_1	D23	I/O
1	IO_L18P_1	IO_L18P_1	E23	I/O

Table 37: FG1156 Package Pinout (Continued)

Bank	XC3S4000 Pin Name	XC3S5000 Pin Name	FG1156 Pin Number	Type
1	IO_L19N_1	IO_L19N_1	A23	I/O
1	IO_L19P_1	IO_L19P_1	B23	I/O
1	IO_L20N_1	IO_L20N_1	K22	I/O
1	IO_L20P_1	IO_L20P_1	L22	I/O
1	IO_L21N_1	IO_L21N_1	G22	I/O
1	IO_L21P_1	IO_L21P_1	H22	I/O
1	IO_L22N_1	IO_L22N_1	C22	I/O
1	IO_L22P_1	IO_L22P_1	D22	I/O
1	IO_L23N_1	IO_L23N_1	H21	I/O
1	IO_L23P_1	IO_L23P_1	J21	I/O
1	IO_L24N_1	IO_L24N_1	F21	I/O
1	IO_L24P_1	IO_L24P_1	G21	I/O
1	IO_L25N_1	IO_L25N_1	C21	I/O
1	IO_L25P_1	IO_L25P_1	D21	I/O
1	IO_L26N_1	IO_L26N_1	A21	I/O
1	IO_L26P_1	IO_L26P_1	B21	I/O
1	IO_L27N_1	IO_L27N_1	F19	I/O
1	IO_L27P_1	IO_L27P_1	G19	I/O
1	IO_L28N_1	IO_L28N_1	B19	I/O
1	IO_L28P_1	IO_L28P_1	C19	I/O
1	IO_L29N_1	IO_L29N_1	J18	I/O
1	IO_L29P_1	IO_L29P_1	K18	I/O
1	IO_L30N_1	IO_L30N_1	G18	I/O
1	IO_L30P_1	IO_L30P_1	H18	I/O
1	IO_L31N_1/ VREF_1	IO_L31N_1/ VREF_1	D18	VREF
1	IO_L31P_1	IO_L31P_1	E18	I/O
1	IO_L32N_1/ GCLK5	IO_L32N_1/ GCLK5	B18	GCLK
1	IO_L32P_1/ GCLK4	IO_L32P_1/ GCLK4	C18	GCLK
1	N.C. (◆)	IO_L33N_1	C28	I/O
1	N.C. (◆)	IO_L33P_1	D28	I/O
1	N.C. (◆)	IO_L34N_1	A28	I/O
1	N.C. (◆)	IO_L34P_1	B28	I/O
1	N.C. (◆)	IO_L35N_1	J24	I/O
1	N.C. (◆)	IO_L35P_1	K24	I/O
1	N.C. (◆)	IO_L36N_1	F24	I/O
1	N.C. (◆)	IO_L36P_1	G24	I/O
1	IO_L37N_1	IO_L37N_1	J20	I/O
1	IO_L37P_1	IO_L37P_1	K20	I/O
1	IO_L38N_1	IO_L38N_1	F20	I/O

Table 37: FG1156 Package Pinout (Continued)

Bank	XC3S4000 Pin Name	XC3S5000 Pin Name	FG1156 Pin Number	Type
1	IO_L38P_1	IO_L38P_1	G20	I/O
1	IO_L39N_1	IO_L39N_1	C20	I/O
1	IO_L39P_1	IO_L39P_1	D20	I/O
1	IO_L40N_1	IO_L40N_1	A20	I/O
1	IO_L40P_1	IO_L40P_1	B20	I/O
1	VCCO_1	VCCO_1	B22	VCCO
1	VCCO_1	VCCO_1	C27	VCCO
1	VCCO_1	VCCO_1	C31	VCCO
1	VCCO_1	VCCO_1	D19	VCCO
1	VCCO_1	VCCO_1	D24	VCCO
1	VCCO_1	VCCO_1	F22	VCCO
1	VCCO_1	VCCO_1	G27	VCCO
1	VCCO_1	VCCO_1	H20	VCCO
1	VCCO_1	VCCO_1	H24	VCCO
1	VCCO_1	VCCO_1	M19	VCCO
1	VCCO_1	VCCO_1	M20	VCCO
1	VCCO_1	VCCO_1	M21	VCCO
1	VCCO_1	VCCO_1	M22	VCCO
2	IO	IO	G33	I/O
2	IO	IO	G34	I/O
2	IO	IO	U25	I/O
2	IO	IO	U26	I/O
2	IO_L01N_2/ VRP_2	IO_L01N_2/ VRP_2	C33	DCI
2	IO_L01P_2/ VRN_2	IO_L01P_2/ VRN_2	C34	DCI
2	IO_L02N_2	IO_L02N_2	D33	I/O
2	IO_L02P_2	IO_L02P_2	D34	I/O
2	IO_L03N_2/ VREF_2	IO_L03N_2/ VREF_2	E32	VREF
2	IO_L03P_2	IO_L03P_2	E33	I/O
2	IO_L04N_2	IO_L04N_2	F31	I/O
2	IO_L04P_2	IO_L04P_2	F32	I/O
2	IO_L05N_2	IO_L05N_2	G29	I/O
2	IO_L05P_2	IO_L05P_2	G30	I/O
2	IO_L06N_2	IO_L06N_2	H29	I/O
2	IO_L06P_2	IO_L06P_2	H30	I/O
2	IO_L07N_2	IO_L07N_2	H33	I/O
2	IO_L07P_2	IO_L07P_2	H34	I/O
2	IO_L08N_2	IO_L08N_2	J28	I/O
2	IO_L08P_2	IO_L08P_2	J29	I/O

Table 37: FG1156 Package Pinout (Continued)

Bank	XC3S4000 Pin Name	XC3S5000 Pin Name	FG1156 Pin Number	Type
2	IO_L09N_2/ VREF_2	IO_L09N_2/ VREF_2	H31	VREF
2	IO_L09P_2	IO_L09P_2	J31	I/O
2	IO_L10N_2	IO_L10N_2	J32	I/O
2	IO_L10P_2	IO_L10P_2	J33	I/O
2	IO_L11N_2	IO_L11N_2	J27	I/O
2	IO_L11P_2	IO_L11P_2	K26	I/O
2	IO_L12N_2	IO_L12N_2	K27	I/O
2	IO_L12P_2	IO_L12P_2	K28	I/O
2	IO_L13N_2	IO_L13N_2	K29	I/O
2	IO_L13P_2/ VREF_2	IO_L13P_2/ VREF_2	K30	VREF
2	IO_L14N_2	IO_L14N_2	K31	I/O
2	IO_L14P_2	IO_L14P_2	K32	I/O
2	IO_L15N_2	IO_L15N_2	K33	I/O
2	IO_L15P_2	IO_L15P_2	K34	I/O
2	IO_L16N_2	IO_L16N_2	L25	I/O
2	IO_L16P_2	IO_L16P_2	L26	I/O
2	N.C. (◆)	IO_L17N_2	L28	I/O
2	N.C. (◆)	IO_L17P_2/ VREF_2	L29	VREF
2	IO_L19N_2	IO_L19N_2	M29	I/O
2	IO_L19P_2	IO_L19P_2	M30	I/O
2	IO_L20N_2	IO_L20N_2	M31	I/O
2	IO_L20P_2	IO_L20P_2	M32	I/O
2	IO_L21N_2	IO_L21N_2	M26	I/O
2	IO_L21P_2	IO_L21P_2	N25	I/O
2	IO_L22N_2	IO_L22N_2	N27	I/O
2	IO_L22P_2	IO_L22P_2	N28	I/O
2	IO_L23N_2/ VREF_2	IO_L23N_2/ VREF_2	N31	VREF
2	IO_L23P_2	IO_L23P_2	N32	I/O
2	IO_L24N_2	IO_L24N_2	N24	I/O
2	IO_L24P_2	IO_L24P_2	P24	I/O
2	IO_L26N_2	IO_L26N_2	P29	I/O
2	IO_L26P_2	IO_L26P_2	P30	I/O
2	IO_L27N_2	IO_L27N_2	P31	I/O
2	IO_L27P_2	IO_L27P_2	P32	I/O
2	IO_L28N_2	IO_L28N_2	P33	I/O
2	IO_L28P_2	IO_L28P_2	P34	I/O
2	IO_L29N_2	IO_L29N_2	R24	I/O
2	IO_L29P_2	IO_L29P_2	R25	I/O

Table 37: FG1156 Package Pinout (Continued)

Bank	XC3S4000 Pin Name	XC3S5000 Pin Name	FG1156 Pin Number	Type
2	IO_L30N_2	IO_L30N_2	R28	I/O
2	IO_L30P_2	IO_L30P_2	R29	I/O
2	IO_L31N_2	IO_L31N_2	R31	I/O
2	IO_L31P_2	IO_L31P_2	R32	I/O
2	IO_L32N_2	IO_L32N_2	R33	I/O
2	IO_L32P_2	IO_L32P_2	R34	I/O
2	IO_L33N_2	IO_L33N_2	R26	I/O
2	IO_L33P_2	IO_L33P_2	T25	I/O
2	IO_L34N_2/ VREF_2	IO_L34N_2/ VREF_2	T28	VREF
2	IO_L34P_2	IO_L34P_2	T29	I/O
2	IO_L35N_2	IO_L35N_2	T32	I/O
2	IO_L35P_2	IO_L35P_2	T33	I/O
2	IO_L37N_2	IO_L37N_2	U27	I/O
2	IO_L37P_2	IO_L37P_2	U28	I/O
2	IO_L38N_2	IO_L38N_2	U29	I/O
2	IO_L38P_2	IO_L38P_2	U30	I/O
2	IO_L39N_2	IO_L39N_2	U31	I/O
2	IO_L39P_2	IO_L39P_2	U32	I/O
2	IO_L40N_2	IO_L40N_2	U33	I/O
2	IO_L40P_2/ VREF_2	IO_L40P_2/ VREF_2	U34	VREF
2	IO_L41N_2	IO_L41N_2	F33	I/O
2	IO_L41P_2	IO_L41P_2	F34	I/O
2	N.C. (◆)	IO_L42N_2	G31	I/O
2	N.C. (◆)	IO_L42P_2	G32	I/O
2	IO_L45N_2	IO_L45N_2	L33	I/O
2	IO_L45P_2	IO_L45P_2	L34	I/O
2	IO_L46N_2	IO_L46N_2	M24	I/O
2	IO_L46P_2	IO_L46P_2	M25	I/O
2	IO_L47N_2	IO_L47N_2	M27	I/O
2	IO_L47P_2	IO_L47P_2	M28	I/O
2	IO_L48N_2	IO_L48N_2	M33	I/O
2	IO_L48P_2	IO_L48P_2	M34	I/O
2	N.C. (◆)	IO_L49N_2	P25	I/O
2	N.C. (◆)	IO_L49P_2	P26	I/O
2	IO_L50N_2	IO_L50N_2	P27	I/O
2	IO_L50P_2	IO_L50P_2	P28	I/O
2	N.C. (◆)	IO_L51N_2	T24	I/O
2	N.C. (◆)	IO_L51P_2	U24	I/O
2	VCCO_2	VCCO_2	D32	VCCO
2	VCCO_2	VCCO_2	H28	VCCO

Table 37: FG1156 Package Pinout (Continued)

Bank	XC3S4000 Pin Name	XC3S5000 Pin Name	FG1156 Pin Number	Type
2	VCCO_2	VCCO_2	H32	VCCO
2	VCCO_2	VCCO_2	L27	VCCO
2	VCCO_2	VCCO_2	L31	VCCO
2	VCCO_2	VCCO_2	N23	VCCO
2	VCCO_2	VCCO_2	N29	VCCO
2	VCCO_2	VCCO_2	N33	VCCO
2	VCCO_2	VCCO_2	P23	VCCO
2	VCCO_2	VCCO_2	R23	VCCO
2	VCCO_2	VCCO_2	R27	VCCO
2	VCCO_2	VCCO_2	T23	VCCO
2	VCCO_2	VCCO_2	T31	VCCO
3	IO	IO	AH33	I/O
3	IO	IO	AH34	I/O
3	IO	IO	V25	I/O
3	IO	IO	V26	I/O
3	IO_L01N_3/ VRP_3	IO_L01N_3/ VRP_3	AM34	DCI
3	IO_L01P_3/ VRN_3	IO_L01P_3/ VRN_3	AM33	DCI
3	IO_L02N_3/ VREF_3	IO_L02N_3/ VREF_3	AL34	VREF
3	IO_L02P_3	IO_L02P_3	AL33	I/O
3	IO_L03N_3	IO_L03N_3	AK33	I/O
3	IO_L03P_3	IO_L03P_3	AK32	I/O
3	IO_L04N_3	IO_L04N_3	AJ32	I/O
3	IO_L04P_3	IO_L04P_3	AJ31	I/O
3	IO_L05N_3	IO_L05N_3	AJ34	I/O
3	IO_L05P_3	IO_L05P_3	AJ33	I/O
3	IO_L06N_3	IO_L06N_3	AH30	I/O
3	IO_L06P_3	IO_L06P_3	AH29	I/O
3	IO_L07N_3	IO_L07N_3	AG30	I/O
3	IO_L07P_3	IO_L07P_3	AG29	I/O
3	IO_L08N_3	IO_L08N_3	AG34	I/O
3	IO_L08P_3	IO_L08P_3	AG33	I/O
3	IO_L09N_3	IO_L09N_3	AF29	I/O
3	IO_L09P_3/ VREF_3	IO_L09P_3/ VREF_3	AF28	VREF
3	IO_L10N_3	IO_L10N_3	AF31	I/O
3	IO_L10P_3	IO_L10P_3	AG31	I/O
3	IO_L11N_3	IO_L11N_3	AF33	I/O
3	IO_L11P_3	IO_L11P_3	AF32	I/O
3	IO_L12N_3	IO_L12N_3	AE26	I/O



**Table 37: FG1156 Package Pinout (Continued)**

Bank	XC3S4000 Pin Name	XC3S5000 Pin Name	FG1156 Pin Number	Type
3	IO_L12P_3	IO_L12P_3	AF27	I/O
3	IO_L13N_3/ VREF_3	IO_L13N_3/ VREF_3	AE28	VREF
3	IO_L13P_3	IO_L13P_3	AE27	I/O
3	IO_L14N_3	IO_L14N_3	AE30	I/O
3	IO_L14P_3	IO_L14P_3	AE29	I/O
3	IO_L15N_3	IO_L15N_3	AE32	I/O
3	IO_L15P_3	IO_L15P_3	AE31	I/O
3	IO_L16N_3	IO_L16N_3	AE34	I/O
3	IO_L16P_3	IO_L16P_3	AE33	I/O
3	IO_L17N_3	IO_L17N_3	AD26	I/O
3	IO_L17P_3/ VREF_3	IO_L17P_3/ VREF_3	AD25	VREF
3	IO_L19N_3	IO_L19N_3	AD34	I/O
3	IO_L19P_3	IO_L19P_3	AD33	I/O
3	IO_L20N_3	IO_L20N_3	AC25	I/O
3	IO_L20P_3	IO_L20P_3	AC24	I/O
3	IO_L21N_3	IO_L21N_3	AC28	I/O
3	IO_L21P_3	IO_L21P_3	AC27	I/O
3	IO_L22N_3	IO_L22N_3	AC30	I/O
3	IO_L22P_3	IO_L22P_3	AC29	I/O
3	IO_L23N_3	IO_L23N_3	AC32	I/O
3	IO_L23P_3/ VREF_3	IO_L23P_3/ VREF_3	AC31	VREF
3	IO_L24N_3	IO_L24N_3	AB25	I/O
3	IO_L24P_3	IO_L24P_3	AC26	I/O
3	IO_L26N_3	IO_L26N_3	AA28	I/O
3	IO_L26P_3	IO_L26P_3	AA27	I/O
3	IO_L27N_3	IO_L27N_3	AA30	I/O
3	IO_L27P_3	IO_L27P_3	AA29	I/O
3	IO_L28N_3	IO_L28N_3	AA32	I/O
3	IO_L28P_3	IO_L28P_3	AA31	I/O
3	IO_L29N_3	IO_L29N_3	AA34	I/O
3	IO_L29P_3	IO_L29P_3	AA33	I/O
3	IO_L30N_3	IO_L30N_3	Y29	I/O
3	IO_L30P_3	IO_L30P_3	Y28	I/O
3	IO_L31N_3	IO_L31N_3	Y32	I/O
3	IO_L31P_3	IO_L31P_3	Y31	I/O
3	IO_L32N_3	IO_L32N_3	Y34	I/O
3	IO_L32P_3	IO_L32P_3	Y33	I/O
3	IO_L33N_3	IO_L33N_3	W25	I/O
3	IO_L33P_3	IO_L33P_3	Y26	I/O

**Table 37: FG1156 Package Pinout (Continued)**

Bank	XC3S4000 Pin Name	XC3S5000 Pin Name	FG1156 Pin Number	Type
3	IO_L34N_3	IO_L34N_3	W29	I/O
3	IO_L34P_3/ VREF_3	IO_L34P_3/ VREF_3	W28	VREF
3	IO_L35N_3	IO_L35N_3	W33	I/O
3	IO_L35P_3	IO_L35P_3	W32	I/O
3	IO_L37N_3	IO_L37N_3	V28	I/O
3	IO_L37P_3	IO_L37P_3	V27	I/O
3	IO_L38N_3	IO_L38N_3	V30	I/O
3	IO_L38P_3	IO_L38P_3	V29	I/O
3	IO_L39N_3	IO_L39N_3	V32	I/O
3	IO_L39P_3	IO_L39P_3	V31	I/O
3	IO_L40N_3/ VREF_3	IO_L40N_3/ VREF_3	V34	VREF
3	IO_L40P_3	IO_L40P_3	V33	I/O
3	N.C. (◆)	IO_L41N_3	AH32	I/O
3	N.C. (◆)	IO_L41P_3	AH31	I/O
3	N.C. (◆)	IO_L44N_3	AD29	I/O
3	N.C. (◆)	IO_L44P_3	AD28	I/O
3	IO_L45N_3	IO_L45N_3	AC34	I/O
3	IO_L45P_3	IO_L45P_3	AC33	I/O
3	IO_L46N_3	IO_L46N_3	AB28	I/O
3	IO_L46P_3	IO_L46P_3	AB27	I/O
3	IO_L47N_3	IO_L47N_3	AB32	I/O
3	IO_L47P_3	IO_L47P_3	AB31	I/O
3	IO_L48N_3	IO_L48N_3	AA24	I/O
3	IO_L48P_3	IO_L48P_3	AB24	I/O
3	N.C. (◆)	IO_L49N_3	AA26	I/O
3	N.C. (◆)	IO_L49P_3	AA25	I/O
3	IO_L50N_3	IO_L50N_3	Y25	I/O
3	IO_L50P_3	IO_L50P_3	Y24	I/O
3	N.C. (◆)	IO_L51N_3	V24	I/O
3	N.C. (◆)	IO_L51P_3	W24	I/O
3	VCCO_3	VCCO_3	AA23	VCCO
3	VCCO_3	VCCO_3	AB23	VCCO
3	VCCO_3	VCCO_3	AB29	VCCO
3	VCCO_3	VCCO_3	AB33	VCCO
3	VCCO_3	VCCO_3	AD27	VCCO
3	VCCO_3	VCCO_3	AD31	VCCO
3	VCCO_3	VCCO_3	AG28	VCCO
3	VCCO_3	VCCO_3	AG32	VCCO
3	VCCO_3	VCCO_3	AL32	VCCO
3	VCCO_3	VCCO_3	W23	VCCO

Table 37: FG1156 Package Pinout (Continued)

Bank	XC3S4000 Pin Name	XC3S5000 Pin Name	FG1156 Pin Number	Type
3	VCCO_3	VCCO_3	W31	VCCO
3	VCCO_3	VCCO_3	Y23	VCCO
3	VCCO_3	VCCO_3	Y27	VCCO
4	IO	IO	AD18	I/O
4	IO	IO	AD19	I/O
4	IO	IO	AD20	I/O
4	IO	IO	AD22	I/O
4	IO	IO	AE18	I/O
4	IO	IO	AE19	I/O
4	IO	IO	AE22	I/O
4	N.C. (◆)	IO	AE24	I/O
4	IO	IO	AF24	I/O
4	N.C. (◆)	IO	AF26	I/O
4	IO	IO	AG26	I/O
4	IO	IO	AG27	I/O
4	IO	IO	AJ27	I/O
4	IO	IO	AJ29	I/O
4	IO	IO	AK25	I/O
4	IO	IO	AN26	I/O
4	IO/VREF_4	IO/VREF_4	AF21	VREF
4	IO/VREF_4	IO/VREF_4	AH23	VREF
4	IO/VREF_4	IO/VREF_4	AK18	VREF
4	IO/VREF_4	IO/VREF_4	AL30	VREF
4	IO_L01N_4/ VRP_4	IO_L01N_4/ VRP_4	AN32	DCI
4	IO_L01P_4/ VRN_4	IO_L01P_4/ VRN_4	AP32	DCI
4	IO_L02N_4	IO_L02N_4	AN31	I/O
4	IO_L02P_4	IO_L02P_4	AP31	I/O
4	IO_L03N_4	IO_L03N_4	AM30	I/O
4	IO_L03P_4	IO_L03P_4	AN30	I/O
4	IO_L04N_4	IO_L04N_4	AN27	I/O
4	IO_L04P_4	IO_L04P_4	AP27	I/O
4	IO_L05N_4	IO_L05N_4	AH26	I/O
4	IO_L05P_4	IO_L05P_4	AJ26	I/O
4	IO_L06N_4/ VREF_4	IO_L06N_4/ VREF_4	AL26	VREF
4	IO_L06P_4	IO_L06P_4	AM26	I/O
4	IO_L07N_4	IO_L07N_4	AF25	I/O
4	IO_L07P_4	IO_L07P_4	AG25	I/O
4	IO_L08N_4	IO_L08N_4	AH25	I/O
4	IO_L08P_4	IO_L08P_4	AJ25	I/O

Table 37: FG1156 Package Pinout (Continued)

Bank	XC3S4000 Pin Name	XC3S5000 Pin Name	FG1156 Pin Number	Type
4	IO_L09N_4	IO_L09N_4	AL25	I/O
4	IO_L09P_4	IO_L09P_4	AM25	I/O
4	IO_L10N_4	IO_L10N_4	AN25	I/O
4	IO_L10P_4	IO_L10P_4	AP25	I/O
4	IO_L11N_4	IO_L11N_4	AD23	I/O
4	IO_L11P_4	IO_L11P_4	AE23	I/O
4	IO_L12N_4	IO_L12N_4	AF23	I/O
4	IO_L12P_4	IO_L12P_4	AG23	I/O
4	IO_L13N_4	IO_L13N_4	AJ23	I/O
4	IO_L13P_4	IO_L13P_4	AK23	I/O
4	IO_L14N_4	IO_L14N_4	AL23	I/O
4	IO_L14P_4	IO_L14P_4	AM23	I/O
4	IO_L15N_4	IO_L15N_4	AN23	I/O
4	IO_L15P_4	IO_L15P_4	AP23	I/O
4	IO_L16N_4	IO_L16N_4	AG22	I/O
4	IO_L16P_4	IO_L16P_4	AH22	I/O
4	IO_L17N_4	IO_L17N_4	AL22	I/O
4	IO_L17P_4	IO_L17P_4	AM22	I/O
4	IO_L18N_4	IO_L18N_4	AD21	I/O
4	IO_L18P_4	IO_L18P_4	AE21	I/O
4	IO_L19N_4	IO_L19N_4	AG21	I/O
4	IO_L19P_4	IO_L19P_4	AH21	I/O
4	IO_L20N_4	IO_L20N_4	AJ21	I/O
4	IO_L20P_4	IO_L20P_4	AK21	I/O
4	IO_L21N_4	IO_L21N_4	AL21	I/O
4	IO_L21P_4	IO_L21P_4	AM21	I/O
4	IO_L22N_4/ VREF_4	IO_L22N_4/ VREF_4	AN21	VREF
4	IO_L22P_4	IO_L22P_4	AP21	I/O
4	IO_L23N_4	IO_L23N_4	AE20	I/O
4	IO_L23P_4	IO_L23P_4	AF20	I/O
4	IO_L24N_4	IO_L24N_4	AH20	I/O
4	IO_L24P_4	IO_L24P_4	AJ20	I/O
4	IO_L25N_4	IO_L25N_4	AL20	I/O
4	IO_L25P_4	IO_L25P_4	AM20	I/O
4	IO_L26N_4	IO_L26N_4	AN20	I/O
4	IO_L26P_4/ VREF_4	IO_L26P_4/ VREF_4	AP20	VREF
4	IO_L27N_4/ DIN/D0	IO_L27N_4/ DIN/D0	AH19	DUAL
4	IO_L27P_4/ D1	IO_L27P_4/ D1	AJ19	DUAL

**Table 37: FG1156 Package Pinout (Continued)**

Bank	XC3S4000 Pin Name	XC3S5000 Pin Name	FG1156 Pin Number	Type
4	IO_L28N_4	IO_L28N_4	AM19	I/O
4	IO_L28P_4	IO_L28P_4	AN19	I/O
4	IO_L29N_4	IO_L29N_4	AF18	I/O
4	IO_L29P_4	IO_L29P_4	AG18	I/O
4	IO_L30N_4/ D2	IO_L30N_4/ D2	AH18	DUAL
4	IO_L30P_4/ D3	IO_L30P_4/ D3	AJ18	DUAL
4	IO_L31N_4/ INIT_B	IO_L31N_4/ INIT_B	AL18	DUAL
4	IO_L31P_4/ DOUT/BUSY	IO_L31P_4/ DOUT/BUSY	AM18	DUAL
4	IO_L32N_4/ GCLK1	IO_L32N_4/ GCLK1	AN18	GCLK
4	IO_L32P_4/ GCLK0	IO_L32P_4/ GCLK0	AP18	GCLK
4	IO_L33N_4	IO_L33N_4	AL29	I/O
4	IO_L33P_4	IO_L33P_4	AM29	I/O
4	IO_L34N_4	IO_L34N_4	AN29	I/O
4	IO_L34P_4	IO_L34P_4	AP29	I/O
4	IO_L35N_4	IO_L35N_4	AJ28	I/O
4	IO_L35P_4	IO_L35P_4	AK28	I/O
4	N.C. (◆)	IO_L36N_4	AL28	I/O
4	N.C. (◆)	IO_L36P_4	AM28	I/O
4	N.C. (◆)	IO_L37N_4	AN28	I/O
4	N.C. (◆)	IO_L37P_4	AP28	I/O
4	IO_L38N_4	IO_L38N_4	AK27	I/O
4	IO_L38P_4	IO_L38P_4	AL27	I/O
4	N.C. (◆)	IO_L39N_4	AH24	I/O
4	N.C. (◆)	IO_L39P_4	AJ24	I/O
4	N.C. (◆)	IO_L40N_4	AN24	I/O
4	N.C. (◆)	IO_L40P_4	AP24	I/O
4	VCCO_4	VCCO_4	AC19	VCCO
4	VCCO_4	VCCO_4	AC20	VCCO
4	VCCO_4	VCCO_4	AC21	VCCO
4	VCCO_4	VCCO_4	AC22	VCCO
4	VCCO_4	VCCO_4	AG20	VCCO
4	VCCO_4	VCCO_4	AG24	VCCO
4	VCCO_4	VCCO_4	AH27	VCCO
4	VCCO_4	VCCO_4	AJ22	VCCO
4	VCCO_4	VCCO_4	AL19	VCCO
4	VCCO_4	VCCO_4	AL24	VCCO
4	VCCO_4	VCCO_4	AM27	VCCO

**Table 37: FG1156 Package Pinout (Continued)**

Bank	XC3S4000 Pin Name	XC3S5000 Pin Name	FG1156 Pin Number	Type
4	VCCO_4	VCCO_4	AM31	VCCO
4	VCCO_4	VCCO_4	AN22	VCCO
5	IO	IO	AD11	I/O
5	N.C. (◆)	IO	AD12	I/O
5	IO	IO	AD14	I/O
5	IO	IO	AD15	I/O
5	IO	IO	AD16	I/O
5	IO	IO	AD17	I/O
5	IO	IO	AE14	I/O
5	IO	IO	AE16	I/O
5	N.C. (◆)	IO	AF9	I/O
5	IO	IO	AG9	I/O
5	IO	IO	AG12	I/O
5	IO	IO	AJ6	I/O
5	IO	IO	AJ17	I/O
5	IO	IO	AK10	I/O
5	IO	IO	AK14	I/O
5	IO	IO	AM12	I/O
5	IO	IO	AN9	I/O
5	IO/VREF_5	IO/VREF_5	AJ8	VREF
5	IO/VREF_5	IO/VREF_5	AL5	VREF
5	IO/VREF_5	IO/VREF_5	AP17	VREF
5	IO_L01N_5/ RDWR_B	IO_L01N_5/ RDWR_B	AP3	DUAL
5	IO_L01P_5/ CS_B	IO_L01P_5/ CS_B	AN3	DUAL
5	IO_L02N_5	IO_L02N_5	AP4	I/O
5	IO_L02P_5	IO_L02P_5	AN4	I/O
5	IO_L03N_5	IO_L03N_5	AN5	I/O
5	IO_L03P_5	IO_L03P_5	AM5	I/O
5	IO_L04N_5	IO_L04N_5	AM6	I/O
5	IO_L04P_5	IO_L04P_5	AL6	I/O
5	IO_L05N_5	IO_L05N_5	AP6	I/O
5	IO_L05P_5	IO_L05P_5	AN6	I/O
5	IO_L06N_5	IO_L06N_5	AK7	I/O
5	IO_L06P_5	IO_L06P_5	AJ7	I/O
5	IO_L07N_5	IO_L07N_5	AG10	I/O
5	IO_L07P_5	IO_L07P_5	AF10	I/O
5	IO_L08N_5	IO_L08N_5	AJ10	I/O
5	IO_L08P_5	IO_L08P_5	AH10	I/O
5	IO_L09N_5	IO_L09N_5	AM10	I/O
5	IO_L09P_5	IO_L09P_5	AL10	I/O

Table 37: FG1156 Package Pinout (Continued)

Bank	XC3S4000 Pin Name	XC3S5000 Pin Name	FG1156 Pin Number	Type
5	IO_L10N_5/ VRP_5	IO_L10N_5/ VRP_5	AP10	DCI
5	IO_L10P_5/ VRN_5	IO_L10P_5/ VRN_5	AN10	DCI
5	IO_L11N_5/ VREF_5	IO_L11N_5/ VREF_5	AP11	VREF
5	IO_L11P_5	IO_L11P_5	AN11	I/O
5	IO_L12N_5	IO_L12N_5	AF12	I/O
5	IO_L12P_5	IO_L12P_5	AE12	I/O
5	IO_L13N_5	IO_L13N_5	AJ12	I/O
5	IO_L13P_5	IO_L13P_5	AH12	I/O
5	IO_L14N_5	IO_L14N_5	AL12	I/O
5	IO_L14P_5	IO_L14P_5	AK12	I/O
5	IO_L15N_5	IO_L15N_5	AP12	I/O
5	IO_L15P_5	IO_L15P_5	AN12	I/O
5	IO_L16N_5	IO_L16N_5	AE13	I/O
5	IO_L16P_5	IO_L16P_5	AD13	I/O
5	IO_L17N_5	IO_L17N_5	AH13	I/O
5	IO_L17P_5	IO_L17P_5	AG13	I/O
5	IO_L18N_5	IO_L18N_5	AM13	I/O
5	IO_L18P_5	IO_L18P_5	AL13	I/O
5	IO_L19N_5	IO_L19N_5	AG14	I/O
5	IO_L19P_5/ VREF_5	IO_L19P_5/ VREF_5	AF14	VREF
5	IO_L20N_5	IO_L20N_5	AJ14	I/O
5	IO_L20P_5	IO_L20P_5	AH14	I/O
5	IO_L21N_5	IO_L21N_5	AM14	I/O
5	IO_L21P_5	IO_L21P_5	AL14	I/O
5	IO_L22N_5	IO_L22N_5	AP14	I/O
5	IO_L22P_5	IO_L22P_5	AN14	I/O
5	IO_L23N_5	IO_L23N_5	AF15	I/O
5	IO_L23P_5	IO_L23P_5	AE15	I/O
5	IO_L24N_5	IO_L24N_5	AJ15	I/O
5	IO_L24P_5	IO_L24P_5	AH15	I/O
5	IO_L25N_5	IO_L25N_5	AM15	I/O
5	IO_L25P_5	IO_L25P_5	AL15	I/O
5	IO_L26N_5	IO_L26N_5	AP15	I/O
5	IO_L26P_5	IO_L26P_5	AN15	I/O
5	IO_L27N_5/ VREF_5	IO_L27N_5/ VREF_5	AJ16	VREF
5	IO_L27P_5	IO_L27P_5	AH16	I/O
5	IO_L28N_5/ D6	IO_L28N_5/ D6	AN16	DUAL

Table 37: FG1156 Package Pinout (Continued)

Bank	XC3S4000 Pin Name	XC3S5000 Pin Name	FG1156 Pin Number	Type
5	IO_L28P_5/ D7	IO_L28P_5/ D7	AM16	DUAL
5	IO_L29N_5	IO_L29N_5	AF17	I/O
5	IO_L29P_5/ VREF_5	IO_L29P_5/ VREF_5	AE17	VREF
5	IO_L30N_5	IO_L30N_5	AH17	I/O
5	IO_L30P_5	IO_L30P_5	AG17	I/O
5	IO_L31N_5/ D4	IO_L31N_5/ D4	AL17	DUAL
5	IO_L31P_5/ D5	IO_L31P_5/ D5	AK17	DUAL
5	IO_L32N_5/ GCLK3	IO_L32N_5/ GCLK3	AN17	GCLK
5	IO_L32P_5/ GCLK2	IO_L32P_5/ GCLK2	AM17	GCLK
5	N.C. (◆)	IO_L33N_5	AM7	I/O
5	N.C. (◆)	IO_L33P_5	AL7	I/O
5	N.C. (◆)	IO_L34N_5	AP7	I/O
5	N.C. (◆)	IO_L34P_5	AN7	I/O
5	IO_L35N_5	IO_L35N_5	AL8	I/O
5	IO_L35P_5	IO_L35P_5	AK8	I/O
5	IO_L36N_5	IO_L36N_5	AP8	I/O
5	IO_L36P_5	IO_L36P_5	AN8	I/O
5	IO_L37N_5	IO_L37N_5	AJ9	I/O
5	IO_L37P_5	IO_L37P_5	AH9	I/O
5	IO_L38N_5	IO_L38N_5	AM9	I/O
5	IO_L38P_5	IO_L38P_5	AL9	I/O
5	N.C. (◆)	IO_L39N_5	AF11	I/O
5	N.C. (◆)	IO_L39P_5	AE11	I/O
5	N.C. (◆)	IO_L40N_5	AJ11	I/O
5	N.C. (◆)	IO_L40P_5	AH11	I/O
5	VCCO_5	VCCO_5	AC13	VCCO
5	VCCO_5	VCCO_5	AC14	VCCO
5	VCCO_5	VCCO_5	AC15	VCCO
5	VCCO_5	VCCO_5	AC16	VCCO
5	VCCO_5	VCCO_5	AG11	VCCO
5	VCCO_5	VCCO_5	AG15	VCCO
5	VCCO_5	VCCO_5	AH8	VCCO
5	VCCO_5	VCCO_5	AJ13	VCCO
5	VCCO_5	VCCO_5	AL11	VCCO
5	VCCO_5	VCCO_5	AL16	VCCO
5	VCCO_5	VCCO_5	AM4	VCCO
5	VCCO_5	VCCO_5	AM8	VCCO

**Table 37: FG1156 Package Pinout (Continued)**

Bank	XC3S4000 Pin Name	XC3S5000 Pin Name	FG1156 Pin Number	Type
5	VCCO_5	VCCO_5	AN13	VCCO
6	IO	IO	AH1	I/O
6	IO	IO	AH2	I/O
6	IO	IO	V9	I/O
6	IO	IO	V10	I/O
6	IO_L01N_6/ VRP_6	IO_L01N_6/ VRP_6	AM2	DCI
6	IO_L01P_6/ VRN_6	IO_L01P_6/ VRN_6	AM1	DCI
6	IO_L02N_6	IO_L02N_6	AL2	I/O
6	IO_L02P_6	IO_L02P_6	AL1	I/O
6	IO_L03N_6/ VREF_6	IO_L03N_6/ VREF_6	AK3	VREF
6	IO_L03P_6	IO_L03P_6	AK2	I/O
6	IO_L04N_6	IO_L04N_6	AJ4	I/O
6	IO_L04P_6	IO_L04P_6	AJ3	I/O
6	IO_L05N_6	IO_L05N_6	AJ2	I/O
6	IO_L05P_6	IO_L05P_6	AJ1	I/O
6	IO_L06N_6	IO_L06N_6	AH6	I/O
6	IO_L06P_6	IO_L06P_6	AH5	I/O
6	IO_L07N_6	IO_L07N_6	AG6	I/O
6	IO_L07P_6	IO_L07P_6	AG5	I/O
6	IO_L08N_6	IO_L08N_6	AG2	I/O
6	IO_L08P_6	IO_L08P_6	AG1	I/O
6	IO_L09N_6/ VREF_6	IO_L09N_6/ VREF_6	AF7	VREF
6	IO_L09P_6	IO_L09P_6	AF6	I/O
6	IO_L10N_6	IO_L10N_6	AG4	I/O
6	IO_L10P_6	IO_L10P_6	AF4	I/O
6	IO_L11N_6	IO_L11N_6	AF3	I/O
6	IO_L11P_6	IO_L11P_6	AF2	I/O
6	IO_L12N_6	IO_L12N_6	AF8	I/O
6	IO_L12P_6	IO_L12P_6	AE9	I/O
6	IO_L13N_6	IO_L13N_6	AE8	I/O
6	IO_L13P_6/ VREF_6	IO_L13P_6/ VREF_6	AE7	VREF
6	IO_L14N_6	IO_L14N_6	AE6	I/O
6	IO_L14P_6	IO_L14P_6	AE5	I/O
6	IO_L15N_6	IO_L15N_6	AE4	I/O
6	IO_L15P_6	IO_L15P_6	AE3	I/O
6	IO_L16N_6	IO_L16N_6	AE2	I/O
6	IO_L16P_6	IO_L16P_6	AE1	I/O

**Table 37: FG1156 Package Pinout (Continued)**

Bank	XC3S4000 Pin Name	XC3S5000 Pin Name	FG1156 Pin Number	Type
6	IO_L17N_6	IO_L17N_6	AD10	I/O
6	IO_L17P_6/ VREF_6	IO_L17P_6/ VREF_6	AD9	VREF
6	IO_L19N_6	IO_L19N_6	AD2	I/O
6	IO_L19P_6	IO_L19P_6	AD1	I/O
6	IO_L20N_6	IO_L20N_6	AC11	I/O
6	IO_L20P_6	IO_L20P_6	AC10	I/O
6	IO_L21N_6	IO_L21N_6	AC8	I/O
6	IO_L21P_6	IO_L21P_6	AC7	I/O
6	IO_L22N_6	IO_L22N_6	AC6	I/O
6	IO_L22P_6	IO_L22P_6	AC5	I/O
6	IO_L23N_6	IO_L23N_6	AC2	I/O
6	IO_L23P_6	IO_L23P_6	AC1	I/O
6	IO_L24N_6/ VREF_6	IO_L24N_6/ VREF_6	AC9	VREF
6	IO_L24P_6	IO_L24P_6	AB10	I/O
6	IO_L25N_6	IO_L25N_6	AB8	I/O
6	IO_L25P_6	IO_L25P_6	AB7	I/O
6	IO_L26N_6	IO_L26N_6	AB4	I/O
6	IO_L26P_6	IO_L26P_6	AB3	I/O
6	IO_L27N_6	IO_L27N_6	AB11	I/O
6	IO_L27P_6	IO_L27P_6	AA11	I/O
6	IO_L28N_6	IO_L28N_6	AA8	I/O
6	IO_L28P_6	IO_L28P_6	AA7	I/O
6	IO_L29N_6	IO_L29N_6	AA6	I/O
6	IO_L29P_6	IO_L29P_6	AA5	I/O
6	IO_L30N_6	IO_L30N_6	AA4	I/O
6	IO_L30P_6	IO_L30P_6	AA3	I/O
6	IO_L31N_6	IO_L31N_6	AA2	I/O
6	IO_L31P_6	IO_L31P_6	AA1	I/O
6	IO_L32N_6	IO_L32N_6	Y11	I/O
6	IO_L32P_6	IO_L32P_6	Y10	I/O
6	IO_L33N_6	IO_L33N_6	Y4	I/O
6	IO_L33P_6	IO_L33P_6	Y3	I/O
6	IO_L34N_6/ VREF_6	IO_L34N_6/ VREF_6	Y2	VREF
6	IO_L34P_6	IO_L34P_6	Y1	I/O
6	IO_L35N_6	IO_L35N_6	Y9	I/O
6	IO_L35P_6	IO_L35P_6	W10	I/O
6	IO_L36N_6	IO_L36N_6	W7	I/O
6	IO_L36P_6	IO_L36P_6	W6	I/O
6	IO_L37N_6	IO_L37N_6	W3	I/O

Table 37: FG1156 Package Pinout (Continued)

Bank	XC3S4000 Pin Name	XC3S5000 Pin Name	FG1156 Pin Number	Type
6	IO_L37P_6	IO_L37P_6	W2	I/O
6	IO_L38N_6	IO_L38N_6	V6	I/O
6	IO_L38P_6	IO_L38P_6	V5	I/O
6	IO_L39N_6	IO_L39N_6	V4	I/O
6	IO_L39P_6	IO_L39P_6	V3	I/O
6	IO_L40N_6	IO_L40N_6	V2	I/O
6	IO_L40P_6/ VREF_6	IO_L40P_6/ VREF_6	V1	VREF
6	N.C. (◆)	IO_L41N_6	AH4	I/O
6	N.C. (◆)	IO_L41P_6	AH3	I/O
6	N.C. (◆)	IO_L44N_6	AD7	I/O
6	N.C. (◆)	IO_L44P_6	AD6	I/O
6	IO_L45N_6	IO_L45N_6	AC4	I/O
6	IO_L45P_6	IO_L45P_6	AC3	I/O
6	N.C. (◆)	IO_L46N_6	AA10	I/O
6	N.C. (◆)	IO_L46P_6	AA9	I/O
6	IO_L48N_6	IO_L48N_6	Y7	I/O
6	IO_L48P_6	IO_L48P_6	Y6	I/O
6	N.C. (◆)	IO_L49N_6	W11	I/O
6	N.C. (◆)	IO_L49P_6	V11	I/O
6	IO_L52N_6	IO_L52N_6	V8	I/O
6	IO_L52P_6	IO_L52P_6	V7	I/O
6	VCCO_6	VCCO_6	AA12	VCCO
6	VCCO_6	VCCO_6	AB12	VCCO
6	VCCO_6	VCCO_6	AB2	VCCO
6	VCCO_6	VCCO_6	AB6	VCCO
6	VCCO_6	VCCO_6	AD4	VCCO
6	VCCO_6	VCCO_6	AD8	VCCO
6	VCCO_6	VCCO_6	AG3	VCCO
6	VCCO_6	VCCO_6	AG7	VCCO
6	VCCO_6	VCCO_6	AL3	VCCO
6	VCCO_6	VCCO_6	W12	VCCO
6	VCCO_6	VCCO_6	W4	VCCO
6	VCCO_6	VCCO_6	Y12	VCCO
6	VCCO_6	VCCO_6	Y8	VCCO
7	IO	IO	G1	I/O
7	IO	IO	G2	I/O
7	IO	IO	U10	I/O
7	IO	IO	U9	I/O
7	IO_L01N_7/ VRP_7	IO_L01N_7/ VRP_7	C1	DCI

Table 37: FG1156 Package Pinout (Continued)

Bank	XC3S4000 Pin Name	XC3S5000 Pin Name	FG1156 Pin Number	Type
7	IO_L01P_7/ VRN_7	IO_L01P_7/ VRN_7	C2	DCI
7	IO_L02N_7	IO_L02N_7	D1	I/O
7	IO_L02P_7	IO_L02P_7	D2	I/O
7	IO_L03N_7/ VREF_7	IO_L03N_7/ VREF_7	E2	VREF
7	IO_L03P_7	IO_L03P_7	E3	I/O
7	IO_L04N_7	IO_L04N_7	F3	I/O
7	IO_L04P_7	IO_L04P_7	F4	I/O
7	IO_L05N_7	IO_L05N_7	F1	I/O
7	IO_L05P_7	IO_L05P_7	F2	I/O
7	IO_L06N_7	IO_L06N_7	G5	I/O
7	IO_L06P_7	IO_L06P_7	G6	I/O
7	IO_L07N_7	IO_L07N_7	H5	I/O
7	IO_L07P_7	IO_L07P_7	H6	I/O
7	IO_L08N_7	IO_L08N_7	H1	I/O
7	IO_L08P_7	IO_L08P_7	H2	I/O
7	IO_L09N_7	IO_L09N_7	J6	I/O
7	IO_L09P_7	IO_L09P_7	J7	I/O
7	IO_L10N_7	IO_L10N_7	J4	I/O
7	IO_L10P_7/ VREF_7	IO_L10P_7/ VREF_7	H4	VREF
7	IO_L11N_7	IO_L11N_7	J2	I/O
7	IO_L11P_7	IO_L11P_7	J3	I/O
7	IO_L12N_7	IO_L12N_7	K9	I/O
7	IO_L12P_7	IO_L12P_7	J8	I/O
7	IO_L13N_7	IO_L13N_7	K7	I/O
7	IO_L13P_7	IO_L13P_7	K8	I/O
7	IO_L14N_7	IO_L14N_7	K5	I/O
7	IO_L14P_7	IO_L14P_7	K6	I/O
7	IO_L15N_7	IO_L15N_7	K3	I/O
7	IO_L15P_7	IO_L15P_7	K4	I/O
7	IO_L16N_7	IO_L16N_7	K1	I/O
7	IO_L16P_7/ VREF_7	IO_L16P_7/ VREF_7	K2	VREF
7	IO_L17N_7	IO_L17N_7	L9	I/O
7	IO_L17P_7	IO_L17P_7	L10	I/O
7	IO_L19N_7/ VREF_7	IO_L19N_7/ VREF_7	L1	VREF
7	IO_L19P_7	IO_L19P_7	L2	I/O
7	IO_L20N_7	IO_L20N_7	M10	I/O
7	IO_L20P_7	IO_L20P_7	M11	I/O

**Table 37: FG1156 Package Pinout (Continued)**

Bank	XC3S4000 Pin Name	XC3S5000 Pin Name	FG1156 Pin Number	Type
7	IO_L21N_7	IO_L21N_7	M7	I/O
7	IO_L21P_7	IO_L21P_7	M8	I/O
7	IO_L22N_7	IO_L22N_7	M5	I/O
7	IO_L22P_7	IO_L22P_7	M6	I/O
7	IO_L23N_7	IO_L23N_7	M3	I/O
7	IO_L23P_7	IO_L23P_7	M4	I/O
7	IO_L24N_7	IO_L24N_7	N10	I/O
7	IO_L24P_7	IO_L24P_7	M9	I/O
7	IO_L25N_7	IO_L25N_7	N3	I/O
7	IO_L25P_7	IO_L25P_7	N4	I/O
7	IO_L26N_7	IO_L26N_7	P11	I/O
7	IO_L26P_7	IO_L26P_7	N11	I/O
7	IO_L27N_7	IO_L27N_7	P7	I/O
7	IO_L27P_7/ VREF_7	IO_L27P_7/ VREF_7	P8	VREF
7	IO_L28N_7	IO_L28N_7	P5	I/O
7	IO_L28P_7	IO_L28P_7	P6	I/O
7	IO_L29N_7	IO_L29N_7	P3	I/O
7	IO_L29P_7	IO_L29P_7	P4	I/O
7	IO_L30N_7	IO_L30N_7	R6	I/O
7	IO_L30P_7	IO_L30P_7	R7	I/O
7	IO_L31N_7	IO_L31N_7	R3	I/O
7	IO_L31P_7	IO_L31P_7	R4	I/O
7	IO_L32N_7	IO_L32N_7	R1	I/O
7	IO_L32P_7	IO_L32P_7	R2	I/O
7	IO_L33N_7	IO_L33N_7	T10	I/O
7	IO_L33P_7	IO_L33P_7	R9	I/O
7	IO_L34N_7	IO_L34N_7	T6	I/O
7	IO_L34P_7	IO_L34P_7	T7	I/O
7	IO_L35N_7	IO_L35N_7	T2	I/O
7	IO_L35P_7	IO_L35P_7	T3	I/O
7	IO_L37N_7	IO_L37N_7	U7	I/O
7	IO_L37P_7/ VREF_7	IO_L37P_7/ VREF_7	U8	VREF
7	IO_L38N_7	IO_L38N_7	U5	I/O
7	IO_L38P_7	IO_L38P_7	U6	I/O
7	IO_L39N_7	IO_L39N_7	U3	I/O
7	IO_L39P_7	IO_L39P_7	U4	I/O
7	IO_L40N_7/ VREF_7	IO_L40N_7/ VREF_7	U1	VREF
7	IO_L40P_7	IO_L40P_7	U2	I/O
7	N.C. (◆)	IO_L41N_7	G3	I/O

**Table 37: FG1156 Package Pinout (Continued)**

Bank	XC3S4000 Pin Name	XC3S5000 Pin Name	FG1156 Pin Number	Type
7	N.C. (◆)	IO_L41P_7	G4	I/O
7	N.C. (◆)	IO_L44N_7	L6	I/O
7	N.C. (◆)	IO_L44P_7	L7	I/O
7	IO_L45N_7	IO_L45N_7	M1	I/O
7	IO_L45P_7	IO_L45P_7	M2	I/O
7	IO_L46N_7	IO_L46N_7	N7	I/O
7	IO_L46P_7	IO_L46P_7	N8	I/O
7	N.C. (◆)	IO_L47N_7	P9	I/O
7	N.C. (◆)	IO_L47P_7	P10	I/O
7	IO_L49N_7	IO_L49N_7	P1	I/O
7	IO_L49P_7	IO_L49P_7	P2	I/O
7	IO_L50N_7	IO_L50N_7	R10	I/O
7	IO_L50P_7	IO_L50P_7	R11	I/O
7	N.C. (◆)	IO_L51N_7	U11	I/O
7	N.C. (◆)	IO_L51P_7	T11	I/O
7	VCCO_7	VCCO_7	D3	VCCO
7	VCCO_7	VCCO_7	H3	VCCO
7	VCCO_7	VCCO_7	H7	VCCO
7	VCCO_7	VCCO_7	L4	VCCO
7	VCCO_7	VCCO_7	L8	VCCO
7	VCCO_7	VCCO_7	N12	VCCO
7	VCCO_7	VCCO_7	N2	VCCO
7	VCCO_7	VCCO_7	N6	VCCO
7	VCCO_7	VCCO_7	P12	VCCO
7	VCCO_7	VCCO_7	R12	VCCO
7	VCCO_7	VCCO_7	R8	VCCO
7	VCCO_7	VCCO_7	T12	VCCO
7	VCCO_7	VCCO_7	T4	VCCO
N/A	GND	GND	A1	GND
N/A	GND	GND	A13	GND
N/A	GND	GND	A16	GND
N/A	GND	GND	A19	GND
N/A	GND	GND	A2	GND
N/A	GND	GND	A22	GND
N/A	GND	GND	A26	GND
N/A	GND	GND	A30	GND
N/A	GND	GND	A33	GND
N/A	GND	GND	A34	GND
N/A	GND	GND	A5	GND
N/A	GND	GND	A9	GND
N/A	GND	GND	AA14	GND

Table 37: FG1156 Package Pinout (Continued)

Bank	XC3S4000 Pin Name	XC3S5000 Pin Name	FG1156 Pin Number	Type
N/A	GND	GND	AA15	GND
N/A	GND	GND	AA16	GND
N/A	GND	GND	AA17	GND
N/A	GND	GND	AA18	GND
N/A	GND	GND	AA19	GND
N/A	GND	GND	AA20	GND
N/A	GND	GND	AA21	GND
N/A	GND	GND	AB1	GND
N/A	GND	GND	AB17	GND
N/A	GND	GND	AB18	GND
N/A	GND	GND	AB26	GND
N/A	GND	GND	AB30	GND
N/A	GND	GND	AB34	GND
N/A	GND	GND	AB5	GND
N/A	GND	GND	AB9	GND
N/A	GND	GND	AD3	GND
N/A	GND	GND	AD32	GND
N/A	GND	GND	AE10	GND
N/A	GND	GND	AE25	GND
N/A	GND	GND	AF1	GND
N/A	GND	GND	AF13	GND
N/A	GND	GND	AF16	GND
N/A	GND	GND	AF19	GND
N/A	GND	GND	AF22	GND
N/A	GND	GND	AF30	GND
N/A	GND	GND	AF34	GND
N/A	GND	GND	AF5	GND
N/A	GND	GND	AH28	GND
N/A	GND	GND	AH7	GND
N/A	GND	GND	AK1	GND
N/A	GND	GND	AK13	GND
N/A	GND	GND	AK16	GND
N/A	GND	GND	AK19	GND
N/A	GND	GND	AK22	GND
N/A	GND	GND	AK26	GND
N/A	GND	GND	AK30	GND
N/A	GND	GND	AK34	GND
N/A	GND	GND	AK5	GND
N/A	GND	GND	AK9	GND
N/A	GND	GND	AM11	GND
N/A	GND	GND	AM24	GND

Table 37: FG1156 Package Pinout (Continued)

Bank	XC3S4000 Pin Name	XC3S5000 Pin Name	FG1156 Pin Number	Type
N/A	GND	GND	AM3	GND
N/A	GND	GND	AM32	GND
N/A	GND	GND	AN1	GND
N/A	GND	GND	AN2	GND
N/A	GND	GND	AN33	GND
N/A	GND	GND	AN34	GND
N/A	GND	GND	AP1	GND
N/A	GND	GND	AP13	GND
N/A	GND	GND	AP16	GND
N/A	GND	GND	AP19	GND
N/A	GND	GND	AP2	GND
N/A	GND	GND	AP22	GND
N/A	GND	GND	AP26	GND
N/A	GND	GND	AP30	GND
N/A	GND	GND	AP33	GND
N/A	GND	GND	AP34	GND
N/A	GND	GND	AP5	GND
N/A	GND	GND	AP9	GND
N/A	GND	GND	B1	GND
N/A	GND	GND	B2	GND
N/A	GND	GND	B33	GND
N/A	GND	GND	B34	GND
N/A	GND	GND	C11	GND
N/A	GND	GND	C24	GND
N/A	GND	GND	C3	GND
N/A	GND	GND	C32	GND
N/A	GND	GND	E1	GND
N/A	GND	GND	E13	GND
N/A	GND	GND	E16	GND
N/A	GND	GND	E19	GND
N/A	GND	GND	E22	GND
N/A	GND	GND	E26	GND
N/A	GND	GND	E30	GND
N/A	GND	GND	E34	GND
N/A	GND	GND	E5	GND
N/A	GND	GND	E9	GND
N/A	GND	GND	G28	GND
N/A	GND	GND	G7	GND
N/A	GND	GND	J1	GND
N/A	GND	GND	J13	GND
N/A	GND	GND	J16	GND



Table 37: FG1156 Package Pinout (Continued)

Bank	XC3S4000 Pin Name	XC3S5000 Pin Name	FG1156 Pin Number	Type
N/A	GND	GND	J19	GND
N/A	GND	GND	J22	GND
N/A	GND	GND	J30	GND
N/A	GND	GND	J34	GND
N/A	GND	GND	J5	GND
N/A	GND	GND	K10	GND
N/A	GND	GND	K25	GND
N/A	GND	GND	L3	GND
N/A	GND	GND	L32	GND
N/A	GND	GND	N1	GND
N/A	GND	GND	N17	GND
N/A	GND	GND	N18	GND
N/A	GND	GND	N26	GND
N/A	GND	GND	N30	GND
N/A	GND	GND	N34	GND
N/A	GND	GND	N5	GND
N/A	GND	GND	N9	GND
N/A	GND	GND	P14	GND
N/A	GND	GND	P15	GND
N/A	GND	GND	P16	GND
N/A	GND	GND	P17	GND
N/A	GND	GND	P18	GND
N/A	GND	GND	P19	GND
N/A	GND	GND	P20	GND
N/A	GND	GND	P21	GND
N/A	GND	GND	R14	GND
N/A	GND	GND	R15	GND
N/A	GND	GND	R16	GND
N/A	GND	GND	R17	GND
N/A	GND	GND	R18	GND
N/A	GND	GND	R19	GND
N/A	GND	GND	R20	GND
N/A	GND	GND	R21	GND
N/A	GND	GND	T1	GND
N/A	GND	GND	T14	GND
N/A	GND	GND	T15	GND
N/A	GND	GND	T16	GND
N/A	GND	GND	T17	GND
N/A	GND	GND	T18	GND
N/A	GND	GND	T19	GND
N/A	GND	GND	T20	GND

Table 37: FG1156 Package Pinout (Continued)

Bank	XC3S4000 Pin Name	XC3S5000 Pin Name	FG1156 Pin Number	Type
N/A	GND	GND	T21	GND
N/A	GND	GND	T26	GND
N/A	GND	GND	T30	GND
N/A	GND	GND	T34	GND
N/A	GND	GND	T5	GND
N/A	GND	GND	T9	GND
N/A	GND	GND	U13	GND
N/A	GND	GND	U14	GND
N/A	GND	GND	U15	GND
N/A	GND	GND	U16	GND
N/A	GND	GND	U17	GND
N/A	GND	GND	U18	GND
N/A	GND	GND	U19	GND
N/A	GND	GND	U20	GND
N/A	GND	GND	U21	GND
N/A	GND	GND	U22	GND
N/A	GND	GND	V13	GND
N/A	GND	GND	V14	GND
N/A	GND	GND	V15	GND
N/A	GND	GND	V16	GND
N/A	GND	GND	V17	GND
N/A	GND	GND	V18	GND
N/A	GND	GND	V19	GND
N/A	GND	GND	V20	GND
N/A	GND	GND	V21	GND
N/A	GND	GND	V22	GND
N/A	GND	GND	W1	GND
N/A	GND	GND	W14	GND
N/A	GND	GND	W15	GND
N/A	GND	GND	W16	GND
N/A	GND	GND	W17	GND
N/A	GND	GND	W18	GND
N/A	GND	GND	W19	GND
N/A	GND	GND	W20	GND
N/A	GND	GND	W21	GND
N/A	GND	GND	W26	GND
N/A	GND	GND	W30	GND
N/A	GND	GND	W34	GND
N/A	GND	GND	W5	GND
N/A	GND	GND	W9	GND
N/A	GND	GND	Y14	GND

Table 37: FG1156 Package Pinout (Continued)

Bank	XC3S4000 Pin Name	XC3S5000 Pin Name	FG1156 Pin Number	Type
N/A	GND	GND	Y15	GND
N/A	GND	GND	Y16	GND
N/A	GND	GND	Y17	GND
N/A	GND	GND	Y18	GND
N/A	GND	GND	Y19	GND
N/A	GND	GND	Y20	GND
N/A	GND	GND	Y21	GND
N/A	N.C. (◆)	N.C. (■)	AK31	N.C.
N/A	VCCAUX	VCCAUX	AD30	VCCAUX
N/A	VCCAUX	VCCAUX	AD5	VCCAUX
N/A	VCCAUX	VCCAUX	AG16	VCCAUX
N/A	VCCAUX	VCCAUX	AG19	VCCAUX
N/A	VCCAUX	VCCAUX	AJ30	VCCAUX
N/A	VCCAUX	VCCAUX	AJ5	VCCAUX
N/A	VCCAUX	VCCAUX	AK11	VCCAUX
N/A	VCCAUX	VCCAUX	AK15	VCCAUX
N/A	VCCAUX	VCCAUX	AK20	VCCAUX
N/A	VCCAUX	VCCAUX	AK24	VCCAUX
N/A	VCCAUX	VCCAUX	AK29	VCCAUX
N/A	VCCAUX	VCCAUX	AK6	VCCAUX
N/A	VCCAUX	VCCAUX	E11	VCCAUX
N/A	VCCAUX	VCCAUX	E15	VCCAUX
N/A	VCCAUX	VCCAUX	E20	VCCAUX
N/A	VCCAUX	VCCAUX	E24	VCCAUX
N/A	VCCAUX	VCCAUX	E29	VCCAUX
N/A	VCCAUX	VCCAUX	E6	VCCAUX
N/A	VCCAUX	VCCAUX	F30	VCCAUX
N/A	VCCAUX	VCCAUX	F5	VCCAUX
N/A	VCCAUX	VCCAUX	H16	VCCAUX
N/A	VCCAUX	VCCAUX	H19	VCCAUX
N/A	VCCAUX	VCCAUX	L30	VCCAUX
N/A	VCCAUX	VCCAUX	L5	VCCAUX
N/A	VCCAUX	VCCAUX	R30	VCCAUX
N/A	VCCAUX	VCCAUX	R5	VCCAUX
N/A	VCCAUX	VCCAUX	T27	VCCAUX
N/A	VCCAUX	VCCAUX	T8	VCCAUX
N/A	VCCAUX	VCCAUX	W27	VCCAUX
N/A	VCCAUX	VCCAUX	W8	VCCAUX
N/A	VCCAUX	VCCAUX	Y30	VCCAUX
N/A	VCCAUX	VCCAUX	Y5	VCCAUX
N/A	VCCINT	VCCINT	AA13	VCCINT

Table 37: FG1156 Package Pinout (Continued)

Bank	XC3S4000 Pin Name	XC3S5000 Pin Name	FG1156 Pin Number	Type
N/A	VCCINT	VCCINT	AA22	VCCINT
N/A	VCCINT	VCCINT	AB13	VCCINT
N/A	VCCINT	VCCINT	AB14	VCCINT
N/A	VCCINT	VCCINT	AB15	VCCINT
N/A	VCCINT	VCCINT	AB16	VCCINT
N/A	VCCINT	VCCINT	AB19	VCCINT
N/A	VCCINT	VCCINT	AB20	VCCINT
N/A	VCCINT	VCCINT	AB21	VCCINT
N/A	VCCINT	VCCINT	AB22	VCCINT
N/A	VCCINT	VCCINT	AC12	VCCINT
N/A	VCCINT	VCCINT	AC17	VCCINT
N/A	VCCINT	VCCINT	AC18	VCCINT
N/A	VCCINT	VCCINT	AC23	VCCINT
N/A	VCCINT	VCCINT	M12	VCCINT
N/A	VCCINT	VCCINT	M17	VCCINT
N/A	VCCINT	VCCINT	M18	VCCINT
N/A	VCCINT	VCCINT	M23	VCCINT
N/A	VCCINT	VCCINT	N13	VCCINT
N/A	VCCINT	VCCINT	N14	VCCINT
N/A	VCCINT	VCCINT	N15	VCCINT
N/A	VCCINT	VCCINT	N16	VCCINT
N/A	VCCINT	VCCINT	N19	VCCINT
N/A	VCCINT	VCCINT	N20	VCCINT
N/A	VCCINT	VCCINT	N21	VCCINT
N/A	VCCINT	VCCINT	N22	VCCINT
N/A	VCCINT	VCCINT	P13	VCCINT
N/A	VCCINT	VCCINT	P22	VCCINT
N/A	VCCINT	VCCINT	R13	VCCINT
N/A	VCCINT	VCCINT	R22	VCCINT
N/A	VCCINT	VCCINT	T13	VCCINT
N/A	VCCINT	VCCINT	T22	VCCINT
N/A	VCCINT	VCCINT	U12	VCCINT
N/A	VCCINT	VCCINT	U23	VCCINT
N/A	VCCINT	VCCINT	V12	VCCINT
N/A	VCCINT	VCCINT	V23	VCCINT
N/A	VCCINT	VCCINT	W13	VCCINT
N/A	VCCINT	VCCINT	W22	VCCINT
N/A	VCCINT	VCCINT	Y13	VCCINT
N/A	VCCINT	VCCINT	Y22	VCCINT
VCCAUX	CCLK	CCLK	AL31	CONFIG
VCCAUX	DONE	DONE	AD24	CONFIG

Table 37: FG1156 Package Pinout (Continued)

Bank	XC3S4000 Pin Name	XC3S5000 Pin Name	FG1156 Pin Number	Type
VCCAUX	HSWAP_EN	HSWAP_EN	L11	CONFIG
VCCAUX	M0	M0	AL4	CONFIG
VCCAUX	M1	M1	AK4	CONFIG
VCCAUX	M2	M2	AG8	CONFIG
VCCAUX	PROG_B	PROG_B	D4	CONFIG
VCCAUX	TCK	TCK	D31	JTAG
VCCAUX	TDI	TDI	E4	JTAG
VCCAUX	TDO	TDO	E31	JTAG
VCCAUX	TMS	TMS	H27	JTAG

### User I/Os by Bank

Table 38 indicates how the available user-I/O pins are distributed between the eight I/O banks for the XC3S4000 in the FG1156 package. Similarly, Table 39 shows how the available user-I/O pins are distributed between the eight I/O banks for the XC3S5000 in the FG1156 package.

Table 38: User I/Os Per Bank for XC3S4000 in FG1156 Package

Package Edge	I/O Bank	Maximum I/O	All Possible I/O Pins by Type				
			I/O	DUAL	DCI	VREF	GCLK
Top	0	90	79	0	2	7	2
	1	90	79	0	2	7	2
Right	2	88	80	0	2	6	0
	3	88	79	0	2	7	0
Bottom	4	90	73	6	2	7	2
	5	90	73	6	2	7	2
Left	6	88	79	0	2	7	0
	7	88	79	0	2	7	0

Table 39: User I/Os Per Bank for XC3S5000 in FG1156 Package

Package Edge	I/O Bank	Maximum I/O	All Possible I/O Pins by Type				
			I/O	DUAL	DCI	VREF	GCLK
Top	0	100	89	0	2	7	2
	1	100	89	0	2	7	2
Right	2	96	87	0	2	7	0
	3	96	87	0	2	7	0
Bottom	4	100	83	6	2	7	2
	5	100	83	6	2	7	2
Left	6	96	87	0	2	7	0
	7	96	87	0	2	7	0

## FG1156 Footprint

### Top Left Corner of Package (top view)

**XC3S4000**

(712 max. user I/O)

621 I/O: Unrestricted, general-purpose user I/O

55 VREF: User I/O or input voltage reference for bank

73 N.C.: Unconnected pins for XC3S4000 (◆)

**XC3S5000**

(784 max. user I/O)

692 I/O: Unrestricted, general-purpose user I/O

56 VREF: User I/O or input voltage reference for bank

1 N.C.: Unconnected pins for XC3S5000 (■)

Figure 16: FG1156 Package Footprint (top view)

		Bank 0																	
		1	2	3	4	5	6	7	8	9	10	11	12	13	14	15	16	17	
Bank 7	A	GND	GND	I/O L01P_0 VRN_0	I/O L02P_0	GND	I/O L05P_0 VREF_0	I/O L34P_0 ◆	I/O L36P_0	GND	I/O L38P_0	I/O L40P_0 ◆	I/O L15P_0	GND	I/O L22P_0	I/O L26P_0 VREF_0	GND	I/O L32P_0 GCLK6	
	B	GND	GND	I/O L01N_0 VRP_0	I/O L02N_0	I/O L03P_0	I/O L05N_0	I/O L34N_0 ◆	I/O L36N_0	I/O	I/O L38N_0	I/O L40N_0 ◆	I/O L15N_0	VCCO_0	I/O L22N_0	I/O L26N_0	I/O L28P_0	I/O L32N_0 GCLK7	
	C	I/O L01N_7 VRP_7	I/O L01P_7 VRN_7	GND	VCCO_0	I/O L03N_0	I/O L04P_0	I/O L33P_0 ◆	VCCO_0	I/O L08P_0	I/O L37P_0	GND	I/O L14P_0	I/O L17P_0	I/O L21P_0	I/O L25P_0	I/O L28N_0	I/O L31P_0 VREF_0	
	D	I/O L02N_7	I/O L02P_7	VCCO_7	PROG_B	I/O VREF_0	I/O L04N_0	I/O L33N_0 ◆	I/O L35P_0	I/O L08N_0	I/O L37N_0	VCCO_0	I/O L14N_0	I/O L17N_0	I/O L21N_0	I/O L25N_0	VCCO_0	I/O L31N_0	
	E	GND	I/O L03N_7 VREF_7	I/O L03P_7	TDI	GND	VCCAUX	I/O L06P_0	I/O L35N_0	GND	I/O VREF_0	VCCAUX	I/O L13P_0	GND	I/O L20P_0	VCCAUX	GND	I/O	
	F	I/O L05N_7	I/O L05P_7	I/O L04N_7	I/O L04P_7	VCCAUX	I/O	I/O L06N_0	I/O	I/O L07P_0	I/O L10P_0	I/O L39P_0 ◆	I/O L13N_0	VCCO_0	I/O L20N_0	I/O L24P_0	I/O L27P_0	I/O L30P_0	
	G	I/O	I/O	I/O L41N_7 ◆	I/O L41P_7 ◆	I/O L06N_7	I/O L06P_7	GND	VCCO_0	I/O L07N_0	I/O L10N_0	I/O L39N_0 ◆	I/O	I/O L16P_0	I/O L19P_0	I/O L24N_0	I/O L27N_0	I/O L30N_0	
	H	I/O L08N_7	I/O L08P_7	VCCO_7	I/O L10P_7 VREF_7	I/O L07N_7	I/O L07P_7	VCCO_7	I/O	I/O	I/O L09P_0	VCCO_0	I/O L12P_0	I/O L16N_0	I/O L19N_0	VCCO_0	VCCAUX	I/O L29P_0	
	J	GND	I/O L11N_7	I/O L11P_7	I/O L10N_7	GND	I/O L09N_7	I/O L09P_7	I/O L12P_7	I/O ◆	I/O L09N_0	I/O	I/O L12N_0	GND	I/O VREF_0	I/O L23P_0	GND	I/O L29N_0	
	K	I/O L16N_7	I/O L16P_7 VREF_7	I/O L15N_7	I/O L15P_7	I/O L14N_7	I/O L14P_7	I/O L13N_7	I/O L13P_7	I/O L12N_7	GND	I/O ◆	I/O L11P_0	I/O	I/O L18P_0	I/O L23N_0	I/O	I/O	
	L	I/O L19N_7 VREF_7	I/O L19P_7	GND	VCCO_7	VCCAUX	I/O L44N_7 ◆	I/O L44P_7 ◆	VCCO_7	I/O L17N_7	I/O L17P_7	HSWAP_EN	I/O L11N_0	I/O	I/O L18N_0	I/O VREF_0	I/O	I/O	
	M	I/O L45N_7	I/O L45P_7	I/O L23N_7	I/O L23P_7	I/O L22N_7	I/O L22P_7	I/O L21N_7	I/O L21P_7	I/O L24P_7	I/O L20N_7	I/O L20P_7	VCCINT	VCCO_0	VCCO_0	VCCO_0	VCCO_0	VCCINT	
	N	GND	VCCO_7	I/O L25N_7	I/O L25P_7	GND	VCCO_7	I/O L46N_7	I/O L46P_7	GND	I/O L24N_7	I/O L26P_7	VCCO_7	VCCINT	VCCINT	VCCINT	VCCINT	VCCINT	GND
	P	I/O L49N_7	I/O L49P_7	I/O L29N_7	I/O L29P_7	I/O L28N_7	I/O L28P_7	I/O L27N_7	I/O L27P_7 VREF_7	I/O L47N_7 ◆	I/O L47P_7 ◆	I/O L26N_7	VCCO_7	VCCINT	GND	GND	GND	GND	
	R	I/O L32N_7	I/O L32P_7	I/O L31N_7	I/O L31P_7	VCCAUX	I/O L30N_7	I/O L30P_7	VCCO_7	I/O L33P_7	I/O L50N_7	I/O L50P_7	VCCO_7	VCCINT	GND	GND	GND	GND	
	T	GND	I/O L35N_7	I/O L35P_7	VCCO_7	GND	I/O L34N_7	I/O L34P_7	VCCAUX	GND	I/O L33N_7	I/O L51P_7 ◆	VCCO_7	VCCINT	GND	GND	GND	GND	
U	I/O L40N_7 VREF_7	I/O L40P_7	I/O L39N_7	I/O L39P_7	I/O L38N_7	I/O L38P_7	I/O L37N_7	I/O L37P_7 VREF_7	I/O	I/O	I/O L51N_7 ◆	VCCINT	GND	GND	GND	GND	GND		

DS099-4\_14a\_072903

All Devices

Top Right Corner of Package (top view)

- 12 **DUAL:** Configuration pin, then possible user I/O
- 16 **DCI:** User I/O or reference resistor input for bank
- 8 **GCLK:** User I/O or global clock buffer input
- 7 **CONFIG:** Dedicated configuration pins
- 4 **JTAG:** Dedicated JTAG port pins
- 104 **VCCO:** Output voltage supply for bank
- 40 **VCCINT:** Internal core voltage supply (+1.2V)
- 32 **VCCAUX:** Auxiliary voltage supply (+2.5V)
- 184 **GND:** Ground

		Bank 1																		
		18	19	20	21	22	23	24	25	26	27	28	29	30	31	32	33	34		
	I/O	GND	I/O L40N_1	I/O L26N_1	GND	I/O L19N_1	I/O L15N_1	I/O L14N_1	GND	I/O L08N_1	I/O L34N_1 ◆	I/O L05N_1	GND	I/O L02N_1	I/O L01N_1 VRP_1	GND	GND	A		
	I/O L32N_1 GCLK5	I/O L28N_1	I/O L40P_1	I/O L26P_1	VCCO_1	I/O L19P_1	I/O L15P_1	I/O L14P_1	I/O	I/O L08P_1	I/O L34P_1 ◆	I/O L05P_1	I/O L03N_1	I/O L02P_1	I/O L01P_1 VRN_1	GND	GND	B		
	I/O L32P_1 GCLK4	I/O L28P_1	I/O L39N_1	I/O L25N_1	I/O L22N_1	I/O	GND	I/O L13N_1	I/O L10N_1 VREF_1	VCCO_1	I/O L33N_1 ◆	I/O L04N_1	I/O L03P_1	VCCO_1	GND	I/O L01N_2 VRP_2	I/O L01P_2 VRN_2	C		
	I/O L31N_1 VREF_1	VCCO_1	I/O L39P_1	I/O L25P_1	I/O L22P_1	I/O L18N_1	VCCO_1	I/O L13P_1	I/O L10P_1	I/O L07N_1	I/O L33P_1 ◆	I/O L04P_1	I/O VREF_1	TCK	VCCO_2	I/O L02N_2	I/O L02P_2	D		
	I/O L31P_1	GND	VCCAUX	I/O	GND	I/O L18P_1	VCCAUX	I/O	GND	I/O L07P_1	I/O L06N_1 VREF_1	VCCAUX	GND	TDO	I/O L03N_2 VREF_2	I/O L03P_2	GND	E		
	I/O	I/O L27N_1	I/O L38N_1	I/O L24N_1	VCCO_1	I/O L17N_1 VREF_1	I/O L36N_1 ◆	I/O L12N_1	I/O L09N_1	I/O	I/O L06P_1	I/O	VCCAUX	I/O L04N_2	I/O L04P_2	I/O L41N_2	I/O L41P_2	F		
	I/O L30N_1	I/O L27P_1	I/O L38P_1	I/O L24P_1	I/O L21N_1	I/O L17P_1	I/O L36P_1 ◆	I/O L12P_1	I/O L09P_1	VCCO_1	GND	I/O L05N_2	I/O L05P_2	I/O L42N_2 ◆	I/O L42P_2 ◆	I/O	I/O	G		
	I/O L30P_1	VCCAUX	VCCO_1	I/O L23N_1	I/O L21P_1	I/O	VCCO_1	I/O L11N_1	I/O	TMS	VCCO_2	I/O L06N_2	I/O L06P_2	I/O L09N_2 VREF_2	VCCO_2	I/O L07N_2	I/O L07P_2	H		
	I/O L29N_1	GND	I/O L37N_1	I/O L23P_1	GND	I/O L16N_1	I/O L35N_1 ◆	I/O L11P_1	I/O	I/O L11N_2	I/O L08N_2	I/O L08P_2	GND	I/O L09P_2	I/O L10N_2	I/O L10P_2	GND	J		
	I/O L29P_1	I/O	I/O L37P_1	I/O VREF_1	I/O L20N_1	I/O L16P_1	I/O L35P_1 ◆	GND	I/O L11P_2	I/O L12N_2	I/O L12P_2	I/O L13N_2	I/O L13P_2 VREF_2	I/O L14N_2	I/O L14P_2	I/O L15N_2	I/O L15P_2	K		
	I/O VREF_1	I/O	I/O	I/O	I/O L20P_1	I/O	I/O	I/O L16N_2	I/O L16P_2	VCCO_2	I/O L17N_2 VREF_2 ◆	VCCAUX	VCCO_2	GND	I/O L45N_2	I/O L45P_2	L			
	VCCINT	VCCO_1	VCCO_1	VCCO_1	VCCO_1	VCCINT	I/O L46N_2	I/O L46P_2	I/O L21N_2	I/O L47N_2	I/O L47P_2	I/O L19N_2	I/O L19P_2	I/O L20N_2	I/O L20P_2	I/O L48N_2	I/O L48P_2	M		
	GND	VCCINT	VCCINT	VCCINT	VCCINT	VCCO_2	I/O L24N_2	I/O L21P_2	GND	I/O L22N_2	I/O L22P_2	VCCO_2	GND	I/O L23N_2 VREF_2	I/O L23P_2	VCCO_2	GND	N		
	GND	GND	GND	GND	VCCINT	VCCO_2	I/O L24P_2	I/O L49N_2 ◆	I/O L49P_2 ◆	I/O L50N_2	I/O L50P_2	I/O L26N_2	I/O L26P_2	I/O L27N_2	I/O L27P_2	I/O L28N_2	I/O L28P_2	P		
	GND	GND	GND	GND	VCCINT	VCCO_2	I/O L29N_2	I/O L29P_2	I/O L33N_2	VCCO_2	I/O L30N_2	I/O L30P_2	VCCAUX	I/O L31N_2	I/O L31P_2	I/O L32N_2	I/O L32P_2	R		
	GND	GND	GND	GND	VCCINT	VCCO_2	I/O L51N_2 ◆	I/O L33P_2	GND	VCCAUX	I/O L34N_2 VREF_2	I/O L34P_2	GND	VCCO_2	I/O L35N_2	I/O L35P_2	GND	T		
	GND	GND	GND	GND	VCCINT	I/O L51P_2 ◆	I/O	I/O	I/O L37N_2	I/O	I/O L37P_2	I/O L38N_2	I/O L38P_2	I/O L39N_2	I/O L39P_2	I/O L40N_2	I/O L40P_2 VREF_2	U		

DS099-4\_14b\_072903

	1	2	3	4	5	6	7	8	9	10	11	12	13	14	15	16	17
<b>V</b>	I/O L40P_6 VREF_6	I/O L40N_6	I/O L39P_6	I/O L39N_6	I/O L38P_6	I/O L38N_6	I/O L52P_6	I/O L52N_6	I/O	I/O	I/O L49P_6 ◆	VCCINT	GND	GND	GND	GND	GND
<b>W</b>	GND	I/O L37P_6	I/O L37N_6	VCCO_6	GND	I/O L36P_6	I/O L36N_6	VCCAUX	GND	I/O L35P_6	I/O L49N_6 ◆	VCCO_6	VCCINT	GND	GND	GND	GND
<b>Y</b>	I/O L34P_6	I/O L34N_6 VREF_6	I/O L33P_6	I/O L33N_6	VCCAUX	I/O L48P_6	I/O L48N_6	VCCO_6	I/O L35N_6	I/O L32P_6	I/O L32N_6	VCCO_6	VCCINT	GND	GND	GND	GND
<b>AA</b>	I/O L31P_6	I/O L31N_6	I/O L30P_6	I/O L30N_6	I/O L29P_6	I/O L29N_6	I/O L28P_6	I/O L28N_6	I/O L46P_6 ◆	I/O L46N_6 ◆	I/O L27P_6	VCCO_6	VCCINT	GND	GND	GND	GND
<b>AB</b>	GND	VCCO_6	I/O L26P_6	I/O L26N_6	GND	VCCO_6	I/O L25P_6	I/O L25N_6	GND	I/O L24P_6	I/O L27N_6	VCCO_6	VCCINT	VCCINT	VCCINT	VCCINT	GND
<b>AC</b>	I/O L23P_6	I/O L23N_6	I/O L45P_6	I/O L45N_6	I/O L22P_6	I/O L22N_6	I/O L21P_6	I/O L21N_6	I/O L24N_6 VREF_6	I/O L20P_6	I/O L20N_6	VCCINT	VCCO_5	VCCO_5	VCCO_5	VCCO_5	VCCO_5
<b>AD</b>	I/O L19P_6	I/O L19N_6	GND	VCCO_6	VCCAUX	I/O L44P_6 ◆	I/O L44N_6 ◆	VCCO_6	I/O L17P_6 VREF_6	I/O L17N_6	I/O	I/O ◆	I/O L16P_5	I/O	I/O	I/O	I/O
<b>AE</b>	I/O L16P_6	I/O L16N_6	I/O L15P_6	I/O L15N_6	I/O L14P_6	I/O L14N_6	I/O L13P_6 VREF_6	I/O L13N_6	I/O L12P_6	GND	I/O L39P_5 ◆	I/O L12P_5	I/O L16N_5	I/O	I/O L23P_5	I/O	I/O L29P_5 VREF_5
<b>AF</b>	GND	I/O L11P_6	I/O L11N_6	I/O L10P_6	GND	I/O L09P_6	I/O L09N_6 VREF_6	I/O L12N_6	I/O ◆	I/O L07P_5	I/O L39N_5 ◆	I/O L12N_5	GND	I/O L19P_5 VREF_5	I/O L23N_5	GND	I/O L29N_5
<b>AG</b>	I/O L08P_6	I/O L08N_6	VCCO_6	I/O L10N_6	I/O L07P_6	I/O L07N_6	VCCO_6	M2	I/O	I/O L07N_5	VCCO_5	I/O	I/O L17P_5	I/O L19N_5	VCCO_5	VCCAUX	I/O L30P_5
<b>AH</b>	I/O	I/O	I/O L41P_6 ◆	I/O L41N_6 ◆	I/O L06P_6	I/O L06N_6	GND	VCCO_5	I/O L37P_5	I/O L08P_5	I/O L40P_5 ◆	I/O L13P_5	I/O L17N_5	I/O L20P_5	I/O L24P_5	I/O L27P_5	I/O L30N_5
<b>AJ</b>	I/O L05P_6	I/O L05N_6	I/O L04P_6	I/O L04N_6	VCCAUX	I/O	I/O L06P_5	I/O VREF_5	I/O L37N_5	I/O L08N_5	I/O L40N_5 ◆	I/O L13N_5	VCCO_5	I/O L20N_5	I/O L24N_5	I/O L27N_5 VREF_5	I/O
<b>AK</b>	GND	I/O L03P_6	I/O L03N_6 VREF_6	M1	GND	VCCAUX	I/O L06N_5	I/O L35P_5	GND	I/O	VCCAUX	I/O L14P_5	GND	I/O	VCCAUX	GND	I/O L31P_5 D5
<b>AL</b>	I/O L02P_6	I/O L02N_6	VCCO_6	M0	I/O VREF_5	I/O L04P_5	I/O L33P_5 ◆	I/O L35N_5	I/O L38P_5	I/O L09P_5	VCCO_5	I/O L14N_5	I/O L18P_5	I/O L21P_5	I/O L25P_5	VCCO_5	I/O L31N_5 D4
<b>AM</b>	I/O L01P_6 VRN_6	I/O L01N_6 VRP_6	GND	VCCO_5	I/O L03P_5	I/O L04N_5	I/O L33N_5 ◆	VCCO_5	I/O L38N_5	I/O L09N_5	GND	I/O	I/O L18N_5	I/O L21N_5	I/O L25N_5	I/O L28P_5 D7	I/O L32P_5 GCLK2
<b>AN</b>	GND	GND	I/O L01P_5 CS_B	I/O L02P_5	I/O L03N_5	I/O L05P_5	I/O L34P_5 ◆	I/O L36P_5	I/O	I/O L10P_5 VRN_5	I/O L11P_5	I/O L15P_5	VCCO_5	I/O L22P_5	I/O L26P_5	I/O L28N_5 D6	I/O L32N_5 GCLK3
<b>AP</b>	GND	GND	I/O L01N_5 RDWR_B	I/O L02N_5	GND	I/O L05N_5	I/O L34N_5 ◆	I/O L36N_5	GND	I/O L10N_5 VRP_5	I/O L11N_5 VREF_5	I/O L15N_5	GND	I/O L22N_5	I/O L26N_5	GND	I/O VREF_5

Bank 5

DS099-4\_14c\_072503

Bottom Left Corner of Package (top view)

18	19	20	21	22	23	24	25	26	27	28	29	30	31	32	33	34	
GND	GND	GND	GND	GND	VCCINT	I/O L51N_3 ◆	I/O L33N_3	I/O	I/O L37P_3	I/O L37N_3	I/O L38P_3	I/O L38N_3	I/O L39P_3	I/O L39N_3	I/O L40P_3	I/O L40N_3 VREF_3	V
GND	GND	GND	GND	VCCINT	VCCO_3	I/O L51P_3 ◆	I/O L33N_3	GND	VCCAUX	I/O L34P_3 VREF_3	I/O L34N_3	GND	VCCO_3	I/O L35P_3	I/O L35N_3	GND	W
GND	GND	GND	GND	VCCINT	VCCO_3	I/O L50P_3	I/O L50N_3	I/O L33P_3	VCCO_3	I/O L30P_3	I/O L30N_3	VCCAUX	I/O L31P_3	I/O L31N_3	I/O L32P_3	I/O L32N_3	Y
GND	GND	GND	GND	VCCINT	VCCO_3	I/O L48N_3	I/O L49P_3 ◆	I/O L49N_3 ◆	I/O L26P_3	I/O L26N_3	I/O L27P_3	I/O L27N_3	I/O L28P_3	I/O L28N_3	I/O L29P_3	I/O L29N_3	A
GND	VCCINT	VCCINT	VCCINT	VCCINT	VCCO_3	I/O L48P_3	I/O L24N_3	GND	I/O L46P_3	I/O L46N_3	VCCO_3	GND	I/O L47P_3	I/O L47N_3	VCCO_3	GND	A
VCCINT	VCCO_4	VCCO_4	VCCO_4	VCCO_4	VCCINT	I/O L20P_3	I/O L20N_3	I/O L24P_3	I/O L21P_3	I/O L21N_3	I/O L22P_3	I/O L22N_3	I/O L23P_3 VREF_3	I/O L23N_3	I/O L45P_3	I/O L45N_3	A
I/O	I/O	I/O	I/O L18N_4	I/O	I/O L11N_4	DONE	I/O L17P_3 VREF_3	I/O L17N_3	VCCO_3	I/O L44P_3 ◆	I/O L44N_3 ◆	VCCAUX	VCCO_3	GND	I/O L19P_3	I/O L19N_3	A
I/O	I/O	I/O L23N_4	I/O L18P_4	I/O	I/O L11P_4	I/O	GND	I/O L12N_3	I/O L13P_3	I/O L13N_3 VREF_3	I/O L14P_3	I/O L14N_3	I/O L15P_3	I/O L15N_3	I/O L16P_3	I/O L16N_3	A
I/O L29N_4	GND	I/O L23P_4	I/O VREF_4	GND	I/O L12N_4	I/O	I/O L07N_4	I/O	I/O L12P_3	I/O L09P_3 VREF_3	I/O L09N_3	GND	I/O L10N_3	I/O L11P_3	I/O L11N_3	GND	A
I/O L29P_4	VCCAUX	VCCO_4	I/O L19N_4	I/O L16N_4	I/O L12P_4	VCCO_4	I/O L07P_4	I/O	I/O	VCCO_3	I/O L07P_3	I/O L07N_3	I/O L10P_3	VCCO_3	I/O L08P_3	I/O L08N_3	A
I/O L30N_4 D2	I/O L27N_4 DIN D0	I/O L24N_4	I/O L19P_4	I/O L16P_4	I/O VREF_4	I/O L39N_4 ◆	I/O L08N_4	I/O L05N_4	VCCO_4	GND	I/O L06P_3	I/O L06N_3	I/O L41P_3 ◆	I/O L41N_3 ◆	I/O	I/O	A
I/O L30P_4 D3	I/O L27P_4 D1	I/O L24P_4	I/O L20N_4	VCCO_4	I/O L13N_4	I/O L39P_4 ◆	I/O L08P_4	I/O L05P_4	I/O	I/O L35N_4	I/O	VCCAUX	I/O L04P_3	I/O L04N_3	I/O L05P_3	I/O L05N_3	A
I/O VREF_4	GND	VCCAUX	I/O L20P_4	GND	I/O L13P_4	VCCAUX	I/O	GND	I/O L38N_4	I/O L35P_4	VCCAUX	GND	N.C. ◆	I/O L03P_3	I/O L03N_3	GND	A
I/O L31N_4 INIT_B	VCCO_4	I/O L25N_4	I/O L21N_4	I/O L17N_4	I/O L14N_4	VCCO_4	I/O L09N_4	I/O L06N_4 VREF_4	I/O L38P_4	I/O L36N_4 ◆	I/O L33N_4	I/O VREF_4	CCLK	VCCO_3	I/O L02P_3	I/O L02N_3 VREF_3	A
I/O L31P_4 DOUT BUSY	I/O L28N_4	I/O L25P_4	I/O L21P_4	I/O L17P_4	I/O L14P_4	GND	I/O L09P_4	I/O L06P_4	VCCO_4	I/O L36P_4 ◆	I/O L33P_4	I/O L03N_4	VCCO_4	GND	I/O L01P_3 VRN_3	I/O L01N_3 VRP_3	A
I/O L32N_4 GCLK1	I/O L28P_4	I/O L26N_4	I/O L22N_4 VREF_4	VCCO_4	I/O L15N_4	I/O L40N_4 ◆	I/O L10N_4	I/O	I/O L04N_4	I/O L37N_4 ◆	I/O L34N_4	I/O L03P_4	I/O L02N_4	I/O L01N_4 VRP_4	GND	GND	A
I/O L32P_4 GCLK0	GND	I/O L26P_4 VREF_4	I/O L22P_4	GND	I/O L15P_4	I/O L40P_4 ◆	I/O L10P_4	GND	I/O L04P_4	I/O L37P_4 ◆	I/O L34P_4	GND	I/O L02P_4	I/O L01P_4 VRN_4	GND	GND	A

Bank 3

Bank 4

DS099-4\_14d\_072903

Bottom Right Corner of Package (top view)

## Revision History

Date	Version No.	Description
04/03/03	1.0	Initial Xilinx release.
04/21/03	1.1	<p>Added information on the VQ100 package footprint, including a complete pinout table (<a href="#">Table 16</a>) and footprint diagram (<a href="#">Figure 8</a>).</p> <p>Updated <a href="#">Table 15</a> with final I/O counts for the VQ100 package. Also added final differential I/O pair counts for the TQ144 package.</p> <p>Added clarifying comments to HSWAP_EN pin description on <a href="#">page 13</a>.</p> <p>Updated the footprint diagram for the FG900 package shown in <a href="#">Figure 15a</a> and <a href="#">Figure 15b</a>. Some thick lines separating I/O banks were incorrect.</p> <p>Made cosmetic changes to <a href="#">Figure 1</a>, <a href="#">Figure 3</a>, and <a href="#">Figure 4</a>.</p> <p>Updated Xilinx hypertext links.</p> <p>Added XC3S200 and XC3S400 to Pin Name column in <a href="#">Table 18</a>.</p>
05/12/03	1.1.1	AM32 pin was missing GND label in FG1156 package diagram ( <a href="#">Figure 16</a> ).
07/11/03	1.1.2	Corrected misspellings of GCLK in <a href="#">Table 1</a> and <a href="#">Table 2</a> . Changed CMOS25 to LVCMOS25 in <a href="#">Dual-Purpose Pin I/O Standard During Configuration</a> section. Clarified references to Module 2. For XC3S5000 in FG1156 package, corrected N.C. symbol to a black square in <a href="#">Table 37</a> , key, and package drawing.
07/29/03	1.2	Corrected pin names on FG1156 package. Some package balls incorrectly included LVDS pair names. The affected balls on the FG1156 package include G1, G2, G33, G34, U9, U10, U25, U26, V9, V10, V25, V26, AH1, AH2, AH33, AH34. The number of LVDS pairs is unaffected. Modified affected balls and re-sorted rows in <a href="#">Table 37</a> . Updated affected balls in <a href="#">Figure 16</a> . Also updated ASCII and Excel electronic versions of FG1156 pinout.
08/19/03	1.2.1	Removed 100 MHz ConfigRate option in <a href="#">CCLK: Configuration Clock</a> section and in <a href="#">Table 11</a> . Added note that TDO is a totem-pole output in <a href="#">Table 9</a> .
10/09/03	1.2.2	Some pins had incorrect bank designations and were improperly sorted in <a href="#">Table 20</a> . No pin names or functions changed. Renamed DCI_IN to DCI and added black diamond to N.C. pins in <a href="#">Table 20</a> . In <a href="#">Figure 10</a> , removed some extraneous text from pin 106 and corrected spelling of pins 45, 48, and 81.
12/17/03	1.3	Added FG320 pin tables and pinout diagram ( <a href="#">FG320: 320-lead Fine-pitch Ball Grid Array</a> ). Made cosmetic changes to the TQ144 footprint ( <a href="#">Figure 9</a> ), the PQ208 footprint ( <a href="#">Figure 10</a> ), the FG676 footprint ( <a href="#">Figure 14</a> ), and the FG900 footprint ( <a href="#">Figure 15</a> ). Clarified wording in <a href="#">Precautions When Using the JTAG Port in 3.3V Environments</a> section.
02/27/04	1.4	Clarified wording in <a href="#">Using JTAG Port After Configuration</a> section. In <a href="#">Table 12</a> , reduced package height for FG320 and increased maximum I/O values for the FG676, FG900, and FG1156 packages.



---

## The Spartan-3 Family Data Sheet

DS099-1, *Spartan-3 FPGA Family: [Introduction and Ordering Information](#)* (Module 1)

DS099-2, *Spartan-3 FPGA Family: [Functional Description](#)* (Module 2)

DS099-3, *Spartan-3 FPGA Family: [DC and Switching Characteristics](#)* (Module 3)

DS099-4, *Spartan-3 FPGA Family: [Pinout Descriptions](#)* (Module 4)