

Absolute Maximum Ratings $T_A=25^\circ\text{C}$

Stresses in excess of the Absolute Maximum Ratings can cause permanent damage to the device. These are absolute stress ratings only. Functional operation of the

device is not implied at these or any other conditions in excess of those given in the operational sections of this document. Exposure to Absolute Maximum Ratings for extended periods of time can adversely affect reliability.

Parameter	Symbol	Test Conditions	LH1527	LH1537	Units
Ambient Operating Temperature Range	T_A	—	-40 to +85	-40 to +85	$^\circ\text{C}$
Storage Temperature Range	T_{stg}	—	-40 to +150	-40 to +150	$^\circ\text{C}$
Pin Soldering Temperature	T_S	$t=10\text{ s max}$	260	260	$^\circ\text{C}$
Input/Output Isolation Voltage	V_{ISO}	—	3750	3750	V_{rms}
Pole-to-Pole Isolation Voltage* (S1 to S2)	—	Dry air, dust free, at sea level	1600	1600	V
LED Continuous Forward Current	I_F	—	50	50	mA
LED Reverse Voltage	V_R	$I_R \leq 10\ \mu\text{A}$	8	8	V
dc or Peak ac Load Voltage	V_L	$I_L \leq 50\ \mu\text{A}$	350	250	V
Continuous dc Load Current (Form C Operation)	I_L	—	125	150	mA
Peak Load Current	I_P	$t=100\text{ ms}$ (single shot)	350	500	mA
Output Power Dissipation (continuous) 6-Pin Package	P_{DISS}	—	500	500	mW
8-Pin Package			600	600	mW

* Breakdown occurs between the output pins external to the package.

Recommended Operating Conditions

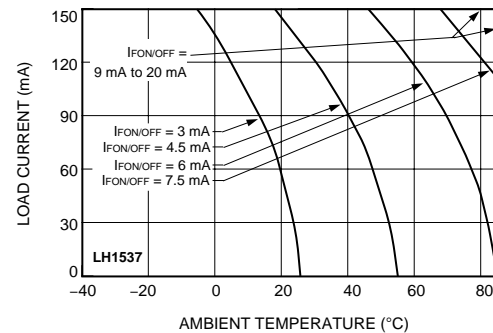
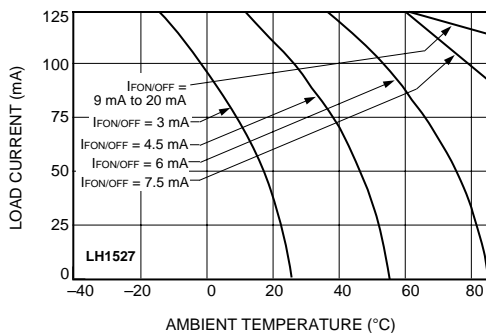

Electrical Characteristics $T_A=25^\circ\text{C}$

Minimum and maximum values are testing requirements.
Typical values are characteristics of the device and are the

result of engineering evaluations. Typical values are for information purposes only and are not part of the testing requirements.

	Parameter	Symbol	Test Condition	Values	LH1527	LH1537	Units	
INPUT	LED Forward Current for Switch Turn-on (NO)	I_{Fon}	$I_L=100\text{ mA}$ $t=10\text{ ms}$	Min	—	—	mA	
				Typ	2.0	2.0	mA	
				Max	3.0	3.0	mA	
	LED Forward Current for Switch Turn-off (NO)	I_{Foff}	—	Min	0.2	0.2	mA	
				Typ	1.0	1.0	mA	
				Max	—	—	mA	
	LED Forward Current for Switch Turn-on (NC)	I_{Fon}	$I_L=100\text{ mA}$ $t=10\text{ ms}$	Min	0.2	0.2	mA	
				Typ	0.6	0.6	mA	
				Max	—	—	mA	
	LED Forward Current for Switch Turn-off (NC)	I_{Foff}	—	Min	—	—	mA	
				Typ	0.7	0.7	mA	
				Max	3.0	3.0	mA	
	LED Forward Voltage	V_F	$I_F=10\text{ mA}$	Min	1.15	1.15	V	
				Typ	1.26	1.26	V	
				Max	1.45	1.45	V	
OUTPUT	ON-resistance: (NO, NC)	R_{ON}	$I_F=5\text{ mA (NO)}$, 0 mA (NC) $I_L=50\text{ mA (NC)}$	Min	17*	8	Ω	
				Typ	25*	12	Ω	
				Max	33*	16	Ω	
	OFF-resistance (NO)	R_{OFF}	$I_F=0\text{ mA}$ $V_L=\pm 100\text{ V}$	Min	0.5	0.5	$\text{G}\Omega$	
				Typ	600	600	$\text{G}\Omega$	
				Max	—	—	$\text{G}\Omega$	
			(NC)	$I_F=5\text{ mA}$ $V_L=\pm 100\text{ V}$	Min	0.1	0.1	$\text{G}\Omega$
					Typ	5.0	5.0	$\text{G}\Omega$
					Max	—	—	$\text{G}\Omega$
	Off-state Leakage Current (NO) (NC)	—	$I_F=0\text{ mA}$ $V_L=\pm 100\text{ V}$	Min	—	—	nA	
				Typ	0.17	0.17	nA	
				Max	200	200	nA	
			(NO, NC)	$I_F=5\text{ mA}$ $V_L=\pm 100\text{ V}$	Min	—	—	μA
					Typ	0.02	0.02	μA
					Max	1.0	1.0	μA
			(NO, NC)	$I_F=0\text{ mA (NO)}$ $I_F=5\text{ mA (NC)}$	Min	—	—	μA
					Typ	—	—	μA
					Max	1.0	1.0	μA
	Output Capacitance (NO) (NC)	—	$I_F=0\text{ mA}$ $V_L=1\text{ V}$	Min	—	—	pF	
				Typ	55	60	pF	
				Max	—	—	pF	
			(NC)	$I_F=0\text{ mA}$ $V_L=50\text{ V}$	Min	—	—	pF
					Typ	10	15	pF
					Max	—	—	pF
(NC)			$I_F=5\text{ mA}$ $V_L=1\text{ V}$	Min	—	—	pF	
				Typ	35	45	pF	
				Max	—	—	pF	
(NC)			$I_F=5\text{ mA}$ $V_L=50\text{ V}$	Min	—	—	pF	
				Typ	10	15	pF	
				Max	—	—	pF	

	Parameter	Symbol	Test Condition	Values	LH1527	LH1537	Units
O U T P U T	Pole-to-pole Capacitance (S1 to S2)	—	$I_F=0$ mA	Min	—	—	pF
				Typ	0.5	0.5	pF
				Max	—	—	pF
	Switch Offset (NO)	—	$I_F=5$ mA (NO) $I_F=5$ mA (NC)	Min	—	—	μ V
				Typ	0.15	0.15	μ V
				Max	—	—	μ V
	Switch Offset (NC)	—	$I_F=0$ mA (NC) $I_F=5$ mA (NO)	Min	—	—	μ V
				Typ	0.1	0.1	μ V
				Max	—	—	μ V
T R A N S F E R	Input/Output Capacitance	C_{ISO}	$V_{ISO}=1$ V	Min	—	—	pF
				Typ	1.1	1.1	pF
				Max	—	—	pF
	Turn-on Time (NO)	t_{on}	$I_F=10$ mA $I_L=37.5$ mA $V_L=150$ V*	Min	0.5	0.5	ms
				Typ	3.1	3.1	ms
				Max	4.5	4.5	ms
	Turn-on Time (NC)	t_{on}	$I_F=6$ mA $I_L=100$ mA $V_L=50$ V*	Min	0.5	0.5	ms
				Typ	2.3	2.3	ms
				Max	4.5	4.5	ms
	Turn-off Time (NO)	t_{off}	$I_F=1$ mA $I_L=37.5$ mA $V_L=STC$ V*	Min	—	—	ms
				Typ	1.2	1.2	ms
				Max	4.5	4.5	ms
	Turn-off Time (NC)	t_{off}	$I_F=10$ mA $I_L=37.5$ mA $V_L=150$ V*	Min	—	—	ms
				Typ	1.6	1.6	ms
				Max	4.5	4.5	ms
	Transfer OFF Time (NC off to NO on)	$ttfr$	$I_F=10$ mA $I_L=37.5$ mA $V_L=150$ V*	Min	0	0	ms
				Typ	0.6	0.6	ms
				Max	—	—	ms

* Single application.

A. LED Voltage vs. Temperature

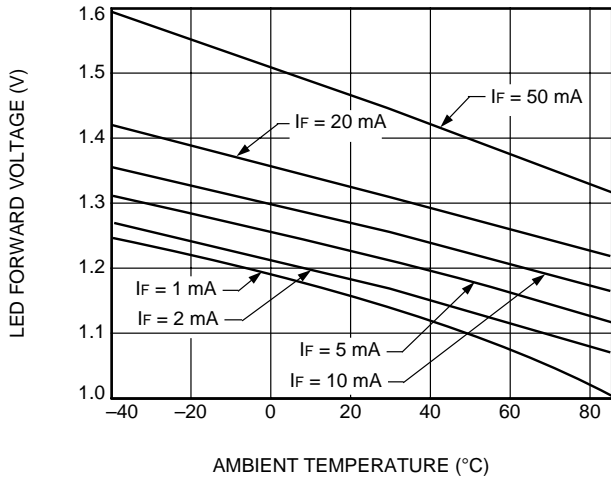

B. LED Dropout Voltage vs. Temperature

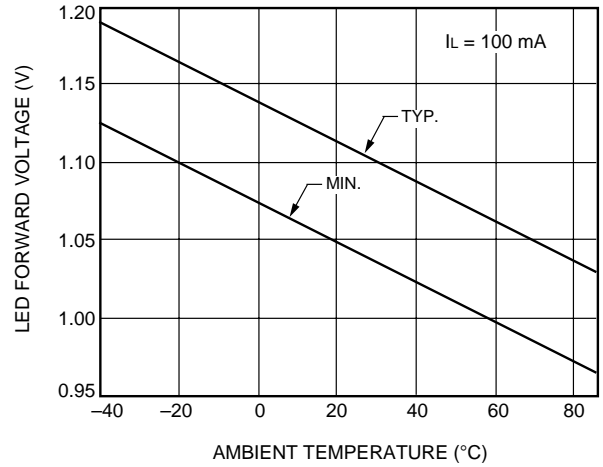

C. LED Current for Switch Turn-Off vs. Temperature

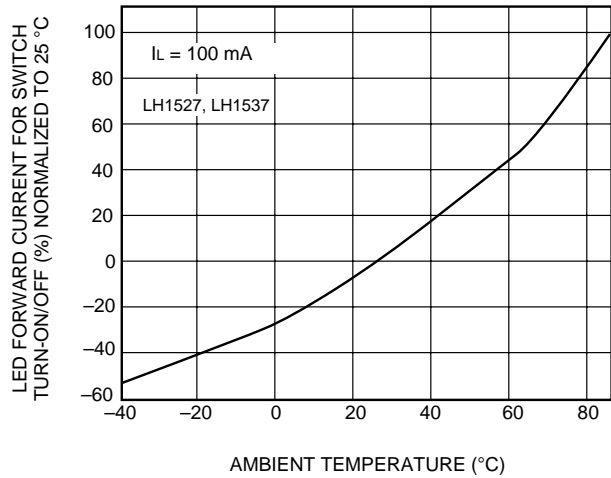

D. ON-Resistance vs. Temperature

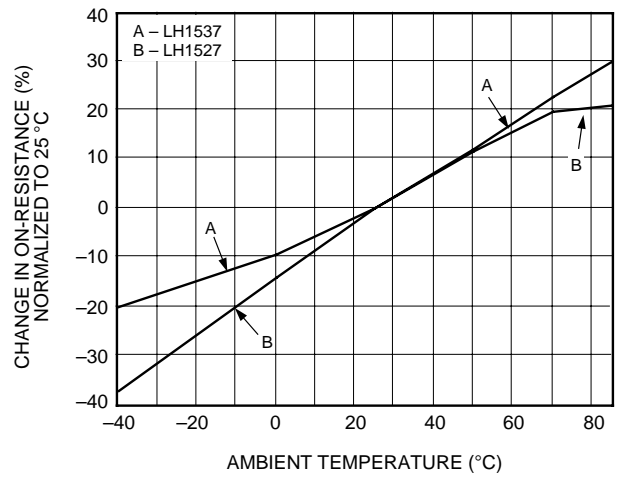

E. Variation in ON-Resistance vs. LED Current

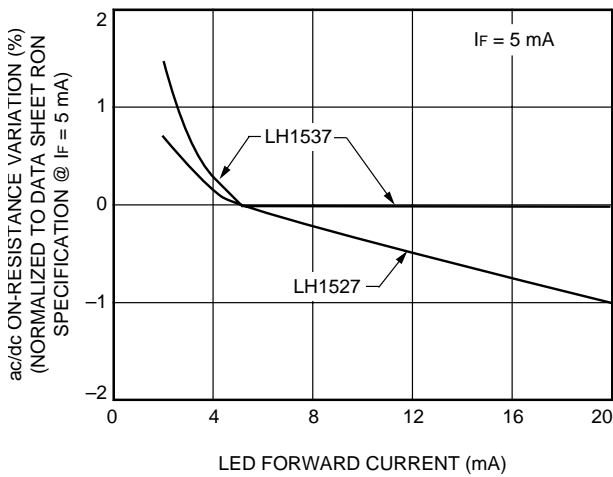

F. Switch Capacitance vs. Applied Voltage

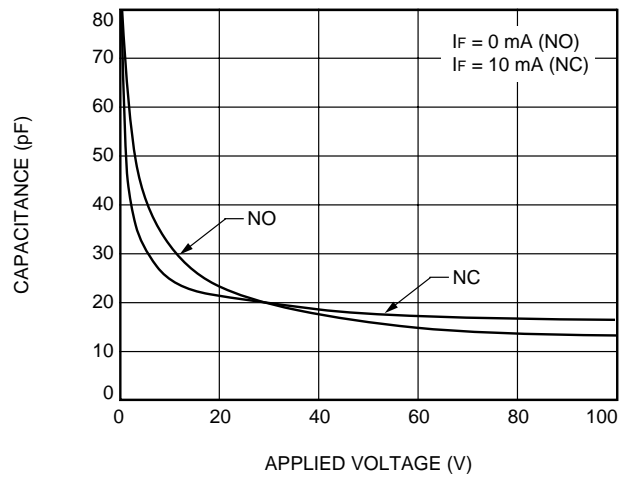

A. Insertion Loss vs. Frequency

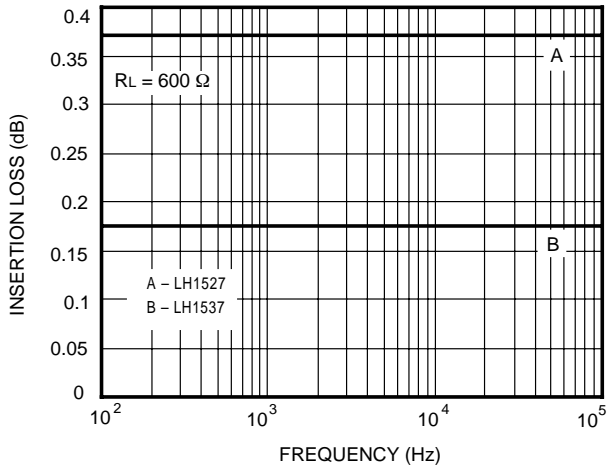

B. Output Isolation

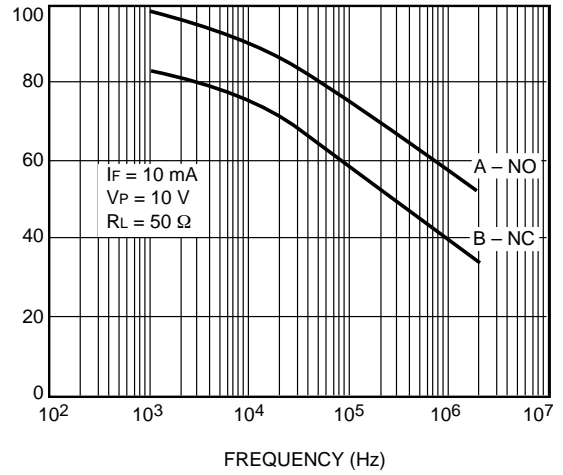

C. Leakage Current vs. Applied Voltage (NO)

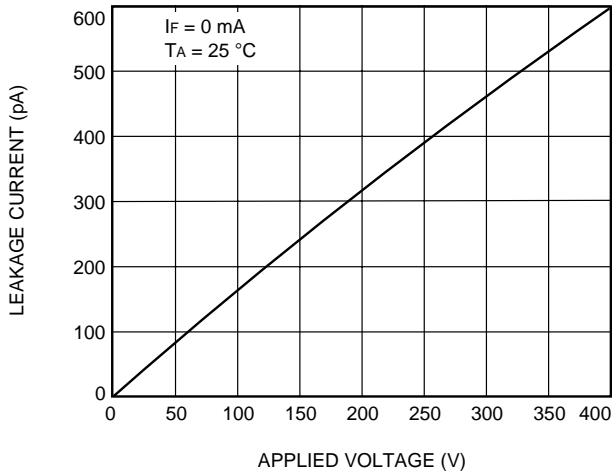

D. Leakage Current vs. Applied Voltage at Elevated Temperatures (NO)

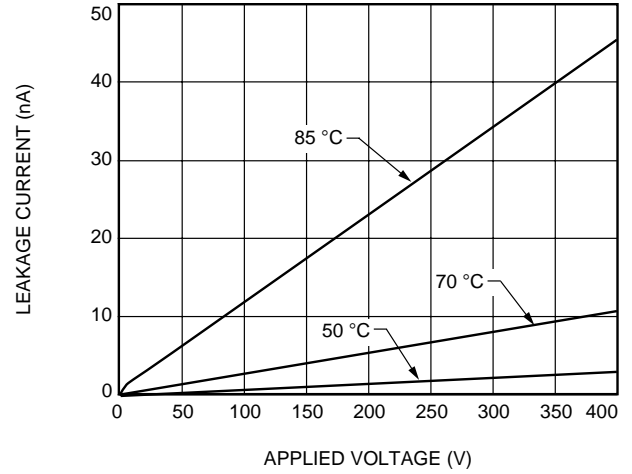

E. Leakage Current vs. Applied Voltage (NC)

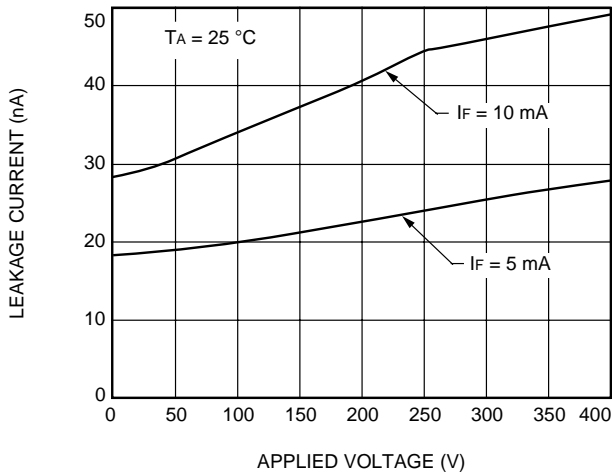

F. Leakage Current vs. Applied Voltage at Elevated Temperatures (NC)

A. Switch Breakdown Voltage vs. Temperature

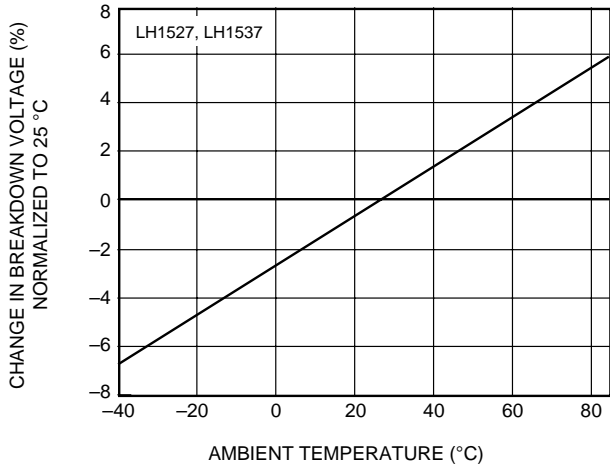

B. Switch Offset Voltage vs. Temperature

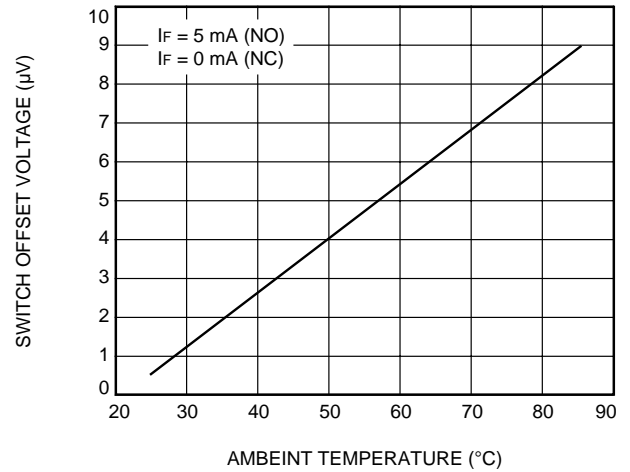

C. Switch Offset Voltage vs. LED Current

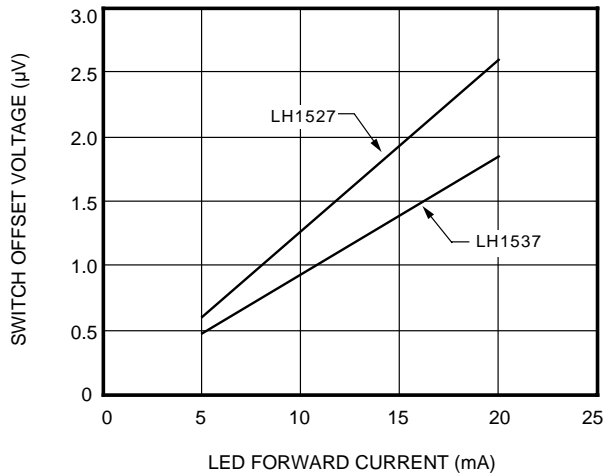

D. t_{on}/t_{off} vs. Temperature

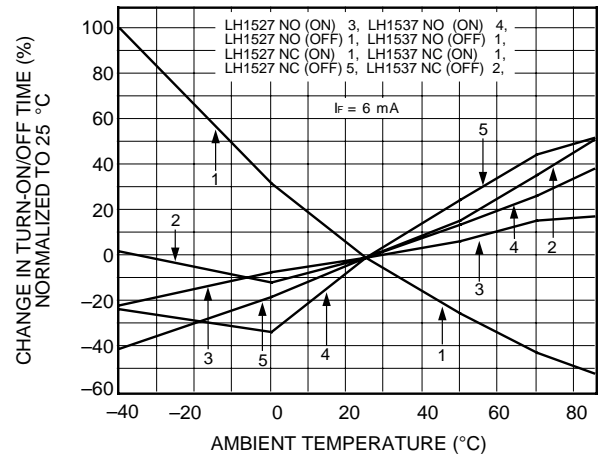

E. NO Turn-On Time vs. LED Current

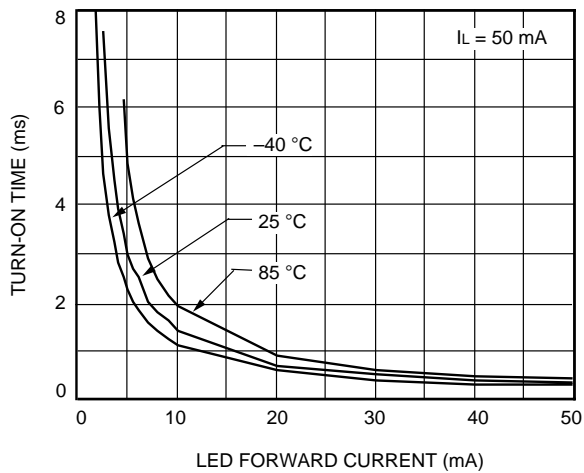

F. NC Turn-Off Time vs. LED Current

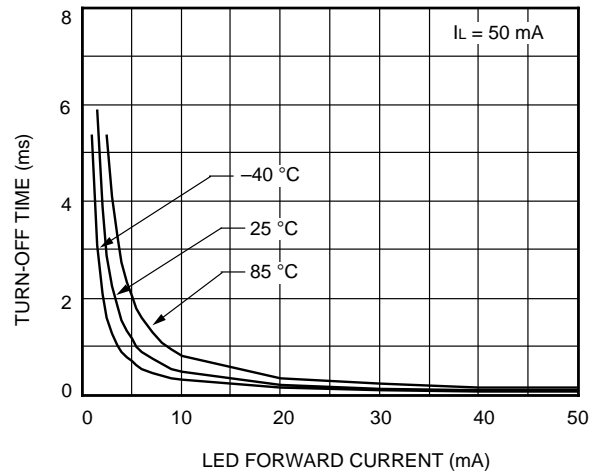

A. NC Turn-On Time vs. LED Current

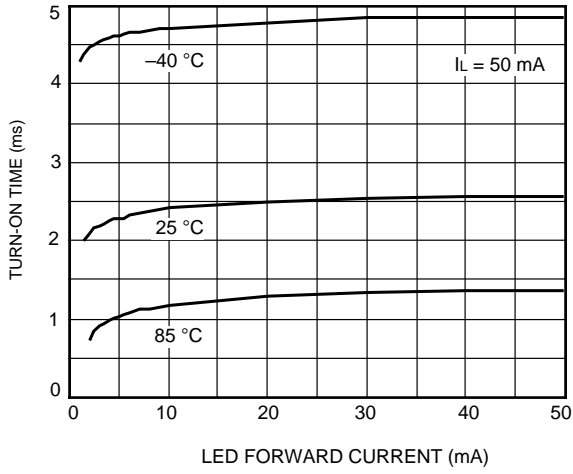

B. NO Turn-Off Time vs. LED Current

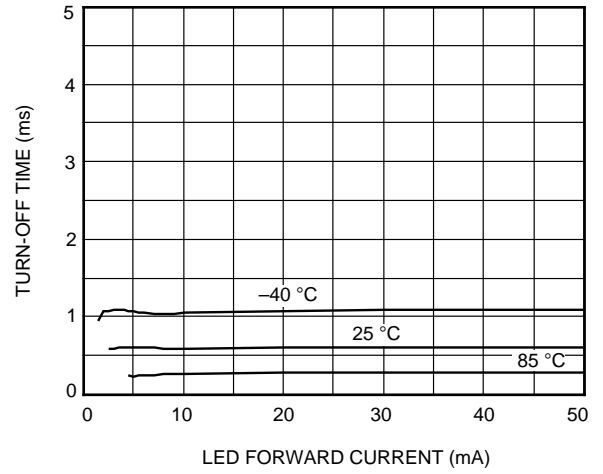

- Very low operating current

FEATURES

- High-speed operation
- 1500 Vrms I/O isolation
- Current-limit protection
- High surge capability
- Linear, ac/dc operation
- Clean, bounce-free switching
- Extremely low power consumption
- High-reliability monolithic receptor
- Surface-mountable

APPLICATIONS

- PCMCIA Type 2 cards
- Battery powered switch applications
- General telecom switching
- Telephone line interface
 - On/off hook
 - Ring relay
 - Ground start
- Programmable controllers
- Instrumentation

DESCRIPTION

The LH1525 relay is an SPST normally open switch (1 Form A and Dual 1 Form A respectively) in small-outline packages (SOP). They require a minimal amount of LED drive current to operate, making them ideal for battery powered and power consumption sensitive applications.

The relays are constructed using a GaAlAs LED for actuation control and an integrated monolithic die for the switch output. The die, fabricated in a high-voltage dielectrically isolated BCDMOS technology, is comprised of a photodiode array, switch-control circuitry, and MOSFET switches. In addition, the relays employ current-limiting circuitry enabling it to pass FCC 68.302 and other regulatory surge requirements when overvoltage protection is provided.

The LH1525 (1 Form A) is packaged in an 8-pin, plastic SOP (LH1525ACD). Available in sticks or on tape and reel.

Figure 1. LH1525ACD Functional/Pin Diagram

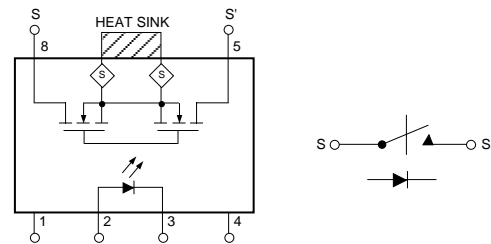

Functional Description

Figure 3 shows the switch characteristics of the relays. The relay exhibits an ON-resistance that is exceptionally linear through the origin and up to the knee current (I_k). Beyond I_k , the incremental resistance decreases, minimizing internal power dissipation. Overload currents are clamped at I_{LMT} by the internal current-limit circuitry. The current-limiting circuitry exhibits a negative temperature coefficient, thereby reducing the current-limit value when relay temperature is increased. An extended clamp condition, which increases relay temperature, decreases the current-limit value, resulting in a current foldback characteristic. When the overload is removed, the relay resumes its normal ON-resistance characteristic.

Figure 3. Typical ac/dc ON Characteristics

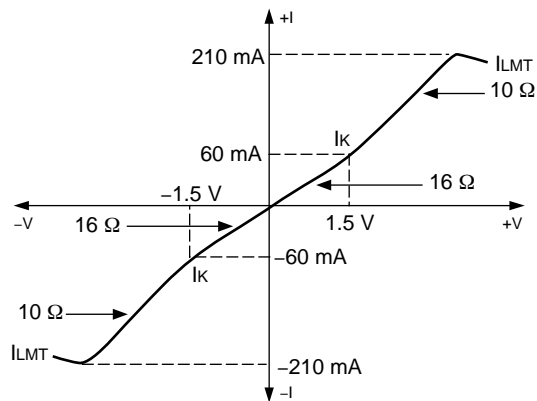

Absolute Maximum Ratings At 25°C

Stresses in excess of the Absolute Maximum Ratings can cause permanent damage to the device. These are absolute stress ratings only. Functional operation of the device is not implied at these or any other conditions in

In a 1 Form A relay, to turn the relay on, forward current is applied to the LED. The amount of current applied determines the amount of light produced for the photodiode array. This photodiode array develops a drive-voltage for the MOSFET switch outputs. For high-temperature or high-load current operations, more LED current is required.

Thermal Considerations

To minimize thermal resistance, pins 6 and 7 of the LH1525ACD are formed into a tab. This tab should be soldered to a printed circuit board land pattern of equal or greater size. **Do Not** run metal underneath the device or the input-to-output isolation could be jeopardized.

excess of those given in the operational sections of the data sheet. Exposure to Absolute Maximum Ratings for extended periods can adversely affect the device reliability.

Parameter	Symbol	Value	Unit
Ambient Operating Temperature Range	T_A	-40 to +85	°C
Storage Temperature Range	T_{stg}	-55 to +150	°C
Pin Soldering Temperature (t=5 s max.)	T_S	260	°C
Input/Output Isolation Voltage	V_{ISO}	1500	Vrms
LED Input Ratings:			
Continuous Forward Current	I_F	50	mA
Reverse Voltage	V_R	5	V
Output Operation:			
dc or Peak ac Load Voltage ($I_L \leq 50 \mu A$)	V_L	400	V
Continuous dc Load Current:			
One pole operating	I_L	110	mA
Power Dissipation:			
LH1525	P_{DISS}	550	mW
Thermal Resistance, Junction to Ambient	$R_{\theta JA}$	120	C/W

Recommended Operating Conditions

Parameter	Symbol	Min	Typ	Max	Unit
LED Forward Current for Switch Turn-on ($T_A = -40^\circ\text{C}$ to $+85^\circ\text{C}$)	I_{FON}	1.5	—	20	mA

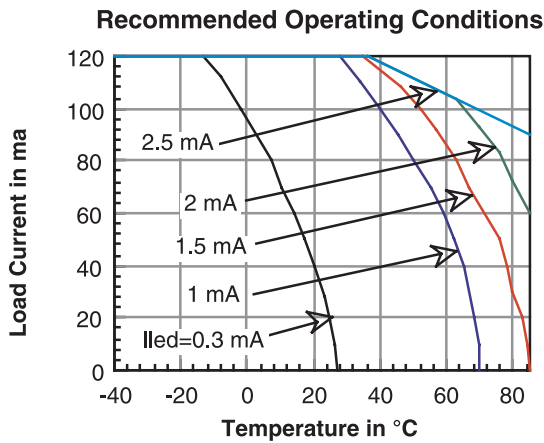

Electrical Characteristics $T_A = 25^\circ\text{C}$

Minimum and maximum values are testing requirements. Typical values are characteristics of the device

and are the result of engineering evaluations. Typical values are for information purposes only and are not part of the testing requirements.

Parameter	Symbol	Test Condition	Min	Typ	Max	Unit
LED Forward Current for Switch Turn-on	I_{FON}	$I_L = 100$ mA, $t = 10$ ms	—	0.2	0.5	mA
LED Forward Current for Switch Turn-off	I_{FOFF}	$V_L = \pm 350$ V, $t = 100$ ms	0.01	0.1	—	mA
LED Forward Voltage	V_F	$I_F = 1.5$ mA	0.80	1.15	1.40	V
ON-resistance: Pin 4 (\pm) to 6 (\pm)	R_{ON}	$I_F = 1.5$ mA, $I_L = \pm 50$ mA	17	25	33	Ω
Current Limit	I_{LMT}	$I_F = 1.5$ mA, $t = 5$ ms, $V_L = 7$ V	170	210	270	mA
Output Off-state Leakage Current	—	$I_F = 0$ mA, $V_L = \pm 100$ V $V_L = \pm 400$ V	—	0.04	200	nA μA
Turn-on Time	t_{on}	$I_F = 1.5$ mA, $I_L = 50$ mA $I_F = 5.0$ mA, $I_L = 50$ mA	—	1.0	—	ms
Turn-off Time	t_{off}	$I_F = 1.5$ mA, $I_L = 50$ mA $I_F = 5.0$ mA, $I_L = 50$ mA	—	0.2	—	ms
			—	0.25	0.5	ms

FEATURES

- Load voltage, 350 V
- Load current 70 mA
- TR_{ON} , typical at 100 mA
- 3750 Vrms I/O isolation
- Current-limit protection
- High-surge capability
- Linear, ac/dc or dc operation
- Clean, bounce-free switching
- Low power consumption
- High-reliability monolithic receptor
- Surface-mountable

APPLICATIONS

- General telecom switching
 - On/off-hook
 - Dial pulse
 - Ground start
 - Ground fault protection
- Instrumentation
- Industrial controls
- Peripherals

DESCRIPTION

The LH1533 (Dual 1 Form A) relays are SPST normally open switches that can replace electromechanical relays in many applications. The relays are constructed using a GaAlAs LED for actuation control and an integrated monolithic die for the switch output. The die, fabricated in a high-voltage dielectrically isolated BICMOS technology, is comprised of a photodiode array, switch control circuitry, and MOSFET switches. In addition, the relay employs current-limiting circuitry enabling it to pass FCC 68.302 and other regulatory voltage surge requirements when overvoltage protection is provided.

The LH1533 (Dual 1 Form A) relay is packaged in an 8-pin DIP (LH1533AB) or in a surface-mount, option 9 (LH1533AAC). The surface-mount devices are available in sticks or on tape and reel.

Figure 1. Functional Diagram

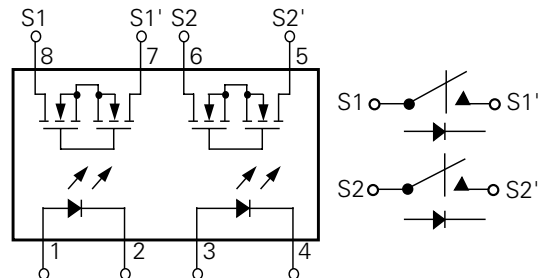

Absolute Maximum Ratings $T_A=25^\circ\text{C}$

Stresses in excess of the Absolute Maximum Ratings can cause permanent damage to the device. These are absolute stress ratings only. Functional operation of the device is not implied at these or any other condition in

excess of those given in the operational sections of the data sheet. Exposure to Absolute Maximum Ratings for extended periods can adversely affect the device reliability.

Parameter	Symbol	Value	Unit
Ambient Operating Temperature Range	T_A	-40 to +85	$^\circ\text{C}$
Storage Temperature Range	T_{stg}	-40 to +150	$^\circ\text{C}$
Pin Soldering Temperature (t=10 s max.)	T_S	260	$^\circ\text{C}$
Input/Output Isolation Test Voltage (t=1 sec)	V_{ISO}	5300	Vrms
LED Input Ratings: Continuous Forward Current Reverse Voltage ($I_R \leq 10 \mu\text{A}$)	I_F V_R	50 5	mA V
Output Ratings: dc or Peak ac Load Voltage ($I_L \leq 50 \mu\text{A}$) Continuous dc Load Current LH1533 (One Pole Operating) LH1533 (Two Poles Operating)	V_L I_L I_L	350 90 70	V mA mA
Power Dissipation LH1533	P_{DISS}	600	mW

Electrical Characteristics $T_A=25^\circ\text{C}$

Minimum and maximum values are testing requirements. Typical values are characteristics of the device

and are the result of engineering evaluations. Typical values are for information purposes only and are not part of the testing requirements.

Parameter	Symbol	Test Condition	Min	Typ	Max	Unit
LED Forward Current for Switch Turn-on	I_{Fon}	$I_L=100 \text{ mA}$, t=10 ms	-	-	2.5	mA
LED Forward Current for Switch Turn-off	I_{Foff}	$V_L=\pm 300 \text{ V}$	0.01	-	-	mA
LED Forward Voltage	V_F	$I_F=5 \text{ mA}$	0.9	1.2	1.4	V
ON-resistance	R_{ON}	$I_F=5 \text{ mA}$, $I_L=\pm 90 \text{ mA}$	25	37	50	Ω
Current Limit	I_{LMT}	$I_F=5 \text{ mA}$, t=5 ms, $V_L=13 \text{ V}$	150	200	270	mA
Output Off-state Leakage Current	-	$I_F=0 \text{ mA}$, $V_L=\pm 350 \text{ V}$	-	-	1.0	μA
Turn-on Time	t_{on}	$I_F=5 \text{ mA}$, $I_L=50 \text{ mA}$	-	-	3.0	ms
Turn-off Time	t_{off}	$I_F=5 \text{ mA}$, $I_L=50 \text{ mA}$	-	-	3.0	ms

FEATURES

	LH1525	LH1526	Units
Load Voltage	400	400	V
Load Current			
ac/dc	120	120	mA
dc	250	250	mA
Typical R _{ON}	25	25	Ω
Typical Operating Current	500	500	μA
t _{on} /t _{off} (max)	0.8/0.4	0.8/0.4	ms
Current Limit:			
ac/dc	Yes	Yes	—

- Extremely low operating current
- High-speed operation
- 3750 Vrms I/O isolation
- Current-limit protection
- High surge capability
- Linear, ac/dc operation
- dc-only option
- Clean, bounce-free switching
- Low power consumption
- High-reliability monolithic receptor
- Surface-mountable

APPLICATIONS

- General telecom switching:
 - Telephone line interface
 - On/off hook
 - Ring relay
 - Break switch
 - Ground start
- Battery-powered switch applications
- Industrial controls:
 - Microprocessor control of solenoids, lights, motors, heaters, etc.
- Programmable controllers
- Instrumentation

DESCRIPTION

The LH1525 and LH1526 relays are SPST normally open switches (1 Form A) that can replace electromechanical relays in many applications. The relays require a minimal amount of LED drive current to operate, making it ideal for battery-powered and power consumption sensitive applications. The relay is constructed using a GaAlAs LED for actuation control and an integrated monolithic die for the switch output. The die, fabricated in a high-voltage dielectrically isolated BCDMOS technology, comprised of a photo-diode array, switch-control circuitry, and MOSFET switches. In addition, the relay employs current-limiting circuitry, enabling it to pass FCC 68.302 and other regulatory surge requirements when overvoltage protection is provided. The relay can be configured for ac/dc or dc-only operation.

The LH1525 is packaged in a 6-pin, plastic DIP (LH1525AT) or in a surface-mount gull wing (LH1525AAB). The LH1526 is packaged in a 8-pin, plastic DIP (LH1526AB) or in a surface-mount gull wing (LH1526AAC). Both devices are available in sticks or on tape and reel.

Absolute Maximum Ratings $T_A=25^\circ\text{C}$

Stresses in excess of the Absolute Maximum Ratings can cause permanent damage to the device. These are absolute stress ratings only. Functional operation of the

device is not implied at these or any other conditions in excess of those given in the operational sections of the data sheet. Exposure to Absolute Maximum Ratings for extended periods can adversely affect device reliability.

Parameter	Symbol	Value	Unit
Ambient Operating Temperature Range	T_A	-40 to +85	$^\circ\text{C}$
Storage Temperature Range	T_{stg}	-40 to +150	$^\circ\text{C}$
Pin Soldering Temperature (t=10 s max.)	T_S	260	$^\circ\text{C}$
Input/Output Isolation Test Voltage (t=1 sec)	V_{ISO}	5300	Vrms
LED Input Ratings: Continuous Forward Current Reverse Voltage	I_F V_R	50 8	mA V
Output Operation LH1525, LH1526 (ea. ch.): dc or Peak ac Load Voltage ($I_L \leq 50 \mu\text{A}$) Continuous dc Load Current: Bidirectional Operation, Pin 4 to 6 (LH1525) Unidirectional Operation, Pins 4, 6 (+) to Pin 5 (-)	V_L I_L I_L	400 125 250	V mA mA
Two Role Operation (LH1526 only)	I_L	100	mA
Power Dissipation: LH1525 LH1526	P_{DISS} P_{DISS}	550 600	mW mW

Recommended Operating Conditions

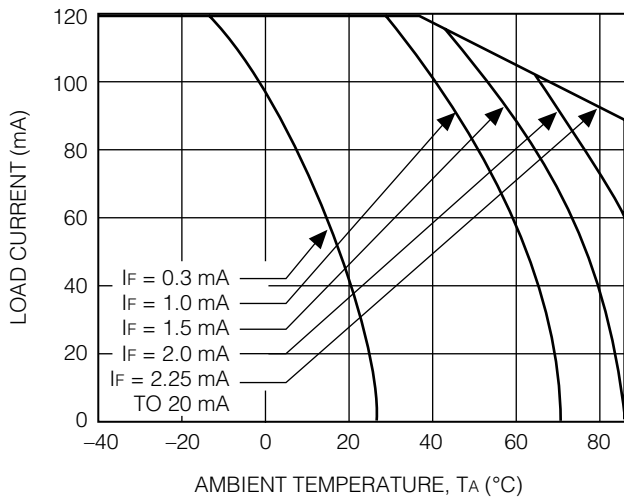

Electrical Characteristics $T_A=25^\circ\text{C}$

Minimum and maximum values are testing requirements. Typical values are characteristics of the device

and are the result of engineering evaluations. Typical values are for information purposes only and are not part of the testing requirements.

Parameter	Symbol	Test Condition	Min	Typ	Max	Unit
Input						
LED Forward Current for Switch Turn-on	I_{Fon}	$I_L=100\text{ mA}$, $t=10\text{ ms}$	—	0.3	0.5	mA
LED Forward Current for Switch Turn-off	I_{Foff}	$V_L=\pm 350\text{ V}$, $t=100\text{ ms}$	0.001	0.1	—	mA
LED Forward Voltage	V_F	$I_F=1.5\text{ mA}$	0.80	1.15	1.40	V
Output						
ON-resistance: ac/dc, each pole dc Pins 4, 6 (+) to 5 (-) (LH1525 only)	R_{ON}	$I_F=1.5\text{ mA}$, $I_L=\pm 50\text{ mA}$ $I_F=1.5\text{ mA}$, $I_L=100\text{ mA}$	17 4.25	25 6.25	33 8.25	Ω Ω
OFF-resistance	R_{OFF}	$I_F=0\text{ mA}$, $V_L=\pm 100\text{ V}$	—	5000	—	$G\Omega$
Current Limit	I_{LMT}	$I_F=1.5\text{ mA}$, $t=5\text{ ms}$, $V_L=7\text{ V}$	170	210	270	mA
Output Off-state Leakage Current	—	$I_F=0\text{ mA}$, $V_L=\pm 100\text{ V}$ $I_F=0\text{ mA}$, $V_L=\pm 400\text{ V}$	— —	0.04 —	200 1.0	nA μA
Output Capacitance	—	$I_F=0\text{ mA}$, $V_L=1\text{ V}$ $I_F=0\text{ mA}$, $V_L=50\text{ V}$	— —	37 13	— —	pF pF
Switch Offset	—	$I_F=5\text{ mA}$	—	0.25	—	μV
Transfer						
Input/Output Capacitance	C_{ISO}	$V_{ISO}=1\text{ V}$	—	0.8	—	pF
Turn-on Time	t_{on}	$I_F=1.5\text{ mA}$, $I_L=50\text{ mA}$ $I_F=5.0\text{ mA}$, $I_L=50\text{ mA}$	— —	1.00 0.25	— 0.8	ms ms
Turn-off Time	t_{off}	$I_F=1.5\text{ mA}$, $I_L=50\text{ mA}$ $I_F=5.0\text{ mA}$, $I_L=50\text{ mA}$	— —	0.20 0.25	— 0.4	ms ms

Typical Performance Characteristics

A. LED Voltage vs. Temperature

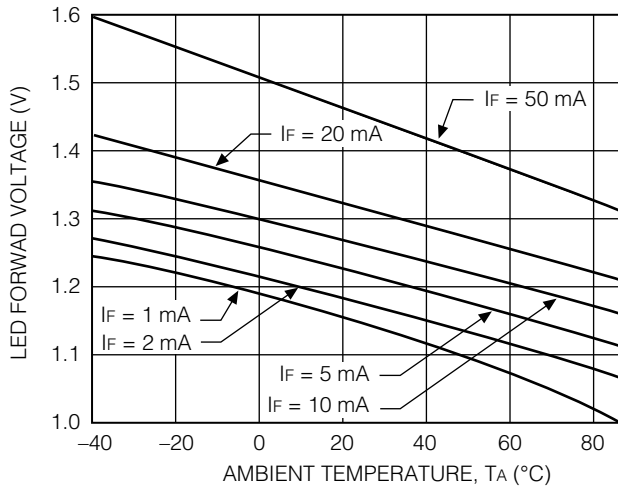

B. LED Dropout Voltage vs. Temperature

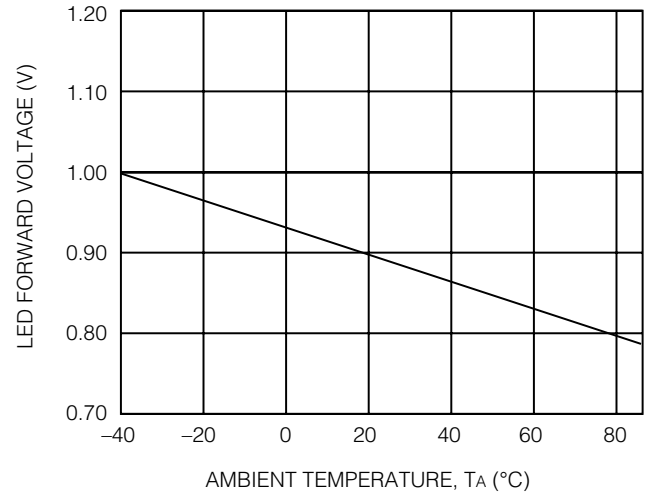

C. LED Current for Switch Turn-On/Off vs. Temperature

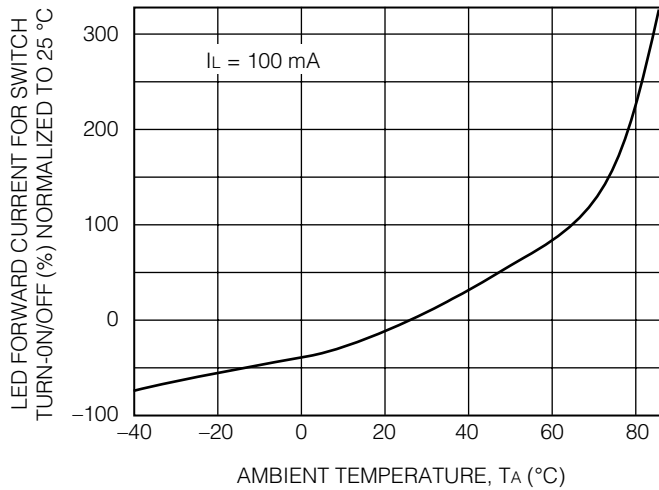

D. Current Limit vs. Temperature

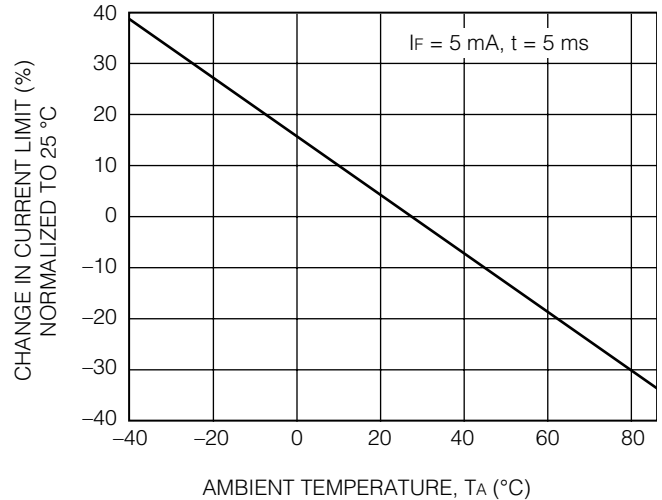

E. ON-Resistance vs. Temperature

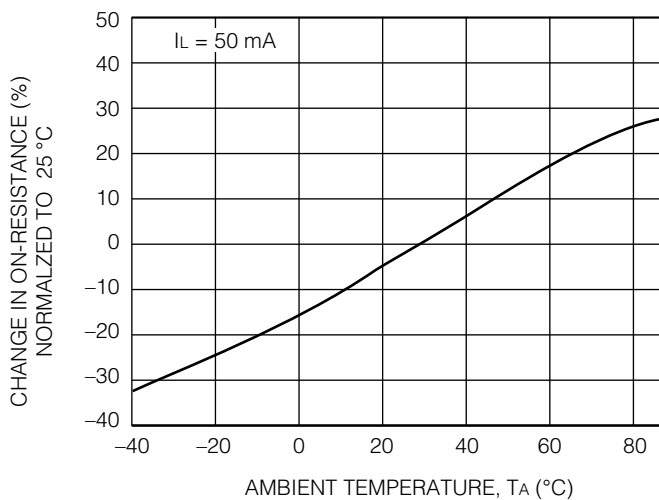

F. Variation in ON-Resistance vs. LED Current

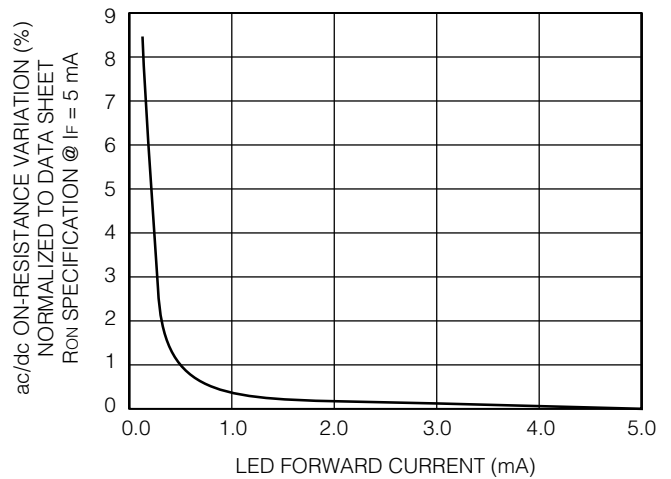

Typical Performance Characteristics (continued)

A. Switch Capacitance vs. Applied Voltage

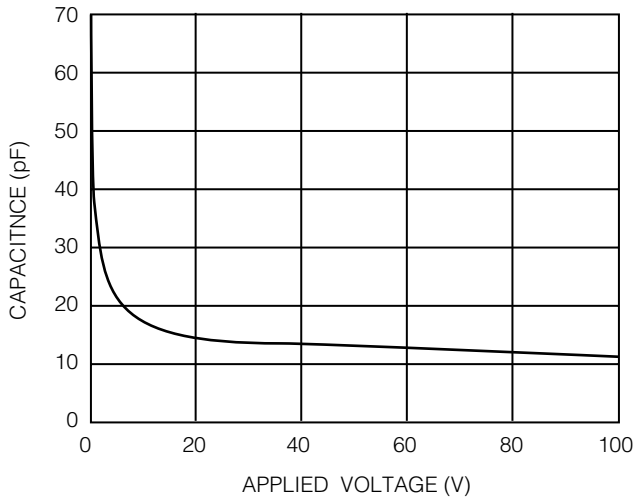

B. Insertion Loss vs. Frequency

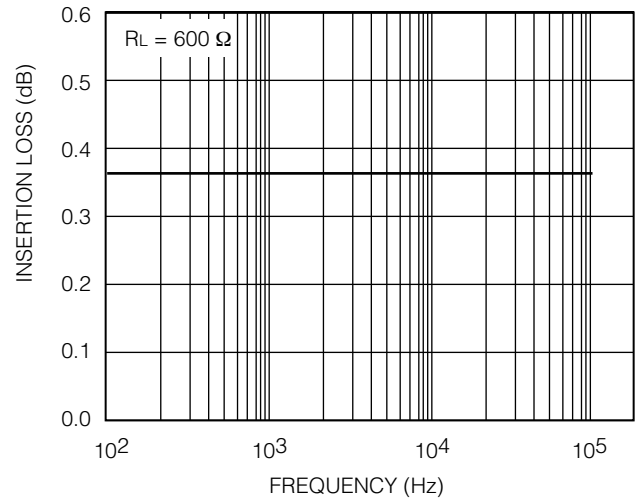

C. Output Isolation

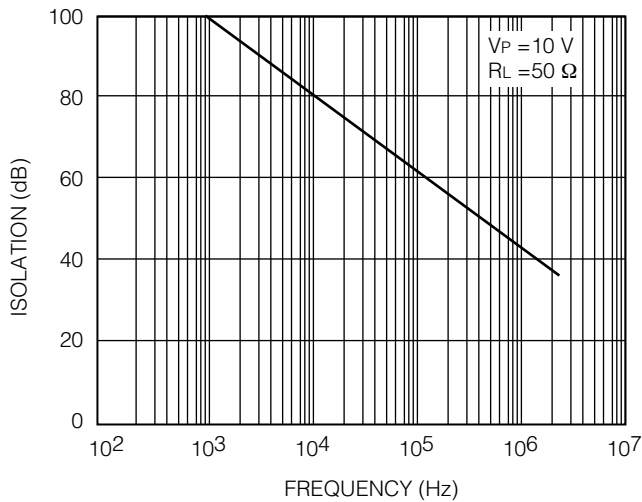

D. Leakage Current vs. Applied Voltage

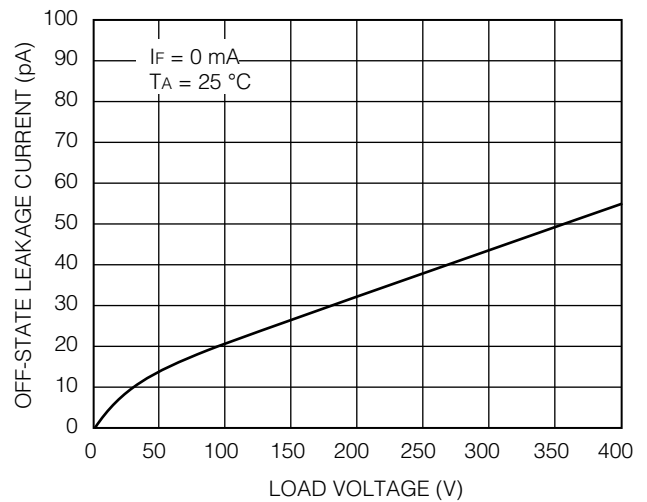

E. Leakage Current vs. Applied Voltage at Elevated Temperatures

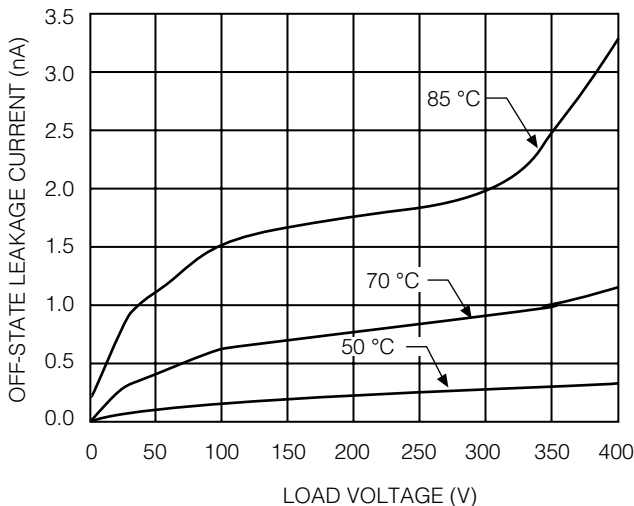

F. Switch Breakdown Voltage vs. Temperature

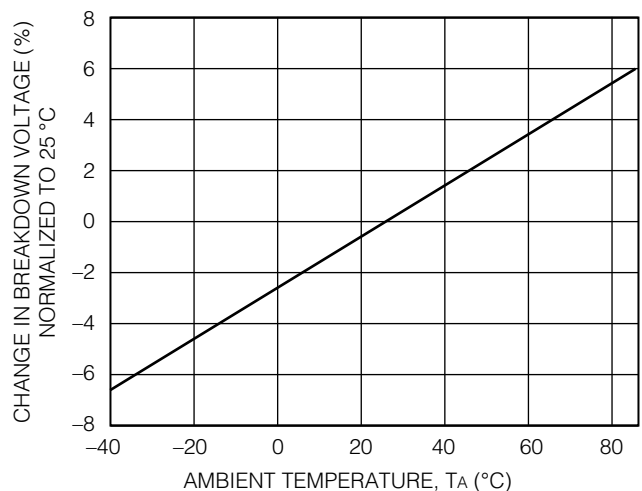

Typical Performance Characteristics (continued)

A. Switch Offset Voltage vs. Temperature

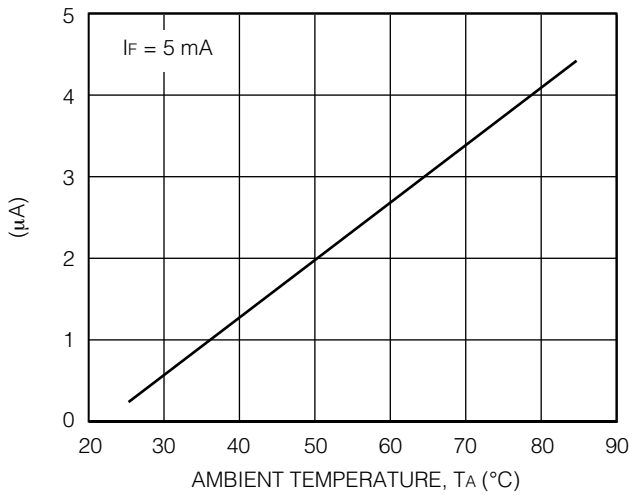

B. LED Offset Voltage vs. LED Current

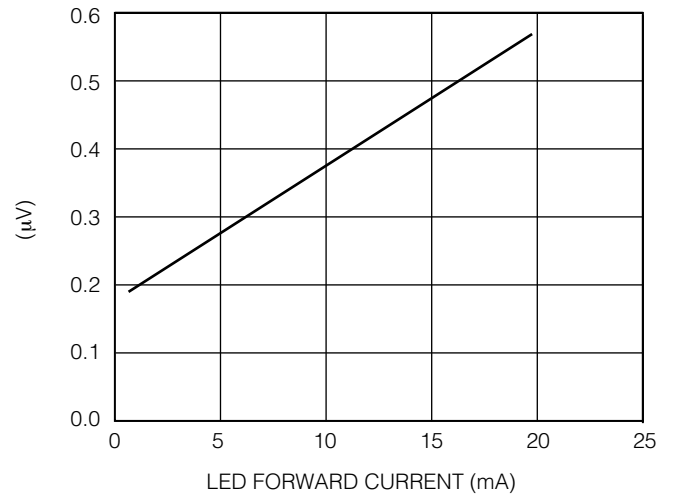

C. Turn-On Time vs. Temperature

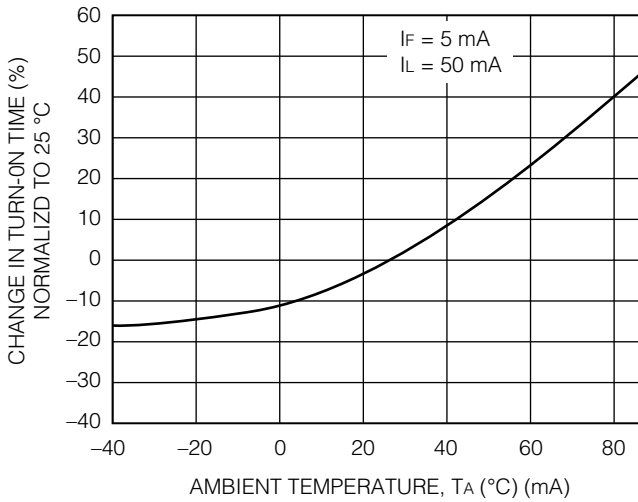

D. Turn-Off Time vs. Temperature

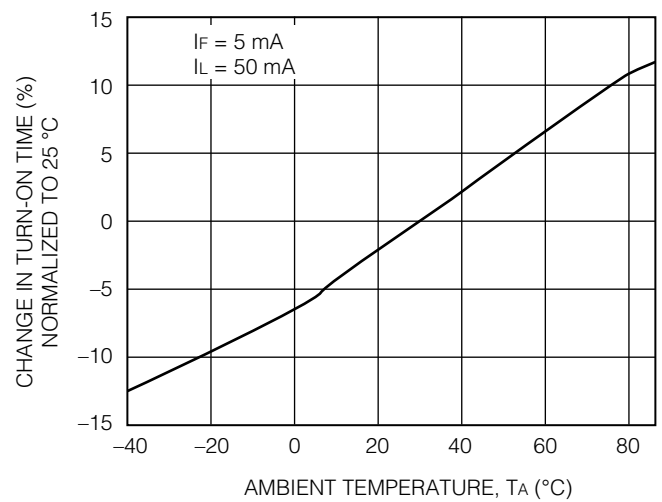

E. Turn-On Time vs. LED Current

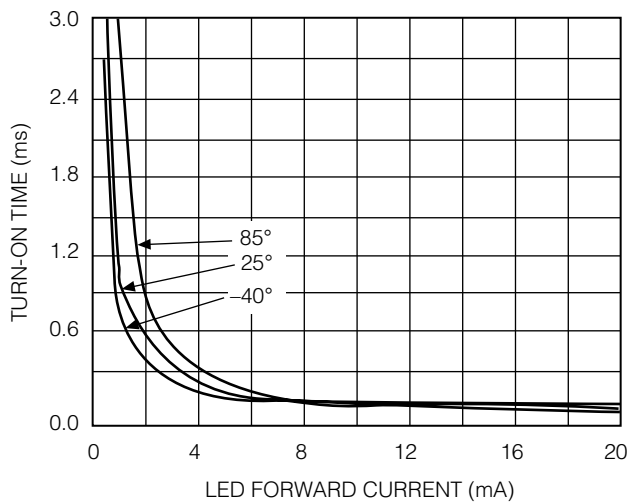

F. Turn-off Time vs. LED Current

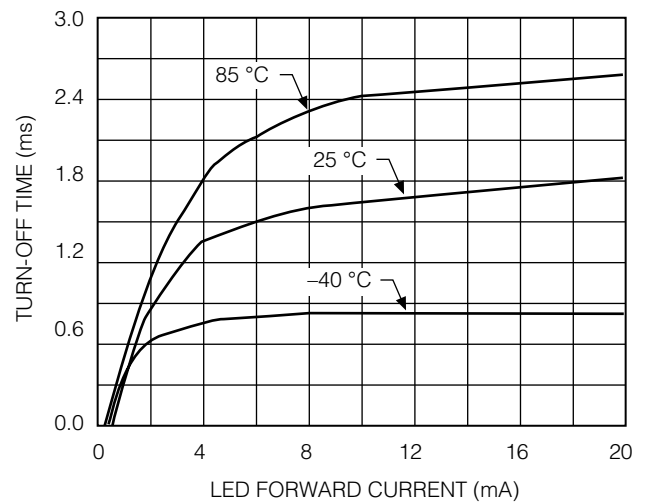

APPLICATIONS

Input Control

The LH1525 low turn-on current SSR has highly sensitive photo-detection circuits that will detect even the most minute currents flowing through the LED. Leakage current must be considered when designing a circuit to turn on and off these relays.

Figure 23 shows a typical logic circuit for providing LED drive current. R1 is the input resistor that limits the amount of current flowing through the LED. For 5 V operation, a 2700 Ω resistor will limit the drive current to about 1.4 mA. Where high-speed actuation is desirable, use a lower value resistor for R1. An additional RC peaking circuit is not required with the LH1525 relay.

R2 is an optional pull-up resistor which pulls the logic level high output (V_{OH}) up toward the V_S potential. The pull-up resistance is set at a high value to minimize the overall current drawn from the V_S . The primary purpose of this resistor is to keep the differential voltage across the LED below its turn-on threshold. LED dropout voltage is graphed vs. temperature in the Typical Performance Characteristics section. When the logic gate is high, leakage current will flow through R2. R2 will draw up to 8 μA before developing a voltage potential which might possibly turn on the LED.

Many applications will operate satisfactorily without a pull-up resistor. In the logic circuit in Figure 1 the only path for current to flow is back into the logic gate. Logic leakage is usually negligible. Each application should be evaluated, however, over the full operating temperature range to make sure that leakage current through the input control LED is kept to a value less than the minimum LED forward current for switch turn-off specification.

Figure 1. Input Control Circuit

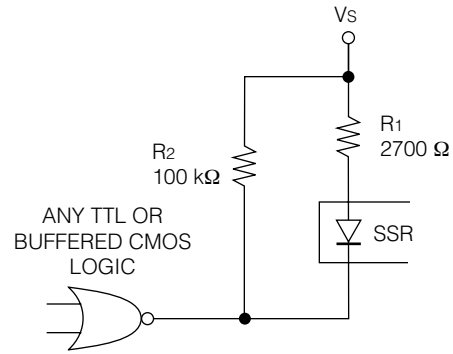

FEATURES

	LH1547	Units
Load Voltage	400	V
Load Current	120	mA
Typical R_{ON}	23	Ω

- 3750 Vrms I/O isolation
- Current-limit protection
- Linear dc operation
- High-surge capability
- Clean, bounce-free switching
- Low power consumption
- High-reliability monolithic receptor
- Surface-mountable

APPLICATIONS

- General telecom switching
- Programmable controllers
- Industrial controls
- Instrumentation
- Peripherals

DESCRIPTION

The LH1547 is a SPST normally open unidirectional relay that can switch ac and dc signals. The relay is constructed using a GaAlAs LED for actuation control and an integrated monolithic die for the switch output. The die, fabricated in a high-voltage dielectrically isolated BICMOS technology, is comprised of a photodiode array, switch control circuitry, and a DMOS switch.

The LH1547 relay is packaged in a 6-pin DIP (LH1547AT1) or in a surface-mount gull wing (LH1547AAB1).

Figure 1. Functional Diagram (LH1547)

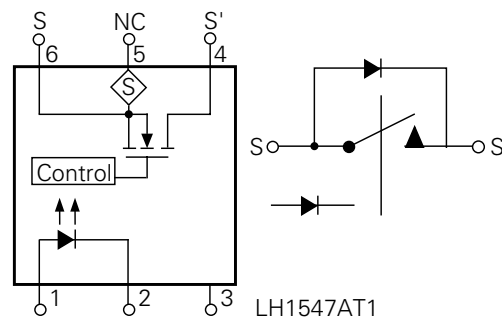

Absolute Maximum Ratings $T_A=25^\circ\text{C}$

Stresses in excess of the Absolute Maximum Ratings can cause permanent damage to the device. These are absolute stress ratings only. Functional operation of the device is not implied at these or any other conditions in

excess of those given in the operational sections of the data sheet. Exposure to Absolute Maximum Ratings for extended periods can adversely affect the device reliability.

Parameter	Symbol	Value	Unit
Ambient Operating Temperature Range	T_A	-40 to +85	$^\circ\text{C}$
Storage Temperature Range	T_{stg}	-40 to +150	$^\circ\text{C}$
Pin Soldering Temperature (t=10 s max.)	T_S	260	$^\circ\text{C}$
Input/Output Isolation Test Voltage (t=1 sec)	V_{ISO}	5300	Vrms
LED Input Ratings:			
Continuous Forward Current	I_F	50	mA
Reverse Voltage ($I_R \leq 10 \mu\text{A}$)	V_R	10	V
Output Operation:			
dc or Peak ac Load Voltage ($I_L \leq 50 \mu\text{A}$)	V_L	400	V
Continuous dc Load Current	I_L	120	mA
Power Dissipation	P_{DISS}	500	mW

Recommended Operating Conditions

Parameter	Symbol	Min	Typ	Max	Unit
LED Forward Current for Switch Turn-on ($T_A=-40^\circ\text{C}$ to $+85^\circ\text{C}$)	I_{FON}	5	—	20	mA

Electrical Characteristics $T_A=25^\circ\text{C}$

Minimum and maximum values are testing requirements. Typical values are characteristics of the device

and are the result of engineering evaluations. Typical values are for information purposes only and are not part of the testing requirements.

Parameter	Symbol	Test Condition	Min	Typ	Max	Unit
LED Forward Current for Switch Turn-on	I_{Fon}	$I_L=90 \text{ mA}$, t=10 ms	—	0.9	2	mA
LED Forward Current for Switch Turn-off	I_{Foff}	$V_L=\pm 350 \text{ V}$	0.1	0.4	—	mA
LED Forward Voltage	V_F	$I_F=10 \text{ mA}$	1.15	1.22	1.45	V
ON-resistance	R_{ON}	$I_F=5 \text{ mA}$	12	23	34	Ω
OFF-resistance	R_{OFF}	$I_F=0 \text{ mA}$, $V_L=\pm 100 \text{ V}$	—	3300	—	G Ω
Current Limit	I_{LMT}	$I_F=5 \text{ mA}$, t=5 ms $V_L=10 \text{ V}$	150	210	270	mA
Output Off-state Leakage Current	—	$I_F=0 \text{ mA}$, $V_L=\pm 100 \text{ V}$ $V_L=\pm 400 \text{ V}$	—	0.03	200	nA μA
Turn-on Time	t_{on}	$I_F=5 \text{ mA}$, $V_L=50 \text{ V}$ $R_L=1 \text{ k}\Omega$	—	1.6	5.0	ms
Turn-off Time	t_{off}	$I_F=5 \text{ mA}$, $V_L=50 \text{ V}$ $R_L=1 \text{ k}\Omega$	—	2.2	5.0	ms

FEATURES

- 1500 Vrms input/output isolation
- High-surge capability
- Low ON-resistance
- Clean, bounce-free switching
- dv/dt typically better than $500 \text{ V}/\mu\text{s}$
- Low power consumption
- Monolithic IC reliability

APPLICATIONS

- Telecom switching
- Transducer driver
- High-voltage testers
- Industrial controls
- Triac predriver
- Isolation switching

DESCRIPTION

The LH1191 High-Voltage, Solid State Relay is a single pole, normally open switch (1 Form A) that can replace electromechanical relays in many applications. The relay features logic-level input control of isolated high-voltage switch outputs. The output is rated at 280 V and can handle loads up to 120 mA. The relay can switch both ac and dc loads and is ideal for audio frequency or dc applications. Typical ON-resistance at 25 mA is 25Ω .

The LH1191 relay consists of a GaAlAs LED that optically couples control signals to a monolithic integrated circuit. Optical coupling provides 1500 Vrms of input/output isolation. The integrated circuit is a dielectrically isolated, high-voltage die comprised of photo-diode arrays, switch control circuitry, and high-voltage DMOS transistor switches.

In operation, the device is exceptionally linear up to 55 mA. Beyond 55 mA, the incremental resistance decreases, thereby minimizing internal power dissipation. Overload currents are clamped at 210 mA by internal current limiting. An extended clamp condition, which increases relay temperature, results in a reduction in clamp current, thereby further reducing internal power dissipation and preserving the relay's integrity. The relay is packaged in a 6-pin, plastic DIP (LH1191AT1) or in a 6-pin, surface-mount, gull-wing configuration (LH1191AAB1).

Absolute Maximum Ratings $T_A=25^\circ\text{C}$

Stresses exceeding the values listed under Absolute Maximum Ratings can cause permanent damage to the device. This is an absolute stress rating only. Functional operation of the device at these or any other conditions

in excess of those indicated in the operational sections of this data sheet is not implied. Exposure to maximum-rating conditions for extended periods of time can adversely affect the device reliability.

Rating	Symbol	Value	Unit
Ambient Operating Temperature Range	T_A	-40 to +85	$^\circ\text{C}$
Storage Temperature Range	T_{stg}	-40 to +100	$^\circ\text{C}$
Pin Soldering Temperature (t=7 s max.)	T_S	270	$^\circ\text{C}$
Input/Output Isolation Voltage (t=60 s min.)	V_{ISO}	1500	Vrms
LED Input Ratings:			
Continuous forward current	I_F	20	mA
Reverse voltage	V_R	10	V
Output Operation:			
dc or peak ac load voltage ($I_L \leq 50 \mu\text{A}$)	V_L	280	V
Continuous dc load current	I_L	135	mA
Power Dissipation	P_{DISS}	500	mW

Recommended Operating Conditions $T_A=25^\circ\text{C}$

(unless otherwise specified)

Parameter	Symbol	Min	Typ	Max	Unit
LED Forward Current for Switch Turn-on ($T_A=-40^\circ\text{C}$ to $+85^\circ\text{C}$)	I_{FON}	6	10	20	mA
Continuous dc Load Current	I_L	—	55	120	mA
ac rms Load Current	—	—	35	85	mA

Electrical Characteristics $T_A=25^\circ\text{C}$

Minimum and maximum values are testing requirements. Typical values are characteristics of the device

and are the result of engineering evaluations. Typical values are for information purposes only and are not part of the testing requirements.

Characteristics	Symbol	Test Condition	Min	Typ	Max	Unit
LED Forward Current for Switch Turn-on	I_{Fon}	I_L (min)=120 mA, $V_L=\pm 7$ V, t=10 ms	—	1.3	2.5	mA
LED Forward Current for Switch Turn-off	I_{Foff}	$I_F=0.2$ mA, $V_L=\pm 250$ V	0.2	1.2	—	mA
LED Forward Voltage	V_F	$I_F=10$ mA	1.15	1.22	1.45	V
ON-resistance	R_{ON}	$I_F=5$ mA, $I_L= \pm 25$ mA	11	25	33	Ω
Current Limit	I_{LMT}	$I_F=5$ mA, $V_L=\pm 7$ V, t=10 ms	140	210	260	mA
Output Off-state Leakage Current	—	$I_F=0$, $V_L=\pm 100$ V	—	0.03	200	nA
Turn-on Time	t_{on}	$I_F=5$ mA, $V_L=+150$ V, $R_L=4$ k Ω	—	1.4	2.0	ms
Turn-off Time	t_{off}	$I_F=5$ mA, $V_L=+150$ V, $R_L=4$ k Ω	—	0.9	2.0	ms
Feedthrough Capacitance Pin 4 to 6	—	$I_F=0$, $V_L=4$ Vp-p, 1 kHz	—	24	—	pF

FEATURES

- 1500 Vrms input/output isolation
- Low ON-resistance
- Clean, bounce-free switching
- dv/dt typically better than 500 V/ μ s
- Low power consumption
- Monolithic IC reliability

APPLICATIONS

- High-voltage testers
- Industrial controls
- Telecom switching
- Triac predriver
- Isolation switching

DESCRIPTION

The LH1085 High-Voltage, Solid State Relay is a single pole, normally open switch (1 Form A) that can replace electromechanical relays in many applications. The relay features logic-level input control of isolated high-voltage switch outputs. The output is rated at 350 V and can handle loads up to 135 mA. The relay can switch both ac and dc loads and is ideal for audio frequency or dc applications. Typical ON-resistance at 25 mA is 30 Ω .

The LH1085 relay consists of a GaAlAs LED that optically couples control signals to a monolithic integrated circuit. Optical coupling provides 1500 Vrms of input/output isolation. The integrated circuit is a dielectrically isolated, high-voltage die comprised of photo-diode arrays, switch control circuitry, and high-voltage DMOS transistor switches.

In operation, the device is exceptionally linear up to 45 mA. Beyond 45 mA, the incremental resistance decreases, thereby minimizing internal power dissipation. Overload currents are clamped at 300 mA by internal current limiting. An extended clamp condition, which increases relay temperature, results in a reduction in clamp current, thereby further reducing internal power dissipation and preserving the relay's integrity. The relay is packaged in a 6-pin, plastic DIP (LH1085AT1) or in a 6-pin, surface-mount, gull-wing configuration (LH1085AAB1).

Absolute Maximum Ratings $T_A=25^\circ\text{C}$

Stresses exceeding the values listed under Absolute Maximum Ratings can cause permanent damage to the device. This is an absolute stress rating only. Functional operation of the device at these or any other conditions

in excess of those indicated in the operational sections of this data sheet is not implied. Exposure to maximum-rating conditions for extended periods of time can adversely affect the device reliability.

Rating	Symbol	Value	Unit
Ambient Operating Temperature Range	T_A	-40 to +85	$^\circ\text{C}$
Storage Temperature Range	T_{stg}	-40 to +100	$^\circ\text{C}$
Pin Soldering Temperature (t=7 s max.)	T_S	270	$^\circ\text{C}$
Input/Output Isolation Voltage (t=60 s min.)	V_{ISO}	1500	Vrms
LED Input Ratings:			
Continuous forward current	I_F	20	mA
Reverse voltage	V_R	10	V
Output Operation:			
dc or peak ac load voltage ($I_L \leq 50 \mu\text{A}$)	V_L	350	V
Continuous dc load current	I_L	135	mA
Peak load current (t=10 ms)	I_P	400	mA
Power Dissipation	P_{DISS}	500	mW

Recommended Operating Conditions $T_A=25^\circ\text{C}$
(unless otherwise specified)

Parameter	Symbol	Min	Typ	Max	Unit
LED Forward Current for Switch Turn-on ($T_A=-40^\circ\text{C}$ to $+85^\circ\text{C}$)	I_{FON}	8	10	20	mA
Continuous dc Load Current	I_L	—	45	135	mA
ac rms Load Current	—	—	30	135	mA

Electrical Characteristics $T_A=25^\circ\text{C}$

Minimum and maximum values are testing requirements. Typical values are characteristics of the device

and are the result of engineering evaluations. Typical values are for information purposes only and are not part of the testing requirements.

Characteristics	Symbol	Test Condition	Min	Typ	Max	Unit
LED Forward Current for Switch Turn-on	I_{Fon}	I_L (min)=150 mA, $V_L=\pm 9\text{ V}$, t=10 ms	—	1.3	2.5	mA
LED Forward Current for Switch Turn-off	I_{Foff}	$I_F=0.2\text{ mA}$, $V_L=\pm 300\text{ V}$	0.2	1.2	—	mA
LED Forward Voltage	V_F	$I_F=10\text{ mA}$	1.15	1.22	1.45	V
ON-resistance	R_{ON}	$I_F=5\text{ mA}$, $I_L=\pm 25\text{ mA}$	20	30	37	Ω
Current Limit	I_{LMT}	$I_F=5\text{ mA}$, $V_L=\pm 9$, t=10 ms	225	300	400	mA
Output Off-state Leakage Current	—	$I_F=0$, $V_L=\pm 100\text{ V}$	—	0.03	200	nA
Turn-on Time	t_{on}	$I_F=5\text{ mA}$, $V_L=+150\text{ V}$, $R_L=4\text{ k}\Omega$	—	1.4	2.0	ms
Turn-off Time	t_{off}	$I_F=5\text{ mA}$, $V_L=+150\text{ V}$, $R_L=4\text{ k}\Omega$	—	0.9	2.0	ms
Feedthrough Capacitance Pin 4 to 6	—	$I_F=0$, $V_L=4\text{ Vp-p}$, 1 kHz	—	24	—	pF