

STM32 microcontroller system memory boot mode

Introduction

The bootloader is stored in the internal boot ROM memory (system memory) of STM32 devices. It is programmed by ST during production. Its main task is to download the application program to the internal Flash memory through one of the available serial peripherals (USART, CAN, USB, I²C, SPI, etc.). A communication protocol is defined for each serial interface, with a compatible command set and sequences.

This document applies to the products listed in [Table 1](#). They are referred as STM32 throughout the document.

Table 1. Applicable products

Type	Part number or product series
Microcontrollers	STM32L0 series: – STM32L051xx, STM32L052xx, STM32L053xx, STM32L062xx, STM32L063xx
	STM32L1 series
	STM32F0 series: – STM32F051xx, STM32F031xx, STM32F042xx, STM32F072xx
	STM32F1 series
	STM32F2 series
	STM32F3 series: – STM32F373xx, STM32F378xx, STM32F358xx, STM32F302xx, STM32F303xx, STM32F318xx, STM32F301xx, STM32F334xx, STM32F328xx
	STM32F4 series: – STM32F405xx, STM32F407xx, STM32F415xx, STM32F417xx, STM32F427xx, STM32F437xx, STM32F429xx, STM32F439xx, STM32F401xx

The main features of the bootloader are the following:

- It uses an embedded serial interface to download the code with a predefined communication protocol
- It transfers and updates the Flash memory code, the data, and the vector table sections

This application note presents the general concept of the bootloader. It describes the supported peripherals and hardware requirements to be considered when using the bootloader of STM32 devices. However the specifications of the low-level communication protocol for each supported serial peripheral are documented in separate documents. For specifications of the USART protocol used in the bootloader, refer to AN3155. For the specification of the CAN protocol used in the bootloader, refer to AN3154. For the specification of the DFU (USB device) protocol used in the bootloader, refer to AN3156. For the specification of the I²C protocol used in the bootloader, refer to AN4221. For the specification of the SPI protocol used in the bootloader, refer to AN4286.

Contents

1	Related documents	10
2	Glossary	10
3	General bootloader description	13
3.1	Bootloader activation	13
3.2	Bootloader identification	14
3.3	Hardware connection requirements	17
3.4	Bootloader Memory Management	19
4	STM32F10xxx devices bootloader	21
4.1	Bootloader configuration	21
4.2	Bootloader selection	22
4.3	Bootloader version	22
5	STM32F105xx/107xx devices bootloader	23
5.1	Bootloader configuration	23
5.2	Bootloader selection	25
5.3	Bootloader version	26
5.3.1	How to identify STM32F105xx/107xx bootloader versions	26
5.3.2	Bootloader unavailability on STM32F105xx/STM32F107xx devices with a date code below 937	27
5.3.3	USART bootloader Get-Version command returns 0x20 instead of 0x22	28
5.3.4	PA9 excessive power consumption when USB cable is plugged in bootloader V2.0	28
6	STM32F10xxx XL-density devices bootloader	29
6.1	Bootloader configuration	29
6.2	Bootloader selection	30
6.3	Bootloader version	30
7	STM32L1xxx6(8/B) devices bootloader	31
7.1	Bootloader configuration	31

7.2	Bootloader selection	32
7.3	Bootloader version	32
8	STM32L1xxxC devices bootloader	33
8.1	Bootloader configuration	33
8.2	Bootloader selection	35
8.3	Bootloader version	35
9	STM32L1xxxD devices bootloader	36
9.1	Bootloader configuration	36
9.2	Bootloader selection	38
9.3	Bootloader version	39
10	STM32F2xxxx devices bootloader	40
10.1	Bootloader V2.x	40
10.1.1	Bootloader configuration	40
10.1.2	Bootloader selection	41
10.1.3	Bootloader version	42
10.2	Bootloader V3.x	43
10.2.1	Bootloader configuration	43
10.2.2	Bootloader selection	45
10.2.3	Bootloader version	46
11	STM32F40xxx/41xxx devices bootloader	47
11.1	Bootloader V3.x	47
11.1.1	Bootloader configuration	47
11.1.2	Bootloader selection	49
11.1.3	Bootloader version	50
11.2	Bootloader V9.x	51
11.2.1	Bootloader configuration	51
11.2.2	Bootloader selection	55
11.2.3	Bootloader version	56
12	STM32F051xx devices bootloader	57
12.1	Bootloader configuration	57
12.2	Bootloader selection	58

12.3	Bootloader version	58
13	STM32F031xx devices bootloader	59
13.1	Bootloader configuration	59
13.2	Bootloader selection	60
13.3	Bootloader version	60
14	STM32F373xx devices bootloader	61
14.1	Bootloader configuration	61
14.2	Bootloader selection	63
14.3	Bootloader version	63
15	STM32F302xB(C)/303xB(C) devices bootloader	64
15.1	Bootloader configuration	64
15.2	Bootloader selection	66
15.3	Bootloader version	66
16	STM32F378xx devices bootloader	67
16.1	Bootloader configuration	67
16.2	Bootloader selection	68
16.3	Bootloader version	68
17	STM32F358xx devices bootloader	69
17.1	Bootloader configuration	69
17.2	Bootloader selection	70
17.3	Bootloader version	70
18	STM32F427xx/437xx devices bootloader	71
18.1	Bootloader configuration	71
18.2	Bootloader selection	73
18.3	Bootloader version	74
19	STM32F429xx/439xx devices bootloader	75
19.1	Bootloader V7.x	75
19.1.1	Bootloader configuration	75
19.1.2	Bootloader selection	77

	19.1.3	Bootloader version	80
	19.2	Bootloader V9.x	80
	19.2.1	Bootloader configuration	80
	19.2.2	Bootloader selection	85
	19.2.3	Bootloader version	87
20		STM32F042xx devices bootloader	88
	20.1	Bootloader configuration	88
	20.2	Bootloader selection	89
	20.3	Bootloader version	90
21		STM32F072xx devices bootloader	91
	21.1	Bootloader configuration	91
	21.2	Bootloader selection	92
	21.3	Bootloader version	93
22		STM32F301xx/302x4(6/8) devices bootloader	94
	22.1	Bootloader configuration	94
	22.2	Bootloader selection	96
	22.3	Bootloader version	96
23		STM32F318xx devices bootloader	97
	23.1	Bootloader configuration	97
	23.2	Bootloader selection	98
	23.3	Bootloader version	99
24		STM32F303x4(6/8)/334xx/328xx devices bootloader	100
	24.1	Bootloader configuration	100
	24.2	Bootloader selection	101
	24.3	Bootloader version	101
25		STM32F401xB(C) devices bootloader	102
	25.1	Bootloader configuration	102
	25.2	Bootloader selection	106
	25.3	Bootloader version	107

26	STM32F401xD(E) devices bootloader	108
26.1	Bootloader configuration	108
26.2	Bootloader selection	112
26.3	Bootloader version	113
27	STM32L1xxx6(8/B)A devices bootloader	114
27.1	Bootloader configuration	114
27.2	Bootloader selection	115
27.3	Bootloader version	115
28	STM32L1xxxE devices bootloader	116
28.1	Bootloader configuration	116
28.2	Bootloader selection	118
28.3	Bootloader version	119
29	STM32L05xxx/06xxx devices bootloader	120
29.1	Bootloader configuration	120
29.2	Bootloader selection	122
29.3	Bootloader version	122
30	Device-dependent bootloader parameters	123
31	Bootloader timing	125
31.1	Bootloader Startup timing	125
31.2	USART connection timing	127
31.3	USB connection timing	128
31.4	I2C connection timing	130
31.5	SPI connection timing	131
32	Revision history	132

List of tables

Table 1.	Applicable products	1
Table 2.	Bootloader activation patterns	13
Table 3.	Embedded bootloaders	14
Table 4.	STM32 F2 and F4 Voltage Range configuration using bootloader	20
Table 5.	Supported memory area by Write, Read, Erase and Go Commands	20
Table 6.	STM32F10xxx configuration in System memory boot mode	21
Table 7.	STM32F10xxx bootloader versions	22
Table 8.	STM32F105xx/107xx configuration in System memory boot mode	23
Table 9.	STM32F105xx/107xx bootloader versions	26
Table 10.	STM32F10xxx XL-density configuration in System memory boot mode	29
Table 11.	XL-density bootloader versions	30
Table 12.	STM32L1xxx6(8/B) configuration in System memory boot mode	31
Table 13.	STM32L1xxx6(8/B) bootloader versions	32
Table 14.	STM32L1xxxC configuration in System memory boot mode	33
Table 15.	STM32L1xxxC bootloader versions	35
Table 16.	STM32L1xxxD configuration in System memory boot mode	36
Table 17.	STM32L1xxxD bootloader versions	39
Table 18.	STM32F2xxxx configuration in System memory boot mode	40
Table 19.	STM32F2xxxx bootloader V2.x versions	42
Table 20.	STM32F2xxxx configuration in System memory boot mode	43
Table 21.	STM32F2xxxx bootloader V3.x versions	46
Table 22.	STM32F40xxx/41xxx configuration in System memory boot mode	47
Table 23.	STM32F40xxx/41xxx bootloader V3.x version	50
Table 24.	STM32F40xxx/41xxx configuration in System memory boot mode	51
Table 25.	STM32F40xxx/41xxx bootloader V9.x version	56
Table 26.	STM32F051xx configuration in System memory boot mode	57
Table 27.	STM32F051xx bootloader versions	58
Table 28.	STM32F031xx configuration in System memory boot mode	59
Table 29.	STM32F031xx bootloader versions	60
Table 30.	STM32F373xx configuration in System memory boot mode	61
Table 31.	STM32F373xx bootloader versions	63
Table 32.	STM32F302xB(C)/303xB(C) configuration in System memory boot mode	64
Table 33.	STM32F302xB(C)/303xB(C) bootloader versions	66
Table 34.	STM32F378xx configuration in System memory boot mode	67
Table 35.	STM32F378xx bootloader versions	68
Table 36.	STM32F358xx configuration in System memory boot mode	69
Table 37.	STM32F358xx bootloader versions	70
Table 38.	STM32F427xx/437xx configuration in System memory boot mode	71
Table 39.	STM32F427xx/437xx bootloader version	74
Table 40.	STM32F429xx/439xx configuration in System memory boot mode	75
Table 41.	STM32F429xx/439xx bootloader V7.x version	80
Table 42.	STM32F429xx/439xx configuration in System memory boot mode	81
Table 43.	STM32F429xx/439xx bootloader V9.x version	87
Table 44.	STM32F042xx configuration in System memory boot mode	88
Table 45.	STM32F042xx bootloader versions	90
Table 46.	STM32F072xx configuration in System memory boot mode	91
Table 47.	STM32F072xx bootloader versions	93
Table 48.	STM32F301xx/302x4(6/8) configuration in System memory boot mode	94

Table 49.	STM32F301xx/302x4(6/8) bootloader versions	96
Table 50.	STM32F318xx configuration in System memory boot mode	97
Table 51.	STM32F318xx bootloader versions	99
Table 52.	STM32F303x4(6/8)/334xx/328xx configuration in System memory boot mode	100
Table 53.	STM32F303x4(6/8)/334xx/328xx bootloader versions	101
Table 54.	STM32F401xB(C) configuration in System memory boot mode.	102
Table 55.	STM32F401xB(C) bootloader version	107
Table 56.	STM32F401xD(E) configuration in System memory boot mode.	108
Table 57.	STM32F401xD(E) bootloader version	113
Table 58.	STM32L1xxx6(8/B)A configuration in System memory boot mode	114
Table 59.	STM32L1xxx6(8/B)A bootloader versions	115
Table 60.	STM32L1xxxE configuration in System memory boot mode	116
Table 61.	STM32L1xxxE bootloader versions	119
Table 62.	STM32L05xxx/06xxx configuration in System memory boot mode	120
Table 63.	STM32L05xxx/06xxx bootloader versions	122
Table 64.	Bootloader device-dependent parameters	123
Table 65.	Bootloader startup timings of STM32 devices	125
Table 66.	USART bootloader minimum timings of STM32 devices	127
Table 67.	USB bootloader minimum timings of STM32 devices.	129
Table 68.	I2C bootloader minimum timings of STM32 devices.	130
Table 69.	SPI bootloader minimum timings of STM32 devices	131
Table 70.	Document revision history	132

List of figures

Figure 1.	USART Connection	17
Figure 2.	USB Connection	17
Figure 3.	I2C Connection	18
Figure 4.	SPI Connection	18
Figure 5.	CAN Connection	19
Figure 6.	Bootloader for STM32F10xxx with USART1	22
Figure 7.	Bootloader selection for STM32F105xx/107xx devices	25
Figure 8.	Bootloader selection for STM32F10xxx XL-density devices	30
Figure 9.	Bootloader selection for STM32L1xxx6(8/B) devices	32
Figure 10.	Bootloader selection for STM32L1xxxC devices	35
Figure 11.	Bootloader selection for STM32L1xxxD devices	38
Figure 12.	Bootloader V2.x selection for STM32F2xxxx devices	41
Figure 13.	Bootloader V3.x selection for STM32F2xxxx devices	45
Figure 14.	Bootloader V3.x selection for STM32F40xxx/41xxx devices	49
Figure 15.	Bootloader V9.x selection for STM32F40xxx/41xxx	55
Figure 16.	Bootloader selection for STM32F051xx devices	58
Figure 17.	Bootloader selection for STM32F031xx devices	60
Figure 18.	Bootloader selection for STM32F373xx devices	63
Figure 19.	Bootloader selection for STM32F302xB(C)/303xB(C) devices	66
Figure 20.	Bootloader selection for STM32F378xx devices	68
Figure 21.	Bootloader selection for STM32F358xx devices	70
Figure 22.	Bootloader selection for STM32F427xx/437xx devices	73
Figure 23.	Dual Bank Boot Implementation for STM32F429xx/439xx Bootloader V7.x	78
Figure 24.	Bootloader V7.x selection for STM32F429xx/439xx	79
Figure 25.	Dual Bank Boot Implementation for STM32F429xx/439xx Bootloader V9.x	85
Figure 26.	Bootloader V9.x selection for STM32F429xx/439xx	86
Figure 27.	Bootloader selection for STM32F042xx	89
Figure 28.	Bootloader selection for STM32F072xx	92
Figure 29.	Bootloader selection for STM32F301xx/302x4(6/8)	96
Figure 30.	Bootloader selection for STM32F318xx	98
Figure 31.	Bootloader selection for STM32F303x4(6/8)/334xx/328xx	101
Figure 32.	Bootloader selection for STM32F401xB(C)	106
Figure 33.	Bootloader selection for STM32F401xD(E)	112
Figure 34.	Bootloader selection for STM32L1xxx6(8/B)A devices	115
Figure 35.	Bootloader selection for STM32L1xxxE devices	118
Figure 36.	Bootloader selection for STM32L05xxx/06xxx	122
Figure 37.	Bootloader Startup timing description	125
Figure 38.	USART connection timing description	127
Figure 39.	USB connection timing description	129
Figure 40.	I2C connection timing description	130
Figure 41.	SPI connection timing description	131

1 Related documents

For each supported product (listed in [Table 1](#)), please refer to the following documents available from <http://www.st.com>:

- Datasheet or databrief
- Reference manual

2 Glossary

F0 Series:

STM32F051xx is used to refer to STM32F051x4, STM32F051x6 and STM32F051x8 devices.

STM32F031xx is used to refer to STM32F031x4 and STM32F031x6 devices.

STM32F042xx is used to refer to STM32F042x4 and STM32F042x6 devices.

STM32F072xx is used to refer to STM32F072x8 and STM32F072xB devices.

F1 Series:

STM32F10xxx is used to refer to Low-density, Medium-density, High-density, Low-density value line, Medium-density value line and High-density value line devices:

Low-density devices are STM32F101xx, STM32F102xx and STM32F103xx microcontrollers where the Flash memory density ranges between 16 and 32 Kbytes.

Medium-density devices are STM32F101xx, STM32F102xx and STM32F103xx microcontrollers where the Flash memory density ranges between 64 and 128 Kbytes.

High-density devices are STM32F101xx and STM32F103xx microcontrollers where the Flash memory density ranges between 256 and 512 Kbytes.

Low-density value line devices are STM32F100xx microcontrollers where the Flash memory density ranges between 16 and 32 Kbytes.

Medium-density value line devices are STM32F100xx microcontrollers where the Flash memory density ranges between 64 and 128 Kbytes.

High-density value line devices are STM32F100xx microcontrollers where the Flash memory density ranges between 256 and 512 Kbytes.

STM32F105xx/107xx is used to refer to STM32F105xx and STM32F107xx devices.

STM32F10xxx XL-density is used to refer to STM32F101xx and STM32F103xx devices where the Flash memory density ranges between 768 Kbytes and 1 Mbyte.

F2 Series:

STM32F2xxxx is used to refer to STM32F215xx, STM32F205xx, STM32F207xx and STM32F217xx devices.

F3 Series:

STM32F373xx is used to refer to STM32F373x8, STM32F373xB and STM32F373xC devices.

STM32F302xB(C)/303xB(C) is used to refer to STM32F302xB, STM32F302xC, STM32F303xB and STM32F303xC devices.

STM32F378xx is used to refer to STM32F378xC devices.

STM32F358xx is used to refer to STM32F358xC devices.

STM32F301xx/302x4(6/8) is used to refer to STM32F301x4, STM32F301x6, STM32F301x8, STM32F302x4, STM32F302x6 and STM32F302x8 devices.

STM32F318xx is used to refer to STM32F318xC devices.

STM32F303x4(6/8)/334xx/328xx is used to refer to STM32F303x4, STM32F303x6, STM32F303x8, STM32F334x4, STM32F334x6, STM32F334x8, and STM32F328x8 devices.

F4 Series:

STM32F40xxx/41xxx is used to refer to STM32F405xx, STM32F407xx, STM32F415xx and SMT32F417xx devices.

STM32F427xx/437xx is used to refer to STM32F427xx and STM32F437xx devices.

STM32F429xx/439xx is used to refer to STM32F429xx and STM32F439xx devices.

STM32F401xB(C) is used to refer to STM32F401xB and STM32F401xC devices.

STM32F401xD(E) is used to refer to STM32F401xD and STM32F401xE devices.

L0 Series:

STM32L05xxx/06xxx is used to refer to STM32L051xx, STM32L052xx, STM32L053xx, STM32L062xx and STM32L063xx ultralow power devices.

L1 Series:

STM32L1xxx6(8/B) is used to refer to STM32L1xxV6T6, STM32L1xxV6H6, STM32L1xxR6T6, STM32L1xxR6H6, STM32L1xxC6T6, STM32L1xxC6H6, STM32L1xxV8T6, STM32L1xxV8H6, STM32L1xxR8T6, STM32L1xxR8H6, STM32L1xxC8T6, STM32L1xxC8H6, STM32L1xxVBT6, STM32L1xxVBH6, STM32L1xxRBT6, STM32L1xxRBH6, STM32L1xxCBT6 and STM32L1xxCBH6 ultralow power devices.

STM32L1xxx6(8/B)A is used to refer to STM32L1xxV6T6-A, STM32L1xxV6H6-A, STM32L1xxR6T6-A, STM32L1xxR6H6-A, STM32L1xxC6T6-A, STM32L1xxC6H6-A, STM32L1xxV8T6-A, STM32L1xxV8H6-A, STM32L1xxR8T6-A, STM32L1xxR8H6-A, STM32L1xxC8T6-A, STM32L1xxC8H6-A, STM32L1xxVBT6-A, STM32L1xxVBH6-A, STM32L1xxRBT6-A, STM32L1xxRBH6-A, STM32L1xxCBT6-A and STM32L1xxCBH6-A ultralow power devices.

STM32L1xxxC is used to refer to STM32L1xxVCT6, STM32L1xxVCH6, STM32L1xxRCT6, STM32L1xxUCY6, STM32L1xxCCT6 and STM32L1xxCCU6 ultralow power devices.

STM32L1xxxD is used to refer to STM32L1xxZDT6, STM32L1xxQDH6, STM32L1xxVDT6, STM32L1xxRDY6, STM32L1xxRDT6, STM32L1xxZCT6, STM32L1xxQCH6, STM32L1xxRCY6, STM32L1xxVCT6-A and STM32L1xxRCT6-A ultralow power devices.

STM32L1xxxE is used to refer to STM32L1xxZET6, STM32L1xxQEH6, STM32L1xxVET6, STM32L1xxVEY6, and STM32L1xxRET6 ultralow power devices.

Note: *BL_USART_Loop* refers to the *USART Bootloader* execution loop.
 BL_CAN_Loop refers to the *CAN Bootloader* execution loop.
 BL_I2C_Loop refers to the *I2C Bootloader* execution loop.
 BL_SPI_Loop refers to the *SPI Bootloader* execution loop.

3 General bootloader description

3.1 Bootloader activation

The bootloader is activated by applying one of these pattern:

Table 2. Bootloader activation patterns

Condition	Condition
Pattern1	Boot0(Pin) = 1 and Boot1(Pin) = 0
Pattern2	Boot0(Pin) = 1 and nBoot1(bit) = 1
Pattern3	Boot0 (Pin)= 1, Boot1(Pin) = 0 and BFB2 (bit) = 1
	Boot0(Pin) = 0, BFB2 (bit) = 0 and both banks don't contain valid code
	Boot0(Pin) = 1, Boot1(Pin) = 0, BFB2 (bit) = 0 and both banks don't contain valid code
Pattern4	Boot0 (Pin)= 1, Boot1(Pin) = 0 and BFB2 (bit) = 1
	Boot0(Pin) = 0, BFB2 (bit) = 0 and both banks don't contain valid code
	Boot0(Pin) = 1, Boot1(Pin) = 0 and BFB2 (bit) = 0
Pattern5	Boot0 (Pin)= 1, Boot1(Pin) = 0 and BFB2 (bit) = 0
	Boot0(Pin) = 0, BFB2 (bit) = 1 and both banks don't contain valid code
	Boot0(Pin) = 1, Boot1(Pin) = 0 and BFB2 (bit) = 1
Pattern6	Boot0(Pin) = 1, nBoot1(bit) = 1 and nBoot0_SW(bit) = 1
	nBoot0(bit) = 0, nBoot1(bit) = 1 and nBoot0_SW(bit) = 0
	Boot0(Pin) = 0, nBoot0_SW(bit) = 1 and main flash empty

Note: The bootloader activation procedure is not the same for all STM32 products. In each STM32 product bootloader section we specify which pattern is used to execute bootloader.

In addition to patterns described below, user can execute bootloader by performing a jump to system memory from user code. Befor jumping to Bootloader user must :

- Disable all peripheral clocks
- Disable used PLL
- Disable interrupts
- Clear pending interrupts

System memory boot mode can be exited by getting out from bootloader activation condition and generating hardware reset or using Go command to execute user code.

Note: if you choose to execute the Go command, the peripheral registers used by the bootloader are not initialized to their default reset values before jumping to the user application. They should be reconfigured in the user application if they are used. So, if the IWDG is being used in the application, the IWDG prescaler value has to be adapted to meet the requirements of the application (since the prescaler was set to its maximum value).

3.2 Bootloader identification

Depending on the STM32 device used, the bootloader may support one or more embedded serial peripherals used to download the code to the internal Flash memory. The bootloader identifier (ID) provides information about the supported serial peripherals.

For a given STM32 device, the bootloader is identified by means of the:

1. **Bootloader (protocol) version:** version of the serial peripheral (USART, CAN, USB, etc.) communication protocol used in the bootloader. This version can be retrieved using the bootloader Get Version command.
2. **Bootloader identifier (ID):** version of the STM32 device bootloader, coded on one byte in the **0xXY** format, where:
 - **X** specifies the embedded serial peripheral(s) used by the device bootloader:
 - X = 1: one USART is used
 - X = 2: two USARTs are used
 - X = 3: USARTs, CAN and DFU are used
 - X = 4: USARTs and DFU are used
 - X = 5: USARTs and I²C are used
 - X = 6: I²C is used
 - X = 7: USARTs, one CAN, DFU and I²C are used
 - X = 8: I²C and SPI are used
 - X = 9: USARTs, CAN, DFU, I²C and SPI are used
 - X = 10: USARTs, DFU and I²C are used
 - X = 11: USARTs, I²C and SPI are used
 - X = 12: USARTs and SPI are used
 - X = 13: USARTs, DFU, I²C and SPI are used
 - **Y** specifies the device bootloader version
 Let us take the example of a bootloader ID equal to 0x10. This means that it is the first version of the device bootloader that uses only one USART.
 The bootloader ID is programmed in the last byte address - 1 of the device system memory and can be read by using the bootloader “Read memory” command or by direct access to the system memory via JTAG/SWD.

The table below provides identification information about the bootloader embedded in STM32 devices.

Table 3. Embedded bootloaders

STM32 series	Device	Supported serial peripherals	Bootloader ID		Bootloader (protocol) version
			ID	Memory location	
F0	STM32F051xx	USART1/USART2	0x21	0x1FFFF7A6	USART (V3.1)
	STM32F031xx	USART1	0x10	0x1FFFF7A6	USART (V3.1)
	STM32F042xx	USART1/USART2/ I2C1/ DFU (USB Device FS)	0xA0	0x1FFFF6A6	USART (V3.1) DFU (V2.2) I2C (V1.0)
	STM32F072xx	USART1/USART2/ I2C1/ DFU (USB Device FS)	0xA1	0x1FFFF6A6	USART (V3.1) DFU (V2.2) I2C (V1.0)

Table 3. Embedded bootloaders (continued)

STM32 series	Device		Supported serial peripherals	Bootloader ID		Bootloader (protocol) version
				ID	Memory location	
F1	STM32F10xxx	Low-density	USART1	NA	NA	USART (V2.2)
		Medium-density	USART1	NA	NA	USART (V2.2)
		High-density	USART1	NA	NA	USART (V2.2)
		Medium-density value line	USART1	0x10	0x1FFFF7D6	USART (V2.2)
		High-density value line	USART1	0x10	0x1FFFF7D6	USART (V2.2)
	STM32F105xx/107xx	USART1 / USART2 (remapped) / CAN2 (remapped) / DFU (USB Device)	NA	NA	USART (V2.2 ⁽¹⁾) CAN (V2.0) DFU(V2.2)	
	STM32F10xxx XL-density	USART1/USART2 (remapped)	0x21	0x1FFFF7D6	USART (V3.0)	
F2	STM32F2xxxx	USART1/USART3	0x20	0x1FFF77DE	USART (V3.0)	
		USART1/USART3/ CAN2/ DFU (USB Device FS)	0x33	0x1FFF77DE	USART (V3.1) CAN (V2.0) DFU (V2.2)	
F3	STM32F373xx	USART1/USART2/ DFU (USB Device FS)	0x41	0x1FFFF7A6	USART (V3.1) DFU (V2.2)	
	STM32F378xx	USART1/USART2/ I2C1	0x50	0x1FFFF7A6	USART (V3.1) I2C (V1.0)	
	STM32F302xB(C)/303xB(C)	USART1/USART2/ DFU (USB Device FS)	0x41	0x1FFFF796	USART (V3.1) DFU (V2.2)	
	STM32F358xx	USART1/USART2/ I2C1	0x50	0x1FFFF796	USART (V3.1) I2C (V1.0)	
	STM32F301xx/302x4(6/8)	USART1/USART2/ DFU (USB Device FS)	0x40	0x1FFFF796	USART (V3.1) DFU (V2.2)	
	STM32F318xx	USART1/USART2/ I2C1/ I2C3	0x50	0x1FFFF796	USART (V3.1) I2C (V1.0)	
	STM32F303x4(6/8)/334xx/328xx	USART1/USART2/ I2C1	0x50	0x1FFFF796	USART (V3.1) I2C (V1.0)	

Table 3. Embedded bootloaders (continued)

STM32 series	Device	Supported serial peripherals	Bootloader ID		Bootloader (protocol) version
			ID	Memory location	
F4	STM32F40xx/41xxx	USART1/USART3/ CAN2/ DFU (USB Device FS)	0x31	0x1FFF77DE	USART (V3.1) CAN (V2.0) DFU (V2.2)
		USART1/USART3/ CAN2 / DFU (USB Device FS) /I2C1/I2C2/I2C3/SPI1/ SPI2	0x90	0x1FFF77DE	USART (V3.1) CAN (V2.0) DFU (V2.2) SPI(V1.1) I2C (V1.0)
	STM32F427xx/437xx	USART1/USART3/ CAN2 /DFU (USB Device FS)	0x30	0x1FFF76DE	USART (V3.1) CAN (V2.0) DFU (V2.2)
	STM32F429xx/439xx	USART1/USART3/ CAN2 /DFU (USB Device FS) / I2C1/I2C2/I2C3	0x70	0x1FFF76DE	USART (V3.1) CAN (V2.0) DFU (V2.2) I2C (V1.0)
		USART1/USART3/ CAN2 / DFU (USB Device FS) / I2C1/I2C2/I2C3/SPI1/ SPI2/ SPI4	0x90	0x1FFF76DE	USART (V3.1) CAN (V2.0) DFU (V2.2) SPI(V1.1) I2C (V1.0)
	STM32F401xB(C)	USART1/USART2/ DFU (USB Device FS)/ I2C1/I2C2/I2C3/ SPI1/SPI2/ SPI3	0xD1	0x1FFF76DE	USART (V3.1) DFU (V2.2) SPI(V1.1) I2C (V1.0)
STM32F401xD(E)	USART1/USART2/ DFU (USB Device FS)/ I2C1/I2C2/I2C3/ SPI1/SPI2/ SPI3	0xD1	0x1FFF76DE	USART (V3.1) DFU (V2.2) SPI(V1.1) I2C (V1.1)	
L0	STM32L05xxx/06xxx	USART1/USART2/SPI 1/ SPI2	0xC0	0x1FF00FFE	USART (V3.1) SPI (V1.1)
L1	STM32L1xxx6(8/B)	USART1/USART2	0x20	0x1FF00FFE	USART (V3.0)
	STM32L1xxx6(8/B)A	USART1/USART2	0x20	0x1FF00FFE	USART (V3.1)
	STM32L1xxxC	USART1/USART2/ DFU (USB Device FS)	0x40	0x1FF01FFE	USART (V3.1) DFU (V2.2)
	STM32L1xxxD	USART1/USART2/ DFU (USB Device FS)	0x45	0x1FF01FFE	USART (V3.1) DFU (V2.2)
	STM32L1xxxE	USART1/USART2/ DFU (USB Device FS)	0x40	0x1FF01FFE	USART (V3.1) DFU (V2.2)

1. For connectivity line devices, the USART bootloader returns V2.0 instead of V2.2 for the protocol version. For more details please refer to the "STM32F105xx and STM32F107xx revision Z" errata sheet available from <http://www.st.com>.

3.3 Hardware connection requirements

To use the USART bootloader, the host has to be connected to the (RX) and (TX) pins of the desired USARTx interface via a serial cable.

Figure 1. USART Connection

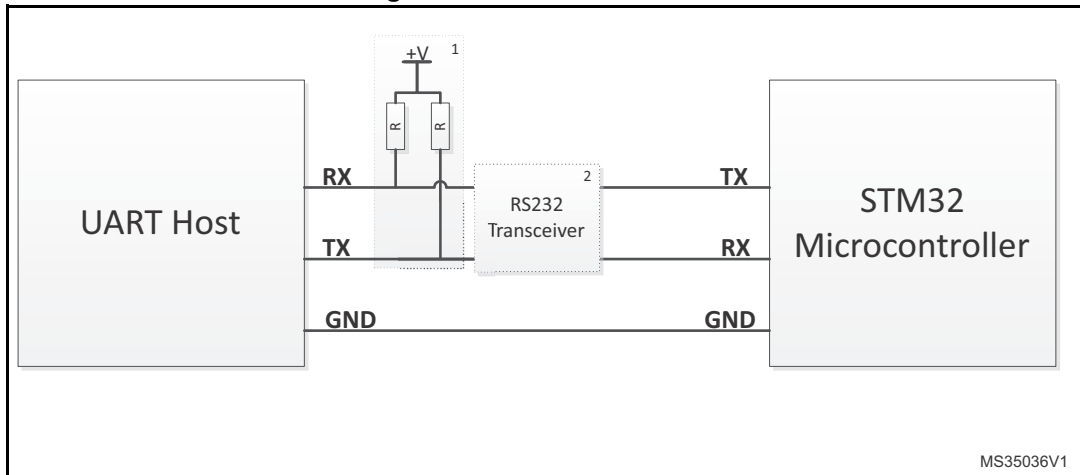

1. A Pull-UP resistor should be added, if pull-up resistor are not connected in host side.
2. An RS232 transceiver must be connected to adapt voltage level (3.3V - 12V) between STM32 device and host.

Note: +V typically 3.3 V and R value typically 100KOhm. This value depend on the application and the used hardware.

To use the DFU, connect the microcontroller's USB interface to a USB host (i.e. PC).

Figure 2. USB Connection

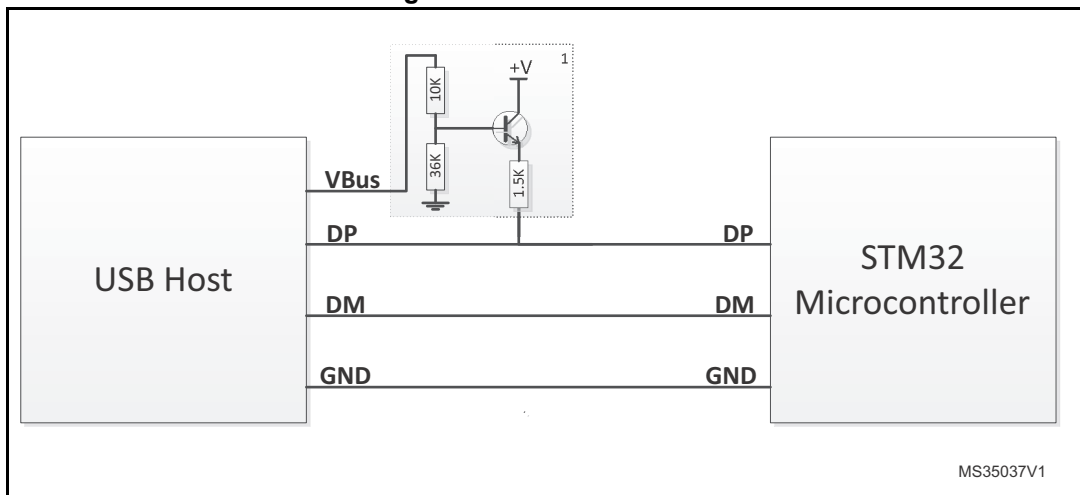

1. This additional circuit permit to connect a Pull-Up resistor to (DP) pin using VBus when needed. Refer to product section (Table which describe STM32 Configuration in systeme memory boot mode) to know if an external pull-up resistor must be connected to (DP) pin.

Note: +V typically 3.3 V. This value depend on the application and the used hardware.

To use the I2C bootloader, connect the host (master) and the desired I2Cx interface (slave) together via the data (SDA) and clock (SCL) pins. An 1.8 Kohm pull-up resistor has to be connected to both (SDA) and (SCL) lines.

Figure 3. I2C Connection

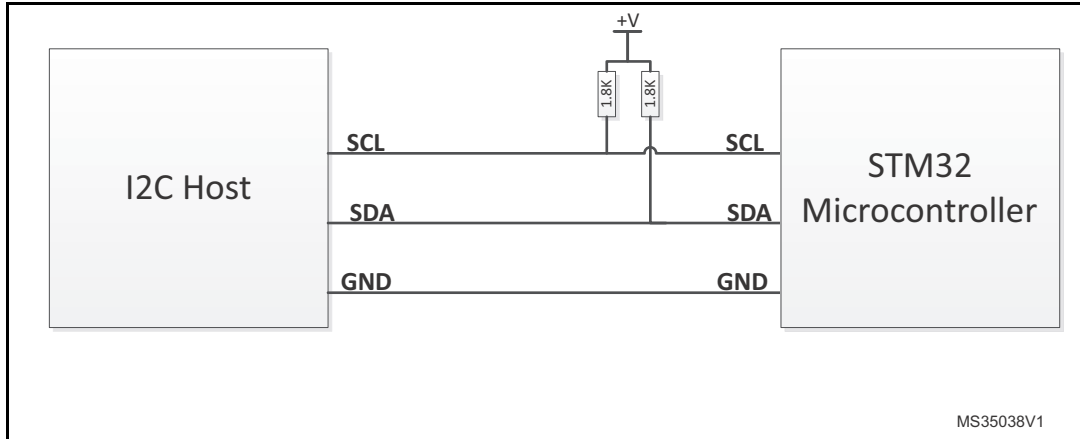

Note: +V typically 3.3 V. This value depends on the application and the used hardware.

To use the SPI bootloader, connect the host (master) and the desired SPIx interface (slave) together via the (MOSI), (MISO) and (SCK) pins. (NSS) pin must be connected to (GND). A pull-down resistor should be connected to (SCK) line.

Figure 4. SPI Connection

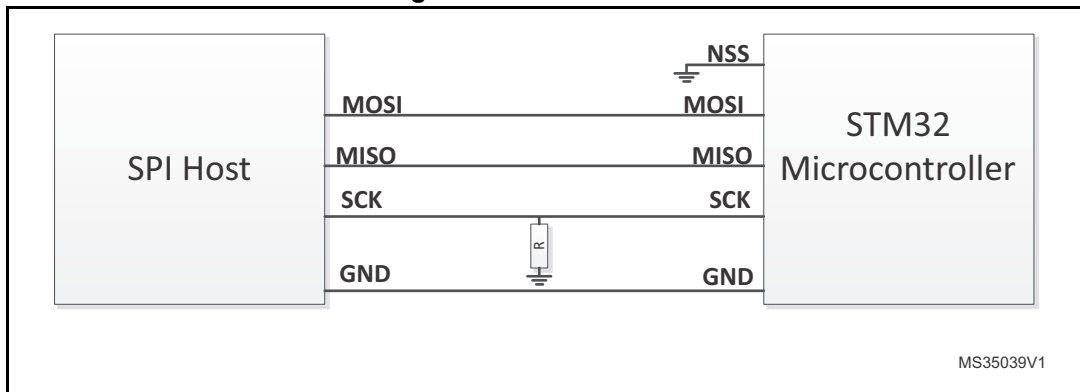

Note: R value typically 10KOhm. These values depend on the application and the used hardware.

To use the CAN interface, the host has to be connected to the (RX) and (TX) pins of the desired CANx interface via CAN transceiver and a serial cable. A 120 ohm resistor should be added as terminating resistor.

Figure 5. CAN Connection

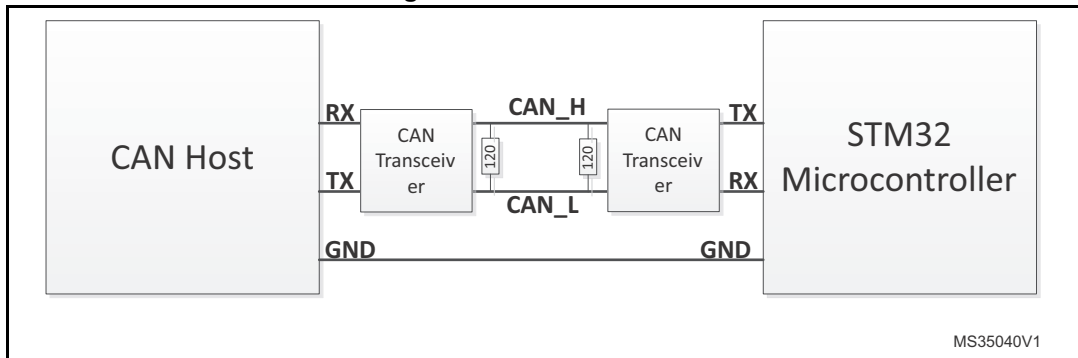

Note: When a bootloader firmware supports DFU, it is mandatory that no USB Host is connected to the USB peripheral during the selection phase of the other interfaces. After selection phase, the user can plug a USB cable without impacting the selected bootloader execution except commands which generate a system reset.

3.4 Bootloader Memory Management

All write operations using bootloader commands must only be Word-aligned (the address should be a multiple of 4). The number of data to be written must also be a multiple of 4 bytes (non-aligned half page write addresses are accepted).

Some Products embeds bootloader that has some specific features:

- Some products don't support Mass erase operation. To perform a mass erase operation using bootloader, two options are available:
 - Erase all sectors one by one using the Erase command
 - Set protection level to Level 1. Then, set it to Level 0 (using the Read protect command and then the Read Unprotect command). This operation results in a mass erase of the internal Flash memory.
- Bootloader firmware of STM32 L1 and L0 series supports Data Memory in addition to standard memories (internal Flash, internal SRAM, option bytes and System memory). The start address of this area is 0x08080000 and the size depend on product, please refer to product reference manual for more information. Data memory can be read and written but cannot be erased using the Erase Command. When writing in a Data memory location, the bootloader firmware manages the erase operation of this location before any write. A write to Data memory must be Word-aligned (address to be written should be a multiple of 4) and the number of data must also be a multiple of 4. To erase a Data memory location, you can write zeros at this location.
- Bootloader firmware of STM32 F2 and F4 series supports OTP memory in addition to standard memories (internal Flash, internal SRAM, option bytes and System memory). The start address of this area is 0x1FFF7800 and the size depend on product, please refer to product reference manual for more information. OTP memory can be read and written but cannot be erased using Erase command. When writing in an OTP memory location, make sure that the relative protection bit (in the last 16 bytes of the OTP memory) is not reset.
- For STM32 F2 and F4 series the internal flash write operation format depends on the voltage range. By default write operation are allowed by one byte format (Half-Word, Word and Double-Word operations are not allowed). To increase the speed of write operation, the user should apply the adequate voltage range that allows write operation

by Half-Word, Word or Double-Word and update this configuration on the fly by the bootloader software through a virtual memory location. This memory location is not physical but can be read and written using usual bootloader read/write operations according to the protocol in use. This memory location contains 4 bytes which are described in table below. It can be accessed by 1, 2, 3 or 4 bytes. However, reserved bytes should remain at their default values (0xFF), otherwise the request will be NACKed.

Table 4. STM32 F2 and F4 Voltage Range configuration using bootloader

Address	Size	Description
0xFFFF0000	1 byte	This byte controls the current value of the voltage range. 0x00: voltage range [1.8 V, 2.1 V] 0x01: voltage range [2.1 V, 2.4 V] 0x02: voltage range [2.4 V, 2.7 V] 0x03: voltage range [2.7 V, 3.6 V] 0x04: voltage range [2.7 V, 3.6 V] and double word write/erase operation is used. In this case it is mandatory to supply 9 V through the VPP pin (refer to the product reference manual for more details about the double-word write procedure). Other: all other values are not supported and will be NACKed.
0xFFFF0001	1 byte	Reserved. 0xFF: default value. Other: all other values are not supported and will be NACKed.
0xFFFF0002	1 byte	Reserved. 0xFF: default value. Other: all other values are not supported and will be NACKed.
0xFFFF0003	1 byte	Reserved. 0xFF: default value. Other: all other values are not supported and will be NACKed.

The table below lists the valid memory area depending on the Bootloader commands.

Table 5. Supported memory area by Write, Read, Erase and Go Commands

Memory Area	Write command	Read command	Erase command	Go command
Flash	Supported	Supported	Supported	Supported
RAM	Supported	Supported	Not Supported	Supported
System Memory	Not Supported	Supported	Not Supported	Not Supported
Data Memory	Supported	Supported	Not Supported	Not Supported
OTP Memory	Supported	Supported	Not Supported	Not Supported

4 STM32F10xxx devices bootloader

4.1 Bootloader configuration

The STM32F10xxx bootloader is activated by applying pattern1 (described in [Table 2: Bootloader activation patterns](#)). The following table shows the hardware resources used by this bootloader.

Table 6. STM32F10xxx configuration in System memory boot mode

Bootloader	Feature/Peripheral	State	Comment
USART1 bootloader	Clock source	HSI enabled	The system clock is equal to 24 MHz using the PLL.
	RAM	-	512 bytes starting from address 0x20000000 are used by the bootloader firmware.
	System memory	-	2 Kbytes starting from address 0x1FFF0000 contain the bootloader firmware.
	IWDG	-	The independent watchdog (IWDG) prescaler is configured to its maximum value and is periodically refreshed to prevent watchdog reset (in case the hardware IWDG option was previously enabled by the user).
	USART1	Enabled	Once initialized, the USART1 configuration is: 8 bits, even parity and 1 Stop bit.
	USART1_RX pin	Input	PA10 pin: USART1 receives.
	USART1_TX pin	Output push-pull	PA9 pin: USART1 transmits.
	SysTick timer	Enabled	Used to automatically detect the serial baud rate from the host.

The system clock is derived from the embedded internal high-speed RC, no external quartz is required for the bootloader execution.

4.2 Bootloader selection

The figure below shows the bootloader detection mechanism.

Figure 6. Bootloader for STM32F10xxx with USART1

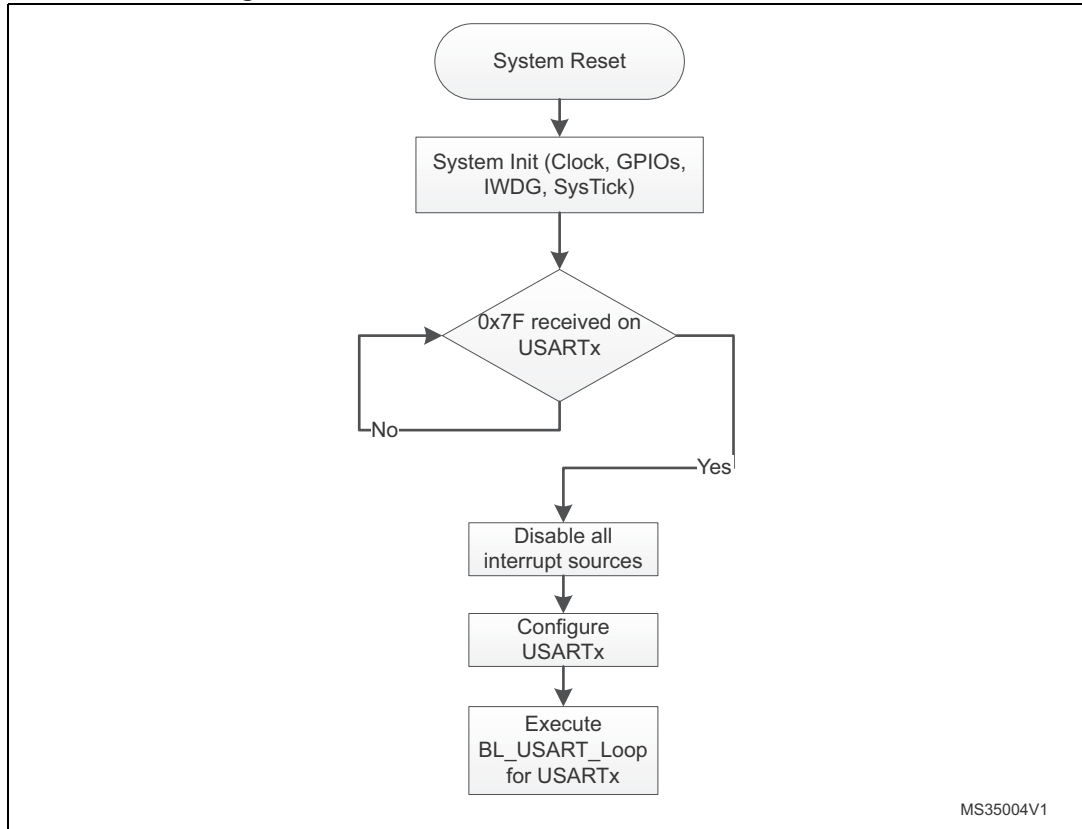

4.3 Bootloader version

The following table lists the STM32F10xxx devices bootloader versions:

Table 7. STM32F10xxx bootloader versions

Bootloader version number	Description
V2.0	Initial bootloader version.
V2.1	<ul style="list-style-type: none"> – Updated Go Command to initialize the main stack pointer – Updated Go command to return NACK when jump address is in the Option byte area or System memory area – Updated Get ID command to return the device ID on two bytes – Update the bootloader version to V2.1
V2.2	<ul style="list-style-type: none"> – Updated Read Memory, Write Memory and Go commands to deny access with a NACK response to the first 0x200 bytes of RAM memory used by the bootloader – Updated Readout Unprotect command to initialize the whole RAM content to 0x0 before ROP disable operation

5 STM32F105xx/107xx devices bootloader

5.1 Bootloader configuration

The STM32F105xx/107xx bootloader is activated by applying pattern1 (described in [Table 2: Bootloader activation patterns](#)). The following table shows the hardware resources used by this bootloader.

Table 8. STM32F105xx/107xx configuration in System memory boot mode

Bootloader	Feature/Peripheral	State	Comment
Common to all bootloaders	RCC	HSI enabled	The system clock frequency is 24 MHz using the PLL. This is used only for USART1 and USART2 bootloaders and during CAN2, USB detection for CAN and DFU bootloaders (Once CAN or DFU bootloader is selected, the clock source will be derived from external crystal).
		HSE enabled	The external clock is mandatory only for DFU and CAN bootloaders and it must provide one of the following frequencies: 8 MHz, 14.7456 MHz or 25 MHz. For CAN bootloader, the PLL is used only to generate 48 MHz when 14.7456 MHz is used as HSE. For DFU bootloader, the PLL is used to generate a 48 MHz system clock from all supported external clock frequencies.
		-	The clock security system (CSS) interrupt is enabled for the CAN and DFU bootloaders. Any failure (or removal) of the external clock will generate system reset.
	IWDG	-	The independent watchdog (IWDG) prescaler is configured to its maximum value and is periodically refreshed to prevent watchdog reset (in case the hardware IWDG option was previously enabled by the user).
	System memory	-	18 Kbytes starting from address 0x1FFF B000 contain the bootloader firmware.
	RAM	-	4 Kbytes starting from address 0x20000000 are used by the bootloader firmware.
USART1 bootloader	USART1	Enabled	Once initialized, the USART1 configuration is: 8 bits, even parity and 1 Stop bit.
	USART1_RX pin	Input	PA10 pin: USART1 receives.
	USART1_TX pin	Output push-pull	PA9 pin: USART1 transmits.
USART1 and USART2 bootloaders	SysTick timer	Enabled	Used to automatically detect the serial baud rate from the host for USARTx bootloader.

Table 8. STM32F105xx/107xx configuration in System memory boot mode (continued)

Bootloader	Feature/Peripheral	State	Comment
USART2 bootloader	USART2	Enabled	Once initialized, the USART2 configuration is: 8 bits, even parity and 1 Stop bit. The USART2 uses its remapped pins.
	USART2_RX pin	Input	PD6 pin: USART2 receive (remapped pin)
	USART2_TX pin	Output push-pull	PD5 pin: USART2 transmit (remapped pin)
CAN2 bootloader	CAN2	Enabled	Once initialized, the CAN2 configuration is: Baudrate 125 kbps, 11-bit identifier. Note: CAN1 is clocked during the CAN bootloader execution because in STM32F105xx and STM32F107xx devices, CAN1 manages the communication between CAN2 and SRAM.
	CAN2_RX pin	Input	PB5 pin: CAN2 receives (remapped pin).
	CAN2_TX pin	Output push-pull	PB6 pin: CAN2 transmits (remapped pin).
DFU bootloader	USB OTG FS	Enabled	USB OTG FS configured in Forced Device mode
	OTG_FS_VBUS pin	Input or alternate function, automatically controlled by the USB OTG FS controller	PA9: Power supply voltage line
	OTG_FS_DM pin		PA11: USB Send-Receive data line
	OTG_FS_DP pin		PA12: USB Send-Receive data line
Interrupts	Enabled	USB_OTG_FS interrupt vector is enabled and used for USB DFU communication.	

The system clock is derived from the embedded internal high-speed RC for USARTx bootloader. This internal clock is used also for DFU and CAN bootloaders but only for the selection phase. An external clock (8 MHz, 14.7456 MHz or 25 MHz.) is required for DFU and CAN bootloader execution after the selection phase.

5.2 Bootloader selection

The figure below shows the bootloader detection mechanism.

Figure 7. Bootloader selection for STM32F105xx/107xx devices

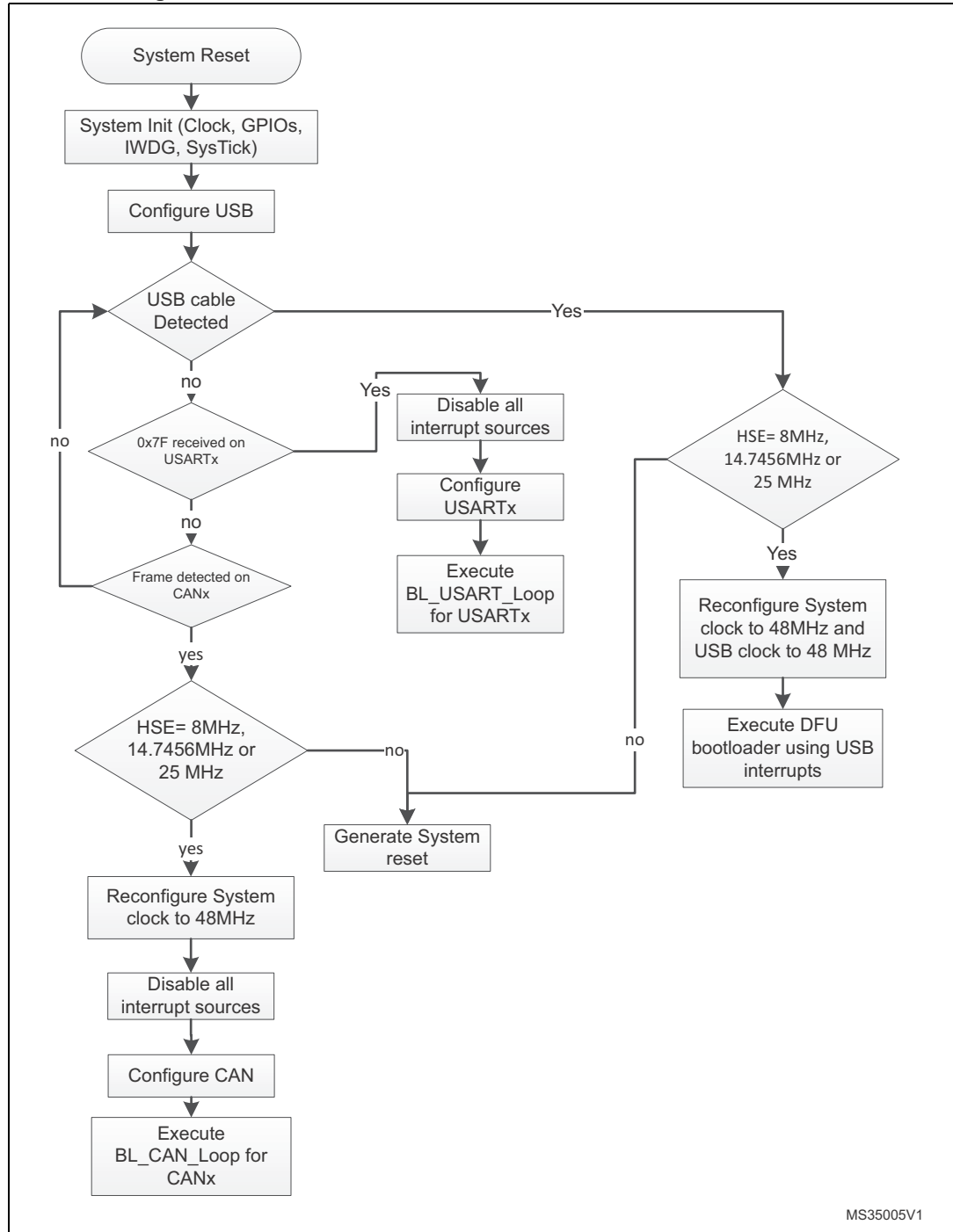

MS35005V1

5.3 Bootloader version

The following table lists the STM32F105xx/107xx devices bootloader versions:

Table 9. STM32F105xx/107xx bootloader versions

Bootloader version number	Description
V1.0	Initial bootloader version.
V2.0	<ul style="list-style-type: none"> – Bootloader detection mechanism updated to fix the issue when GPIOs of unused peripherals in this bootloader are connected to low level or left floating during the detection phase. For more details please refer to Section 5.3.2. – Vector table set to 0x1FFF B000 instead of 0x0000 0000 – Go command updated (for all bootloaders): USART1, USART2, CAN2, GPIOA, GPIOB, GPIOD and SysTick peripheral registers are set to their default reset values – DFU bootloader: USB pending interrupt cleared before executing the Leave DFU command – DFU subprotocol version changed from V1.0 to V1.2 – Bootloader version updated to V2.0
V2.1	<ul style="list-style-type: none"> – Fixed PA9 excessive consumption described in Section 5.3.4. – Get-Version command (defined in AN3155) corrected. It returns 0x22 instead of 0x20 in bootloader V2.0. Refer to Section 5.3.3 for more details. – Bootloader version updated to V2.1
V2.2	<ul style="list-style-type: none"> – Fixed DFU option bytes descriptor (set to 'e' instead of 'g' because it is read/write and not erasable). – Fixed DFU polling timings for Flash Read/Write/Erase operations. – Robustness enhancements for DFU bootloader interface. – Updated bootloader version to V2.2.

5.3.1 How to identify STM32F105xx/107xx bootloader versions

Bootloader V1.0 is implemented on devices which date code is below 937 (refer to STM32F105xx and STM32F107xx datasheet for where to find the date code on the device marking). Bootloader V2.0 and V2.1 are implemented on devices with a date code higher or equal to 937.

There are two ways to distinguish between bootloader versions:

- When using the USART bootloader, the Get-Version command defined in AN2606 and AN3155 has been corrected in V2.1 version. It returns 0x22 instead of 0x20 as in bootloader V2.0.

- The values of the vector table at the beginning of the bootloader code are different. The user software (or via JTAG/SWD) reads 0x1FFFE945 at address 0x1FFFB004 for bootloader V2.0 0x1FFFE9A1 for bootloader V2.1, and 0x1FFFE9C1 for bootloader V2.2.
- The DFU version is the following:
 - V2.1 in bootloader V2.1
 - V2.2 in bootloader V2.2.It can be read through the `bcdDevice` field of the DFU Device Descriptor.

5.3.2 Bootloader unavailability on STM32F105xx/STM32F107xx devices with a date code below 937

Description

The bootloader cannot be used if the USART1_RX (PA10), USART2_RX (PD6, remapped), CAN2_Rx (PB5, remapped), OTG_FS_DM (PA11), and/or OTG_FS_DP (PA12) pin(s) are held low or left floating during the bootloader activation phase.

The bootloader cannot be connected through CAN2 (remapped), DFU (OTG FS in Device mode), USART1 or USART2 (remapped).

On 64-pin packages, the USART2_RX signal remapped PD6 pin is not available and it is internally grounded. In this case, the bootloader cannot be used at all.

Workaround

- For 64-pin packages
None. The bootloader cannot be used.
- For 100-pin packages
Depending on the used peripheral, the pins for the unused peripherals have to be kept at a high level during the bootloader activation phase as described below:
 - If USART1 is used to connect to the bootloader, PD6 and PB5 have to be kept at a high level.
 - If USART2 is used to connect to the bootloader, PA10, PB5, PA11 and PA12 have to be kept at a high level.
 - If CAN2 is used to connect to the bootloader, PA10, PD6, PA11 and PA12 have to be kept at a high level.
 - If DFU is used to connect to the bootloader, PA10, PB5 and PD6 have to be kept at a high level.

Note: This limitation applies only to STM32F105xx and STM32F107xx devices with a date code below 937. STM32F105xx and STM32F107xx devices with a date code higher or equal to 937 are not impacted. See STM32F105xx and STM32F107xx datasheet for where to find the date code on the device marking.

5.3.3 USART bootloader Get-Version command returns 0x20 instead of 0x22

Description

In USART mode, the Get-Version command (defined in AN3155) returns 0x20 instead of 0x22.

This limitation is present on bootloader versions V1.0 and V2.0, while it is fixed in bootloader version 2.1.

Workaround

None.

5.3.4 PA9 excessive power consumption when USB cable is plugged in bootloader V2.0

Description

When connecting an USB cable after booting from System-Memory mode, PA9 pin (connected to $V_{BUS}=5\text{ V}$) is also shared with USART TX pin which is configured as alternate push-pull and forced to 0 since the USART peripheral is not yet clocked. As a consequence, a current higher than 25 mA is drained by PA9 I/O and may affect the I/O pad reliability.

This limitation is fixed in bootloader version 2.1 by configuring PA9 as alternate function push-pull when a correct 0x7F is received on RX pin and the USART is clocked. Otherwise, PA9 is configured as alternate input floating.

Workaround

None.

6 STM32F10xxx XL-density devices bootloader

6.1 Bootloader configuration

The STM32F10xxx XL-density is activated by applying pattern3 (described in [Table 2: Bootloader activation patterns](#)). The following table shows the hardware resources used by this bootloader:

Table 10. STM32F10xxx XL-density configuration in System memory boot mode

Bootloader	Feature/peripheral	State	Comment
Common to all bootloaders	Clock source	HSI enabled	The system clock is equal to 24 MHz using the PLL.
	RAM	-	2 Kbytes starting from address 0x2000 0000 are used by the bootloader firmware.
	System memory	-	6 Kbytes starting from address 0x1FFF E000 contain the bootloader firmware.
	IWDG	-	The independent watchdog (IWDG) prescaler is configured to its maximum value and is periodically refreshed to prevent watchdog reset (in case the hardware IWDG option was previously enabled by the user).
USART1 bootloader	USART1	Enabled	Once initialized, the USART1 configuration is: 8 bits, even parity and 1 Stop bit.
	USART1_RX pin	Input	PA10 pin: USART1 receives.
	USART1_TX pin	Output push-pull	PA9 pin: USART1 transmits.
USART2 bootloader	USART2	Enabled	Once initialized, the USART2 configuration is: 8 bits, even parity and 1 Stop bit.
	USART2_RX pin	Input	PD6 pin: USART2 receives (remapped pins).
	USART2_TX pin	Output push-pull	PD5 pin: USART2 transmits (remapped pins).
USART1 and USART2 bootloaders	SysTick timer	Enabled	Used to automatically detect the serial baud rate from the host.

The system clock is derived from the embedded internal high-speed RC, no external quartz is required for the bootloader execution.

6.2 Bootloader selection

The figure below shows the bootloader detection mechanism.

Figure 8. Bootloader selection for STM32F10xxx XL-density devices

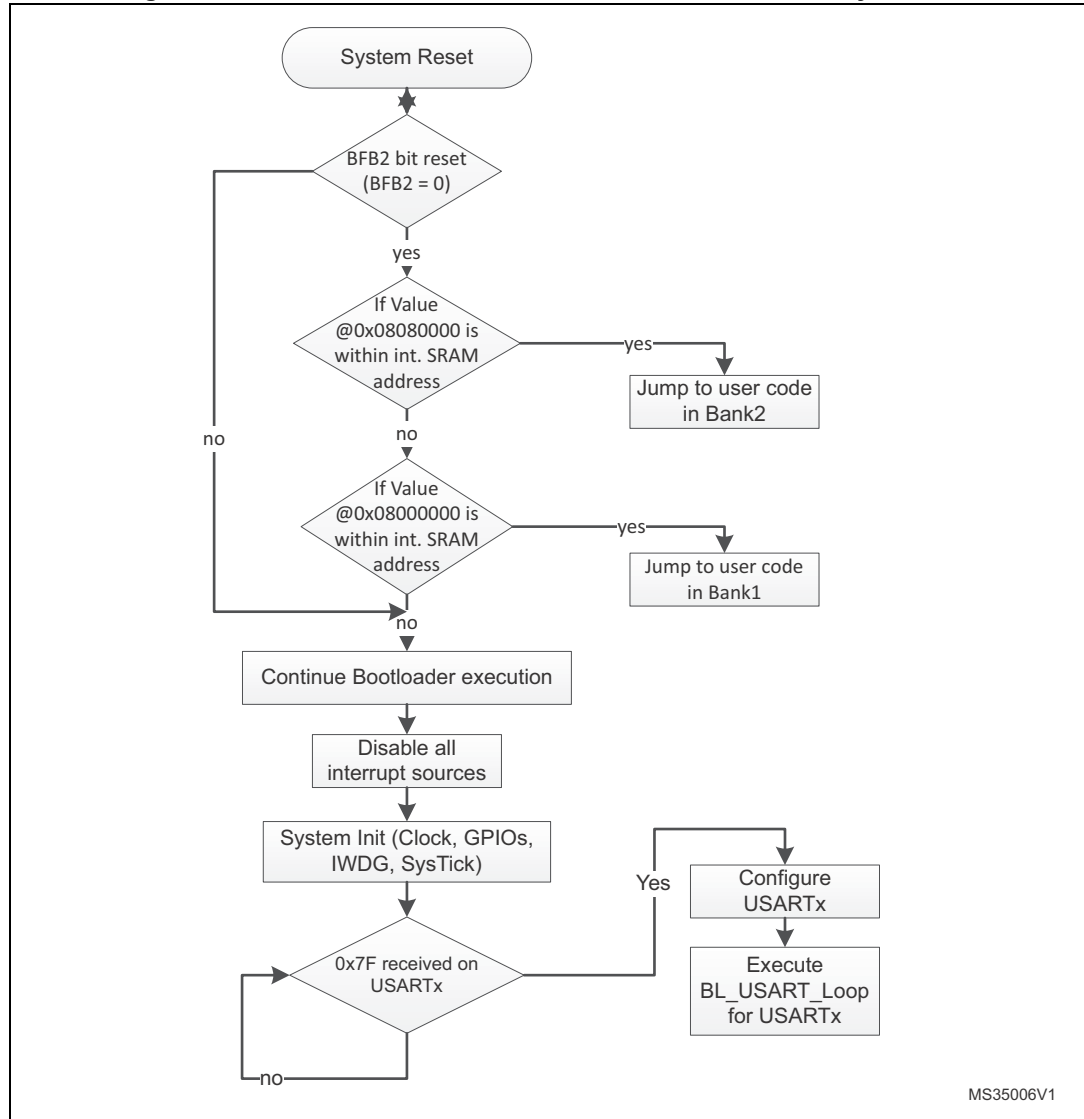

6.3 Bootloader version

The following table lists the STM32F10xxx XL-density devices bootloader versions:

Table 11. XL-density bootloader versions

Bootloader version number	Description
V2.1	Initial bootloader version

7 STM32L1xxx6(8/B) devices bootloader

7.1 Bootloader configuration

The STM32L1xxx6(8/B) bootloader is activated by applying pattern1 (described in [Table 2: Bootloader activation patterns](#)). The following table shows the hardware resources used by this bootloader.

Table 12. STM32L1xxx6(8/B) configuration in System memory boot mode

Bootloader	Feature/peripheral	State	Comment
Common to all bootloaders	Clock source	HSI enabled	The system clock is equal to 16 MHz.
	RAM	-	2 Kbytes starting from address 0x20000000 are used by the bootloader firmware.
	System memory	-	4 Kbytes starting from address 0x1FF00000 contain the bootloader firmware.
	IWDG	-	The independent watchdog (IWDG) prescaler is configured to its maximum value and is periodically refreshed to prevent watchdog reset (in case the hardware IWDG option was previously enabled by the user).
	Power	-	Voltage range is set to Voltage Range 1.
USART1 bootloader	USART1	Enabled	Once initialized, the USART1 configuration is: 8 bits, even parity and 1 Stop bit.
	USART1_RX pin	Input	PA10 pin: USART1 receives.
	USART1_TX pin	Output	PA9 pin: USART1 transmits.
USART2 bootloader	USART2	Enabled	Once initialized, the USART2 configuration is: 8 bits, even parity and 1 Stop bit.
	USART2_RX pin	Input	PD06 pin: USART2 receives.
	USART2_TX pin	Output	PD05 pin: USART2 transmits.
USART1 and USART2 bootloaders	SysTick timer	Enabled	Used to automatically detect the serial baud rate from the host.

The system clock is derived from the embedded internal high-speed RC, no external quartz is required for the bootloader execution.

7.2 Bootloader selection

The figure below shows the bootloader detection mechanism.

Figure 9. Bootloader selection for STM32L1xxx6(8/B) devices

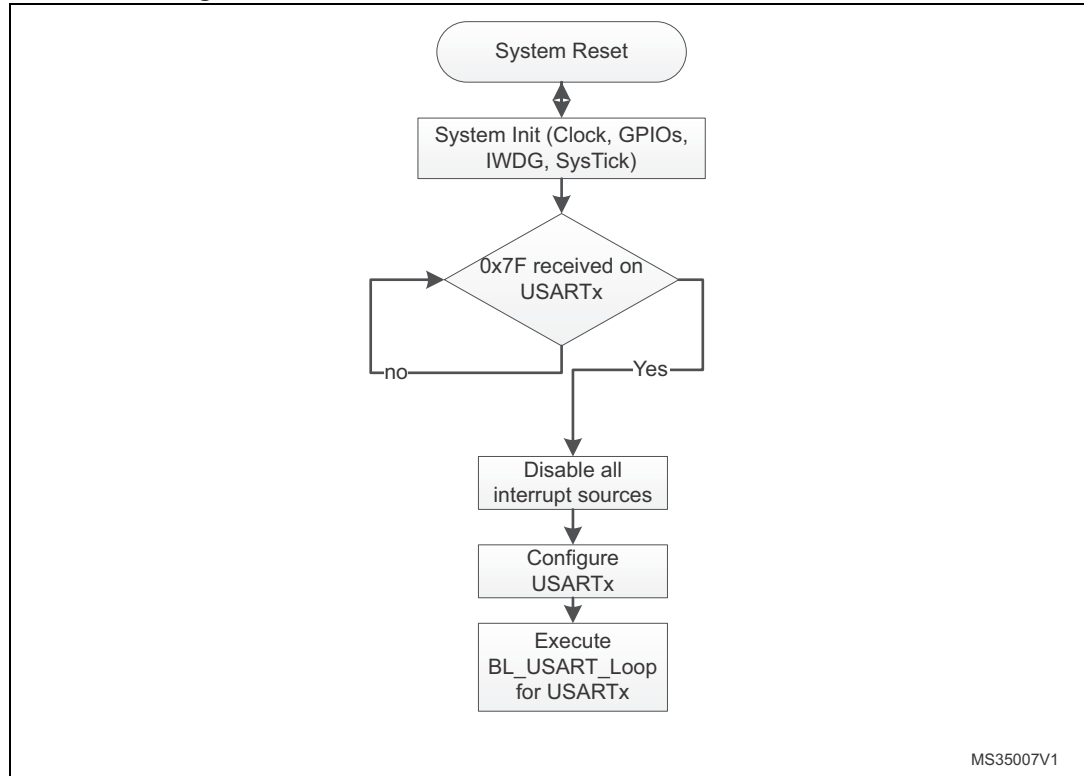

7.3 Bootloader version

The following table lists the STM32L1xxx6(8/B) bootloader versions:

Table 13. STM32L1xxx6(8/B) bootloader versions

Bootloader version number	Description	Known limitations
V2.0	Initial bootloader version.	When a Read Memory command or Write Memory command is issued with an unsupported memory address and a correct address checksum (ie. address 0x6000 0000), the command is aborted by the bootloader device, but the NACK (0x1F) is not sent to the host. As a result, the next 2 bytes (which are the number of bytes to be read/written and its checksum) are considered as a new command and its checksum. ⁽¹⁾

1. If the “number of data - 1” (N-1) to be read/written is not equal to a valid command code, then the limitation is not perceived from the host since the command is NACKed anyway (as an unsupported new command).

8 STM32L1xxxC devices bootloader

8.1 Bootloader configuration

The STM32L1xxxC bootloader is activated by applying pattern1 (described in [Table 2: Bootloader activation patterns](#)). The following table shows the hardware resources used by this bootloader.

Table 14. STM32L1xxxC configuration in System memory boot mode

Bootloader	Feature/Peripheral	State	Comment
Common to all bootloaders	RCC	HSI enabled	The system clock frequency is 16 MHz using the HSI. This is used only for USART1 and USART2 bootloaders and during USB detection for DFU bootloader (once the DFU bootloader is selected, the clock source is derived from the external crystal).
		HSE enabled	The external clock is mandatory only for the DFU bootloader and must be in the following range: [24, 16, 12, 8, 6, 4, 3, 2] MHz. The PLL is used to generate the USB 48 MHz clock and the 32 MHz clock for the system clock.
		-	The clock security system (CSS) interrupt is enabled for the DFU bootloader. Any failure (or removal) of the external clock generates a system reset.
	IWDG	-	The independent watchdog (IWDG) prescaler is configured to its maximum value and is periodically refreshed to prevent watchdog resets (in case the hardware IWDG option was previously enabled by the user).
	Power		Voltage range is set to Voltage Range 1.
	System memory	-	8 Kbytes starting from address 0x1FF0 0000. This area contains the bootloader firmware.
	RAM	-	4 Kbytes starting from address 0x20000000 are used by the bootloader firmware.
USART1 bootloader	USART1	Enabled	Once initialized, the USART1 configuration is 8 bits, even parity and 1 stop bit.
	USART1_RX pin	Input	PA10 pin: USART1 in reception mode
	USART1_TX pin	Output	PA9 pin: USART1 in transmission mode
USART1 and USART2 bootloaders	SysTick timer	Enabled	Used to automatically detect the serial baud rate from the host for the USARTx bootloader.

Table 14. STM32L1xxxC configuration in System memory boot mode (continued)

Bootloader	Feature/Peripheral	State	Comment
USART2 bootloader	USART2	Enabled	Once initialized, the USART2 configuration is 8 bits, even parity and 1 stop bit. The USART2 uses its remapped pins.
	USART2_RX pin	Input	PD6 pin: USART2 in reception mode
	USART2_TX pin	Output	PD5 pin: USART2 in transmission mode
DFU bootloader	USB_DM pin	Input or alternate function, automatically controlled by the USB	PA11: USB send-receive data line.
	USB_DP pin		PA12: USB send-receive data line An external pull-up resistor 1.5 Kohm must be connected to USB_DP pin.
	Interrupts	Enabled	USB low priority interrupt vector is enabled and used for USB DFU communication.

The system clock is derived from the embedded internal high-speed RC for the USARTx bootloader. This internal clock is also used the for DFU bootloader but only for the selection phase. An external clock in the range of [24, 16, 12, 8, 6, 4, 3, 2] MHz is required for the execution of the DFU bootloader after the selection phase.

8.2 Bootloader selection

The figure below shows the bootloader detection mechanism.

Figure 10. Bootloader selection for STM32L1xxxC devices

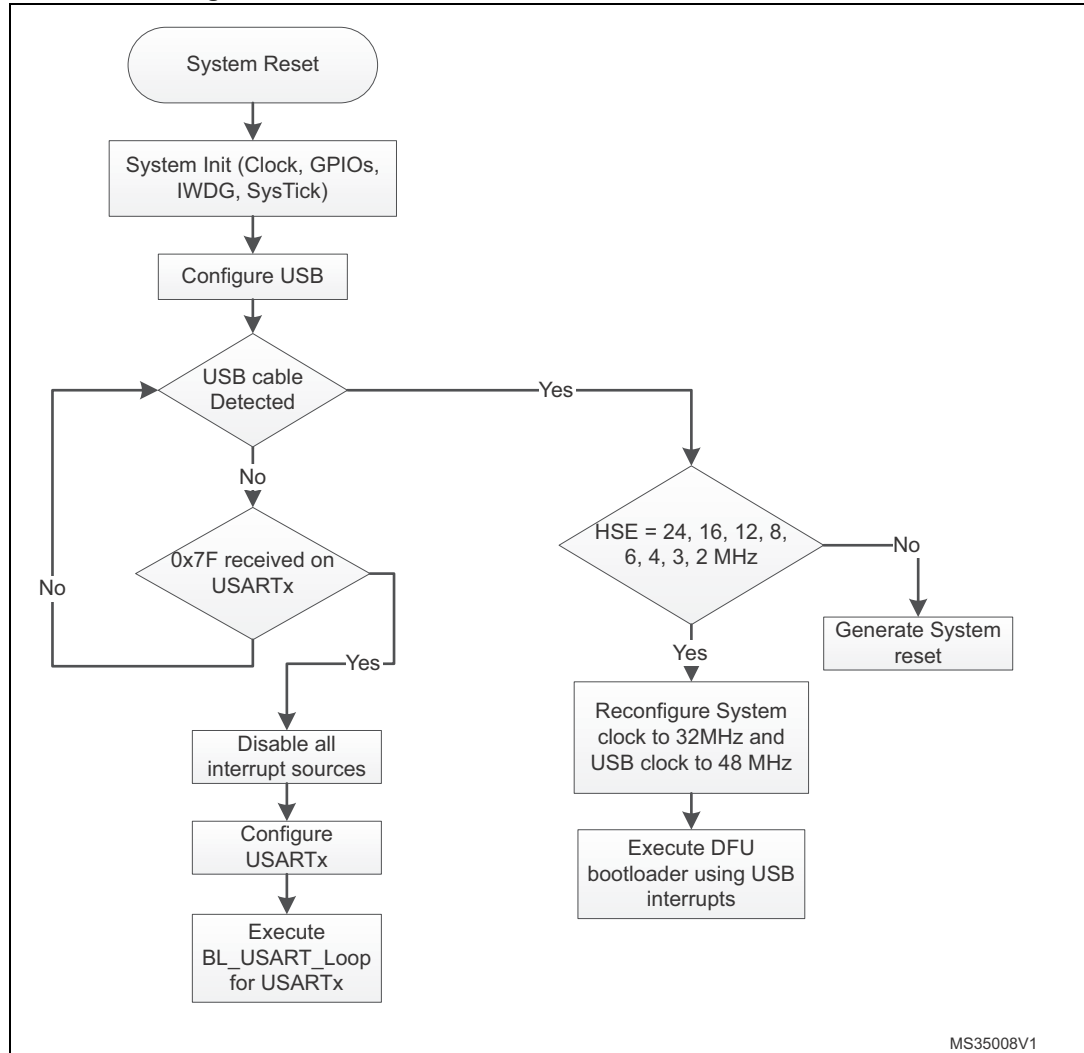

MS35008V1

8.3 Bootloader version

The following table lists the STM32L1xxxC devices bootloader versions:

Table 15. STM32L1xxxC bootloader versions

Bootloader version number	Description	Known limitations
V4.0	Initial bootloader version	For the USART interface, two consecutive NACKs instead of 1 NACK are sent when a Read Memory or Write Memory command is sent and the RDP level is active.

9 STM32L1xxxD devices bootloader

9.1 Bootloader configuration

The STM32L1xxxD bootloader is activated by applying pattern4 (described in [Table 2: Bootloader activation patterns](#)). The following table shows the hardware resources used by this bootloader.

Table 16. STM32L1xxxD configuration in System memory boot mode

Bootloader	Feature/Peripheral	State	Comment
Common to all bootloaders	RCC	HSI enabled	The system clock frequency is 16 MHz using the HSI. This is used only for USART1 and USART2 bootloaders and during USB detection for DFU bootloader (once the DFU bootloader is selected, the clock source will be derived from the external crystal).
		HSE enabled	The external clock is mandatory only for DFU bootloader and it must be in the following range: [24, 16, 12, 8, 6, 4, 3, 2] MHz. The PLL is used to generate the USB 48 MHz clock and the 32 MHz clock for the system clock.
		-	The clock security system (CSS) interrupt is enabled for the DFU bootloader. Any failure (or removal) of the external clock generates system reset.
	IWDG	-	The independent watchdog (IWDG) prescaler is configured to its maximum value and is periodically refreshed to prevent watchdog reset (in case the hardware IWDG option was previously enabled by the user).
	Power		Voltage range is set to Voltage Range 1.
	System memory	-	8 Kbytes starting from address 0x1FF0 0000. This area contains the bootloader firmware.
	RAM	-	4 Kbytes starting from address 0x20000000 are used by the bootloader firmware.
USART1 bootloader	USART1	Enabled	Once initialized, the USART1 configuration is: 8 bits, even parity and 1 Stop bit.
	USART1_RX pin	Input	PA10 pin: USART1 in reception mode
	USART1_TX pin	Output	PA9 pin: USART1 in transmission mode
USART1 and USART2 bootloaders	SysTick timer	Enabled	Used to automatically detect the serial baud rate from the host for USARTx bootloader.

Table 16. STM32L1xxxD configuration in System memory boot mode (continued)

Bootloader	Feature/Peripheral	State	Comment
USART2 bootloader	USART2	Enabled	Once initialized, the USART2 configuration is: 8 bits, even parity and 1 Stop bit. The USART2 uses its remapped pins.
	USART2_RX pin	Input	PD6 pin: USART2 in reception mode
	USART2_TX pin	Output	PD5 pin: USART2 in transmission mode
DFU bootloader	USB_DM pin	Input or alternate function, automatically controlled by the USB	PA11: USB Send-Receive data line
	USB_DP pin		PA12: USB Send-Receive data line An external pull-up resistor 1.5 Kohm must be connected to USB_DP pin.
	Interrupts	Enabled	USB Low Priority interrupt vector is enabled and used for USB DFU communication.

The system clock is derived from the embedded internal high-speed RC for USARTx bootloader. This internal clock is used also for DFU bootloader but only for the selection phase. An external clock in the range of [24, 16, 12, 8, 6, 4, 3, 2] MHz is required for DFU bootloader execution after the selection phase.

9.2 Bootloader selection

The figure below shows the bootloader detection mechanism.

Figure 11. Bootloader selection for STM32L1xxxD devices

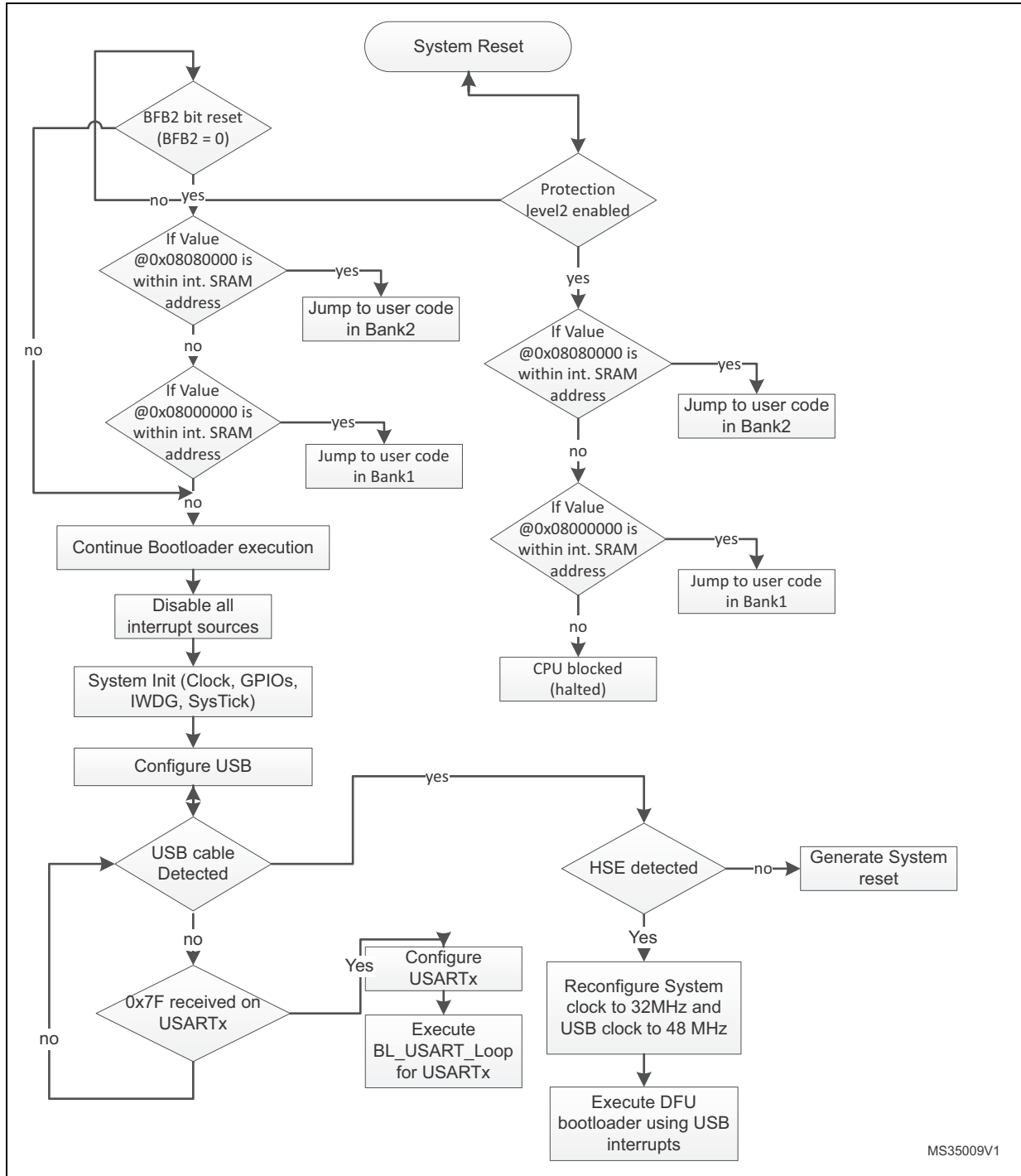

MS35009V1

9.3 Bootloader version

The following table lists the STM32L1xxxD devices bootloader versions:

Table 17. STM32L1xxxD bootloader versions

Bootloader version number	Description	Known limitations
V4.1	Initial bootloader version	<ul style="list-style-type: none"> – In the bootloader code the PA13 (JTMS/SWDIO) I/O output speed is configured to 400 KHz, as consequence some debugger can not connect to the device in Serial Wire mode when the bootloader is running. – When the DFU bootloader is selected, the RTC is reset and thus all RTC information (calendar, alarm, ...) will be lost including backup registers. Note: When the USART bootloader is selected there is no change on the RTC configuration (including backup registers).
V4.2	Fix V4.1 limitations (available on Rev.Z devices only.)	<ul style="list-style-type: none"> – Stack overflow by 8 bytes when jumping to Bank1/Bank2 if BFB2=0 or when Read Protection level is set to 2. Workaround: the user code should force in the startup file the top of stack address before to jump to the main program. This can be done in the "Reset_Handler" routine. – When the Stack of the user code is placed outside the SRAM (ie. @ 0x2000C000) the bootloader cannot jump to that user code which is considered invalid. This might happen when using compilers which place the stack at a non-physical address at the top of the SRAM (ie. @ 0x2000C000). Workaround: place manually the stack at a physical address.
V4.5	Fix V4.2 limitations. DFU interface robustness enhancements (available on Rev.Y devices only).	<ul style="list-style-type: none"> – For the USART interface, two consecutive NACKs (instead of 1 NACK) are sent when a Read Memory or Write Memory command is sent and the RDP level is active.

10 STM32F2xxxx devices bootloader

Two bootloader versions are available on STM32F2xxxx devices:

- V2.0 supporting USART1 and USART3
This version is embedded in STM32F2xxxx devices revision B.
- V3.2 supporting USART1, USART3, CAN2 and DFU (USB FS Device)
This version is embedded in STM32F2xxxx devices revision X and Y.

10.1 Bootloader V2.x

10.1.1 Bootloader configuration

The STM32F2xxxx bootloader is activated by applying pattern1 (described in [Table 2: Bootloader activation patterns](#)). The following table shows the hardware resources used by this bootloader.

Table 18. STM32F2xxxx configuration in System memory boot mode

Bootloader	Feature/Peripheral	State	Comment
Common to all bootloaders	Clock source	HSI enabled	The system clock is equal to 24 MHz.
	RAM	-	8 Kbytes starting from address 0x2000 0000.
	System memory	-	30688 bytes starting from address 0x1FFF 0000 contain the bootloader firmware.
	IWDG	-	The independent watchdog (IWDG) prescaler is configured to its maximum value and is periodically refreshed to prevent watchdog reset (in case the hardware IWDG option was previously enabled by the user).
	Power	-	Voltage range is set to [1.62 V, 2.1 V]. In this range internal Flash write operations are allowed only in byte format (Half-Word, Word and Double-Word operations are not allowed). The voltage range can be configured in run time using bootloader commands.
USART1 bootloader	USART1	Enabled	Once initialized, the USART1 configuration is: 8 bits, even parity and 1 Stop bit.
	USART1_RX pin	Input	PA10 pin: USART1 receives.
	USART1_TX pin	Output	PA9 pin: USART1 transmits.
USART3 bootloader (on PC10/PC11)	USART3	Enabled	Once initialized, the USART3 configuration is: 8 bits, even parity and 1 Stop bit.
	USART3_RX pin	Input	PC11 pin: USART3 receives.
	USART3_TX pin	Output	PC10pin: USART3 transmits.

Table 18. STM32F2xxxx configuration in System memory boot mode (continued)

Bootloader	Feature/Peripheral	State	Comment
USART3 bootloader (on PB10/PB11)	USART3	Enabled	Once initialized, the USART3 configuration is: 8 bits, even parity and 1 Stop bit
	USART3_RX pin	Input	PB11 pin: USART3 receives.
	USART3_TX pin	Output	PB10 pin: USART3 transmits.
USART1 and USART3 bootloaders	SysTick timer	Enabled	Used to automatically detect the serial baud rate from the host.

The system clock is derived from the embedded internal high-speed RC. No external quartz is required for the bootloader code.

10.1.2 Bootloader selection

The figure below shows the bootloader detection mechanism.

Figure 12. Bootloader V2.x selection for STM32F2xxxx devices

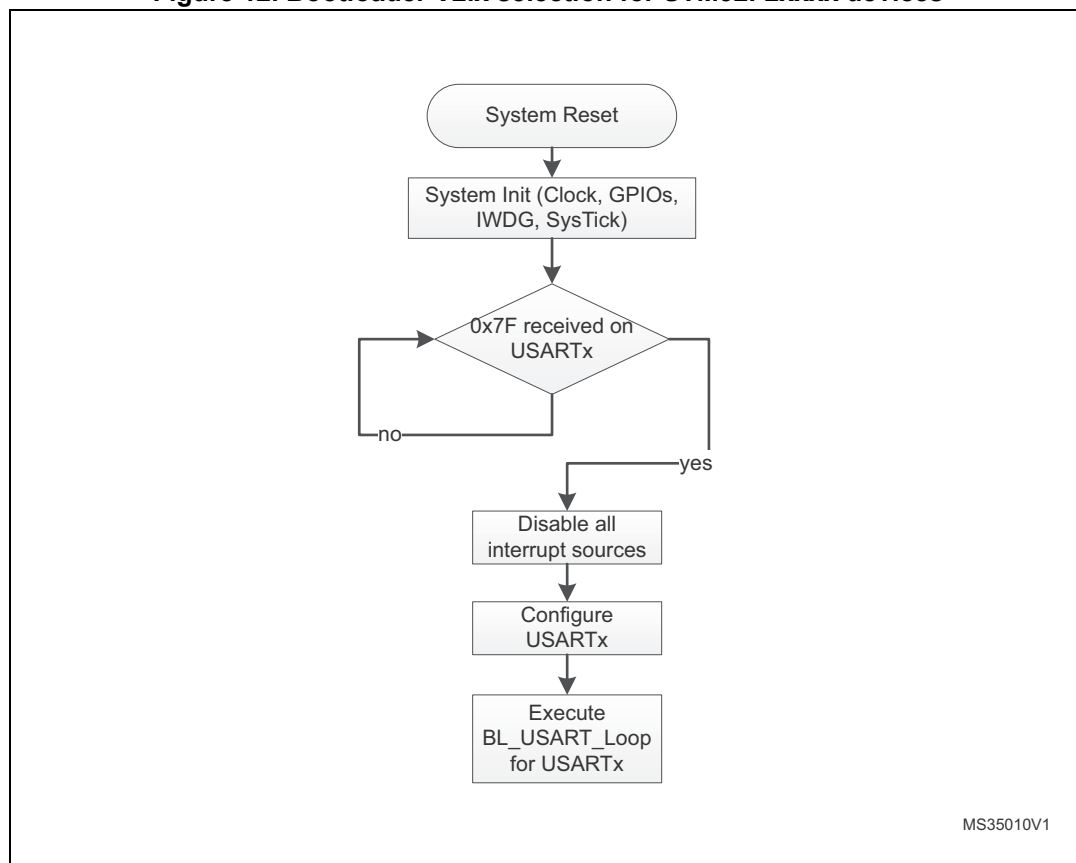

10.1.3 Bootloader version

This following table lists the STM32F2xxxx devices V2.x bootloader versions:

Table 19. STM32F2xxxx bootloader V2.x versions

Bootloader version number	Description	Known limitations
V2.0	Initial V2.x bootloader version	<p>When a Read Memory command or Write Memory command is issued with an unsupported memory address and a correct address checksum (ie. address 0x6000 0000), the command is aborted by the bootloader device, but the NACK (0x1F) is not sent to the host. As a result, the next 2 bytes (which are the number of bytes to be read/written and its checksum) are considered as a new command and its checksum.</p> <p>For the CAN interface, the Write Unprotect command is not functional. Instead you can use Write Memory command and write directly to the option bytes in order to disable the write protection.⁽¹⁾</p>

1. If the “number of data - 1” (N-1) to be read/written is not equal to a valid command code (0x00, 0x01, 0x02, 0x11, 0x21, 0x31, 0x43, 0x44, 0x63, 0x73, 0x82 or 0x92), then the limitation is not perceived from the host since the command is NACKed anyway (as an unsupported new command).

10.2 Bootloader V3.x

10.2.1 Bootloader configuration

The STM32F2xxxx bootloader is activated by applying pattern1 (described in [Table 2: Bootloader activation patterns](#)). The following table shows the hardware resources used by this bootloader.

Table 20. STM32F2xxxx configuration in System memory boot mode

Bootloader	Feature/Peripheral	State	Comment
Common to all bootloaders	RCC	HSI enabled	The system clock is equal to 24 MHz using the PLL. The HSI clock source is used at startup (interface detection phase) and when USARTx interfaces are selected (once CAN or DFU bootloader is selected, the clock source will be derived from external crystal).
		HSE enabled	The system clock is equal to 60 MHz. The HSE clock source is used only when the CAN or the DFU (USB FS Device) interfaces are selected. The external clock must provide a frequency multiple of 1 MHz and ranging from 4 MHz to 26 MHz.
		-	The Clock Security System (CSS) interrupt is enabled for the CAN and DFU bootloaders. Any failure (or removal) of the external clock generates system reset.
	RAM	-	8 Kbytes starting from address 0x20000000 are used by the bootloader firmware.
	System memory	-	30688 bytes starting from address 0x1FF0 0000 contain the bootloader firmware.
	IWDG	-	The independent watchdog (IWDG) prescaler is configured to its maximum value. It is periodically refreshed to prevent watchdog reset (in case the hardware IWDG option was previously enabled by the user).
	Power	-	Voltage range is set to [1.62 V, 2.1 V]. In this range internal Flash write operations are allowed only in byte format (Half-Word, Word and Double-Word operations are not allowed). The voltage range can be configured in run time using bootloader commands.

Table 20. STM32F2xxxx configuration in System memory boot mode (continued)

Bootloader	Feature/Peripheral	State	Comment
USART1 bootloader	USART1	Enabled	Once initialized, the USART1 configuration is: 8 bits, even parity and 1 Stop bit.
	USART1_RX pin	Input	PA10 pin: USART1 in reception mode
	USART1_TX pin	Output	PA9 pin: USART1 in transmission mode
USART3 bootloader (on PB10/PB11)	USART3	Enabled	Once initialized, the USART3 configuration is: 8 bits, even parity and 1 Stop bit.
	USART3_RX pin	Input	PB11 pin: USART3 in reception mode
	USART3_TX pin	Output	PB10pin: USART3 in transmission mode
USART3 bootloader (on PC10/PC11)	USART3	Enabled	Once initialized, the USART3 configuration is: 8 bits, even parity and 1 Stop bit.
	USART3_RX pin	Input	PC11 pin: USART3 in reception mode
	USART3_TX pin	Output	PC10pin: USART3 in transmission mode
USART1 and USART3 bootloaders	SysTick timer	Enabled	Used to automatically detect the serial baud rate from the host for USARTx bootloaders.
CAN2 bootloader	CAN2	Enabled	Once initialized, the CAN2 configuration is: Baudrate 125 kbps, 11-bit identifier. Note: CAN1 is clocked during CAN2 bootloader execution because STM32F2xxxx CAN1 manages the communication between CAN2 and SRAM.
	CAN2_RX pin	Input	PB05 pin: CAN2 in reception mode
	CAN2_TX pin	Output	PB13pin: CAN2 in transmission mode
DFU bootloader	USB_OTG_FS	Enabled	USB OTG FS configured in Forced Device mode. USB_OTG_FS interrupt vector is enabled and used for USB DFU communications.
	USB_OTG_FS_DM pin	Input	PA11 pin: USB OTG FS DM line
	USB_OTG_FS_DP pin	Output	PA12pin: USB OTG FS DP line
CAN2 and DFU bootloaders	TIM11	Enabled	This timer is used to determine the value of the external clock frequency. Once the external clock frequency is determined, the RCC system is configured to operate at 60 MHz system clock (using PLL).

The system clock is derived from the embedded internal high-speed RC for USARTx bootloaders. This internal clock is also used for CAN and DFU (USB FS Device) but only for the selection phase. An external clock multiple of 1 MHz (between 4 and 26 MHz) is required for CAN and DFU bootloader execution after the selection phase.

10.2.2 Bootloader selection

The figure below shows the bootloader detection mechanism.

Figure 13. Bootloader V3.x selection for STM32F2xxxx devices

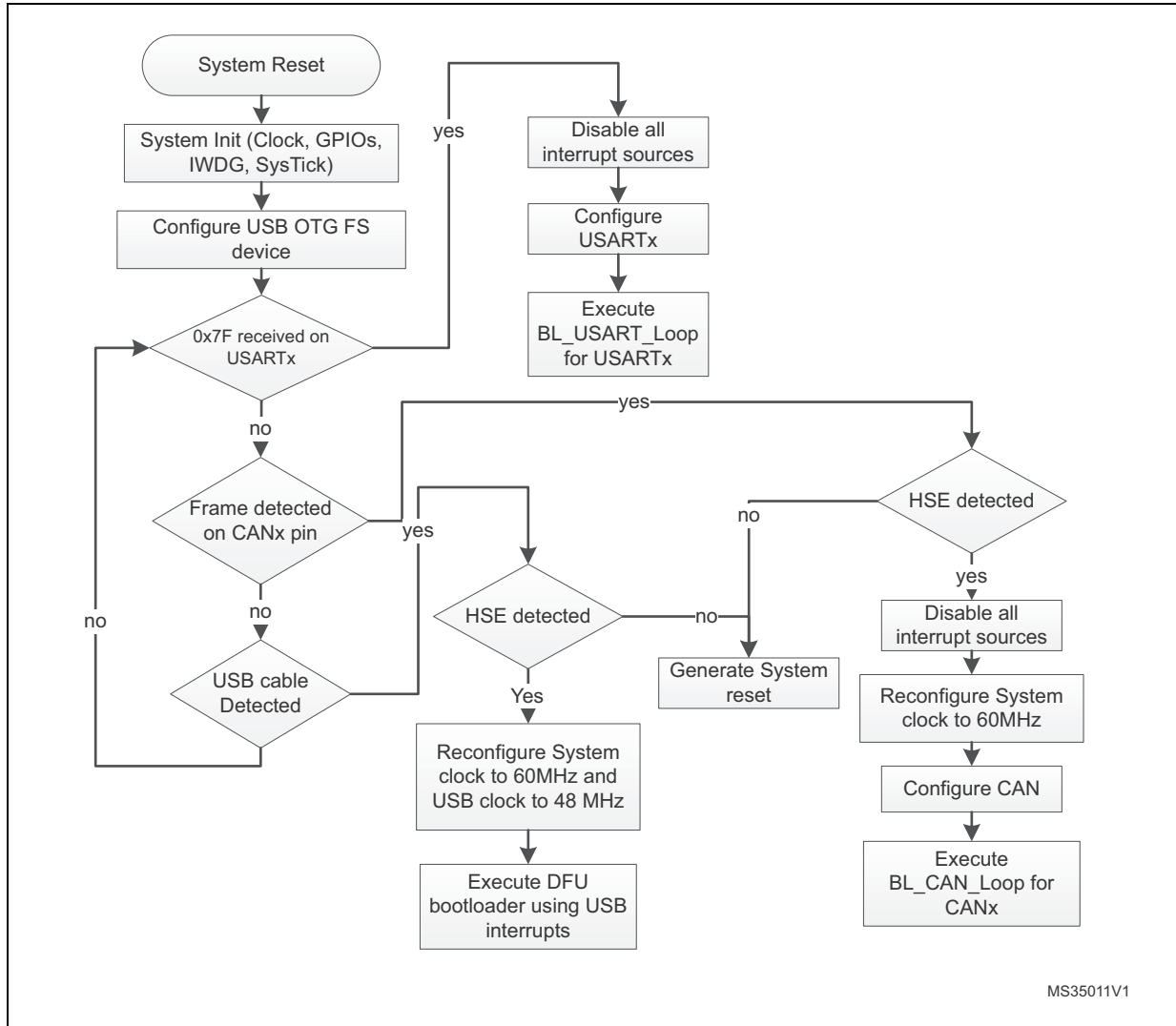

10.2.3 Bootloader version

The following table lists the STM32F2xxxx devices V3.x bootloader versions:

Table 21. STM32F2xxxx bootloader V3.x versions

Bootloader version number	Description	Known limitations
V3.2	Initial V3.x bootloader version.	<ul style="list-style-type: none"> – When a Read Memory command or Write Memory command is issued with an unsupported memory address and a correct address checksum (ie. address 0x6000 0000), the command is aborted by the bootloader device, but the NACK (0x1F) is not sent to the host. As a result, the next 2 bytes (which are the number of bytes to be read/written and its checksum) are considered as a new command and its checksum⁽¹⁾. – Option bytes, OTP and Device Feature descriptors (in DFU interface) are set to “g” instead of “e” (not erasable memory areas).
V3.3	Fix V3.2 limitations. DFU interface robustness enhancement.	<ul style="list-style-type: none"> – For the USART interface, two consecutive NACKs (instead of 1 NACK) are sent when a Read Memory or Write Memory command is sent and the RDP level is active.

1. If the “number of data - 1” (N-1) to be read/written is not equal to a valid command code (0x00, 0x01, 0x02, 0x11, 0x21, 0x31, 0x43, 0x44, 0x63, 0x73, 0x82 or 0x92), then the limitation is not perceived from the host since the command is NACKed anyway (as an unsupported new command).

11 STM32F40xxx/41xxx devices bootloader

11.1 Bootloader V3.x

11.1.1 Bootloader configuration

The STM32F40xxx/41xxx bootloader is activated by applying pattern1 (described in [Table 2: Bootloader activation patterns](#)). The following table shows the hardware resources used by this bootloader.

Table 22. STM32F40xxx/41xxx configuration in System memory boot mode

Bootloader	Feature/Peripheral	State	Comment
Common to all bootloaders	RCC	HSI enabled	The system clock is equal to 24 MHz using the PLL. The HSI clock source is used at startup (interface detection phase) and when USARTx interfaces are selected (once CAN or DFU bootloader is selected, the clock source will be derived from external crystal).
		HSE enabled	The system clock is equal to 60 MHz. The HSE clock source is used only when the CAN or the DFU (USB FS Device) interfaces are selected. The external clock must provide a frequency multiple of 1 MHz and ranging from 4 MHz to 26 MHz.
		-	The Clock Security System (CSS) interrupt is enabled for the CAN and DFU bootloaders. Any failure (or removal) of the external clock generates system reset.
	RAM	-	8 Kbytes starting from address 0x20000000 are used by the bootloader firmware.
	System memory	-	30688 bytes starting from address 0x1FFF0000 contain the bootloader firmware.
	IWDG	-	The independent watchdog (IWDG) prescaler is configured to its maximum value. It is periodically refreshed to prevent watchdog reset (in case the hardware IWDG option was previously enabled by the user).
	Power	-	Voltage range is set to [1.62 V, 2.1 V]. In this range internal Flash write operations are allowed only in byte format (Half-Word, Word and Double-Word operations are not allowed). The voltage range can be configured in run time using bootloader commands.

Table 22. STM32F40xxx/41xxx configuration in System memory boot mode (continued)

Bootloader	Feature/Peripheral	State	Comment
USART1 bootloader	USART1	Enabled	Once initialized, the USART1 configuration is: 8 bits, even parity and 1 Stop bit.
	USART1_RX pin	Input	PA10 pin: USART1 in reception mode
	USART1_TX pin	Output	PA9 pin: USART1 in transmission mode
USART3 bootloader (on PB10/PB11)	USART3	Enabled	Once initialized, the USART3 configuration is: 8 bits, even parity and 1 Stop bit.
	USART3_RX pin	Input	PB11 pin: USART3 in reception mode
	USART3_TX pin	Output	PB10pin: USART3 in transmission mode
USART3 bootloader (on PC10/PC11)	USART3	Enabled	Once initialized, the USART3 configuration is: 8 bits, even parity and 1 Stop bit.
	USART3_RX pin	Input	PC11 pin: USART3 in reception mode
	USART3_TX pin	Output	PC10pin: USART3 in transmission mode
USART1 and USART3 bootloaders	SysTick timer	Enabled	Used to automatically detect the serial baud rate from the host for USARTx bootloaders.
CAN2 bootloader	CAN2	Enabled	Once initialized, the CAN2 configuration is: Baudrate 125 kbps, 11-bit identifier. Note: CAN1 is clocked during CAN2 bootloader execution because STM32F40xxx/41xxx CAN1 manages the communication between CAN2 and SRAM.
	CAN2_RX pin	Input	PB05 pin: CAN2 in reception mode
	CAN2_TX pin	Output	PB13pin: CAN2 in transmission mode
DFU bootloader	USB_OTG_FS	Enabled	USB OTG FS configured in Forced Device mode. USB_OTG_FS interrupt vector is enabled and used for USB DFU communications.
	USB_OTG_FS_DM pin	Input	PA11 pin: USB OTG FS DM line
	USB_OTG_FS_DP pin	Output	PA12pin: USB OTG FS DP line
CAN2 and DFU bootloaders	TIM11	Enabled	This timer is used to determine the value of the external clock frequency. Once the external clock frequency is determined, the RCC system is configured to operate at 60 MHz system clock (using PLL).

The system clock is derived from the embedded internal high-speed RC for USARTx bootloaders. This internal clock is also used for CAN and DFU (USB FS Device) but only for the selection phase. An external clock multiple of 1 MHz (between 4 and 26 MHz) is required for CAN and DFU bootloader execution after the selection phase.

11.1.2 Bootloader selection

The figure below shows the bootloader detection mechanism.

Figure 14. Bootloader V3.x selection for STM32F40xxx/41xxx devices

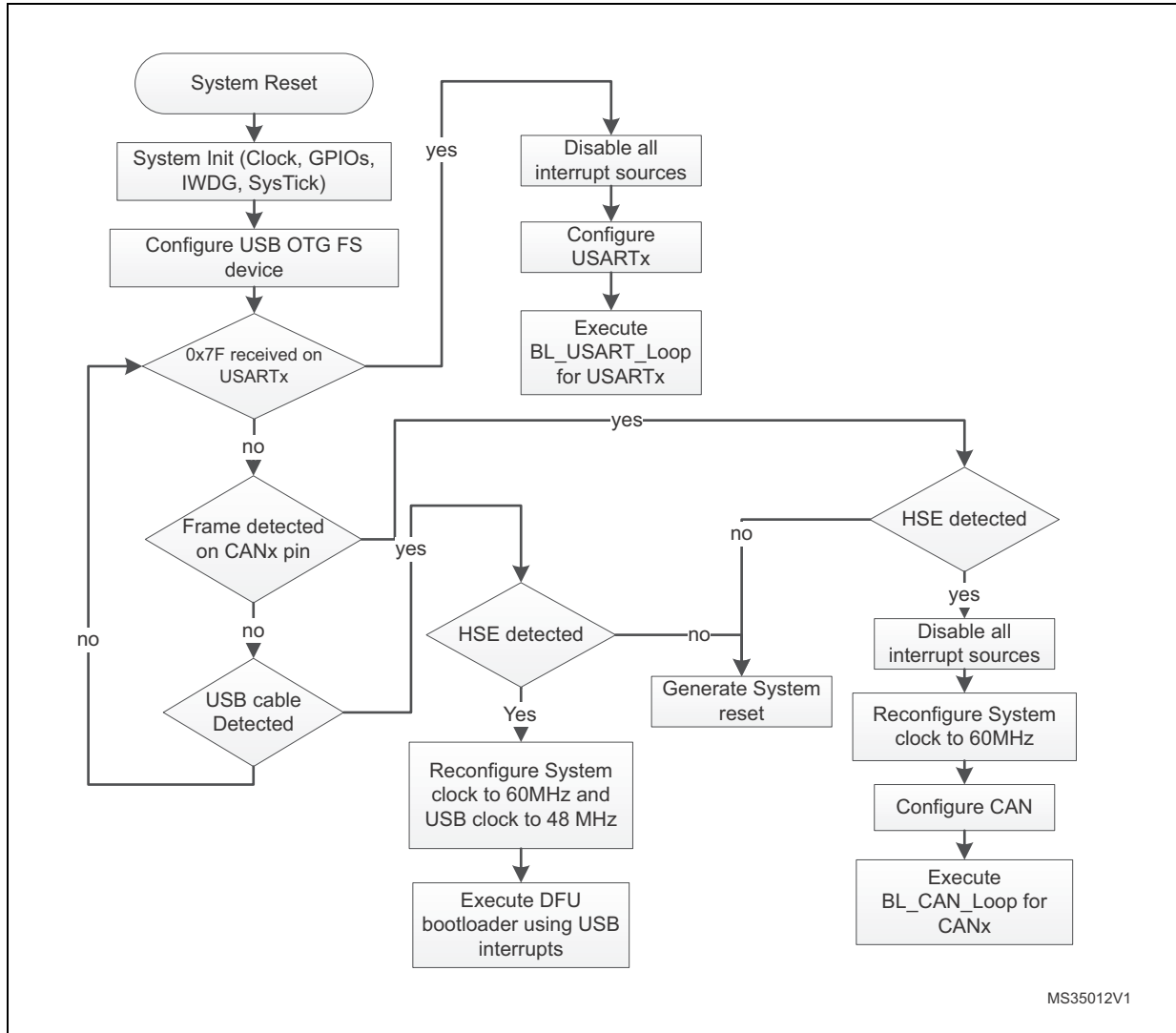

11.1.3 Bootloader version

The following table lists the STM32F40xxx/41xxx devices V3.x bootloader versions:

Table 23. STM32F40xxx/41xxx bootloader V3.x version

Bootloader version number	Description	Known limitations
V3.0	Initial bootloader version.	<ul style="list-style-type: none"> – When a Read Memory command or Write Memory command is issued with an unsupported memory address and a correct address checksum (ie. address 0x6000 0000), the command is aborted by the bootloader device, but the NACK (0x1F) is not sent to the host. As a result, the next 2 bytes (which are the number of bytes to be read/written and its checksum) are considered as a new command and its checksum⁽¹⁾. – Option bytes, OTP and Device Feature descriptors (in DFU interface) are set to “g” instead of “e” (not erasable memory areas).
V3.1	Fix V3.0 limitations. DFU interface robustness enhancement.	<ul style="list-style-type: none"> – For the USART interface, two consecutive NACKs (instead of 1 NACK) are sent when a Read Memory or Write Memory command is sent and the RDP level is active. – For the CAN interface, the Write Unprotect command is not functional. Instead you can use Write Memory command and write directly to the option bytes in order to disable the write protection.

1. If the “number of data - 1” (N-1) to be read/written is not equal to a valid command code (0x00, 0x01, 0x02, 0x11, 0x21, 0x31, 0x43, 0x44, 0x63, 0x73, 0x82 or 0x92), then the limitation is not perceived from the host since the command is NACKed anyway (as an unsupported new command).

11.2 Bootloader V9.x

11.2.1 Bootloader configuration

The STM32F40xxx/41xxx bootloader is activated by applying pattern1 (described in [Table 2: Bootloader activation patterns](#)). The following table shows the hardware resources used by this bootloader.

Table 24. STM32F40xxx/41xxx configuration in System memory boot mode

Bootloader	Feature/Peripheral	State	Comment
Common to all bootloaders	RCC	HSI enabled	The system clock is equal to 60 MHz using the PLL. The HSI clock source is used at startup (interface detection phase) and when USART or SPI or I2C interfaces are selected (once CAN or DFUbootloader is selected, the clock source will be derived from external crystal).
		HSE enabled	The system clock is equal to 60 MHz. The HSE clock source is used only when the CAN or the DFU (USB FS Device) interfaces are selected. The external clock must provide a frequency multiple of 1 MHz and ranging from 4 MHz to 26 MHz.
		-	The Clock Security System (CSS) interrupt is enabled for the CAN and DFU bootloaders. Any failure (or removal) of the external clock generates system reset.
	RAM	-	12 Kbytes starting from address 0x20000000 are used by the bootloader firmware
	System memory	-	30424 bytes starting from address 0x1FFF0000, contain the bootloader firmware
	IWDG	-	The independent watchdog (IWDG) prescaler is configured to its maximum value. It is periodically refreshed to prevent watchdog reset (in case the hardware IWDG option was previously enabled by the user).
	Power	-	Voltage range is set to [1.62 V, 2.1 V]. In this range internal Flash write operations are allowed only in byte format (Half-Word, Word and Double-Word operations are not allowed). The voltage range can be configured in run time using bootloader commands.

Table 24. STM32F40xxx/41xxx configuration in System memory boot mode (continued)

Bootloader	Feature/Peripheral	State	Comment
USART1 bootloader	USART1	Enabled	Once initialized the USART1 configuration is: 8-bits, even parity and 1 Stop bit
	USART1_RX pin	Input	PA10 pin: USART1 in reception mode
	USART1_TX pin	Output	PA9 pin: USART1 in transmission mode
USART3 bootloader (on PB10/PB11)	USART3	Enabled	Once initialized the USART3 configuration is: 8-bits, even parity and 1 Stop bit
	USART3_RX pin	Input	PB11 pin: USART3 in reception mode
	USART3_TX pin	Output	PB10 pin: USART3 in transmission mode
USART3 bootloader (on PC10/PC11)	USART3	Enabled	Once initialized the USART3 configuration is: 8-bits, even parity and 1 Stop bit
	USART3_RX pin	Input	PC11 pin: USART3 in reception mode
	USART3_TX pin	Output	PC10 pin: USART3 in transmission mode
USART1 and USART3 bootloaders	SysTick timer	Enabled	Used to automatically detect the serial baud rate from the host for USARTx bootloaders.
CAN2 bootloader	CAN2	Enabled	Once initialized the CAN2 configuration is: Baudrate 125 kbps, 11-bit identifier. Note: CAN1 is clocked during CAN2 bootloader execution because STM32F40xxx/41xxxCAN1 manages the communication between CAN2 and SRAM.
	CAN2_RX pin	Input	PB05 pin: CAN2 in reception mode
	CAN2_TX pin	Output	PB13 pin: CAN2 in transmission mode
I2C1 bootloader	I2C1	Enabled	The I2C1 configuration is: I2C speed: up to 400 KHz, 7-bit address, slave mode, slave address: 0x74, analog filter ON.
	I2C1_SCL pin	Input/output	PB6 pin: clock line is used in open-drain mode.
	I2C1_SDA pin	Input/output	PB7 pin: data line is used in open-drain mode.
I2C2 bootloader	I2C2	Enabled	The I2C2 configuration is: I2C speed: up to 400 KHz, 7-bit address, slave mode, slave address: 0x74, analog filter ON.
	I2C2_SCL pin	Input/output	PF0 pin: clock line is used in open-drain mode.
	I2C2_SDA pin	Input/output	PF1 pin: data line is used in open-drain mode.

Table 24. STM32F40xxx/41xxx configuration in System memory boot mode (continued)

Bootloader	Feature/Peripheral	State	Comment
I2C3 bootloader	I2C3	Enabled	The I2C3 configuration is: I2C speed: up to 400 KHz, 7-bit address, slave mode, slave address: 0x74, analog filter ON.
	I2C3_SCL pin	Input/output	PA8 pin: clock line is used in open-drain mode.
	I2C3_SDA pin	Input/output	PC9 pin: data line is used in open-drain mode.
SPI1 bootloader	SPI1	Enabled	The SPI1 configuration is: Slave mode, Full Duplex, 8-bit MSB, Speed up to 8MHz, Polarity: CPHA Low, NSS hardware.
	SPI1_MOSI pin	Input	PA7 pin: Slave data Input line, used in Push-pull pull-down mode
	SPI1_MISO pin	Output	PA6 pin: Slave data output line, used in Push-pull pull-down mode
	SPI1_SCK pin	Input	PA5 pin: Slave clock line, used in Push-pull pull-down mode
	SPI1_NSS pin	Input	PA4 pin: Slave Chip Select pin used in Push-pull pull-up mode.
SPI2 bootloader	SPI2	Enabled	The SPI2 configuration is: Slave mode, Full Duplex, 8-bit MSB, Speed up to 8MHz, Polarity: CPHA Low, NSS hardware.
	SPI2_MOSI pin	Input	PI0 pin: Slave data Input line, used in Push-pull pull-down mode
	SPI2_MISO pin	Output	PI1 pin: Slave data output line, used in Push-pull pull-down mode
	SPI2_SCK pin	Input	PI2 pin: Slave clock line, used in Push-pull pull-down mode
	SPI2_NSS pin	Input	PI3 pin: Slave Chip Select pin used in Push-pull pull-up mode.

Table 24. STM32F40xxx/41xxx configuration in System memory boot mode (continued)

Bootloader	Feature/Peripheral	State	Comment
DFU bootloader	USB_OTG_FS	Enabled	USB OTG FS configured in Forced Device mode. USB_OTG_FS interrupt vector is enabled and used for USB DFU communications.
	USB_OTG_FS_DM pin	Input	PA11 pin: USB OTG FS DM line
	USB_OTG_FS_DP pin	Output	PA12pin: USB OTG FS DP line
	TIM11	Enabled	This timer is used to determine the value of the external clock frequency. Once the external clock frequency is determined, the RCC system is configured to operate at 60 MHz system clock (using PLL).

The system clock is derived from the embedded internal high-speed RC for USARTx, I2Cx and SPIx bootloaders. This internal clock is also used for CAN and DFU (USB FS Device) but only for the selection phase. An external clock multiple of 1 MHz (between 4 and 26 MHz) is required for CAN and DFU bootloader execution after the selection phase.

11.2.2 Bootloader selection

The figures below shows the bootloader selection mechanism.

Figure 15. Bootloader V9.x selection for STM32F40xxx/41xxx

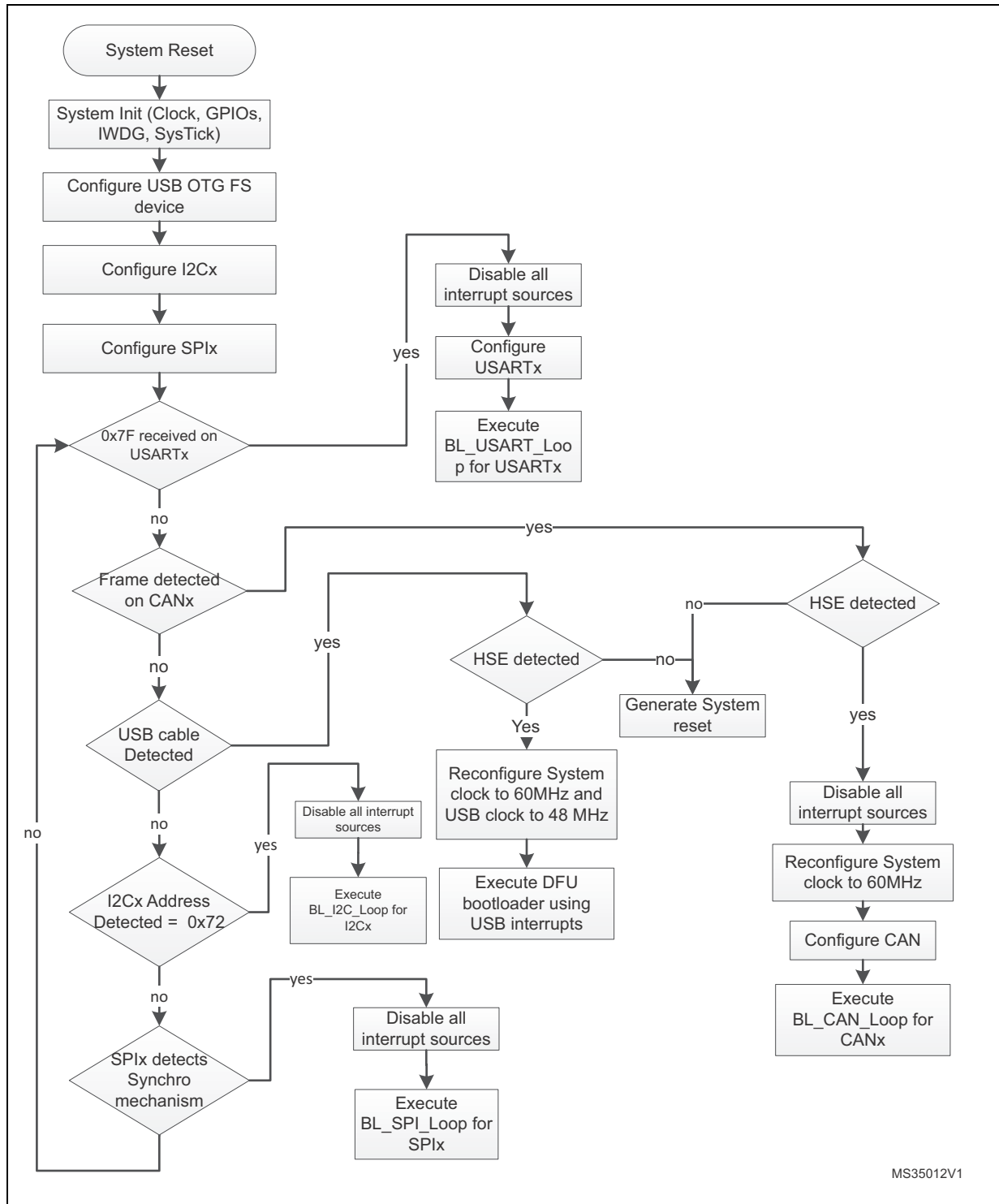

MS35012V1

11.2.3 Bootloader version

The following table lists the STM32F40xxx/41xxx devices V9.x bootloader versions.

Table 25. STM32F40xxx/41xxx bootloader V9.x version

Bootloader version number	Description	Known limitations
V9.0	<p>This bootloader is an updated version of Bootloader v3.1.</p> <p>This new version of bootloader supports I2C1, I2C2, I2C3, SPI1 and SPI2 interfaces.</p> <p>The RAM used by this bootloader is increased from 8Kb to 12Kb.</p> <p>The ID of this bootloader is 0x90.</p> <p>The connection time is increased.</p>	<ul style="list-style-type: none"> – For the USART interface, two consecutive NACKs (instead of 1 NACK) are sent when a Read Memory or Write Memory command is sent and the RDP level is active. – For the CAN interface, the Write Unprotect command is not functional. Instead you can use Write Memory command and write directly to the option bytes in order to disable the write protection.

12 STM32F051xx devices bootloader

12.1 Bootloader configuration

The STM32F051xx bootloader is activated by applying pattern2 (described in [Table 2: Bootloader activation patterns](#)). The following table shows the hardware resources used by this bootloader.

Table 26. STM32F051xx configuration in System memory boot mode

Bootloader	Feature/Peripheral	State	Comment
Common to all bootloaders	Clock Source	HSI Enabled	The System clock is equal to 24 MHz (using PLL clocked by HSI). 1 Flash Wait State.
	RAM	-	2 Kbytes starting from address 0x20000000 are used by the bootloader firmware.
	System memory	-	3 Kbytes starting from address 0x1FFFEC00, contain the bootloader firmware.
	IWDG	-	The independent watchdog (IWDG) prescaler is configured to its maximum value. It is periodically refreshed to prevent watchdog reset in case the hardware IWDG option was previously enabled by the user.
USART1 bootloader	USART1	Enabled	Once initialized, the USART1 configuration is 8 bits, even parity and 1 Stop bit.
	USART1_RX pin	Input	PA10 pin: USART1 in reception mode.
	USART1_TX pin	Output	PA9 pin: USART1 in transmission mode.
USART2 bootloader	USART2	Enabled	Once initialized, the USART2 configuration is 8 bits, even parity and 1 Stop bit.
	USART2_RX pin	Input	PA15 pin: USART2 in reception mode.
	USART2_TX pin	Output	PA14 pin: USART2 in transmission mode.
USART1 and USART2 bootloaders	SysTick timer	Enabled	Used to automatically detect the serial baud rate from the host.

The system clock is derived from the embedded internal high-speed RC, no external quartz is required for the bootloader execution.

Note: After the STM32F051xx devices have booted in bootloader mode, the serial wire debug (SWD) communication is no more possible until the system is reset, because SWD uses PA14 pin (SWCLK) which is already used by the bootloader (USART2_TX).

12.2 Bootloader selection

The figure below shows the bootloader detection mechanism.

Figure 16. Bootloader selection for STM32F051xx devices

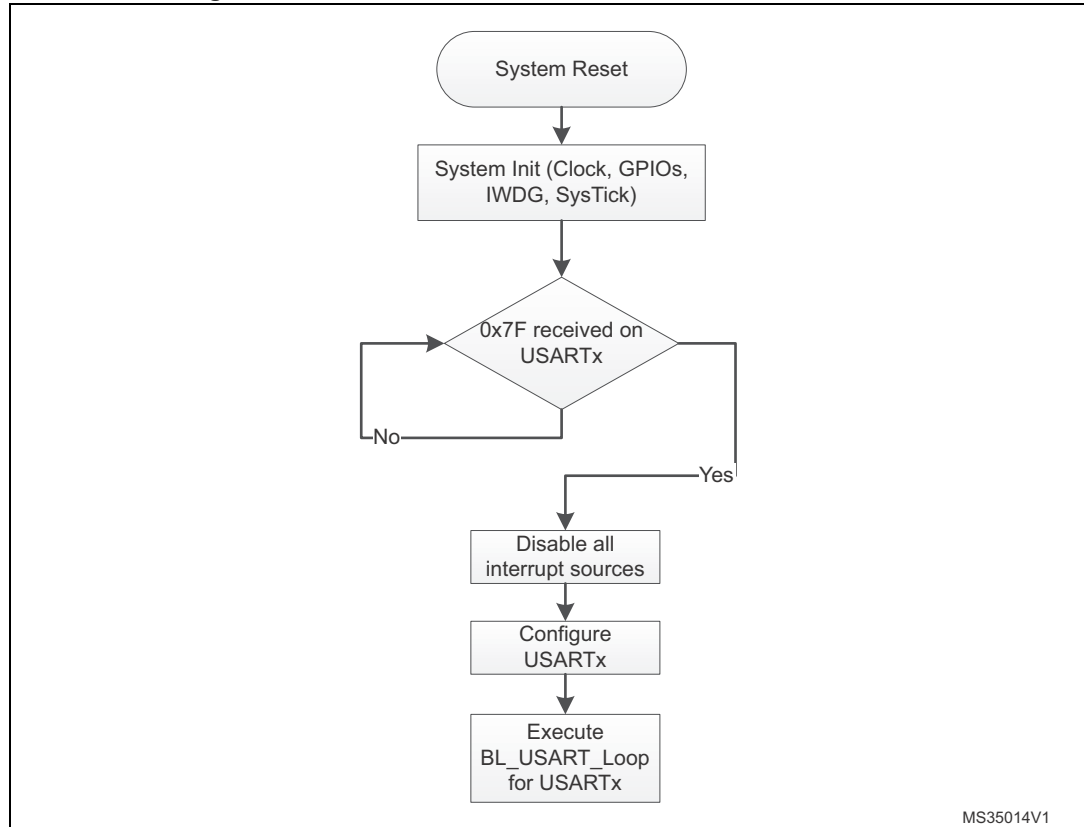

12.3 Bootloader version

The following table lists the STM32F051xx bootloader versions.

Table 27. STM32F051xx bootloader versions

Bootloader version number	Description	Known limitations
V2.1	Initial bootloader version	When the user application configures a value of HSI TRIM bits (in RCC_CR register) and then jumps to the bootloader, the HSITRIM value is reset to its default value (0) at bootloader startup. For the USART interface, two consecutive NACKs instead of 1 NACK are sent when a Read Memory or Write Memory command is sent and the RDP level is active.

13 STM32F031xx devices bootloader

13.1 Bootloader configuration

The STM32F031xx bootloader is activated by applying pattern2 (described in [Table 2: Bootloader activation patterns](#)). The following table shows the hardware resources used by this bootloader.

Table 28. STM32F031xx configuration in System memory boot mode

Bootloader	Feature/Peripheral	State	Comment
Common to all bootloaders	Clock Source	HSI Enabled	The System clock is equal to 24 MHz (using PLL clocked by HSI). 1 Flash Wait State.
	RAM	-	2 Kbytes starting from address 0x20000000 are used by the bootloader firmware.
	System memory	-	3 Kbytes starting from address 0x1FFFEC00 contain the bootloader firmware.
	IWDG	-	The independent watchdog (IWDG) prescaler is configured to its maximum value. It is periodically refreshed to prevent watchdog reset in case the hardware IWDG option was previously enabled by the user.
USART1 bootloader (on PA10/PA9)	USART1	Enabled	Once initialized, the USART1 configuration is 8 bits, even parity and 1 Stop bit.
	USART1_RX pin	Input	PA10 pin: USART1 in reception mode.
	USART1_TX pin	Output	PA9 pin: USART1 in transmission mode.
USART1 bootloader (on PA14/PA15)	USART1	Enabled	Once initialized, the USART1 configuration is 8 bits, even parity and 1 Stop bit.
	USART1_RX pin	Input	PA15 pin: USART1 in reception mode.
	USART1_TX pin	Output	PA14 pin: USART1 in transmission mode.
USART1 bootloaders	SysTick timer	Enabled	Used to automatically detect the serial baud rate from the host.

The system clock is derived from the embedded internal high-speed RC, no external quartz is required for the bootloader execution.

Note: After the STM32F031xx devices has booted in bootloader mode, serial wire debug (SWD) communication is no longer possible until the system is reset. This is because the SWD uses the PA14 pin (SWCLK) which is already used by the bootloader (USART1_TX).

13.2 Bootloader selection

The figure below shows the bootloader detection mechanism.

Figure 17. Bootloader selection for STM32F031xx devices

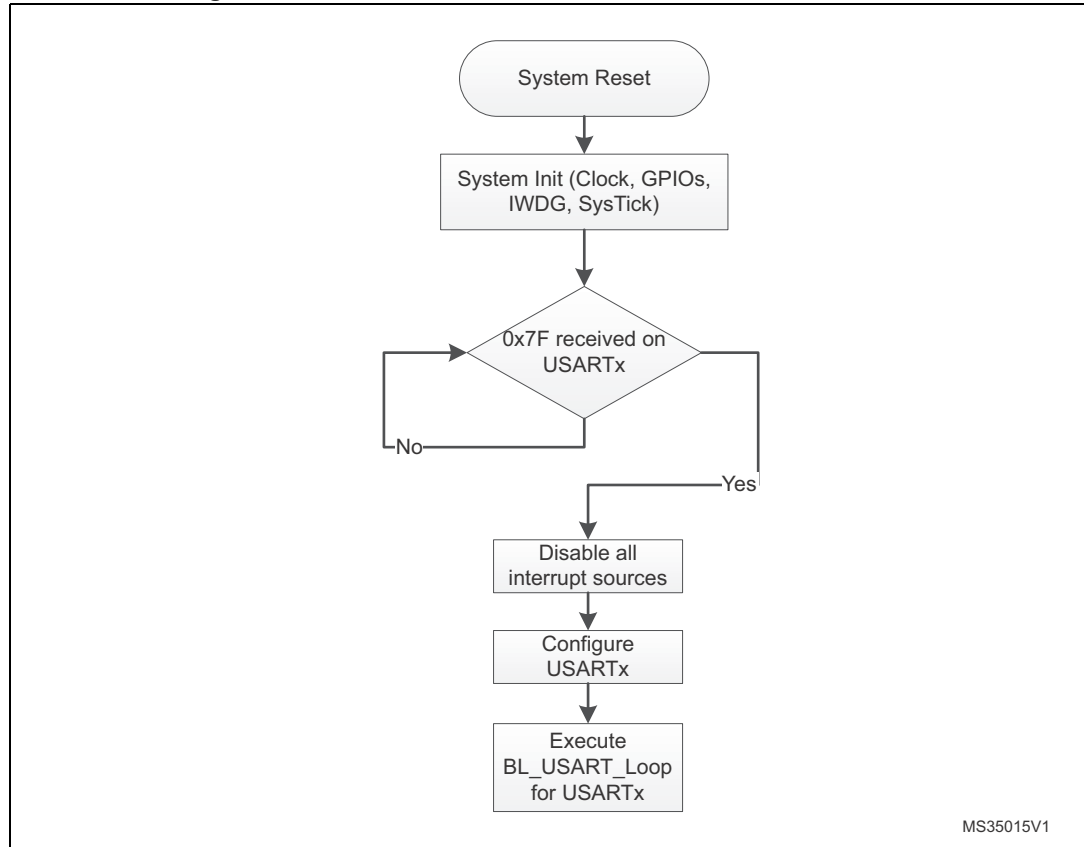

13.3 Bootloader version

The following table lists the STM32F031xx devices bootloader versions.

Table 29. STM32F031xx bootloader versions

Bootloader version number	Description	Known limitations
V1.0	Initial bootloader version	For the USART interface, two consecutive NACKs instead of 1 NACK are sent when a Read Memory or Write Memory command is sent and the RDP level is active.

14 STM32F373xx devices bootloader

14.1 Bootloader configuration

The STM32F373xx bootloader is activated by applying pattern2 (described in [Table 2: Bootloader activation patterns](#)). The following table shows the hardware resources used by this bootloader.

Table 30. STM32F373xx configuration in System memory boot mode

Bootloader	Feature/Peripheral	State	Comment
Common to all bootloaders	RCC	HSI enabled	At startup, the system clock frequency is configured to 48 MHz using the HSI. If an external clock (HSE) is not present, the system is kept clocked from the HSI.
		HSE enabled	The external clock can be used for all bootloader interfaces and should have one the following values 24, 18,16, 12, 9, 8, 6, 4, 3 MHz. The PLL is used to generate the USB 48 MHz clock and the 48 MHz clock for the system clock.
		-	The clock security system (CSS) interrupt is enabled for the DFU bootloader. Any failure (or removal) of the external clock generates system reset.
	IWDG	-	The independent watchdog (IWDG) prescaler is configured to its maximum value and is periodically refreshed to prevent watchdog reset (in case the hardware IWDG option was previously enabled by the user).
	System memory	-	8 Kbytes starting from address 0x1FFFD800. This area contains the bootloader firmware
	RAM	-	5 Kbytes starting from address 0x20000000 are used by the bootloader firmware.
USART1 and USART2 bootloaders	SysTick timer	Enabled	Used to automatically detect the serial baud rate from the host for USARTx bootloader.
USART1 bootloader	USART1	Enabled	Once initialized, the USART1 configuration is: 8 bits, even parity and 1 Stop bit.
	USART1_RX pin	Input	PA10 pin: USART1 in reception mode
	USART1_TX pin	Output	PA9 pin: USART1 in transmission mode

Table 30. STM32F373xx configuration in System memory boot mode (continued)

Bootloader	Feature/Peripheral	State	Comment
USART2 bootloader	USART2	Enabled	Once initialized, the USART2 configuration is: 8 bits, even parity and 1 Stop bit. The USART2 uses its remapped pins.
	USART2_RX pin	Input	PD6 pin: USART2 in reception mode
	USART2_TX pin	Output	PD5 pin: USART2 in transmission mode
DFU bootloader	USB_DM pin	Alternate function, automatically controlled by the USB	PA11: USB Send-Receive data line
	USB_DP pin		PA12: USB Send-Receive data line An external pull-up resistor 1.5 Kohm must be connected to USB_DP pin.
	Interrupts	Enabled	USB Low Priority interrupt vector is enabled and used for USB DFU communication.

The bootloader has two case of operation depending on the presence of the external clock (HSE) at bootloader startup:

- If HSE is present and has a value of 24, 18, 16, 12, 9, 8, 6, 4 or 3 MHz, the system clock is configured to 48 Mhz with HSE as clock source. The DFU interface, USART1 and USART2 are functional and can be used to communicate with the bootloader device.
- If HSE is not present, the HSI is kept as default clock source and only USART1 and USART2 are functional.

Note: The external clock (HSE) must be kept if it's connected at bootloader startup because it will be used as system clock source.

14.2 Bootloader selection

The figure below shows the bootloader detection mechanism.

Figure 18. Bootloader selection for STM32F373xx devices

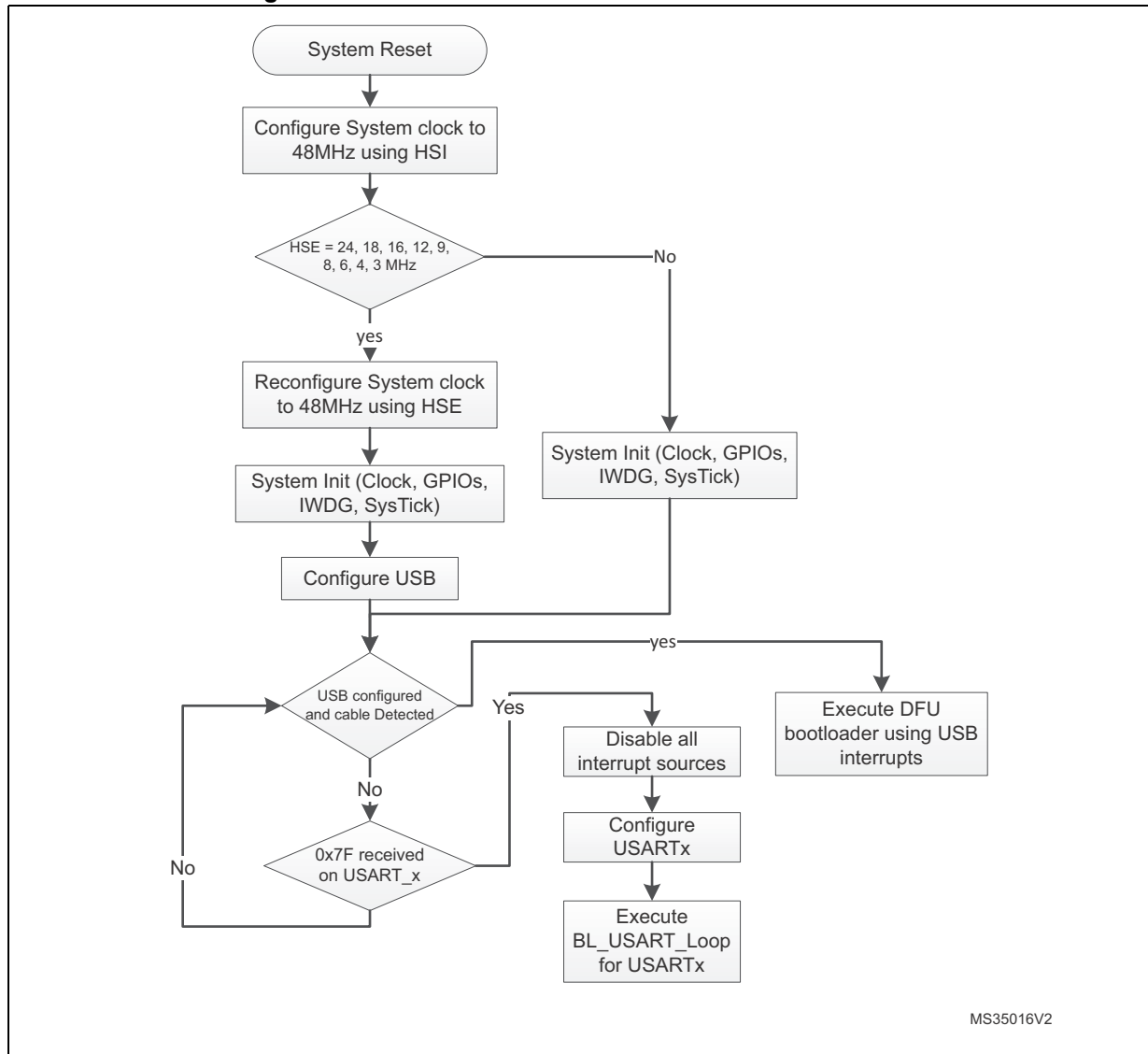

MS35016V2

14.3 Bootloader version

The following table lists the STM32F373xx devices bootloader versions.

Table 31. STM32F373xx bootloader versions

Bootloader version number	Description	Known limitations
V4.1	Initial bootloader version	None

15 STM32F302xB(C)/303xB(C) devices bootloader

15.1 Bootloader configuration

The STM32F302xB(C)/303xB(C) bootloader is activated by applying pattern2 (described in [Table 2: Bootloader activation patterns](#)). The following table shows the hardware resources used by this bootloader.

Table 32. STM32F302xB(C)/303xB(C) configuration in System memory boot mode

Bootloader	Feature/Peripheral	State	Comment
Common to all bootloaders	RCC	HSI enabled	At startup, the system clock frequency is configured to 48 MHz using the HSI. If an external clock (HSE) is not present, the system is kept clocked from the HSI.
		HSE enabled	The external clock can be used for all bootloader interfaces and should have one the following values 24, 18,16, 12, 9, 8, 6, 4, 3 MHz. The PLL is used to generate the USB 48 MHz clock and the 48 MHz clock for the system clock.
		-	The clock security system (CSS) interrupt is enabled for the DFU bootloader. Any failure (or removal) of the external clock generates system reset.
	IWDG	-	The independent watchdog (IWDG) prescaler is configured to its maximum value and is periodically refreshed to prevent watchdog reset (in case the hardware IWDG option was previously enabled by the user).
	System memory	-	8 Kbytes starting from address 0x1FFFD800. This area contains the bootloader firmware
	RAM	-	5 Kbytes starting from address 0x20000000 are used by the bootloader firmware.
USART1 and USART2 bootloaders	SysTick timer	Enabled	Used to automatically detect the serial baud rate from the host for USARTx bootloader.
USART1 bootloader	USART1	Enabled	Once initialized, the USART1 configuration is: 8 bits, even parity and 1 Stop bit.
	USART1_RX pin	Input	PA10 pin: USART1 in reception mode
	USART1_TX pin	Output	PA9 pin: USART1 in transmission mode

Table 32. STM32F302xB(C)/303xB(C) configuration in System memory boot mode (continued)

Bootloader	Feature/Peripheral	State	Comment
USART1 bootloader	USART2	Enabled	Once initialized, the USART2 configuration is: 8 bits, even parity and 1 Stop bit. The USART2 uses its remapped pins.
	USART2_RX pin	Input	PD6 pin: USART2 in reception mode
	USART2_TX pin	Output	PD5 pin: USART2 in transmission mode
DFU bootloader	USB_DM pin	Alternate function, automatically controlled by the USB	PA11: USB Send-Receive data line
	USB_DP pin		PA12: USB Send-Receive data line An external pull-up resistor 1.5 Kohm must be connected to USB_DP pin.
	Interrupts	Enabled	USB Low Priority interrupt vector is enabled and used for USB DFU communication.

The bootloader has two case of operation depending on the presence of the external clock (HSE) at bootloader startup:

- If HSE is present and has a value of 24, 18, 16, 12, 9, 8, 6, 4 or 3 MHz, the system clock is configured to 48 Mhz with HSE as clock source. The DFU interface, USART1 and USART2 are functional and can be used to communicate with the bootloader device.
- If HSE is not present, the HSI is kept as default clock source and only USART1 and USART2 are functional.

The external clock (HSE) must be kept if it's connected at bootloader startup because it will be used as system clock source.

15.2 Bootloader selection

The figure below shows the bootloader detection mechanism.

Figure 19. Bootloader selection for STM32F302xB(C)/303xB(C) devices

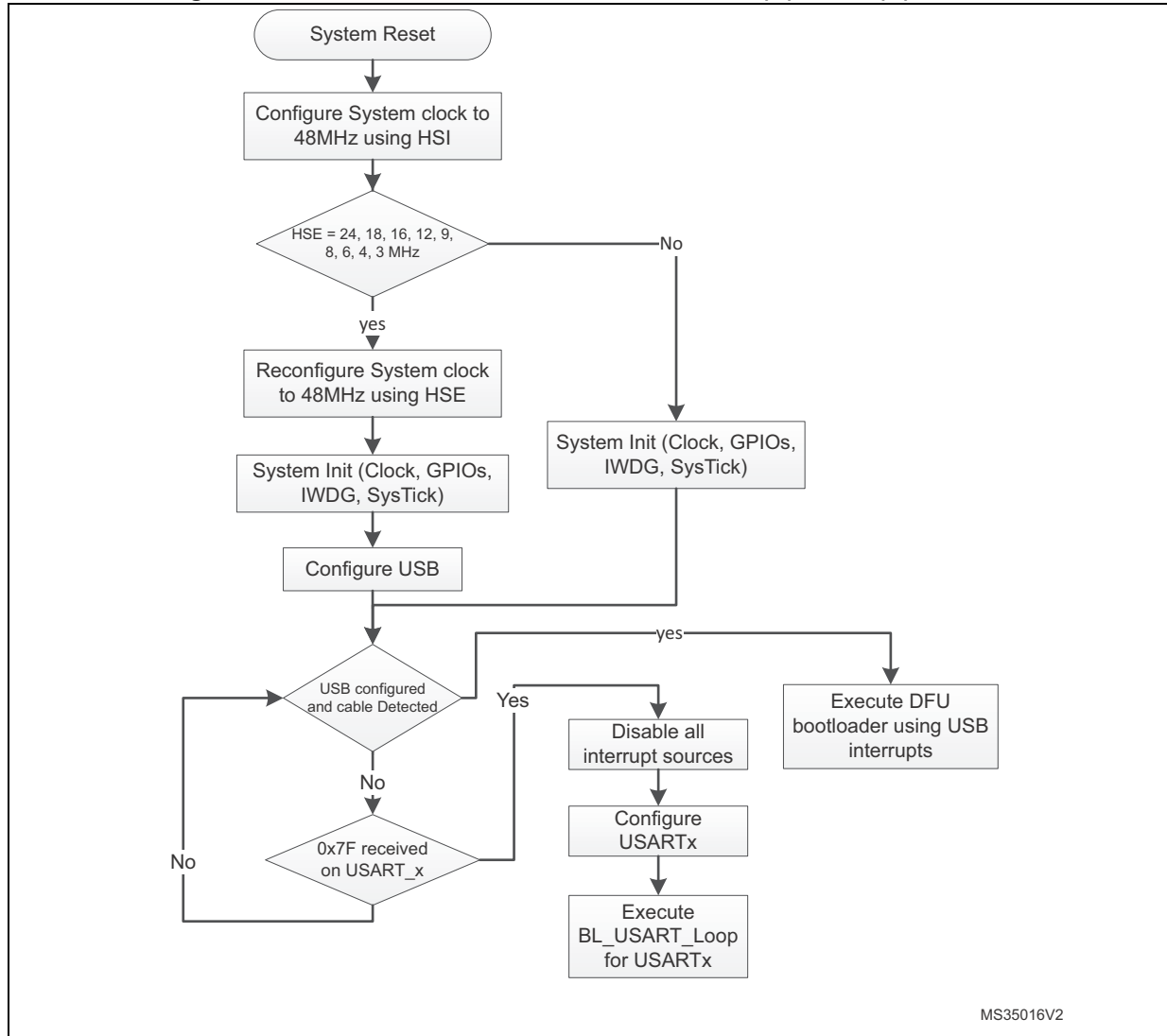

15.3 Bootloader version

The following table lists the STM32F302xB(C)/303xB(C) devices bootloader versions.

Table 33. STM32F302xB(C)/303xB(C) bootloader versions

Bootloader version number	Description	Known limitations
V4.1	Initial bootloader version	None

16 STM32F378xx devices bootloader

16.1 Bootloader configuration

The STM32F378xx bootloader is activated by applying pattern2 (described in [Table 2: Bootloader activation patterns](#)). The following table shows the hardware resources used by this bootloader.

Table 34. STM32F378xx configuration in System memory boot mode

Bootloader	Feature/Peripheral	State	Comment
Common to all bootloaders	RCC	HSI enabled	The system clock frequency is 8 MHz using the HSI.
	IWDG	-	The independent watchdog (IWDG) prescaler is configured to its maximum value and is periodically refreshed to prevent watchdog reset (in case the hardware IWDG option was previously enabled by the user). Window feature is disabled.
	System memory	-	8 Kbytes starting from address 0x1FFFD800. This area contains the bootloader firmware
	RAM	-	4 Kbytes starting from address 0x20000000 are used by the bootloader firmware.
USART1 bootloader	USART1	Enabled	Once initialized, the USART1 configuration is: 8 bits, even parity and 1 Stop bit
	USART1_RX pin	Input	PA10 pin: USART1 in reception mode.
	USART1_TX pin	Output	PA9 pin: USART1 in transmission mode.
USART2 bootloader	USART2	Enabled	Once initialized, the USART2 configuration is: 8 bits, even parity and 1 Stop bit. The USART2 uses its remapped pins.
	USART2_RX pin	Input	PD6 pin: USART2 in reception mode.
	USART2_TX pin	Output	PD5 pin: USART2 in transmission mode.
USART1 and USART2 bootloaders	SysTick timer	Enabled	Used to automatically detect the serial baud rate from the host for USARTx bootloader.
I2C1 bootloader	I2C1	Enabled	The I2C1 configuration is: I2C speed: up to 400 KHz, 7-bit address, slave mode, slave address: 0x6E, analog filter ON.
	I2C1_SCL pin	Input/ Output	PB6 pin: clock line is used in open-drain mode.
	I2C1_SDA pin	Input/ Output	PB7 pin: data line is used in open-drain mode.

The system clock is derived from the embedded internal high-speed RC, no external quartz is required for the bootloader execution.

16.2 Bootloader selection

The figure below shows the bootloader detection mechanism.

Figure 20. Bootloader selection for STM32F378xx devices

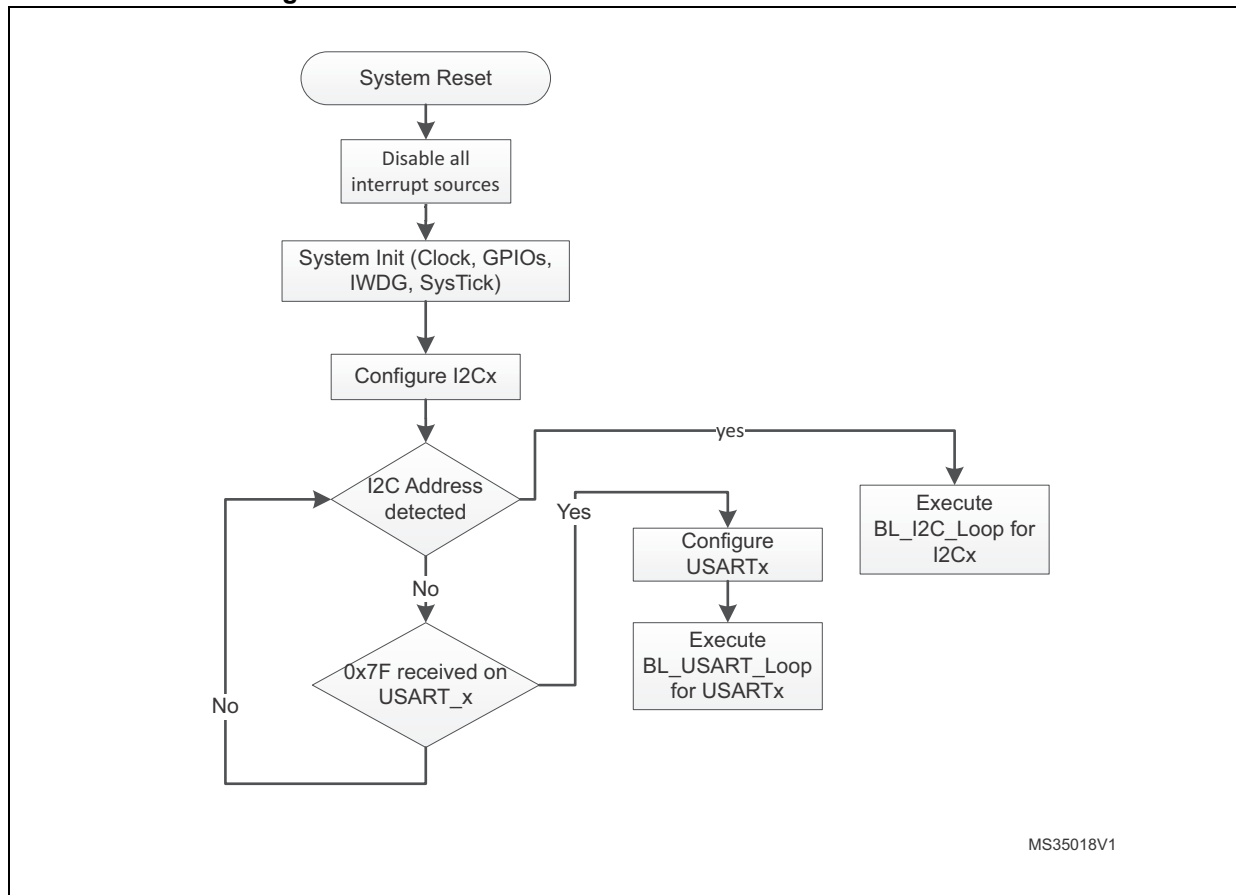

16.3 Bootloader version

The following table lists the STM32F378xx devices bootloader versions.

Table 35. STM32F378xx bootloader versions

Bootloader version number	Description	Known limitations
V5.0	Initial bootloader version	For USART1 and USART2 interfaces, the maximum baudrate supported by the bootloader is 57600 baud.

17 STM32F358xx devices bootloader

17.1 Bootloader configuration

The STM32F358xx bootloader is activated by applying pattern2 (described in [Table 2: Bootloader activation patterns](#)). The following table shows the hardware resources used by this bootloader.

Table 36. STM32F358xx configuration in System memory boot mode

Bootloader	Feature/Peripheral	State	Comment
Common to all bootloaders	RCC	HSI enabled	The system clock frequency is 8 MHz using the HSI.
	IWDG	-	The independent watchdog (IWDG) prescaler is configured to its maximum value and is periodically refreshed to prevent watchdog reset (in case the hardware IWDG option was previously enabled by the user). Window feature is disabled.
	System memory	-	8 Kbytes starting from address 0x1FFFD800. This area contains the bootloader firmware.
	RAM	-	5 Kbytes starting from address 0x20000000 are used by the bootloader firmware.
USART1 bootloader	USART1	Enabled	Once initialized, the USART1 configuration is: 8 bits, even parity and 1 Stop bit.
	USART1_RX pin	Input	PA10 pin: USART1 in reception mode.
	USART1_TX pin	Output	PA9 pin: USART1 in transmission mode.
USART2 bootloader	USART2	Enabled	Once initialized, the USART2 configuration is: 8 bits, even parity and 1 Stop bit. The USART2 uses its remapped pins.
	USART2_RX pin	Input	PD6 pin: USART2 in reception mode.
	USART2_TX pin	Output	PD5 pin: USART2 in transmission mode.
USART1 and USART2 bootloaders	SysTick timer	Enabled	Used to automatically detect the serial baud rate from the host for USARTx bootloader.
I2C1 bootloader	I2C1	Enabled	The I2C1 configuration is: I2C speed: up to 400 KHz, 7-bit address, slave mode, slave address: 0x6E, analog filter ON.
	I2C1_SCL pin	Input/ Output	PB6 pin: clock line is used in open-drain mode.
	I2C1_SDA pin	Input/ Output	PB7 pin: data line is used in open-drain mode.

The system clock is derived from the embedded internal high-speed RC, no external quartz is required for the bootloader execution.

17.2 Bootloader selection

The figure below shows the bootloader detection mechanism.

Figure 21. Bootloader selection for STM32F358xx devices

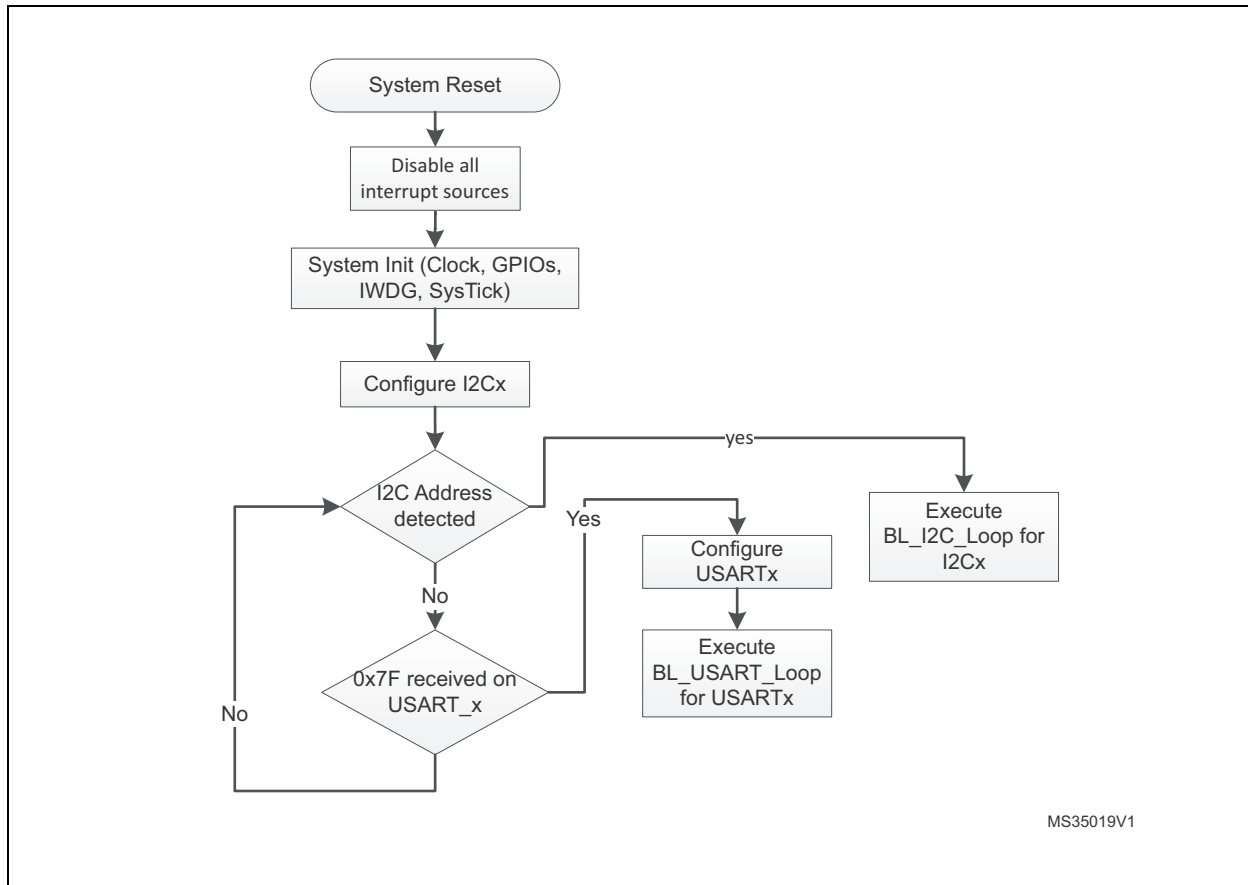

17.3 Bootloader version

The following table lists the STM32F358xx devices bootloader versions.

Table 37. STM32F358xx bootloader versions

Bootloader version number	Description	Known limitations
V5.0	Initial bootloader version	For USART1 and USART2 interfaces, the maximum baudrate supported by the bootloader is 57600 baud.

18 STM32F427xx/437xx devices bootloader

18.1 Bootloader configuration

The STM32F427xx/437xx bootloader is activated by applying pattern1 (described in [Table 2: Bootloader activation patterns](#)). The following table shows the hardware resources used by this bootloader.

Table 38. STM32F427xx/437xx configuration in System memory boot mode

Bootloader	Feature/Peripheral	State	Comment
Common to all bootloaders	RCC	HSI enabled	The system clock is equal to 24 MHz using the PLL. The HSI clock source is used at startup (interface detection phase) and when USARTx interfaces are selected (once CAN or DFU bootloader is selected, the clock source will be derived from external crystal).
		HSE enabled	The system clock is equal to 60 MHz. The HSE clock source is used only when the CAN or the DFU (USB FS Device) interfaces are selected. The external clock must provide a frequency multiple of 1 MHz and ranging from 4 MHz to 26 MHz.
		-	The Clock Security System (CSS) interrupt is enabled for the CAN and DFU bootloaders. Any failure (or removal) of the external clock generates system reset.
	RAM	-	8 Kbytes starting from address 0x20000000 are used by the bootloader firmware
	System memory	-	30424 bytes starting from address 0x1FFF0000, contain the bootloader firmware
	IWDG	-	The independent watchdog (IWDG) prescaler is configured to its maximum value. It is periodically refreshed to prevent watchdog reset (in case the hardware IWDG option was previously enabled by the user).
	Power	-	Voltage range is set to [1.62 V, 2.1 V]. In this range internal Flash write operations are allowed only in byte format (Half-Word, Word and Double-Word operations are not allowed). The voltage range can be configured in run time using bootloader commands.

Table 38. STM32F427xx/437xx configuration in System memory boot mode (continued)

Bootloader	Feature/Peripheral	State	Comment
USART1 bootloader	USART1	Enabled	Once initialized, the USART1 configuration is: 8 bits, even parity and 1 Stop bit.
	USART1_RX pin	Input	PA10 pin: USART1 in reception mode
	USART1_TX pin	Output	PA9 pin: USART1 in transmission mode
USART3 bootloader (on PB10/PB11)	USART3	Enabled	Once initialized, the USART3 configuration is: 8 bits, even parity and 1 Stop bit.
	USART3_RX pin	Input	PB11 pin: USART3 in reception mode
	USART3_TX pin	Output	PB10pin: USART3 in transmission mode
USART3 bootloader (on PC10/PC11)	USART3	Enabled	Once initialized, the USART3 configuration is: 8 bits, even parity and 1 Stop bit.
	USART3_RX pin	Input	PC11 pin: USART3 in reception mode
	USART3_TX pin	Output	PC10pin: USART3 in transmission mode
USART1 and USART3 bootloaders	SysTick timer	Enabled	Used to automatically detect the serial baud rate from the host for USARTx bootloaders.
CAN2 bootloader	CAN2	Enabled	Once initialized, the CAN2 configuration is: Baudrate 125 kbps, 11-bit identifier. Note: CAN1 is clocked during CAN2 bootloader execution because STM32F4xx CAN1 manages the communication between CAN2 and SRAM.
	CAN2_RX pin	Input	PB05 pin: CAN2 in reception mode
	CAN2_TX pin	Output	PB13pin: CAN2 in transmission mode
DFU bootloader	USB_OTG_FS	Enabled	USB OTG FS configured in Forced Device mode. USB_OTG_FS interrupt vector is enabled and used for USB DFU communications.
	USB_OTG_FS_DM pin	Input	PA11 pin: USB OTG FS DM line
	USB_OTG_FS_DP pin	Output	PA12pin: USB OTG FS DP line
	TIM11	Enabled	This timer is used to determine the value of the external clock frequency. Once the external clock frequency is determined, the RCC system is configured to operate at 60 MHz system clock (using PLL).

The system clock is derived from the embedded internal high-speed RC for USARTx bootloaders. This internal clock is also used for CAN and DFU (USB FS Device) but only for the selection phase. An external clock multiple of 1 MHz (between 4 and 26 MHz) is required for CAN and DFU bootloader execution after the selection phase.

18.2 Bootloader selection

The figure below shows the bootloader detection mechanism:

Figure 22. Bootloader selection for STM32F427xx/437xx devices

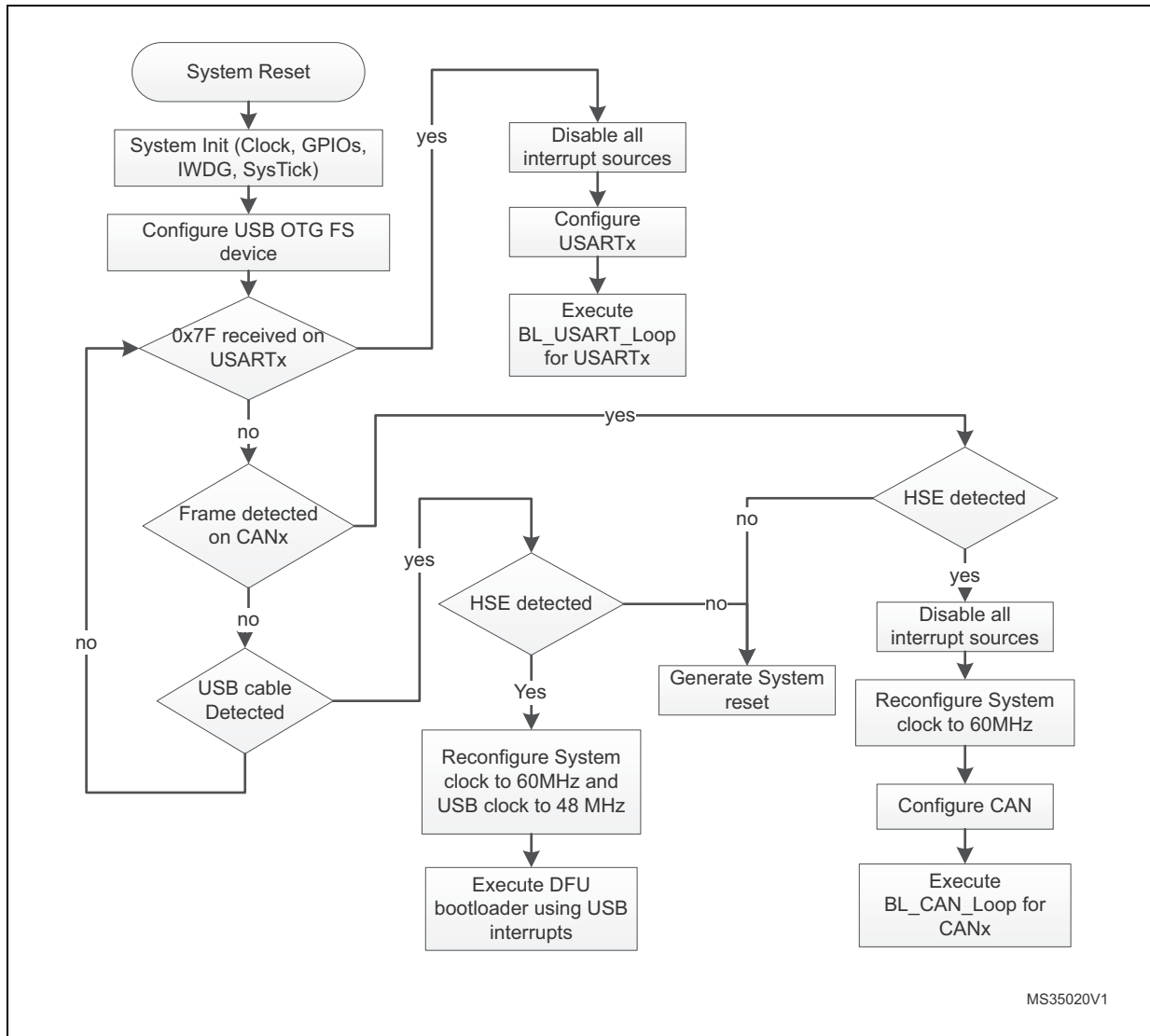

MS35020V1

18.3 Bootloader version

The following table lists the STM32F427xx/437xx devices bootloader version.

Table 39. STM32F427xx/437xx bootloader version

Bootloader version number	Description	Known limitations
V3.0	Initial bootloader version.	<ul style="list-style-type: none"> – For the USART interface, two consecutive NACKs instead of 1 NACK are sent when a Read Memory or Write Memory command is sent and the RDP level is active. – For the CAN interface, the Write Unprotect command is not functional. Instead you can use Write Memory command and write directly to the option bytes in order to disable the write protection.

19 STM32F429xx/439xx devices bootloader

19.1 Bootloader V7.x

19.1.1 Bootloader configuration

The STM32F429xx/439xx bootloader is activated by applying pattern5 (described in [Table 2: Bootloader activation patterns](#)). The following table shows the hardware resources used by this bootloader.

Table 40. STM32F429xx/439xx configuration in System memory boot mode

Bootloader	Feature/Peripheral	State	Comment
Common to all bootloaders	RCC	HSI enabled	The system clock is equal to 24 MHz using the PLL. The HSI clock source is used at startup (interface detection phase) and when USART or I2C interfaces are selected (once CAN or DFU bootloader is selected, the clock source will be derived from external crystal).
		HSE enabled	The system clock is equal to 60 MHz. The HSE clock source is used only when the CAN or the DFU (USB FS Device) interfaces are selected. The external clock must provide a frequency multiple of 1 MHz and ranging from 4 MHz to 26 MHz.
		-	The Clock Security System (CSS) interrupt is enabled for the CAN and DFU bootloaders. Any failure (or removal) of the external clock generates system reset.
	RAM	-	8 Kbytes starting from address 0x20000000 are used by the bootloader firmware
	System memory	-	30424 bytes starting from address 0x1FFF0000, contain the bootloader firmware
	IWDG	-	The independent watchdog (IWDG) prescaler is configured to its maximum value. It is periodically refreshed to prevent watchdog reset (in case the hardware IWDG option was previously enabled by the user).
	Power	-	Voltage range is set to [1.62 V, 2.1 V]. In this range internal Flash write operations are allowed only in byte format (Half-Word, Word and Double-Word operations are not allowed). The voltage range can be configured in run time using bootloader commands.

Table 40. STM32F429xx/439xx configuration in System memory boot mode (continued)

Bootloader	Feature/Peripheral	State	Comment
USART1 bootloader	USART1	Enabled	Once initialized the USART1 configuration is: 8 bits, even parity and 1 Stop bit
	USART1_RX pin	Input	PA10 pin: USART1 in reception mode
	USART1_TX pin	Output	PA9 pin: USART1 in transmission mode
USART3 bootloader (on PB10/PB11)	USART3	Enabled	Once initialized the USART3 configuration is: 8 bits, even parity and 1 Stop bit
	USART3_RX pin	Input	PB11 pin: USART3 in reception mode
	USART3_TX pin	Output	PB10pin: USART3 in transmission mode
USART3 bootloader (on PC10/PC11)	USART3	Enabled	Once initialized the USART3 configuration is: 8 bits, even parity and 1 Stop bit
	USART3_RX pin	Input	PC11 pin: USART3 in reception mode
	USART3_TX pin	Output	PC10pin: USART3 in transmission mode
USART1 and USART3 bootloaders	SysTick timer	Enabled	Used to automatically detect the serial baud rate from the host for USARTx bootloaders.
CAN2 bootloader	CAN2	Enabled	Once initialized the CAN2 configuration is: Baudrate 125 kbps, 11-bit identifier. <i>Note: CAN1 is clocked during CAN2 bootloader execution because STM32F429xx/439xx CAN1 manages the communication between CAN2 and SRAM.</i>
	CAN2_RX pin	Input	PB05 pin: CAN2 in reception mode
	CAN2_TX pin	Output	PB13pin: CAN2 in transmission mode
I2C1 bootloader	I2C1	Enabled	The I2C1 configuration is: I2C speed: up to 400 KHz, 7-bit address, slave mode, slave address: 0x70, analog filter ON.
	I2C1_SCL pin	Input/output	PB6 pin: clock line is used in open-drain mode.
	I2C1_SDA pin	Input/output	PB9 pin: data line is used in open-drain mode.

Table 40. STM32F429xx/439xx configuration in System memory boot mode (continued)

Bootloader	Feature/Peripheral	State	Comment
DFU bootloader	USB_OTG_FS	Enabled	USB OTG FS configured in Forced Device mode. USB_OTG_FS interrupt vector is enabled and used for USB DFU communications.
	USB_OTG_FS_DM pin	Input	PA11 pin: USB OTG FS DM line
	USB_OTG_FS_DP pin	Output	PA12pin: USB OTG FS DP line
	TIM11	Enabled	This timer is used to determine the value of the external clock frequency. Once the external clock frequency is determined, the RCC system is configured to operate at 60 MHz system clock (using PLL).

The system clock is derived from the embedded internal high-speed RC for USARTx and I2Cx bootloaders. This internal clock is also used for CAN and DFU (USB FS Device) but only for the selection phase. An external clock multiple of 1 MHz (between 4 and 26 MHz) is required for CAN and DFU bootloader execution after the selection phase.

19.1.2 Bootloader selection

The figures below shows the bootloader detection mechanism.

Figure 23. Dual Bank Boot Implementation for STM32F429xx/439xx Bootloader V7.x

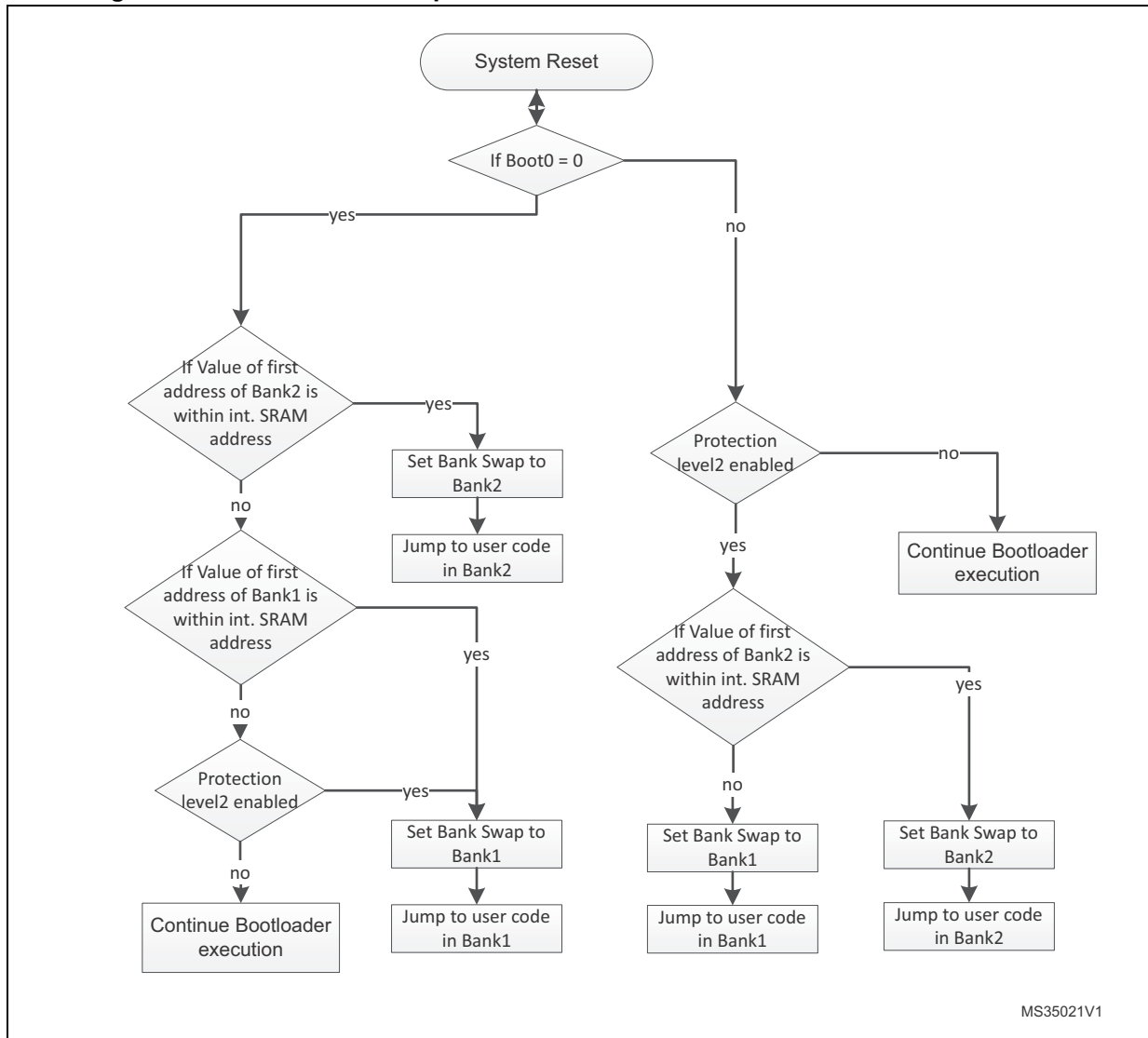
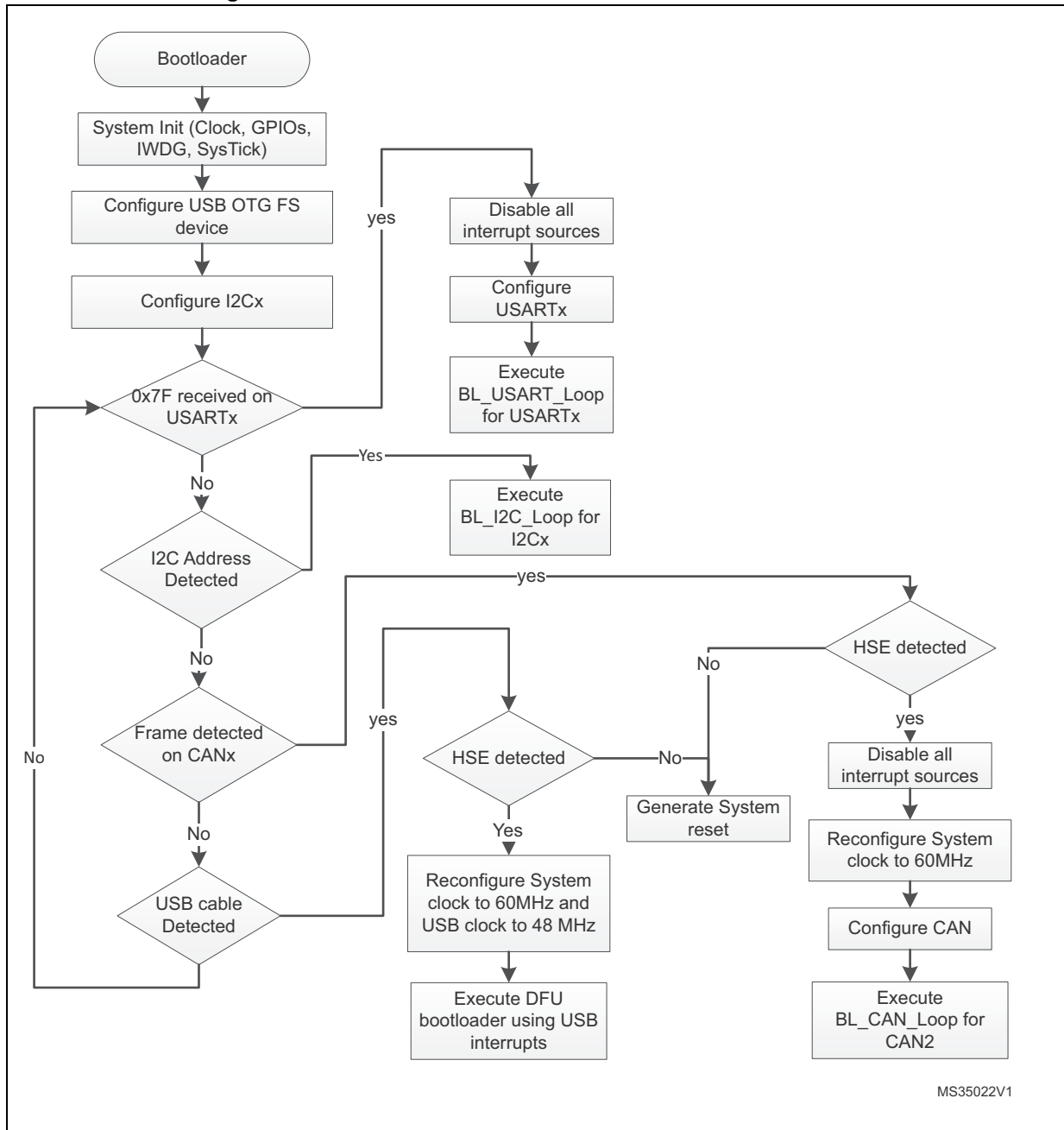

Figure 24. Bootloader V7.x selection for STM32F429xx/439xx



19.1.3 Bootloader version

The following table lists the STM32F429xx/439xx devices bootloader V7.x versions.

Table 41. STM32F429xx/439xx bootloader V7.x version

Bootloader version number	Description	Known limitations
V7.0	Initial bootloader version.	For the CAN interface, the Write Unprotect command is not functional. Instead you can use Write Memory command and write directly to the option bytes in order to disable the write protection.

19.2 Bootloader V9.x

19.2.1 Bootloader configuration

The STM32F429xx/439xx bootloader is activated by applying pattern5 (described in [Table 2: Bootloader activation patterns](#)). The following table shows the hardware resources used by this bootloader.

Table 42. STM32F429xx/439xx configuration in System memory boot mode

Bootloader	Feature/Peripheral	State	Comment
Common to all bootloaders	RCC	HSI enabled	The system clock is equal to 60 MHz using the PLL. The HSI clock source is used at startup (interface detection phase) and when USART or SPI or I2C interfaces are selected (once CAN or DFU bootloader is selected, the clock source will be derived from external crystal).
		HSE enabled	The system clock is equal to 60 MHz. The HSE clock source is used only when the CAN or the DFU (USB FS Device) interfaces are selected. The external clock must provide a frequency multiple of 1 MHz and ranging from 4 MHz to 26 MHz.
		-	The Clock Security System (CSS) interrupt is enabled for the CAN and DFU bootloaders. Any failure (or removal) of the external clock generates system reset.
	RAM	-	12 Kbytes starting from address 0x20000000 are used by the bootloader firmware
	System memory	-	30424 bytes starting from address 0x1FFF0000, contain the bootloader firmware
	IWDG	-	The independent watchdog (IWDG) prescaler is configured to its maximum value. It is periodically refreshed to prevent watchdog reset (in case the hardware IWDG option was previously enabled by the user).
	Power	-	Voltage range is set to [1.62 V, 2.1 V]. In this range internal Flash write operations are allowed only in byte format (Half-Word, Word and Double-Word operations are not allowed). The voltage range can be configured in run time using bootloader commands.
USART1 bootloader	USART1	Enabled	Once initialized the USART1 configuration is: 8-bits, even parity and 1 Stop bit
	USART1_RX pin	Input	PA10 pin: USART1 in reception mode
	USART1_TX pin	Output	PA9 pin: USART1 in transmission mode
USART3 bootloader (on PB10/PB11)	USART3	Enabled	Once initialized the USART3 configuration is: 8-bits, even parity and 1 Stop bit
	USART3_RX pin	Input	PB11 pin: USART3 in reception mode
	USART3_TX pin	Output	PB10 pin: USART3 in transmission mode

Table 42. STM32F429xx/439xx configuration in System memory boot mode (continued)

Bootloader	Feature/Peripheral	State	Comment
USART3 bootloader (on PC10/PC11)	USART3	Enabled	Once initialized the USART3 configuration is: 8-bits, even parity and 1 Stop bit
	USART3_RX pin	Input	PC11 pin: USART3 in reception mode
	USART3_TX pin	Output	PC10 pin: USART3 in transmission mode
USART1 and USART3 bootloaders	SysTick timer	Enabled	Used to automatically detect the serial baud rate from the host for USARTx bootloaders.
CAN2 bootloader	CAN2	Enabled	Once initialized the CAN2 configuration is: Baudrate 125 kbps, 11-bit identifier. Note: CAN1 is clocked during CAN2 bootloader execution because STM32F40xxx/41xxxCAN1 manages the communication between CAN2 and SRAM.
	CAN2_RX pin	Input	PB05 pin: CAN2 in reception mode
	CAN2_TX pin	Output	PB13 pin: CAN2 in transmission mode
I2C1 bootloader	I2C1	Enabled	The I2C1 configuration is: I2C speed: up to 400 KHz, 7-bit address, slave mode, slave address: 0x70, analog filter ON.
	I2C1_SCL pin	Input/output	PB6 pin: clock line is used in open-drain mode.
	I2C1_SDA pin	Input/output	PB9 pin: data line is used in open-drain mode.
I2C2 bootloader	I2C2	Enabled	The I2C2 configuration is: I2C speed: up to 400 KHz, 7-bit address, slave mode, slave address: 0x70, analog filter ON.
	I2C2_SCL pin	Input/output	PF0 pin: clock line is used in open-drain mode.
	I2C2_SDA pin	Input/output	PF1 pin: data line is used in open-drain mode.
I2C3 bootloader	I2C3	Enabled	The I2C3 configuration is: I2C speed: up to 400 KHz, 7-bit address, slave mode, slave address: 0x70, analog filter ON.
	I2C3_SCL pin	Input/output	PA8 pin: clock line is used in open-drain mode.
	I2C3_SDA pin	Input/output	PC9 pin: data line is used in open-drain mode.

Table 42. STM32F429xx/439xx configuration in System memory boot mode (continued)

Bootloader	Feature/Peripheral	State	Comment
SPI1 bootloader	SPI1	Enabled	The SPI1 configuration is: Slave mode, Full Duplex, 8-bit MSB, Speed up to 8MHz, Polarity: CPOL Low, CPHA Low, NSS hardware.
	SPI1_MOSI pin	Input	PA7 pin: Slave data Input line, used in Push-pull pull-down mode
	SPI1_MISO pin	Output	PA6 pin: Slave data output line, used in Push-pull pull-down mode
	SPI1_SCK pin	Input	PA5 pin: Slave clock line, used in Push-pull pull-down mode
	SPI1_NSS pin	Input	PA4 pin: Slave Chip Select pin used in Push-pull pull-up mode.
SPI2 bootloader	SPI2	Enabled	The SPI2 configuration is: Slave mode, Full Duplex, 8-bit MSB, Speed up to 8MHz, Polarity: CPOL Low, CPHA Low, NSS hardware.
	SPI2_MOSI pin	Input	PB15 pin: Slave data Input line, used in Push-pull pull-down mode
	SPI2_MISO pin	Output	PB14 pin: Slave data output line, used in Push-pull pull-down mode
	SPI2_SCK pin	Input	PB13 pin: Slave clock line, used in Push-pull pull-down mode
	SPI2_NSS pin	Input	PB12 pin: Slave Chip Select pin used in Push-pull pull-up mode.
SPI4 bootloader	SPI4	Enabled	The SPI4 configuration is: Slave mode, Full Duplex, 8-bit MSB, Speed up to 8MHz, Polarity: CPOL Low, CPHA Low, NSS hardware.
	SPI4_MOSI pin	Input	PE14 pin: Slave data Input line, used in Push-pull pull-down mode
	SPI4_MISO pin	Output	PE13 pin: Slave data output line, used in Push-pull pull-down mode
	SP4_SCK pin	Input	PE12 pin: Slave clock line, used in Push-pull pull-down mode
	SPI4_NSS pin	Input	PE11 pin: Slave Chip Select pin used in Push-pull pull-up mode.

Table 42. STM32F429xx/439xx configuration in System memory boot mode (continued)

Bootloader	Feature/Peripheral	State	Comment
DFU bootloader	USB_OTG_FS	Enabled	USB OTG FS configured in Forced Device mode. USB_OTG_FS interrupt vector is enabled and used for USB DFU communications.
	USB_OTG_FS_DM pin	Input	PA11 pin: USB OTG FS DM line
	USB_OTG_FS_DP pin	Output	PA12pin: USB OTG FS DP line
	TIM11	Enabled	This timer is used to determine the value of the external clock frequency. Once the external clock frequency is determined, the RCC system is configured to operate at 60 MHz system clock (using PLL).

The system clock is derived from the embedded internal high-speed RC for USARTx, I2Cx and SPIx bootloaders. This internal clock is also used for CAN and DFU (USB FS Device) but only for the selection phase. An external clock multiple of 1 MHz (between 4 and 26 MHz) is required for CAN and DFU bootloader execution after the selection phase.

19.2.2 Bootloader selection

The figures below shows the bootloader selection mechanism.

Figure 25. Dual Bank Boot Implementation for STM32F429xx/439xx Bootloader V9.x

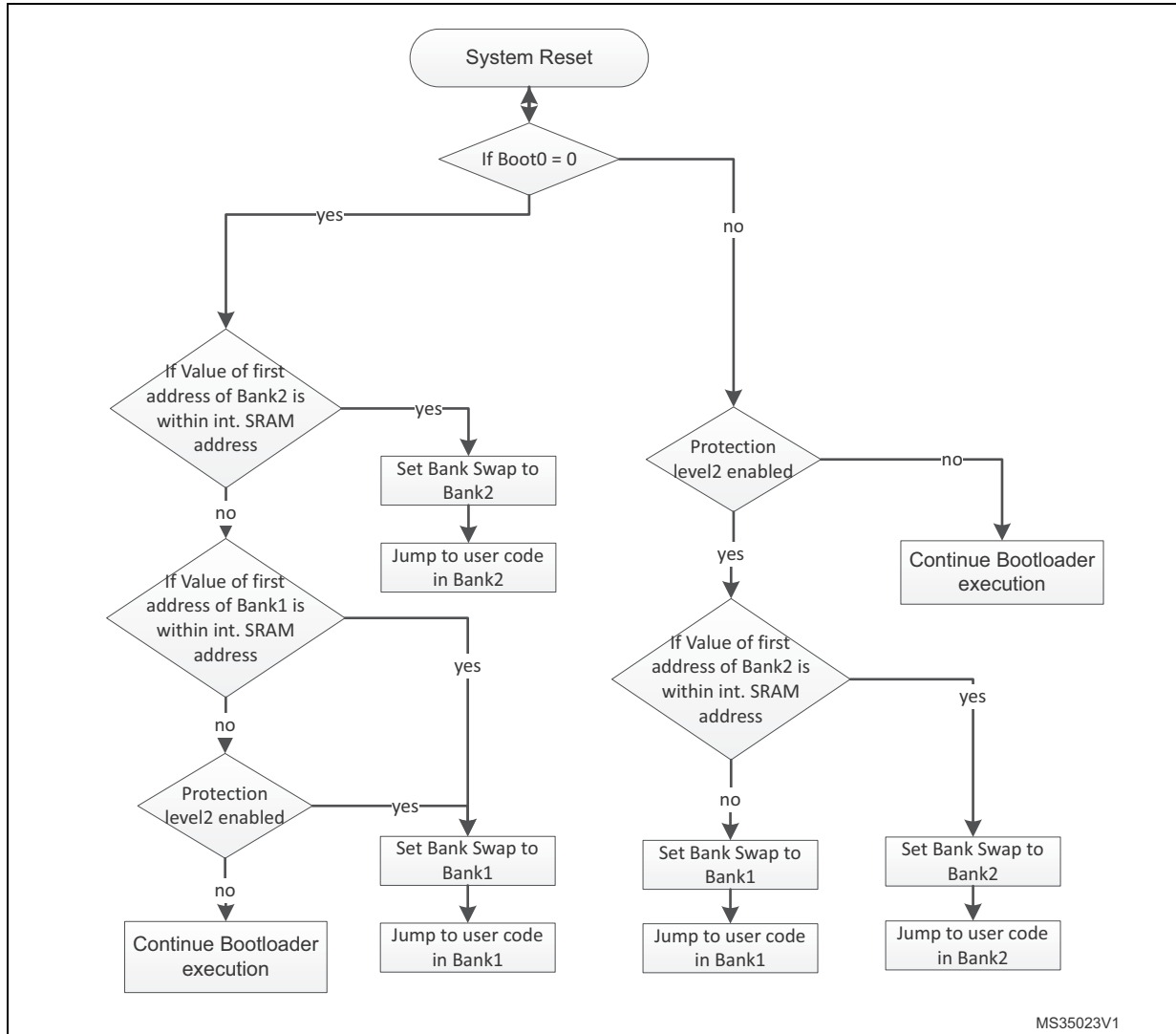
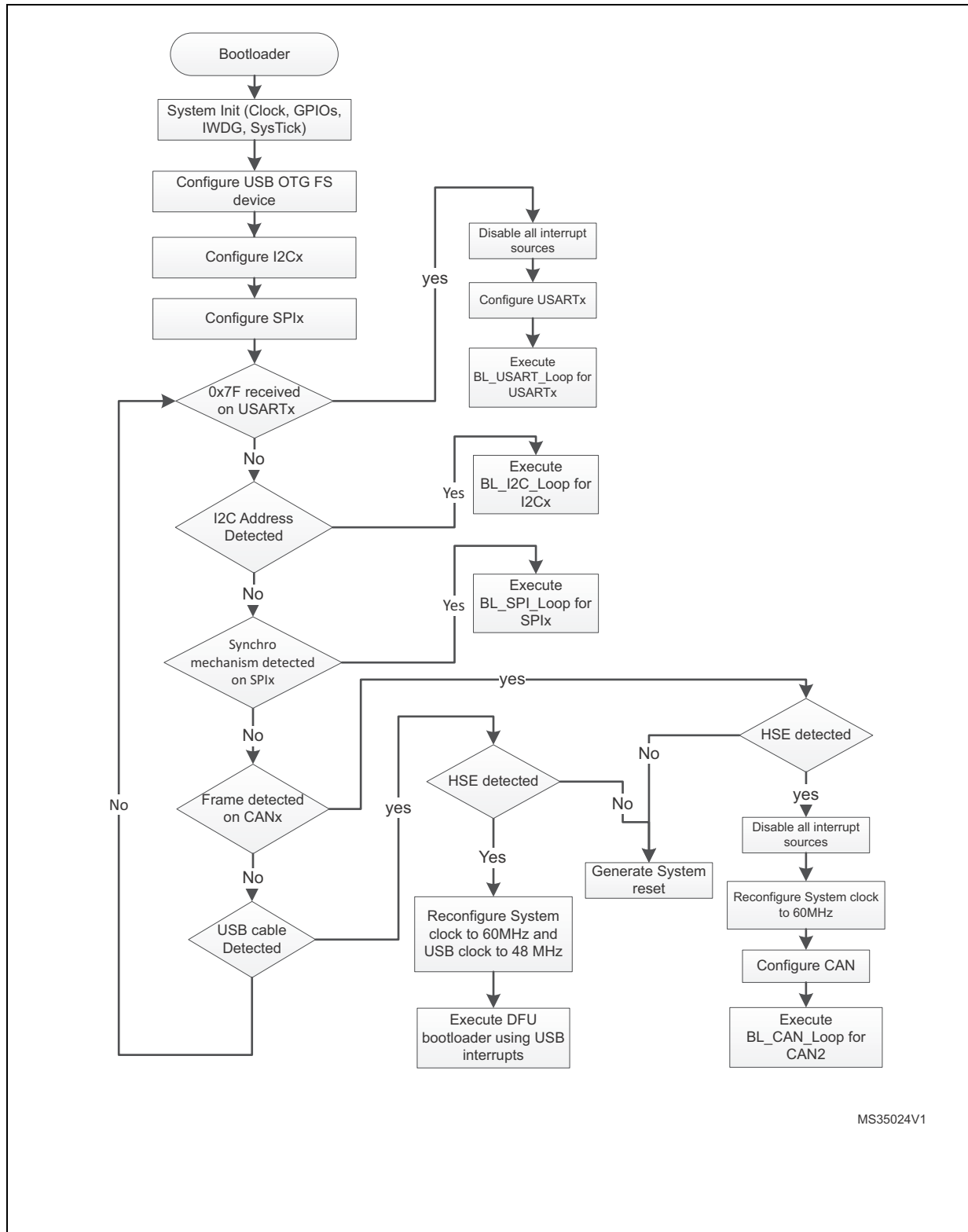

Figure 26. Bootloader V9.x selection for STM32F429xx/439xx



MS35024V1

19.2.3 Bootloader version

The following table lists the STM32F429xx/439xx bootloader V9.x versions.

Table 43. STM32F429xx/439xx bootloader V9.x version

Bootloader version number	Description	Known limitations
V9.0	This bootloader is an updated version of Bootloader v7.0. This new version of bootloader supports I2C2, I2C3, SPI1, SPI2 and SPI4 interfaces. The RAM used by this bootloader is increased from 8Kb to 12Kb. The ID of this bootloader is 0x90. The connection time is increased.	None
V9.1	This bootloader is an updated version of Bootloader v9.0. This new version implements the new I2C No-stretch commands (I2C protocol v1.1) and the capability of disabling PcROP when RDP1 is enabled with ReadOutUnprotect command for all protocols(USB, USART, CAN, I2C and SPI). The ID of this bootloader is 0x91	For the CAN interface, the Write Unprotect command is not functional. Instead you can use Write Memory command and write directly to the option bytes in order to disable the write protection.

20 STM32F042xx devices bootloader

20.1 Bootloader configuration

The STM32F042xx bootloader is activated by applying pattern6 (described in [Table 2: Bootloader activation patterns](#)). The following table shows the hardware resources used by this bootloader.

Table 44. STM32F042xx configuration in System memory boot mode

Bootloader	Feature/Peripheral	State	Comment
Common to all bootloaders	RCC	HSI (48MHz) enabled	The system clock is equal to 48 MHz with HSI 48 MHz as clock source.
		-	The Clock Recovery System (CRS) is enabled for the DFU bootloaders to allow USB to be clocked by HSI 48MHz.
	RAM	-	6 Kbytes starting from address 0x20000000 are used by the bootloader firmware
	System memory	-	13 Kbytes starting from address 0x1FFFC400, contain the bootloader firmware
	IWDG	-	The independent watchdog (IWDG) prescaler is configured to its maximum value. It is periodically refreshed to prevent watchdog reset (in case the hardware IWDG option was previously enabled by the user).
USART1 bootloader	USART1	Enabled	Once initialized the USART1 configuration is: 8-bits, even parity and 1 Stop bit
	USART1_RX pin	Input	PA10 pin: USART1 in reception mode
	USART1_TX pin	Output	PA9 pin: USART1 in transmission mode
USART2 bootloader	USART2	Enabled	Once initialized the USART2 configuration is: 8-bits, even parity and 1 Stop bit
	USART2_RX pin	Input	PA14 pin: USART2 in reception mode
	USART2_TX pin	Output	PA15 pin: USART2 in transmission mode
USART1 and USART2 bootloaders	SysTick timer	Enabled	Used to automatically detect the serial baud rate from the host for USARTx bootloaders.
I2C1 bootloader	I2C1	Enabled	The I2C1 configuration is: I2C speed: up to 400 KHz, 7-bit address, slave mode, slave address: 0x7C, analog filter enabled and digital filter disabled.
	I2C1_SCL pin	Input/output	PB6 pin: clock line is used in open-drain mode.
	I2C1_SDA pin	Input/output	PB7 pin: data line is used in open-drain mode.

Bootloader	Feature/Peripheral	State	Comment
DFU bootloader	USB	Enabled	USB FS configured in Forced Device mode. USB FS interrupt vector is enabled and used for USB DFU communications.
	USB_DM pin	Input	PA11 pin: USB FS DM line
	USB_DP pin	Output	PA12 pin: USB FS DP line

Note: After the STM32F042xx devices have booted in Bootloader mode using USART2, the serial wire debug (SWD) communication is no more possible until the system is reset, because SWD uses PA14 pin (SWCLK) which is already used by the Bootloader (USART2_RX).
 The system clock is derived from the embedded internal high-speed RC, no external quartz is required for the bootloader execution.

20.2 Bootloader selection

The figure below shows the bootloader detection mechanism.

Figure 27. Bootloader selection for STM32F042xx

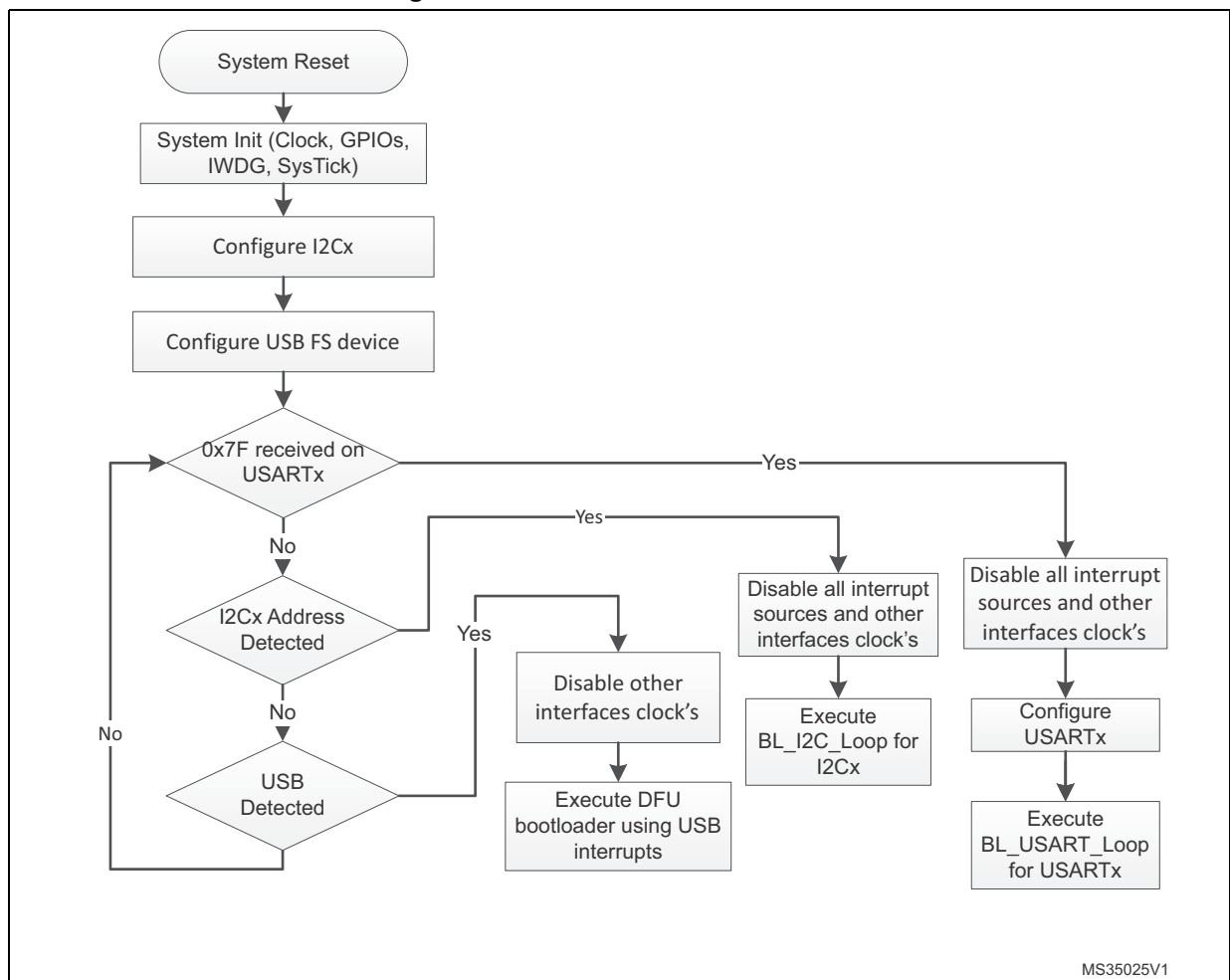

20.3 Bootloader version

The following table lists the STM32F042xx bootloader versions:

Table 45. STM32F042xx bootloader versions

Bootloader version number	Description	Known limitations
V10.0	Initial bootloader version	none

21 STM32F072xx devices bootloader

21.1 Bootloader configuration

The STM32F072xx bootloader is activated by applying pattern6 (described in [Table 2: Bootloader activation patterns](#)). The following table shows the hardware resources used by this bootloader.

Table 46. STM32F072xx configuration in System memory boot mode

Bootloader	Feature/Peripheral	State	Comment
Common to all bootloaders	RCC	HSI (48MHz) enabled	The system clock is equal to 48 MHz with HSI 48 MHz as clock source.
		-	The Clock Recovery System (CRS) is enabled for the DFU bootloaders to allow USB to be clocked by HSI 48MHz.
	RAM	-	6 Kbytes starting from address 0x20000000 are used by the bootloader firmware
	System memory	-	12 Kbytes starting from address 0x1FFFC800, contain the bootloader firmware
	IWDG	-	The independent watchdog (IWDG) prescaler is configured to its maximum value. It is periodically refreshed to prevent watchdog reset (in case the hardware IWDG option was previously enabled by the user).
USART1 bootloader	USART1	Enabled	Once initialized the USART1 configuration is: 8-bits, even parity and 1 Stop bit
	USART1_RX pin	Input	PA10 pin: USART1 in reception mode
	USART1_TX pin	Output	PA9 pin: USART1 in transmission mode
USART2 bootloader	USART2	Enabled	Once initialized the USART2 configuration is: 8-bits, even parity and 1 Stop bit
	USART2_RX pin	Input	PA14 pin: USART2 in reception mode
	USART2_TX pin	Output	PA15 pin: USART2 in transmission mode
USART1 and USART2 bootloaders	SysTick timer	Enabled	Used to automatically detect the serial baud rate from the host for USARTx bootloaders.
I2C1 bootloader	I2C1	Enabled	The I2C1 configuration is: I2C speed: up to 400 KHz, 7-bit address, slave mode, slave address: 0x76, analog filter enabled and digital filter disabled.
	I2C1_SCL pin	Input/output	PB6 pin: clock line is used in open-drain mode.
	I2C1_SDA pin	Input/output	PB7 pin: data line is used in open-drain mode.

Bootloader	Feature/Peripheral	State	Comment
DFU bootloader	USB	Enabled	USB FS configured in Forced Device mode. USB FS interrupt vector is enabled and used for USB DFU communications.
	USB_DM pin	Input	PA11 pin: USB FS DM line
	USB_DP pin	Output	PA12 pin: USB FS DP line

Note: After the STM32F072xx devices have booted in Bootloader mode using USART2, the serial wire debug (SWD) communication is no more possible until the system is reset, because SWD uses PA14 pin (SWCLK) which is already used by the Bootloader (USART2_RX).
 The system clock is derived from the embedded internal high-speed RC, no external quartz is required for the bootloader execution.

21.2 Bootloader selection

The figure below shows the bootloader detection mechanism.

Figure 28. Bootloader selection for STM32F072xx

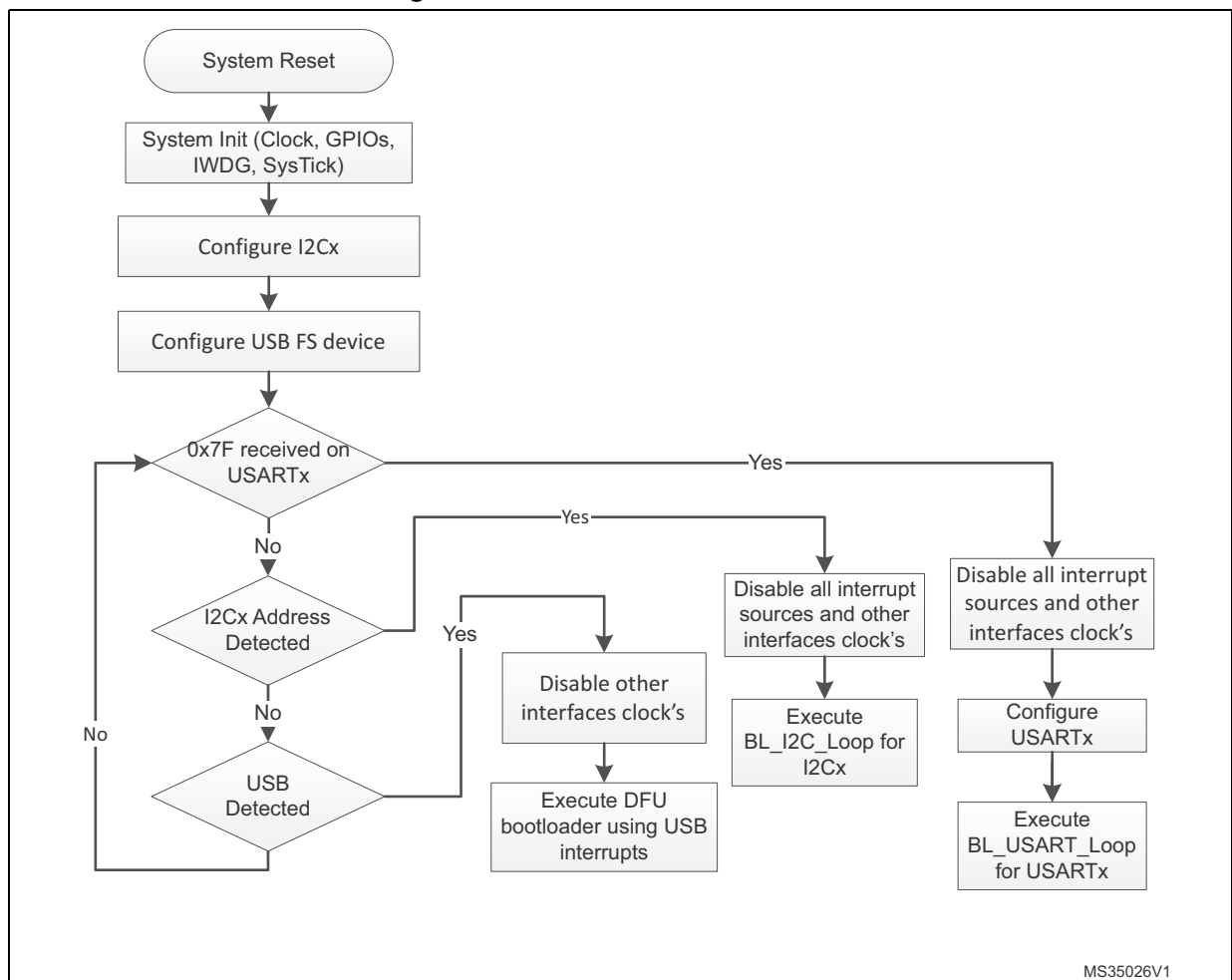

MS35026V1

21.3 Bootloader version

The following table lists the STM32F072xx bootloader versions:

Table 47. STM32F072xx bootloader versions

Bootloader version number	Description	Known limitations
V10.1	Initial bootloader version	none

22 STM32F301xx/302x4(6/8) devices bootloader

22.1 Bootloader configuration

The STM32F301xx/302x4(6/8) bootloader is activated by applying pattern2 (described in [Table 2: Bootloader activation patterns](#)). The following table shows the hardware resources used by this bootloader.

Table 48. STM32F301xx/302x4(6/8) configuration in System memory boot mode

Bootloader	Feature/Peripheral	State	Comment
Common to all bootloaders	RCC	HSI enabled	The system clock is equal to 48 MHz with HSI 48 MHz as clock source.
		HSE enabled	The external clock can be used for all bootloader interfaces and should have one the following values 24, 18,16, 12, 9, 8, 6, 4, 3 MHz. The PLL is used to generate the USB 48 MHz clock and the 48 MHz clock for the system clock.
		CSS	The clock security system (CSS) interrupt is enabled for the DFU bootloader. Any failure (or removal) of the external clock generates system reset.
	RAM	-	6 Kbytes starting from address 0x20000000 are used by the bootloader firmware
	System memory	-	8 Kbytes starting from address 0x1FFFD800, contain the bootloader firmware
	IWDG	-	The independent watchdog (IWDG) prescaler is configured to its maximum value. It is periodically refreshed to prevent watchdog reset (in case the hardware IWDG option was previously enabled by the user).
USART1 bootloader	USART1	Enabled	Once initialized the USART1 configuration is: 8-bits, even parity and 1 Stop bit
	USART1_RX pin	Input	PA10 pin: USART1 in reception mode
	USART1_TX pin	Output	PA9 pin: USART1 in transmission mode
USART2 bootloader	USART2	Enabled	Once initialized the USART2 configuration is: 8-bits, even parity and 1 Stop bit
	USART2_RX pin	Input	PA2 pin: USART2 in reception mode
	USART2_TX pin	Output	PA3 pin: USART2 in transmission mode
USART1 and USART2 bootloaders	SysTick timer	Enabled	Used to automatically detect the serial baud rate from the host for USARTx bootloaders.

Bootloader	Feature/Peripheral	State	Comment
DFU bootloader	USB	Enabled	USB FS configured in Forced Device mode. USB FS interrupt vector is enabled and used for USB DFU communications.
	USB_DM pin	Input	PA11 pin: USB FS DM line
	USB_DP pin	Output	PA12 pin: USB FS DP line An external pull-up resistor 1.5 Kohm must be connected to USB_DP pin.

The bootloader has two case of operation depending on the presence of the external clock (HSE) at bootloader startup:

- If HSE is present and has a value of 24, 18, 16, 12, 9, 8, 6, 4 or 3 MHz, the system clock is configured to 48 Mhz with HSE as clock source. The DFU interface, USART1 and USART2 are functional and can be used to communicate with the bootloader device.
- If HSE is not present, the HSI is kept as default clock source and only USART1 and USART2 are functional.

The external clock (HSE) must be kept if it's connected at bootloader startup because it will be used as system clock source.

22.2 Bootloader selection

The figure below shows the bootloader detection mechanism.

Figure 29. Bootloader selection for STM32F301xx/302x4(6/8)

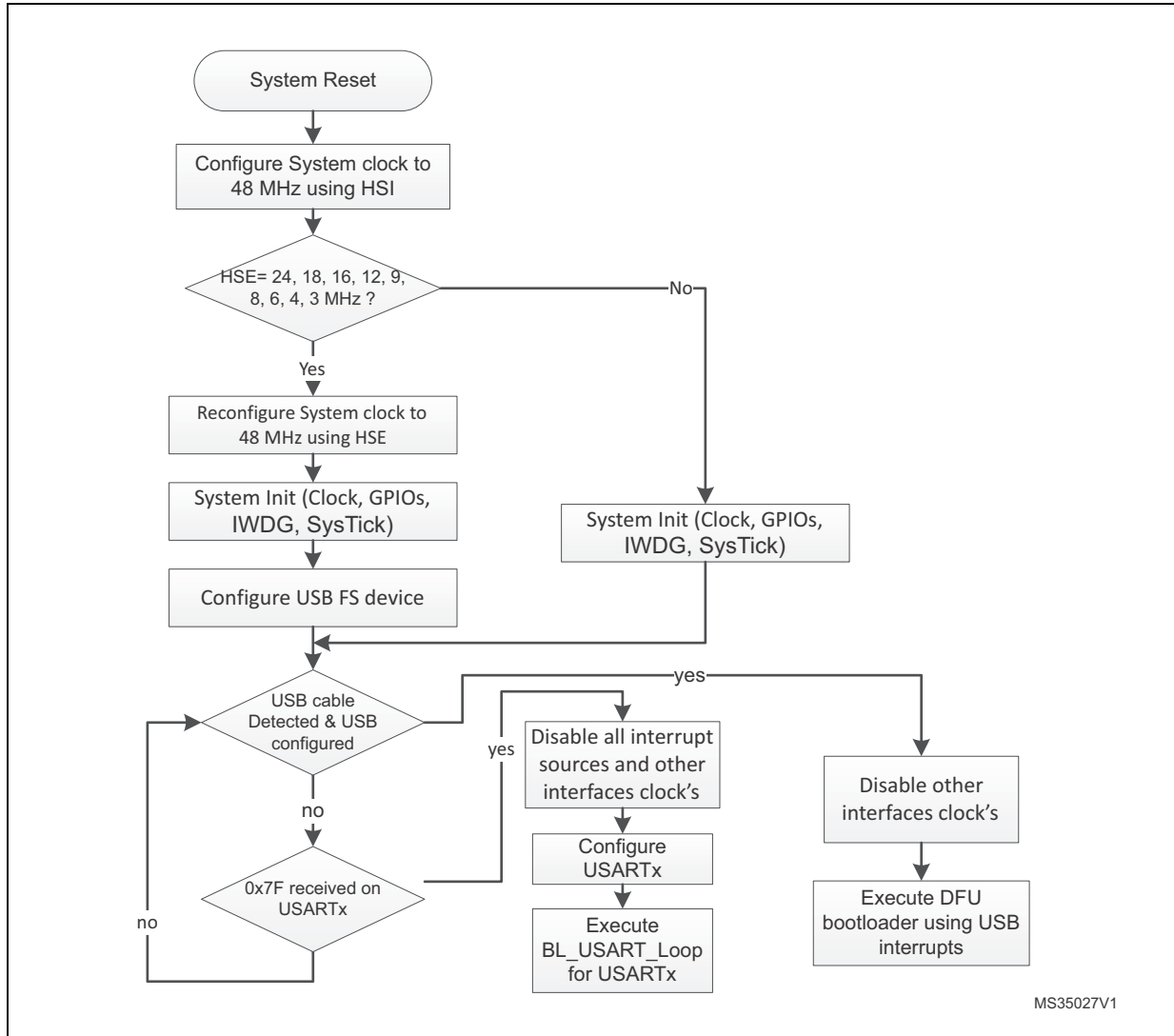

22.3 Bootloader version

The following table lists the STM32F301xx/302x4(6/8) bootloader versions:

Table 49. STM32F301xx/302x4(6/8) bootloader versions

Bootloader version number	Description	Known limitations
V4.0	Initial bootloader version	none

23 STM32F318xx devices bootloader

23.1 Bootloader configuration

The STM32F318xx bootloader is activated by applying pattern2 (described in [Table 2: Bootloader activation patterns](#)). The following table shows the hardware resources used by this bootloader.

Table 50. STM32F318xx configuration in System memory boot mode

Bootloader	Feature/Peripheral	State	Comment
Common to all bootloaders	RCC	HSI enabled	The system clock is equal to 60 MHz with HSI 8 MHz as clock source.
	RAM	-	6 Kbytes starting from address 0x20000000 are used by the bootloader firmware
	System memory	-	8 Kbytes starting from address 0x1FFFD800, contain the bootloader firmware
	IWDG	-	The independent watchdog (IWDG) prescaler is configured to its maximum value. It is periodically refreshed to prevent watchdog reset (in case the hardware IWDG option was previously enabled by the user).
USART1 bootloader	USART1	Enabled	Once initialized the USART1 configuration is: 8-bits, even parity and 1 Stop bit
	USART1_RX pin	Input	PA10 pin: USART1 in reception mode
	USART1_TX pin	Output	PA9 pin: USART1 in transmission mode
USART2 bootloader	USART2	Enabled	Once initialized the USART2 configuration is: 8-bits, even parity and 1 Stop bit
	USART2_RX pin	Input	PA2 pin: USART2 in reception mode
	USART2_TX pin	Output	PA3 pin: USART2 in transmission mode
USART1 and USART2 bootloaders	SysTick timer	Enabled	Used to automatically detect the serial baud rate from the host for USARTx bootloaders.
I2C1 bootloader	I2C1	Enabled	The I2C1 configuration is: I2C speed: up to 400 KHz, 7-bit address, slave mode, slave address: 0x7A, analog filter ON and digital filter disabled.
	I2C1_SCL pin	Input/output	PB6 pin: clock line is used in open-drain mode.
	I2C1_SDA pin	Input/output	PB7 pin: data line is used in open-drain mode.

Bootloader	Feature/Peripheral	State	Comment
I2C3bootloader	I2C3	Enabled	The I2C3 configuration is: I2C speed: up to 400 KHz, 7-bit address, slave mode, slave address: 0x7A, analog filter ON and digital filter disabled.
	I2C3_SCL pin	Input/output	PA8 pin: clock line is used in open-drain mode.
	I2C3_SDA pin	Input/output	PB5 pin: data line is used in open-drain mode.

The system clock is derived from the embedded internal high-speed RC, no external quartz is required for the bootloader execution.

23.2 Bootloader selection

The figure below shows the bootloader detection mechanism.

Figure 30. Bootloader selection for STM32F318xx

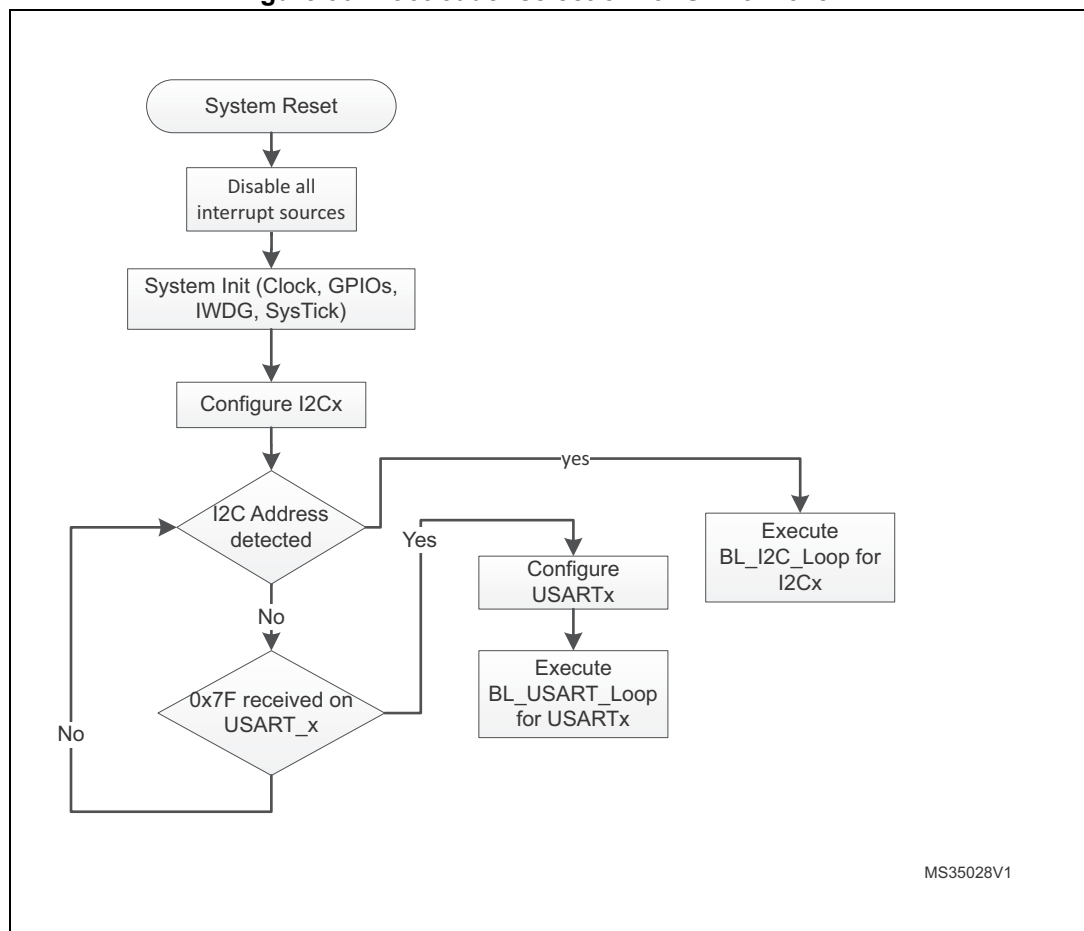

MS35028V1

23.3 Bootloader version

The following table lists the STM32F318xx bootloader versions:

Table 51. STM32F318xx bootloader versions

Bootloader version number	Description	Known limitations
V5.0	Initial bootloader version	none

24 STM32F303x4(6/8)/334xx/328xx devices bootloader

24.1 Bootloader configuration

The STM32F303x4(6/8)/334xx/328xx bootloader is activated by applying pattern2 (described in [Table 2: Bootloader activation patterns](#)). The following table shows the hardware resources used by this bootloader.

Table 52. STM32F303x4(6/8)/334xx/328xx configuration in System memory boot mode

Bootloader	Feature/Peripheral	State	Comment
Common to all bootloaders	RCC	HSI enabled	The system clock is equal to 60 MHz with HSI 8 MHz as clock source.
	RAM	-	6 Kbytes starting from address 0x20000000 are used by the bootloader firmware
	System memory	-	8 Kbytes starting from address 0x1FFFD800, contain the bootloader firmware
	IWDG	-	The independent watchdog (IWDG) prescaler is configured to its maximum value. It is periodically refreshed to prevent watchdog reset (in case the hardware IWDG option was previously enabled by the user).
USART1 bootloader	USART1	Enabled	Once initialized the USART1 configuration is: 8-bits, even parity and 1 Stop bit
	USART1_RX pin	Input	PA10 pin: USART1 in reception mode
	USART1_TX pin	Output	PA9 pin: USART1 in transmission mode
USART2 bootloader	USART2	Enabled	Once initialized the USART2 configuration is: 8-bits, even parity and 1 Stop bit
	USART2_RX pin	Input	PA2 pin: USART2 in reception mode
	USART2_TX pin	Output	PA3 pin: USART2 in transmission mode
USART1 and USART2 bootloaders	SysTick timer	Enabled	Used to automatically detect the serial baud rate from the host for USARTx bootloaders.
I2C1 bootloader	I2C1	Enabled	The I2C1 configuration is: I2C speed: up to 400 KHz, 7-bit address, slave mode, slave address: 0x7E, analog filter ON and digital filter disabled.
	I2C1_SCL pin	Input/output	PB6 pin: clock line is used in open-drain mode.
	I2C1_SDA pin	Input/output	PB7 pin: data line is used in open-drain mode.

The system clock is derived from the embedded internal high-speed RC, no external quartz is required for the bootloader execution.

24.2 Bootloader selection

The figure below shows the bootloader detection mechanism.

Figure 31. Bootloader selection for STM32F303x4(6/8)/334xx/328xx

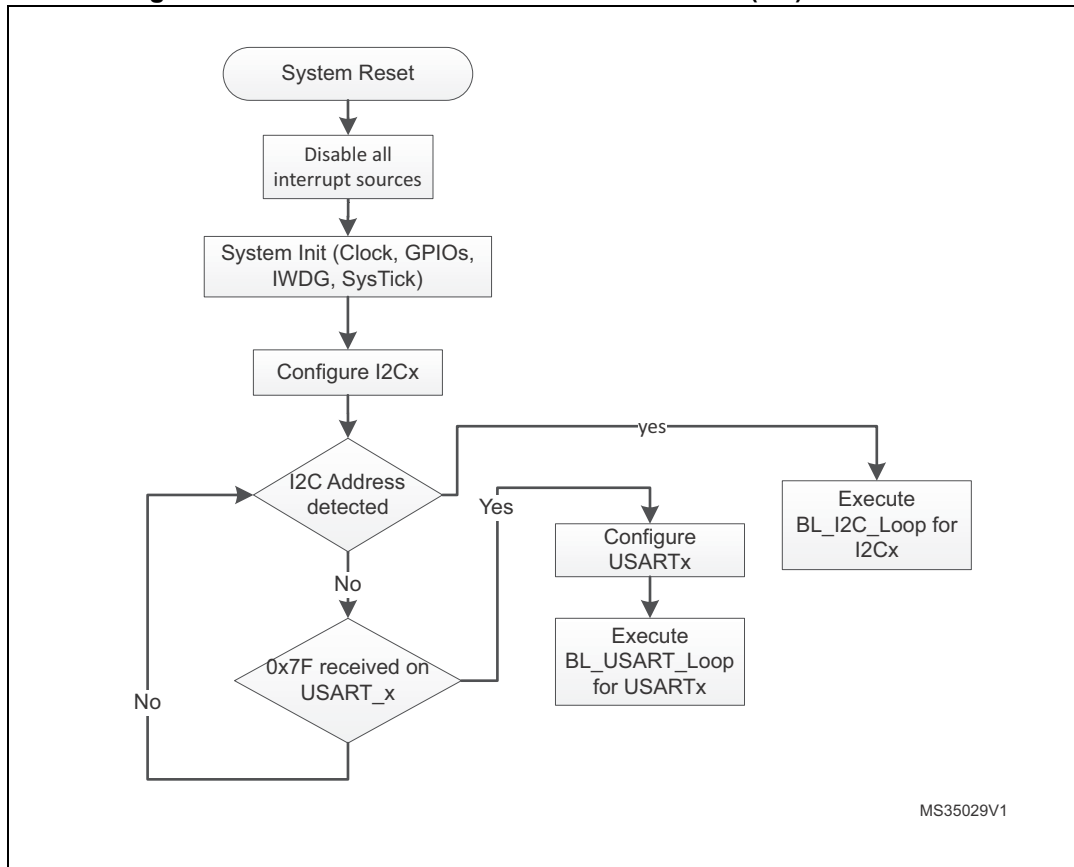

24.3 Bootloader version

The following table lists the STM32F303x4(6/8)/334xx/328xx bootloader versions:

Table 53. STM32F303x4(6/8)/334xx/328xx bootloader versions

Bootloader version number	Description	Known limitations
V5.0	Initial bootloader version	none

25 STM32F401xB(C) devices bootloader

25.1 Bootloader configuration

The STM32F401xB(C) bootloader is activated by applying pattern1 (described in [Table 2: Bootloader activation patterns](#)). The following table shows the hardware resources used by this bootloader.

Table 54. STM32F401xB(C) configuration in System memory boot mode

Bootloader	Feature/Peripheral	State	Comment
Common to all bootloaders	RCC	HSI enabled	The system clock is equal to 60 MHz using the PLL. The HSI clock source is used at startup (interface detection phase) and when USART or SPI or I2C interfaces are selected (once DFU bootloader is selected, the clock source will be derived from external crystal).
		HSE enabled	The system clock is equal to 60 MHz. The HSE clock source is used only when the DFU (USB FS Device) interfaces are selected. The external clock must provide a frequency multiple of 1 MHz and ranging from 4 MHz to 26 MHz.
		-	The Clock Security System (CSS) interrupt is enabled for the CAN and DFU bootloaders. Any failure (or removal) of the external clock generates system reset.
	RAM	-	12 Kbytes starting from address 0x20000000 are used by the bootloader firmware
	System memory	-	30424 bytes starting from address 0x1FFF0000, contain the bootloader firmware
	IWDG	-	The independent watchdog (IWDG) prescaler is configured to its maximum value. It is periodically refreshed to prevent watchdog reset (in case the hardware IWDG option was previously enabled by the user).
	Power	-	Voltage range is set to [1.62 V, 2.1 V]. In this range internal Flash write operations are allowed only in byte format (Half-Word, Word and Double-Word operations are not allowed). The voltage range can be configured in run time using bootloader commands.

Table 54. STM32F401xB(C) configuration in System memory boot mode (continued)

Bootloader	Feature/Peripheral	State	Comment
USART1 bootloader	USART1	Enabled	Once initialized the USART1 configuration is: 8-bits, even parity and 1 Stop bit
	USART1_RX pin	Input	PA10 pin: USART1 in reception mode
	USART1_TX pin	Output	PA9 pin: USART1 in transmission mode
USART2 bootloader	USART2	Enabled	Once initialized the USART2 configuration is: 8-bits, even parity and 1 Stop bit
	USART2_RX pin	Input	PD06 pin: USART2 in reception mode
	USART2_TX pin	Output	PD05pin: USART2 in transmission mode
USART1 and USART2 bootloaders	SysTick timer	Enabled	Used to automatically detect the serial baud rate from the host for USARTx bootloaders.
I2C1 bootloader	I2C1	Enabled	The I2C1 configuration is: I2C speed: 400 KHz, 7-bit address, slave mode, slave address: 0x72, analog filter ON.
	I2C1_SCL pin	Input/output	PB6 pin: clock line is used in open-drain mode.
	I2C1_SDA pin	Input/output	PB7 pin: data line is used in open-drain mode.
I2C2 bootloader	I2C2	Enabled	The I2C2 configuration is: I2C speed: 400 KHz, 7-bit address, slave mode, slave address: 0x72, analog filter ON.
	I2C2_SCL pin	Input/output	PB10 pin: clock line is used in open-drain mode.
	I2C2_SDA pin	Input/output	PB3 pin: data line is used in open-drain mode.
I2C3 bootloader	I2C3	Enabled	The I2C3 configuration is: I2C speed: 400 KHz, 7-bit address, slave mode, slave address: 0x72, analog filter ON.
	I2C3_SCL pin	Input/output	PA8 pin: clock line is used in open-drain mode.
	I2C3_SDA pin	Input/output	PB4 pin: data line is used in open-drain mode.

Table 54. STM32F401xB(C) configuration in System memory boot mode (continued)

Bootloader	Feature/Peripheral	State	Comment
SPI1 bootloader	SPI1	Enabled	The SPI1 configuration is: Slave mode, Full Duplex, 8-bit MSB, Speed up to 8MHz, Polarity: CPOL Low, CPHA Low, NSS hardware.
	SPI1_MOSI pin	Input	PA7 pin: Slave data Input line, used in Push-pull pull-down mode
	SPI1_MISO pin	Output	PA6 pin: Slave data output line, used in Push-pull pull-down mode
	SPI1_SCK pin	Input	PA5 pin: Slave clock line, used in Push-pull pull-down mode
	SPI1_NSS pin	Input	PA4 pin: Slave Chip Select pin used in Push-pull pull-up mode.
SPI2 bootloader	SPI2	Enabled	The SPI2 configuration is: Slave mode, Full Duplex, 8-bit MSB, Speed up to 8MHz, Polarity: CPOL Low, CPHA Low, NSS hardware.
	SPI2_MOSI pin	Input	PB15 pin: Slave data Input line, used in Push-pull pull-down mode
	SPI2_MISO pin	Output	PB14 pin: Slave data output line, used in Push-pull pull-down mode
	SPI2_SCK pin	Input	PB13 pin: Slave clock line, used in Push-pull pull-down mode
	SPI2_NSS pin	Input	PB12 pin: Slave Chip Select pin used in Push-pull pull-up mode.
SPI3 bootloader	SPI3	Enabled	The SPI3 configuration is: Slave mode, Full Duplex, 8-bit MSB, Speed up to 8MHz, Polarity: CPOL Low, CPHA Low, NSS hardware.
	SPI3_MOSI pin	Input	PC12 pin: Slave data Input line, used in Push-pull pull-down mode
	SPI3_MISO pin	Output	PC11 pin: Slave data output line, used in Push-pull pull-down mode
	SPI3_SCK pin	Input	PC10 pin: Slave clock line, used in Push-pull pull-down mode
	SPI3_NSS pin	Input	PA15 pin: Slave Chip Select pin used in Push-pull pull-up mode.

Table 54. STM32F401xB(C) configuration in System memory boot mode (continued)

Bootloader	Feature/Peripheral	State	Comment
DFU bootloader	USB_OTG_FS	Enabled	USB OTG FS configured in Forced Device mode. USB_OTG_FS interrupt vector is enabled and used for USB DFU communications.
	USB_OTG_FS_DM pin	Input	PA11 pin: USB OTG FS DM line
	USB_OTG_FS_DP pin	Output	PA12pin: USB OTG FS DP line
	TIM11	Enabled	This timer is used to determine the value of the external clock frequency. Once the external clock frequency is determined, the RCC system is configured to operate at 60 MHz system clock (using PLL).

The system clock is derived from the embedded internal high-speed RC for USARTx, I2Cx and SPIx bootloaders. This internal clock is also used for CAN and DFU (USB FS Device) but only for the selection phase. An external clock multiple of 1 MHz (between 4 and 26 MHz) is required for CAN and DFU bootloader execution after the selection phase.

25.2 Bootloader selection

The figures below shows the bootloader selection mechanism.

Figure 32. Bootloader selection for STM32F401xB(C)

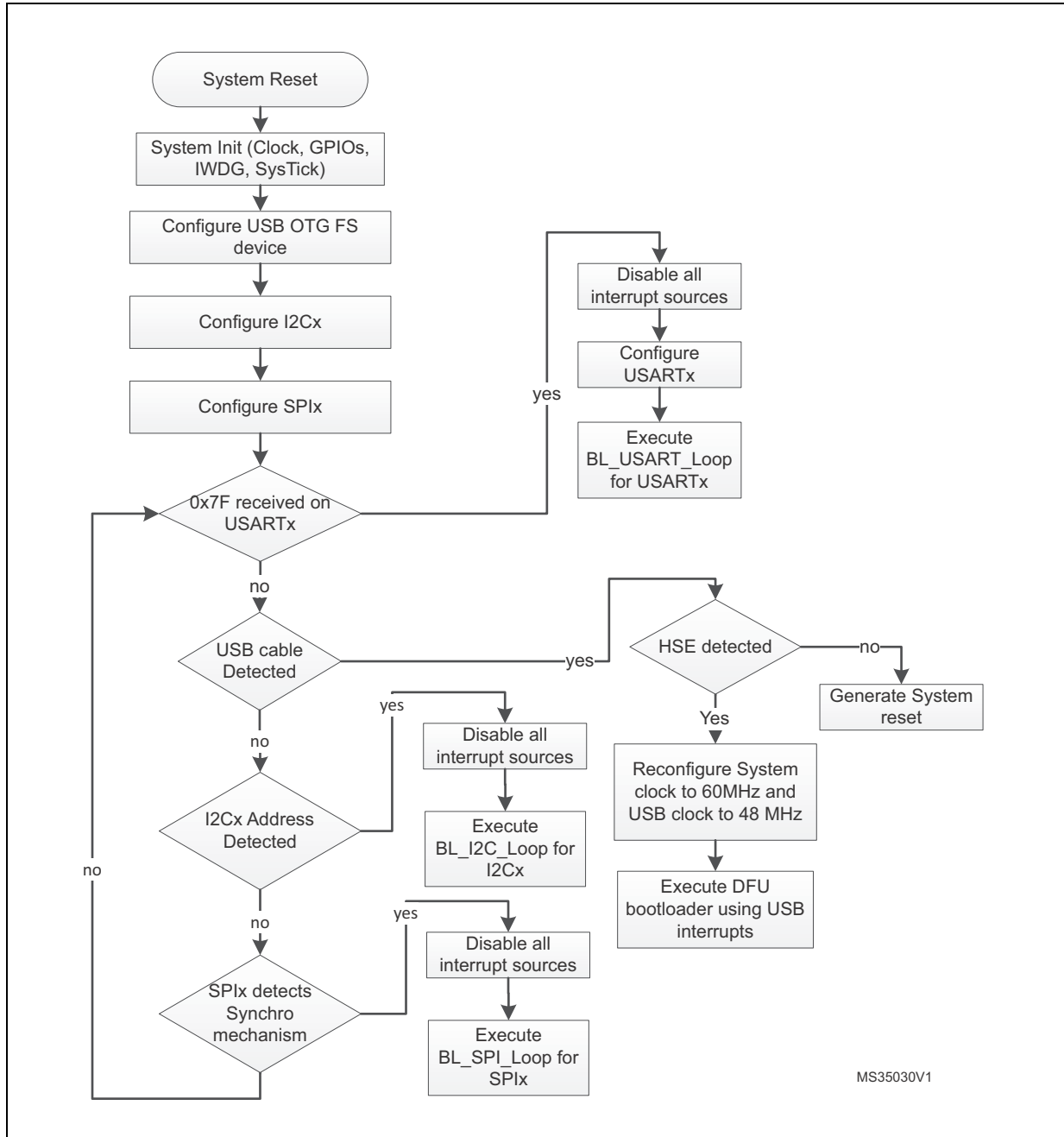

MS35030V1

25.3 Bootloader version

The following table lists the STM32F401xB(C) bootloader version.

Table 55. STM32F401xB(C) bootloader version

Bootloader version number	Description	Known limitations
V13.0	Initial bootloader version.	None

26 STM32F401xD(E) devices bootloader

26.1 Bootloader configuration

The STM32F401xD(E) bootloader is activated by applying pattern1 (described in [Table 2: Bootloader activation patterns](#)). The following table shows the hardware resources used by this bootloader.

Table 56. STM32F401xD(E) configuration in System memory boot mode

Bootloader	Feature/Peripheral	State	Comment
Common to all bootloaders	RCC	HSI enabled	The system clock is equal to 60 MHz using the PLL. The HSI clock source is used at startup (interface detection phase) and when USART or SPI or I2C interfaces are selected (once DFU bootloader is selected, the clock source will be derived from external crystal).
		HSE enabled	The system clock is equal to 60 MHz. The HSE clock source is used only when the DFU (USB FS Device) interfaces are selected. The external clock must provide a frequency multiple of 1 MHz and ranging from 4 MHz to 26 MHz.
		-	The Clock Security System (CSS) interrupt is enabled for the CAN and DFU bootloaders. Any failure (or removal) of the external clock generates system reset.
	RAM	-	12 Kbytes starting from address 0x20000000 are used by the bootloader firmware
	System memory	-	30424 bytes starting from address 0x1FFF0000, contain the bootloader firmware
	IWDG	-	The independent watchdog (IWDG) prescaler is configured to its maximum value. It is periodically refreshed to prevent watchdog reset (in case the hardware IWDG option was previously enabled by the user).
	Power	-	Voltage range is set to [1.62 V, 2.1 V]. In this range internal Flash write operations are allowed only in byte format (Half-Word, Word and Double-Word operations are not allowed). The voltage range can be configured in run time using bootloader commands.

Table 56. STM32F401xD(E) configuration in System memory boot mode (continued)

Bootloader	Feature/Peripheral	State	Comment
USART1 bootloader	USART1	Enabled	Once initialized the USART1 configuration is: 8-bits, even parity and 1 Stop bit
	USART1_RX pin	Input	PA10 pin: USART1 in reception mode
	USART1_TX pin	Output	PA9 pin: USART1 in transmission mode
USART2 bootloader	USART2	Enabled	Once initialized the USART2 configuration is: 8-bits, even parity and 1 Stop bit
	USART2_RX pin	Input	PD06 pin: USART2 in reception mode
	USART2_TX pin	Output	PD05pin: USART2 in transmission mode
USART1 and USART2 bootloaders	SysTick timer	Enabled	Used to automatically detect the serial baud rate from the host for USARTx bootloaders.
I2C1 bootloader	I2C1	Enabled	The I2C1 configuration is: I2C speed: 400 KHz, 7-bit address, slave mode, slave address: 0x72, analog filter ON.
	I2C1_SCL pin	Input/output	PB6 pin: clock line is used in open-drain mode.
	I2C1_SDA pin	Input/output	PB7 pin: data line is used in open-drain mode.
I2C2 bootloader	I2C2	Enabled	The I2C2 configuration is: I2C speed: 400 KHz, 7-bit address, slave mode, slave address: 0x72, analog filter ON.
	I2C2_SCL pin	Input/output	PB10 pin: clock line is used in open-drain mode.
	I2C2_SDA pin	Input/output	PB3 pin: data line is used in open-drain mode.
I2C3 bootloader	I2C3	Enabled	The I2C3 configuration is: I2C speed: 400 KHz, 7-bit address, slave mode, slave address: 0x72, analog filter ON.
	I2C3_SCL pin	Input/output	PA8 pin: clock line is used in open-drain mode.
	I2C3_SDA pin	Input/output	PB4 pin: data line is used in open-drain mode.

Table 56. STM32F401xD(E) configuration in System memory boot mode (continued)

Bootloader	Feature/Peripheral	State	Comment
SPI1 bootloader	SPI1	Enabled	The SPI1 configuration is: Slave mode, Full Duplex, 8-bit MSB, Speed up to 8MHz, Polarity: CPOL Low, CPHA Low, NSS hardware.
	SPI1_MOSI pin	Input	PA7 pin: Slave data Input line, used in Push-pull pull-down mode
	SPI1_MISO pin	Output	PA6 pin: Slave data output line, used in Push-pull pull-down mode
	SPI1_SCK pin	Input	PA5 pin: Slave clock line, used in Push-pull pull-down mode
	SPI1_NSS pin	Input	PA4 pin: Slave Chip Select pin used in Push-pull pull-up mode.
SPI2 bootloader	SPI2	Enabled	The SPI2 configuration is: Slave mode, Full Duplex, 8-bit MSB, Speed up to 8MHz, Polarity: CPOL Low, CPHA Low, NSS hardware.
	SPI2_MOSI pin	Input	PB15 pin: Slave data Input line, used in Push-pull pull-down mode
	SPI2_MISO pin	Output	PB14 pin: Slave data output line, used in Push-pull pull-down mode
	SPI2_SCK pin	Input	PB13 pin: Slave clock line, used in Push-pull pull-down mode
	SPI2_NSS pin	Input	PB12 pin: Slave Chip Select pin used in Push-pull pull-up mode.
SPI3 bootloader	SPI3	Enabled	The SPI3 configuration is: Slave mode, Full Duplex, 8-bit MSB, Speed up to 8MHz, Polarity: CPOL Low, CPHA Low, NSS hardware.
	SPI3_MOSI pin	Input	PC12 pin: Slave data Input line, used in Push-pull pull-down mode
	SPI3_MISO pin	Output	PC11 pin: Slave data output line, used in Push-pull pull-down mode
	SPI3_SCK pin	Input	PC10 pin: Slave clock line, used in Push-pull pull-down mode
	SPI3_NSS pin	Input	PA15 pin: Slave Chip Select pin used in Push-pull pull-up mode.

Table 56. STM32F401xD(E) configuration in System memory boot mode (continued)

Bootloader	Feature/Peripheral	State	Comment
DFU bootloader	USB_OTG_FS	Enabled	USB OTG FS configured in Forced Device mode. USB_OTG_FS interrupt vector is enabled and used for USB DFU communications.
	USB_OTG_FS_DM pin	Input	PA11 pin: USB OTG FS DM line
	USB_OTG_FS_DP pin	Output	PA12pin: USB OTG FS DP line
	TIM11	Enabled	This timer is used to determine the value of the external clock frequency. Once the external clock frequency is determined, the RCC system is configured to operate at 60 MHz system clock (using PLL).

The system clock is derived from the embedded internal high-speed RC for USARTx, I2Cx and SPIx bootloaders. This internal clock is also used for CAN and DFU (USB FS Device) but only for the selection phase. An external clock multiple of 1 MHz (between 4 and 26 MHz) is required for CAN and DFU bootloader execution after the selection phase.

26.2 Bootloader selection

The figures below shows the bootloader selection mechanism.

Figure 33. Bootloader selection for STM32F401xD(E)

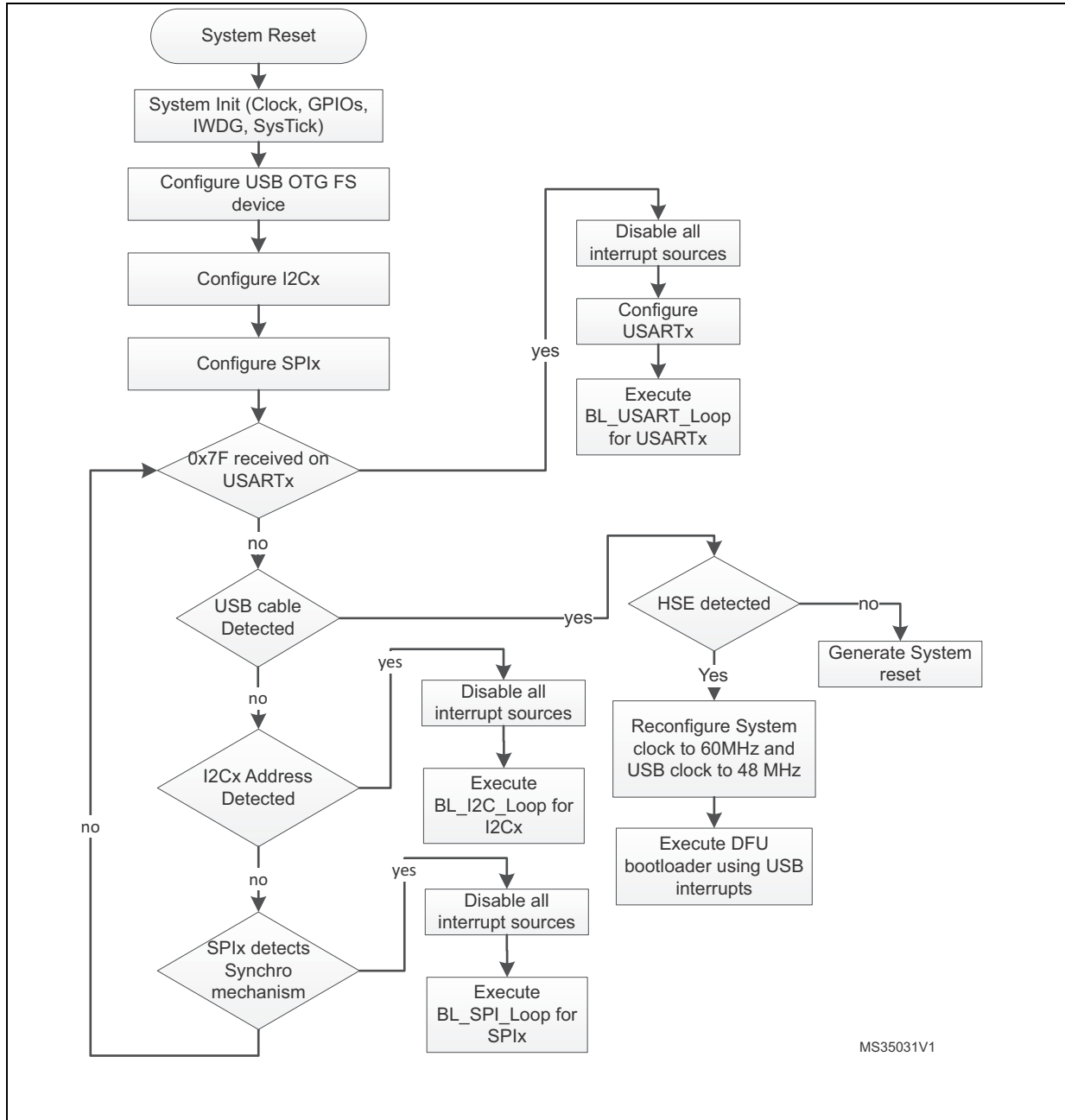

MS35031V1

26.3 Bootloader version

The following table lists the STM32F401xD(E) bootloader version.

Table 57. STM32F401xD(E) bootloader version

Bootloader version number	Description	Known limitations
V13.1	Initial bootloader version.	None

27 STM32L1xxx6(8/B)A devices bootloader

27.1 Bootloader configuration

The STM32L1xxx6(8/B)A bootloader is activated by applying pattern1 (described in [Table 2: Bootloader activation patterns](#)). The following table shows the hardware resources used by this bootloader.

Table 58. STM32L1xxx6(8/B)A configuration in System memory boot mode

Bootloader	Feature/peripheral	State	Comment
Common to all bootloaders	Clock source	HSI enabled	The system clock is equal to 16 MHz.
	RAM	-	2 Kbytes starting from address 0x20000000 are used by the bootloader firmware.
	System memory	-	4 Kbytes starting from address 0x1FF00000 contain the bootloader firmware.
	IWDG	-	The independent watchdog (IWDG) prescaler is configured to its maximum value and is periodically refreshed to prevent watchdog reset (in case the hardware IWDG option was previously enabled by the user).
	Power	-	Voltage range is set to Voltage Range 1.
USART1 bootloader	USART1	Enabled	Once initialized, the USART1 configuration is: 8 bits, even parity and 1 Stop bit.
	USART1_RX pin	Input	PA10 pin: USART1 receives.
	USART1_TX pin	Output	PA9 pin: USART1 transmits.
USART2 bootloader	USART2	Enabled	Once initialized, the USART2 configuration is: 8 bits, even parity and 1 Stop bit.
	USART2_RX pin	Input	PD06 pin: USART2 receives.
	USART2_TX pin	Output	PD05 pin: USART2 transmits.
USART1 and USART2 bootloaders	SysTick timer	Enabled	Used to automatically detect the serial baud rate from the host.

The system clock is derived from the embedded internal high-speed RC, no external quartz is required for the bootloader execution.

27.2 Bootloader selection

The figure below shows the bootloader detection mechanism.

Figure 34. Bootloader selection for STM32L1xxx6(8/B)A devices

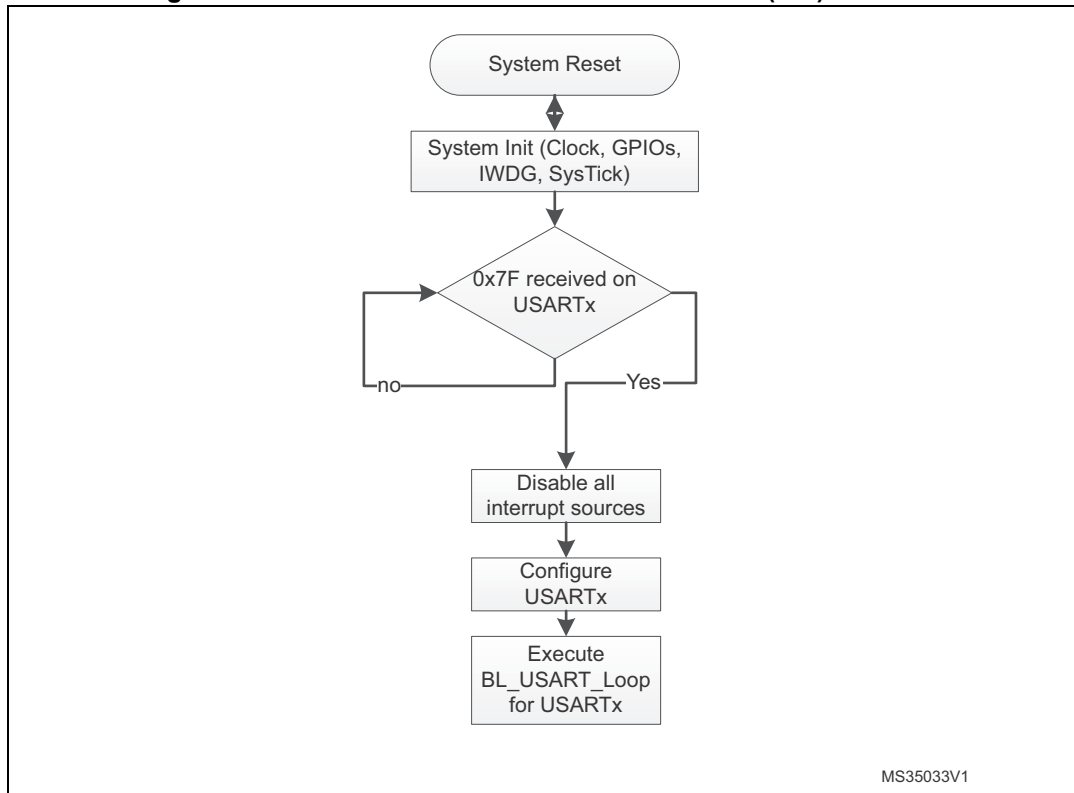

27.3 Bootloader version

The following table lists the STM32L1xxx6(8/B)A bootloader versions:

Table 59. STM32L1xxx6(8/B)A bootloader versions

Bootloader version number	Description	Known limitations
V2.0	Initial bootloader version.	When a Read Memory command or Write Memory command is issued with an unsupported memory address and a correct address checksum (ie. address 0x6000 0000), the command is aborted by the bootloader device, but the NACK (0x1F) is not sent to the host. As a result, the next 2 bytes (which are the number of bytes to be read/written and its checksum) are considered as a new command and its checksum. ⁽¹⁾

1. If the “number of data - 1” (N-1) to be read/written is not equal to a valid command code, then the limitation is not perceived from the host since the command is NACKed anyway (as an unsupported new command).

28 STM32L1xxxE devices bootloader

28.1 Bootloader configuration

The STM32L1xxxE bootloader is activated by applying pattern4 (described in [Table 2: Bootloader activation patterns](#)). The following table shows the hardware resources used by this bootloader.

Table 60. STM32L1xxxE configuration in System memory boot mode

Bootloader	Feature/Peripheral	State	Comment
Common to all bootloaders	RCC	HSI enabled	The system clock frequency is 16 MHz using the HSI. This is used only for USART1 and USART2 bootloaders and during USB detection for DFU bootloader (once the DFU bootloader is selected, the clock source will be derived from the external crystal).
		HSE enabled	The external clock is mandatory only for DFU bootloader and it must be in the following range: [24, 16, 12, 8, 6, 4, 3, 2] MHz. The PLL is used to generate the USB 48 MHz clock and the 32 MHz clock for the system clock.
		-	The clock security system (CSS) interrupt is enabled for the DFU bootloader. Any failure (or removal) of the external clock generates system reset.
	IWDG	-	The independent watchdog (IWDG) prescaler is configured to its maximum value and is periodically refreshed to prevent watchdog reset (in case the hardware IWDG option was previously enabled by the user).
	Power		Voltage range is set to Voltage Range 1.
	System memory	-	8 Kbytes starting from address 0x1FF0 0000. This area contains the bootloader firmware.
	RAM	-	4 Kbytes starting from address 0x20000000 are used by the bootloader firmware.
USART1 bootloader	USART1	Enabled	Once initialized, the USART1 configuration is: 8 bits, even parity and 1 Stop bit.
	USART1_RX pin	Input	PA10 pin: USART1 in reception mode
	USART1_TX pin	Output	PA9 pin: USART1 in transmission mode
USART1 and USART2 bootloaders	SysTick timer	Enabled	Used to automatically detect the serial baud rate from the host for USARTx bootloader.

Table 60. STM32L1xxxE configuration in System memory boot mode (continued)

Bootloader	Feature/Peripheral	State	Comment
USART2 bootloader	USART2	Enabled	Once initialized, the USART2 configuration is: 8 bits, even parity and 1 Stop bit. The USART2 uses its remapped pins.
	USART2_RX pin	Input	PD6 pin: USART2 in reception mode
	USART2_TX pin	Output	PD5 pin: USART2 in transmission mode
DFU bootloader	USB_DM pin	Input or alternate function, automatically controlled by the USB	PA11: USB Send-Receive data line
	USB_DP pin		PA12: USB Send-Receive data line
	Interrupts	Enabled	USB Low Priority interrupt vector is enabled and used for USB DFU communication.

The system clock is derived from the embedded internal high-speed RC for USARTx bootloader. This internal clock is used also for DFU bootloader but only for the selection phase. An external clock in the range of [24, 16, 12, 8, 6, 4, 3, 2] MHz is required for DFU bootloader execution after the selection phase.

28.2 Bootloader selection

The figure below shows the bootloader detection mechanism.

Figure 35. Bootloader selection for STM32L1xxxE devices

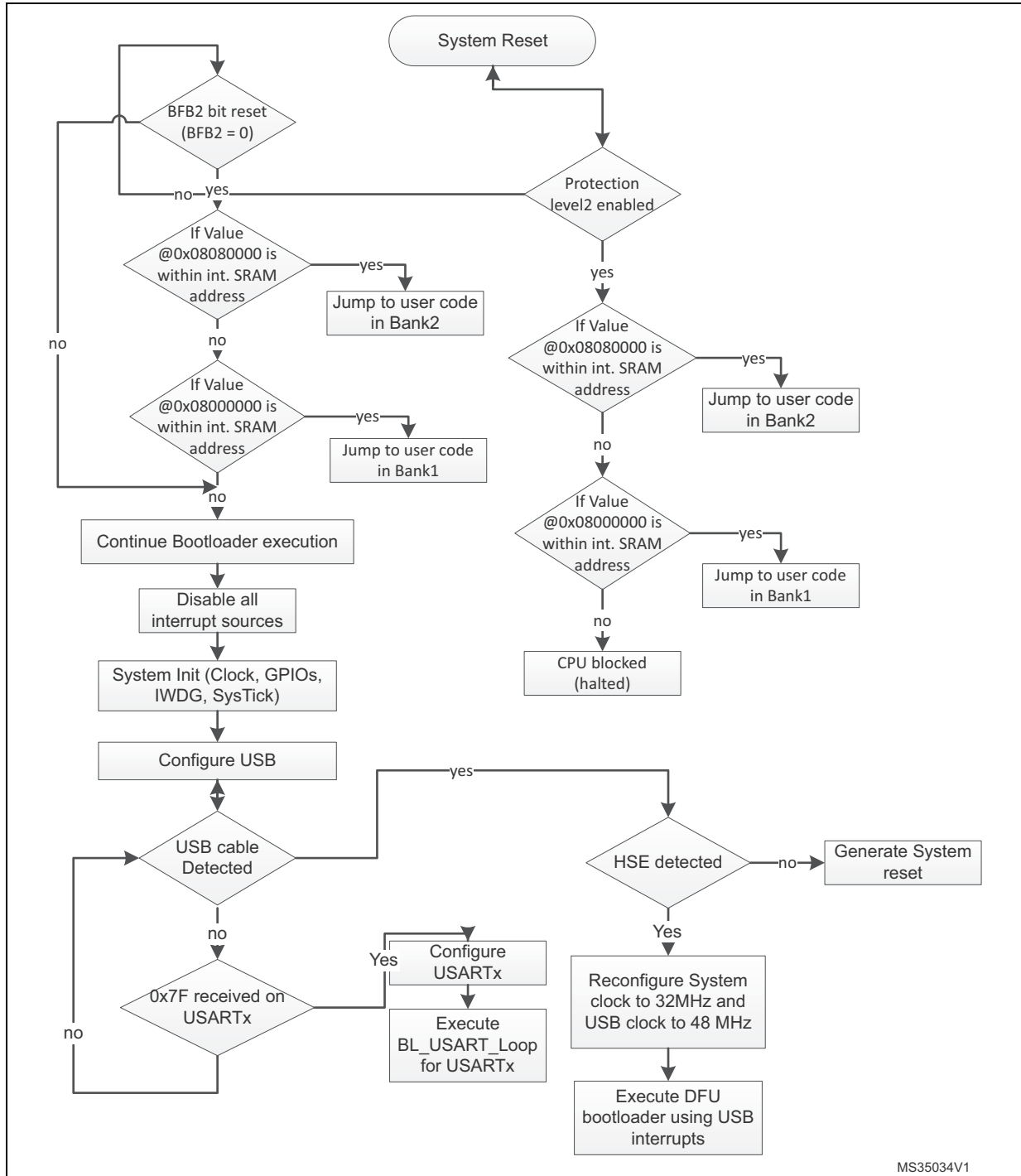

MS35034V1

28.3 Bootloader version

The following table lists the STM32L1xxxE devices bootloader versions:

Table 61. STM32L1xxxE bootloader versions

Bootloader version number	Description	Known limitations
V4.0	Initial bootloader version.	– For the USART interface, two consecutive NACKs (instead of 1 NACK) are sent when a Read Memory or Write Memory command is sent and the RDP level is active.

29 STM32L05xxx/06xxx devices bootloader

29.1 Bootloader configuration

The STM32L05xxx/06xxx bootloader is activated by applying pattern1 (described in [Table 2: Bootloader activation patterns](#)). The following table shows the hardware resources used by this bootloader.

Table 62. STM32L05xxx/06xxx configuration in System memory boot mode

Bootloader	Feature/Peripheral	State	Comment
Common to all bootloaders	RCC	HSI (16MHz) enabled	The system clock is equal to 32 MHz with HSI 16 MHz as clock source.
	Power		Voltage range is set to Voltage Range 1.
	RAM	-	4 Kbytes starting from address 0x20000000 are used by the bootloader firmware
	System memory	-	4 Kbytes starting from address 0x1FF00000, contain the bootloader firmware
	IWDG	-	The independent watchdog (IWDG) prescaler is configured to its maximum value. It is periodically refreshed to prevent watchdog reset (in case the hardware IWDG option was previously enabled by the user).
USART1 bootloader	USART1	Enabled	Once initialized the USART1 configuration is: 8-bits, even parity and 1 Stop bit
	USART1_RX pin	Input	PA10 pin: USART1 in reception mode
	USART1_TX pin	Output	PA9 pin: USART1 in transmission mode
USART2 bootloader	USART2	Enabled	Once initialized the USART2 configuration is: 8-bits, even parity and 1 Stop bit
	USART2_RX pin	Input	PA2 pin: USART2 in reception mode
	USART2_TX pin	Output	PA3 pin: USART2 in transmission mode
USART1 and USART2 bootloaders	SysTick timer	Enabled	Used to automatically detect the serial baud rate from the host for USARTx bootloaders.

Bootloader	Feature/Peripheral	State	Comment
SPI1 bootloader	SPI1	Enabled	The SPI1 configuration is: Slave mode, Full Duplex, 8-bit MSB, Speed up to 8MHz, Polarity: CPOL Low, CPHA Low, NSS hardware.
	SPI1_MOSI pin	Input	PA7 pin: Slave data Input line, used in Push-pull pull-down mode
	SPI1_MISO pin	Output	PA6 pin: Slave data output line, used in Push-pull pull-down mode
	SPI1_SCK pin	Input	PA5 pin: Slave clock line, used in Push-pull pull-down mode
	SPI1_NSS pin	Input	PA4 pin: Slave Chip Select pin used in Push-pull pull-up mode.
SPI2 bootloader	SPI2	Enabled	The SPI2 configuration is: Slave mode, Full Duplex, 8-bit MSB, Speed up to 8MHz, Polarity: CPOL Low, CPHA Low, NSS hardware.
	SPI2_MOSI pin	Input	PB15 pin: Slave data Input line, used in Push-pull pull-down mode
	SPI2_MISO pin	Output	PB14 pin: Slave data output line, used in Push-pull pull-down mode
	SPI2_SCK pin	Input	PB13 pin: Slave clock line, used in Push-pull pull-down mode
	SPI2_NSS pin	Input	PB12 pin: Slave Chip Select pin used in Push-pull pull-up mode.

The system clock is derived from the embedded internal high-speed RC for all bootloader interfaces. No external quartz is required for bootloader operations.

29.2 Bootloader selection

The figure below shows the bootloader detection mechanism.

Figure 36. Bootloader selection for STM32L05xxx/06xxx

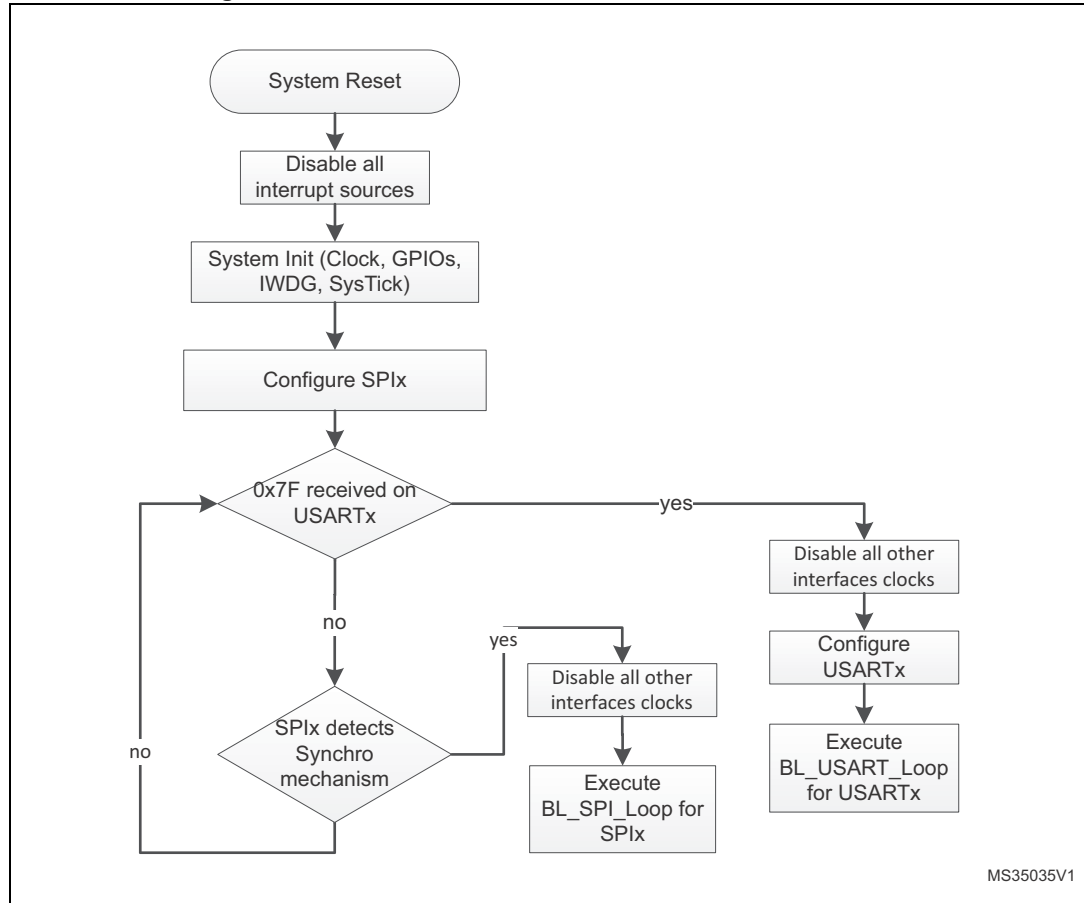

29.3 Bootloader version

The following table lists the STM32L05xxx/06xxx bootloader versions:k

Table 63. STM32L05xxx/06xxx bootloader versions

Bootloader version number	Description	Known limitations
V12.0	Initial bootloader version	none

30 Device-dependent bootloader parameters

The bootloader protocol's command set and sequences for each serial peripheral are the same for all STM32 devices. However, some parameters depend on device and bootloader version:

- PID (product ID)
- Valid RAM memory addresses (RAM area used during bootloader execution is not accessible) accepted by the bootloader when the Read Memory, Go and Write Memory commands are requested.
- System Memory area (BIF): where the Bootloader is located.

The table below shows the values of these parameters for each STM32 device bootloader in production.

Table 64. Bootloader device-dependent parameters

STM32 series	Device	PID	BL ID	RAM memory	System memory
F0	STM32F051xx	0x440	0x21	0x20000800 - 0x20001FFF	0x1FFFE000 - 0x1FFFF7FF
	STM32F031xx	0x444	0x10	0x20000800 - 0x20000FFF	
	STM32F042xx	0x445	0xA0	N.A	0x1FFFC400 - 0x1FFFF7FF
	STM32F072xx	0x448	0xA1	0x20001800 - 0x20003FFF	0x1FFFC800 - 0x1FFFF7FF
F1	STM32F10xxx	Low-density	0x412	NA	0x1FFFF000 - 0x1FFFF7FF
		Medium-density	0x410	NA	
		High-density	0x414	NA	
		Medium-density value line	0x420	0x10	
		High-density value line	0x428	0x10	
	STM32F105xx/107xx	0x418	NA	0x20001000 - 0x2000FFFF	0x1FFFB000 - 0x1FFFF7FF
STM32F10xxx XL-density	0x430	0x21	0x20000800 - 0x20017FFF	0x1FFFE000 - 0x1FFFF7FF	
F2	STM32F2xxxx	0x411	0x20	0x20002000 - 0x2001FFFF	0x1FFF0000 - 0x1FFF77FF
			0x33		
F3	STM32F373xx	0x432	0x41	0x20001400 - 0x20007FFF	0x1FFFD800 - 0x1FFFF7FF
	STM32F378xx		0x50	0x20001000 - 0x20007FFF	
	STM32F302xB(C)/303xB(C)	0x422	0x41	0x20001400 - 0x20009FFF	
	STM32F358xx		0x50		
	STM32F301xx/302x4(6/8)	0x439	0x40	0x20001800 - 0x20003FFF	
	STM32F318xx		0x50		
	STM32F303x4(6/8)/334xx/328xx	0x438	0x50	0x20001800 - 0x20002FFF	

Table 64. Bootloader device-dependent parameters (continued)

STM32 series	Device	PID	BL ID	RAM memory	System memory
F4	STM32F40xx/41xxx	0x413	0x31	0x20002000 - 0x2001FFFF	0x1FFF0000 - 0x1FFF77FF
			0x90	0x20003000 - 0x2001FFFF	
	STM32F427xx/437xx	0x419	0x30	0x20002000 - 0x2002FFFF	
	STM32F429xx/439xx	0x419	0x70	0x20003000 - 0x2002FFFF	
			0x90		
	STM32F401xB(C)	0x423	0xD1	0x20003000 - 0x2000FFFF	
STM32F401xD(E)	0x433	0xD1	0x20003000 - 0x20017FFF		
L0	STM32L05xxx/06xxx	0x417	0xC0	0x20001000 - 0x20001FFF	0x1FF00000 - 0x1FF00FFF
L1	STM32L1xxx6(8/B)	0x416	0x20	0x20000800 - 0x20003FFF	
	STM32L1xxx6(8/B)A	0x429	0x20	0x20001000 - 0x20007FFF	
	STM32L1xxxC	0x427	0x40		
	STM32L1xxxD	0x436	0x45	0x20001000 - 0x2000BFFF	0x1FF00000 - 0x1FF01FFF
	STM32L1xxxE	0x437	0x40	0x20001000 - 0x20013FFF	

31 Bootloader timing

This section presents the typical timings of the bootloader firmware that should be used to ensure correct synchronization between host and STM32 device.

Two types of timings will be described herein:

- STM32 device bootloader resources initialization duration.
- Communication interface selection duration.

After these timings the bootloader is ready to receive and execute host commands.

31.1 Bootloader Startup timing

After bootloader reset, the host should wait until the STM32 bootloader is ready to start detection phase with a specific interface communication. This time corresponds to bootloader startup timing, during which resources used by bootloader are initialized.

Figure 37. Bootloader Startup timing description

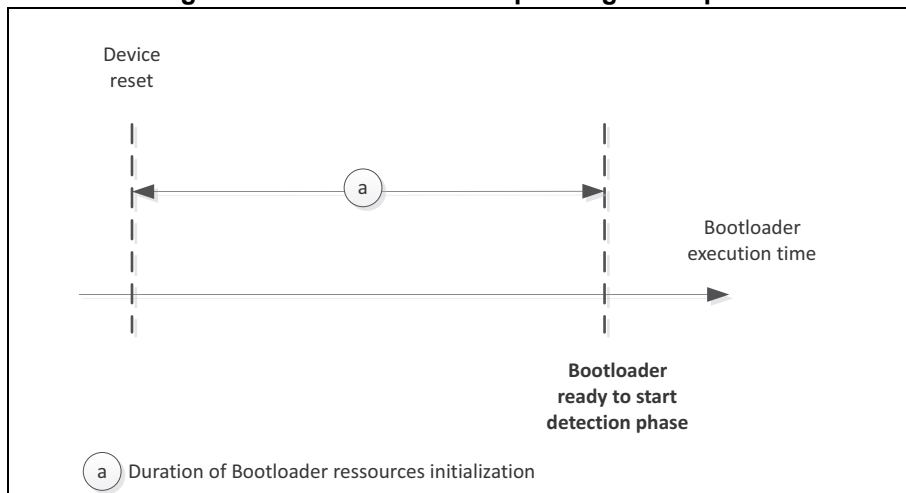

The table below contains the minimum startup timing for each STM32 product:

Table 65. Bootloader startup timings of STM32 devices

Device	Minimum bootloader Startup (ms)	HSE Timeout (ms)
STM32F10xxx	1.227	N.A
STM32F105xx/107xx	PA9 pin low	N.A
	PA9 pin High	
STM32F10xxx XL-density	1.227	N.A
STM32L1xxx6(8/B)	0.542	N.A
STM32L1xxxC	0.708	80
STM32L1xxxD	0.708	80

Table 65. Bootloader startup timings of STM32 devices (continued)

Device		Minimum bootloader Startup (ms)	HSE Timeout (ms)
STM32F2xxxx	V2.x	134	N.A
	V3.x	84.59	0.790
STM32F40xxx/41xxx	V3.x	84.59	0.790
	V9.x	74	96
STM32F051xx		1.612	N.A
STM32F031xx		1.612	N.A
STM32F373xx	HSE connected	43.4	2.236
	HSE not connected	2.36	
STM32F302xB(C)/303xB(C)	HSE connected	43.4	2.236
	HSE not connected	2.36	
STM32F378xx		1.542	N.A
STM32F358xx		1.542	N.A
STM32F427xx/437xx		82	0.790
STM32F429xx/439xx	V7.x	82	97
	V9.x	74	97
STM32F042xx		0.058	N.A
STM32F072xx		0.058	N.A
STM32F301xx/302x4(6/8)	HSE connected	45	560.5
	HSE not connected	560.8	
STM32F318xx		0.182	N.A
STM32F303x4(6/8)/334xx/328xx		0.155	N.A
STM32F401xB(C)		74.5	85
STM32F401xD(E)		74.5	85
STM32L1xxx6(8/B)A		0.542	N.A
STM32L1xxxE		0.708	200
STM32L05xxx/06xxx		0.22	N.A

31.2 USART connection timing

Usart connection timing is the time that host should wait for between sending the synchronization data (0x7F) and receiving the first acknowledge response (0x79).

Figure 38. USART connection timing description

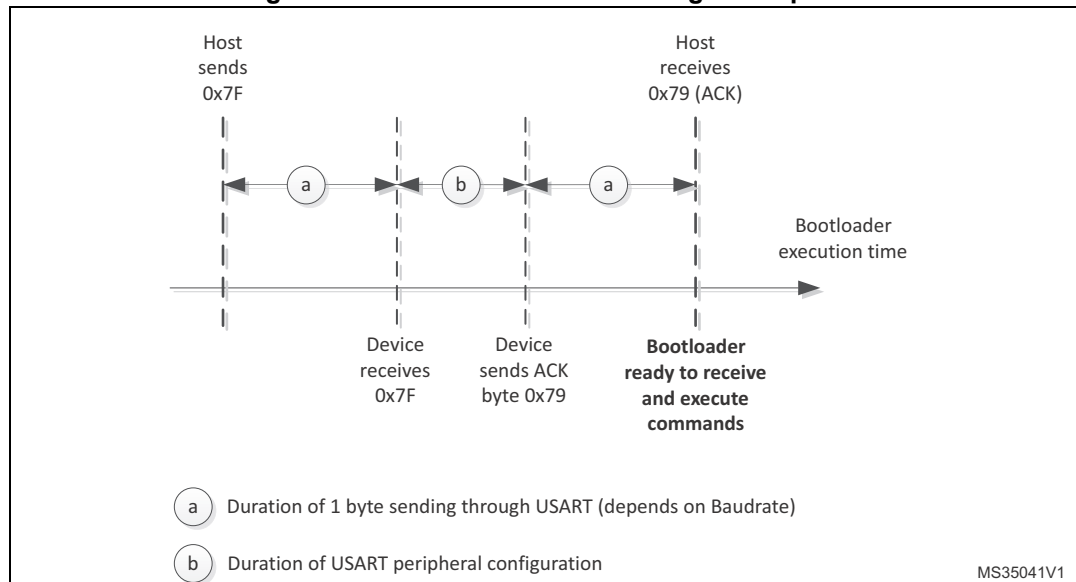

Note: For STM32F105xx/107xx line devices, PA9 pin (USB_VBUS) is used to detect the USB host connection. The initialization of USB peripheral is performed only if PA9 is high at detection phase which means that a host is connected to the port and delivering 5 V on the USB bus. When PA9 level is high at detection phase, more time is required to initialize and shutdown the USB peripheral. To minimize bootloader detection time when PA9 pin is not used, keep PA9 state low during USART detection phase from the moment the device is reset till a device ACK is sent.

Table 66. USART bootloader minimum timings of STM32 devices

Device	One USART byte sending (ms)	USART configuration (ms)	USART connection (ms)
STM32F10xxx	0.078125	0.002	0.15825
STM32F105xx/107xx	0.078125	PA9 pin low	0.16325
		PA9 pin High	105.15625
STM32F10xxx XL-density	0.078125	0.006	0.16225
STM32L1xxx6(8/B)	0.078125	0.008	0.16425
STM32L1xxxC	0.078125	0.008	0.16425
STM32L1xxxD	0.078125	0.008	0.16425
STM32F2xxxx	0.078125	V2.x	0.16525
		V3.x	

Table 66. USART bootloader minimum timings of STM32 devices (continued)

Device		One USART byte sending (ms)	USART configuration (ms)	USART connection (ms)
STM32F40xxx/41xxx	V3.x	0.078125	0.009	0.16525
	V9.x		0.0035	0.15975
STM32F051xx		0.078125	0.0095	0.16575
STM32F031xx		0.078125	0.0064	0.16265
STM32F373xx	HSE connected	0.078125	0.002	0.15825
	HSE not connected			
STM32F302xB(C)/303xB(C)	HSE connected	0.078125	0.002	0.15825
	HSE not connected			
STM32F378xx		0.15625	0.001	0.3135
STM32F358xx		0.15625	0.001	0.3135
STM32F427xx/437xx		0.078125	0.007	0.16325
STM32F429xx/439xx	V7.x	0.078125	0.007	0.16325
	V9.x		0.00326	0.15951
STM32F042xx		0.078125	0.007	0.16325
STM32F072xx		0.078125	0.007	0.16325
STM32F301xx/302x4(6/8)	HSE connected	0.078125	0.002	0.15825
	HSE not connected			
STM32F318xx		0.078125	0.002	0.15825
STM32F303x4(6/8)/334xx/328xx		0.078125	0.002	0.15825
STM32F401xB(C)		0.078125	0.00326	0.15951
STM32F401xD(E)		0.078125	0.00326	0.15951
STM32L1xxx6(8/B)A		0.078125	0.008	0.16425
STM32L1xxxE		0.078125	0.008	0.16425
STM32L05xxx/06xxx		0.078125	0.018	0.17425

31.3 USB connection timing

USB connection timing is the time that host should wait for between plugging the usb cable and establishing a correct connection with device. This timing includes enumeration and DFU components configuration. USB connection depends on the host.

Figure 39. USB connection timing description

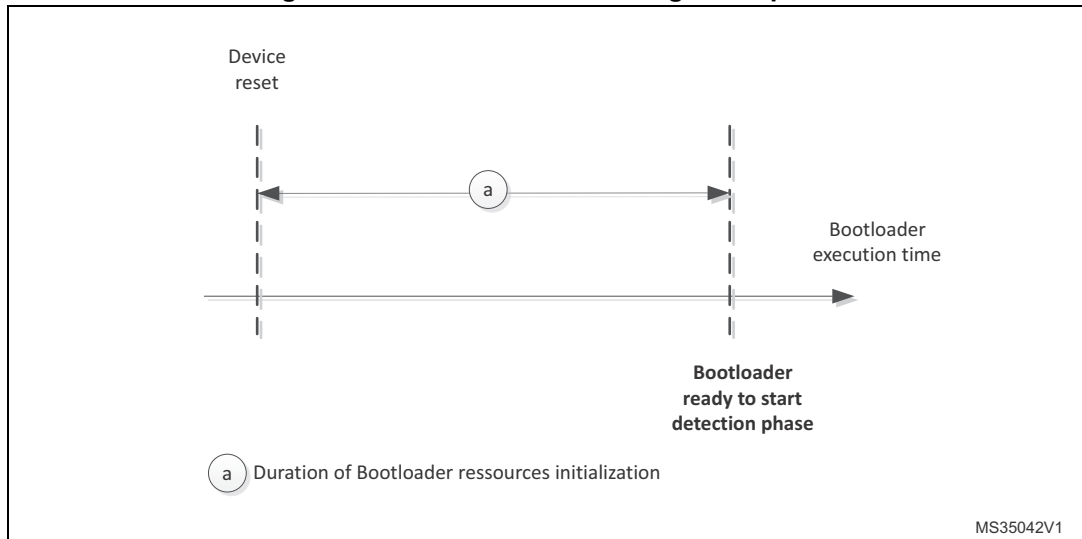

Note: For STM32F105xx/107xx devices, if the external HSE crystal frequency is different from 25 MHz (14.7456 MHz or 8 MHz), the device performs several unsuccessful enumerations (with connect – disconnect sequences) before being able to establish a correct connection with the host. This is due to the HSE automatic detection mechanism based on SOF detection.

Table 67. USB bootloader minimum timings of STM32 devices

Device		USB connection (ms)
STM32F105xx/107xx	HSE = 25 MHz	460
	HSE = 14.7465 MHz	4500
	HSE = 8 MHz	13700
STM32L1xxxC		849
STM32L1xxxD		849
STM32F2xxxx		270
STM32F40xxx/41xxx	V3.x	270
	V9.x	250
STM32F373xx		300
STM32F302xB(C)/303xB(C)		300
STM32F427xx/437xx		270
STM32F429xx/439xx	V7.x	250
	V9.x	250
STM32F042xx		350
STM32F072xx		350
STM32F301xx/302x4(6/8)		300
STM32F401xB(C)		250
STM32F401xD(E)		250

31.4 I2C connection timing

I2C connection timing is the time that host should wait for between sending I2C device address and sending command code. This timing includes I2C line stretching duration.

Figure 40. I2C connection timing description

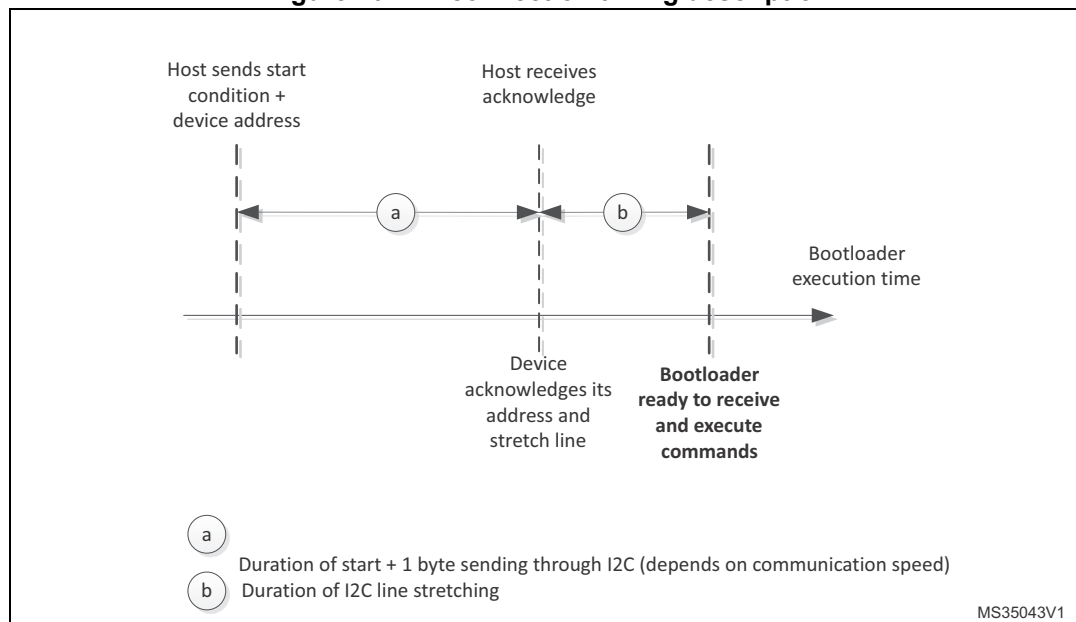

Note: For I2C communication, a timeout mechanism is implemented and it must be respected to execute bootloader commands correctly. This timeout is implemented between two I2C frame in the same command (eg: for Write memory command a timeout is inserted between command sending frame and address memory sending frame). Also the same timeout period is inserted between two successive data reception or transmission in the same I2C frame. If the timeout period is elapsed a system reset is generated to avoid bootloader crash.

In erase memory command and read-out unprotect command, the duration of flash operation should be taken into consideration when implementing the host side. After sending the code of pages to be erased, the host should wait until the bootloader device performs page erasing to complete the remaining steps of erase command.

Table 68. I2C bootloader minimum timings of STM32 devices

Device	Start condition + one I2C byte sending (ms)	I2C line stretching (ms)	I2C connection (ms)	I2C Timeout (ms)
STM32F40xxx/41xxx	0.0225	0.0022	0.0247	1000
STM32F378xx	0.0225	0.0055	0.028	10
STM32F358xx	0.0225	0.0055	0.028	10
STM32F429xx/439xx	V7.x	0.0033	0.0258	1000
	V9.x	0.0022	0.0247	
STM32F042xx	0.0225	0.0025	0.025	1000

Table 68. I2C bootloader minimum timings of STM32 devices (continued)

Device	Start condition + one I2C byte sending (ms)	I2C line stretching (ms)	I2C connection (ms)	I2C Timeout (ms)
STM32F072xx	0.0225	0.0025	0.025	1000
STM32F318xx	0.0225	0.0027	0.0252	1000
STM32F303x4(6/8)/334xx/328xx	0.0225	0.0027	0.0252	1000
STM32F401xB(C)	0.0225	0.0022	0.0247	1000
STM32F401xD(E)	0.0225	0.0022	0.0247	1000

31.5 SPI connection timing

SPI connection timing is the time that host should wait for between sending the synchronization data (0xA5) and receiving the first acknowledge response (0x79).

Figure 41. SPI connection timing description

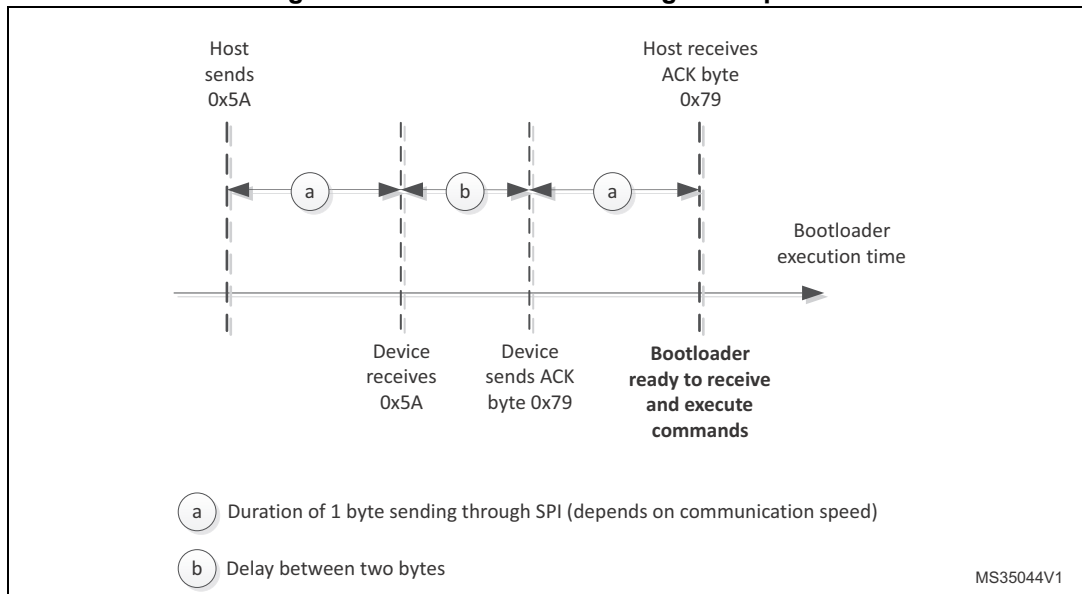

Table 69. SPI bootloader minimum timings of STM32 devices

Device	One SPI byte sending (ms)	Delay between two bytes(ms)	SPI connection (ms)
All products	0.001	0.008	0.01

32 Revision history

Table 70. Document revision history

Date	Revision	Changes
22-Oct-2007	1	Initial release.
22-Jan-2008	2	All STM32 in production (rev. B and rev. Z) include the bootloader described in this application note. Modified: Section 3.1: Bootloader activation and Section 1.4: Bootloader code sequence . Added: Section 1.3: Hardware requirements , Section 1.5: Choosing the USART baud rate , Section 1.6: Using the bootloader and Section . Note 2 linked to Get, Get Version & Read Protection Status and Get ID commands in Table 3: Bootloader commands , Note 3 added. Notion of “permanent” (Permanent Write Unprotect/Readout Protect/Unprotect) removed from document. Small text changes. Bootloader version upgraded to 2.0.
26-May-2008	3	Small text changes. RAM and System memory added to Table : The system clock is derived from the embedded internal high-speed RC, no external quartz is required for the bootloader execution. Section 1.6: Using the bootloader on page 8 removed. Erase modified, Note 3 modified and Note 1 added in Table 3: Bootloader commands on page 9 . Byte 3: on page 11 modified. Byte 2: on page 13 modified. Byte 2; Bytes 3-4: and Byte 5: on page 15 modified, Note 3 modified. Byte 8: on page 18 modified. Notes added to Section 2.5: Go command on page 18 . Figure 11: Go command: device side on page 20 modified. Note added in Section 2.6: Write Memory command on page 21 . Byte 8: on page 24 modified. Figure 14: Erase Memory command: host side and Figure 15: Erase Memory command: device side modified. Byte 3: on page 26 modified. Table 3: Bootloader commands on page 9 . Note modified and note added in Section 2.8: Write Protect command on page 27 . Figure 16: Write Protect command: host side , Figure 17: Write Protect command: device side , Figure 19: Write Unprotect command: device side , Figure 21: Readout Protect command: device side and Figure 23: Readout Unprotect command: device side modified.
29-Jan-2009	4	This application note also applies to the STM32F102xx microcontrollers. Bootloader version updated to V2.2 (see Table 4: Bootloader versions).

Table 70. Document revision history (continued)

Date	Revision	Changes
19-Nov-2009	5	<p>IWDG added to Table : The system clock is derived from the embedded internal high-speed RC, no external quartz is required for the bootloader execution.. Note added.</p> <p>BL changed bootloader in the entire document.</p> <p>Go command description modified in Table : The system clock is derived from the embedded internal high-speed RC, no external quartz is required for the bootloader execution..</p> <p>Number of bytes awaited by the bootloader corrected in Section 2.4: Read Memory command.</p> <p>Note modified below Figure 10: Go command: host side.</p> <p>Note removed in Section 2.5: Go command and note added.</p> <p>Start RAM address specified and note added in Section 2.6: Write Memory command. All options are erased when a Write Memory command is issued to the Option byte area.</p> <p>Figure 11: Go command: device side modified.</p> <p>Figure 13: Write Memory command: device side modified.</p> <p>Note added and bytes 3 and 4 sent by the host modified in Section 2.7: Erase Memory command.</p> <p>Note added to Section 2.8: Write Protect command.</p>
09-Mar-2010	6	<p>Application note restructured. Value line and connectivity line device bootloader added (Replaces AN2662).</p> <p>Introduction changed. Glossary added.</p>
20-Apr-2010	7	<p>Related documents: added XL-density line datasheets and programming manual.</p> <p>Glossary: added XL-density line devices.</p> <p>Table 3: added information for XL-density line devices.</p> <p>Section 4.1: Bootloader configuration: updated first sentence.</p> <p>Section 5.1: Bootloader configuration: updated first sentence.</p> <p>Added Section 6: STM32F10xxx XL-density devices bootloader.</p> <p>Table 65: added information for XL-density line devices.</p>
08-Oct-2010	8	<p>Added information for high-density value line devices in Table 3 and Table 65.</p>
14-Oct-2010	9	<p>Removed references to obsolete devices.</p>
26-Nov-2010	10	<p>Added information on ultralow power devices.</p>
13-Apr-2011	11	<p>Added information related to STM32F205/215xx and STM32F207/217xx devices.</p> <p>Added Section 32: Bootloader timing</p>
06-Jun-2011	12	<p>Updated:</p> <ul style="list-style-type: none"> – Table 12: STM32L1xxx6(8/B) bootloader versions – Table 17: STM32F2xxxx configuration in System memory boot mode – Table 18: STM32F2xxxx bootloader V2.x versions – Table 20: STM32F2xxxx bootloader V3.x versions

Table 70. Document revision history (continued)

Date	Revision	Changes
28-Nov-2011	13	<p>Added information related to STM32F405/415xx and STM32F407/417xx bootloader, and STM32F105xx/107xx bootloader V2.1.</p> <p>Added value line devices in Section 4: STM32F10xxx devices bootloader title and overview.</p>
30-Jul-2012	14	<p>Added information related to STM32F051x6/STM32F051x8 and to High-density ultralow power STM32L151xx, STM32L152xx bootloader.</p> <p>Added case of BOOT1 bit in Section 3.1: Bootloader activation.</p> <p>Updated Connectivity line, High-density ultralow power line, STM32F2xx and STM32F4xx in Table 3: Embedded bootloaders.</p> <p>Added bootloader version V2.2 in Table 8: STM32F105xx/107xx bootloader versions.</p> <p>Added bootloader V2.2 in Section 5.3.1: How to identify STM32F105xx/107xx bootloader versions.</p> <p>Added note related to DFU interface below Table 15: STM32L1xxxx high-density configuration in System memory boot mode. Added V4.2 bootloader know limitations and updated description, and added V4.5 bootloader in Table 16: STM32L1xxxx high-density bootloader versions.</p> <p>Added note related to DFU interface below Table 19: STM32F2xxxx configuration in System memory boot mode. Added V3.2 bootloader know limitations, and added V3.3 bootloader in Table 20: STM32F2xxxx bootloader V3.x versions. Updated STM32F2xx and STM32F4xx system memory end address in Table 21: STM32F40xxx/41xxx configuration in System memory boot mode.</p> <p>Added note related to DFU interface below Table 21: STM32F40xxx/41xxx configuration in System memory boot mode.</p> <p>Added V3.0 bootloader know limitations, and added V3.1 bootloader in Table 22: STM32F40xxx/41xxx bootloader V3.x version.</p> <p>Added bootloader V2.1 know limitations in Table 26: STM32F051xx bootloader versions.</p> <p>Updated STM32F051x6/x8 system memory end address in Table 65: Bootloader device-dependent parameters.</p> <p>Added Table 75: USART bootloader timings for high-density ultralow power devices, and Table 78: USART bootloader timings for STM32F051xx devices.</p> <p>Added Table 88: USB minimum timings for high-density ultralow power devices.</p>

Table 70. Document revision history (continued)

Date	Revision	Changes
24-Jan-2013	15	<p>Updated generic product names throughout the document (see Glossary).</p> <p>Added the following new sections:</p> <ul style="list-style-type: none"> – Section 8: STM32L1xxxC devices bootloader. – Section 13: STM32F031xx devices bootloader. – Section 14: STM32F373xx devices bootloader. – Section 15: STM32F302xB(C)/303xB(C) devices bootloader. – Section 16: STM32F378xx devices bootloader. – Section 17: STM32F358xx devices bootloader. – Section 18: STM32F427xx/437xx devices bootloader. – Section 34.3: I2C bootloader timing characteristics. <p>Updated Section 1: Related documents and Section 2: Glossary.</p> <p>Added Table 79 to Table 85 (USART bootloader timings).</p> <p>Replaced Figure 6 to Figure 16, and Figures 18, 19 and 42.</p> <p>Modified Tables 3, 5, 9, 11, 17, 20, 21, 22 to 13, 27, 29, 31, 33, 35, 37 and 65.</p> <p>Removed "X = 6: one USART is used" in Section 3.3: Hardware connection requirement.</p> <p>Replaced address 0x1FFFF 8002 with address 0x1FFF F802 in Section 12.1: Bootloader configuration.</p> <p>Modified procedure related to execution of the bootloader code in Note: on page 28, in Section 6.2: Bootloader selection and in Section 9.2: Bootloader selection.</p>
06-Feb-2013	16	<p>Added information related to I²C throughout the document.</p> <p>Streamlined Table 1: Applicable products and Section 1: Related documents.</p> <p>Modified Table 3: Embedded bootloaders as follows:</p> <ul style="list-style-type: none"> – Replaced "V6.0" with "V1.0" – Replaced "0x1FFFF7A6" with "0x1FFFF796" in row STM32F31xx – Replaced "0x1FFF7FA6" with "0x1FFFF7A6" in row STM32F051xx <p>Updated figures 6, 9 and 11.</p> <p>Added Note: in Glossary and Note: in Section 3.1: Bootloader activation.</p> <p>Replaced:</p> <ul style="list-style-type: none"> – "1.62 V" with "1.8 V" in tables 17, 19, 19, 22, 21, 27, 37 and 59 – "5 Kbytes" with "4 Kbytes" in row RAM of Table 33 – "127 pages (2 KB each)" with "4 KB (2 pages of 2 KB each)" in rows F3 of Table 65 – "The bootloader ID is programmed in the last two bytes of the device system memory" with "The bootloader ID is programmed in the last byte address - 1 of the device system memory" in Section 3.3: Hardware connection requirement. – "STM32F2xxxx devices revision Y" by "STM32F2xxxx devices revision X and Y" in Section 10: STM32F2xxxx devices bootloader – "Voltage Range 2" with "Voltage Range 1" in tables 11, 15 and 26.

Table 70. Document revision history (continued)

Date	Revision	Changes
21-May-2013	17	Updated: <ul style="list-style-type: none"> – Introduction – Section 2: Glossary – Section 3.3: Hardware connection requirement – Section 7: STM32L1xxx6(8/B) devices bootloader to include STM32L100 value line – Section 32.2: USART connection timing – Section 34.2: USB bootloader timing characteristics – Section 34.3: I2C bootloader timing characteristics – Table 1: Applicable products – Table 3: Embedded bootloaders – Table 25: STM32F051xx configuration in System memory boot mode – Table 27: STM32F031xx configuration in System memory boot mode – Table 65: Bootloader device-dependent parameters – Figure 17: Bootloader selection for STM32F031xx devices Added Section 19: STM32F429xx/439xx devices bootloader .
19-May-2014	18	Add: <ul style="list-style-type: none"> – Figure 1 to Figure 5, Figure 15, Figure 17, Figure 18, Figure 20, Figure 21, from Figure 25 to Figure 37, Figure 41 – Table 4, Table 24, Table 25, from Table 28 to Table 31, from Table 34 to Table 37, from Table 42 to Table 43, from Table to Table 69 – Section 11.2, Section 19.2, Section 31.1, Section 31.5 – Section 13, Section 14, Section 16, Section 17, from Section 20 to Section 29 – note under Figure 1, Figure 2, Figure 3 and Figure 4 Updated: <ul style="list-style-type: none"> – Updated starting from Section 3 to Section 12 and Section 15, Section 18 and Section 19 the chapter structure organized in three subsection: Bootloader configuration, Bootloader selection and Bootloader version. – Updated Section 30 and Section 31 – Updated block diagram of Figure 18 and Figure 19. – Fixed I2C address for STM32F429xx/439xx devices in Table 40 – Table 1, Table 2, Table 3, Table 8, Table 12, Table 14, Table 16, Table 18, Table 20, Table 22, Table 64 – from Figure 6, to Figure 14, Figure 16, from Figure 37 to Figure 41 – note on Table 13

Please Read Carefully:

Information in this document is provided solely in connection with ST products. STMicroelectronics NV and its subsidiaries ("ST") reserve the right to make changes, corrections, modifications or improvements, to this document, and the products and services described herein at any time, without notice.

All ST products are sold pursuant to ST's terms and conditions of sale.

Purchasers are solely responsible for the choice, selection and use of the ST products and services described herein, and ST assumes no liability whatsoever relating to the choice, selection or use of the ST products and services described herein.

No license, express or implied, by estoppel or otherwise, to any intellectual property rights is granted under this document. If any part of this document refers to any third party products or services it shall not be deemed a license grant by ST for the use of such third party products or services, or any intellectual property contained therein or considered as a warranty covering the use in any manner whatsoever of such third party products or services or any intellectual property contained therein.

UNLESS OTHERWISE SET FORTH IN ST'S TERMS AND CONDITIONS OF SALE ST DISCLAIMS ANY EXPRESS OR IMPLIED WARRANTY WITH RESPECT TO THE USE AND/OR SALE OF ST PRODUCTS INCLUDING WITHOUT LIMITATION IMPLIED WARRANTIES OF MERCHANTABILITY, FITNESS FOR A PARTICULAR PURPOSE (AND THEIR EQUIVALENTS UNDER THE LAWS OF ANY JURISDICTION), OR INFRINGEMENT OF ANY PATENT, COPYRIGHT OR OTHER INTELLECTUAL PROPERTY RIGHT.

ST PRODUCTS ARE NOT DESIGNED OR AUTHORIZED FOR USE IN: (A) SAFETY CRITICAL APPLICATIONS SUCH AS LIFE SUPPORTING, ACTIVE IMPLANTED DEVICES OR SYSTEMS WITH PRODUCT FUNCTIONAL SAFETY REQUIREMENTS; (B) AERONAUTIC APPLICATIONS; (C) AUTOMOTIVE APPLICATIONS OR ENVIRONMENTS, AND/OR (D) AEROSPACE APPLICATIONS OR ENVIRONMENTS. WHERE ST PRODUCTS ARE NOT DESIGNED FOR SUCH USE, THE PURCHASER SHALL USE PRODUCTS AT PURCHASER'S SOLE RISK, EVEN IF ST HAS BEEN INFORMED IN WRITING OF SUCH USAGE, UNLESS A PRODUCT IS EXPRESSLY DESIGNATED BY ST AS BEING INTENDED FOR "AUTOMOTIVE, AUTOMOTIVE SAFETY OR MEDICAL" INDUSTRY DOMAINS ACCORDING TO ST PRODUCT DESIGN SPECIFICATIONS. PRODUCTS FORMALLY ESCC, QML OR JAN QUALIFIED ARE DEEMED SUITABLE FOR USE IN AEROSPACE BY THE CORRESPONDING GOVERNMENTAL AGENCY.

Resale of ST products with provisions different from the statements and/or technical features set forth in this document shall immediately void any warranty granted by ST for the ST product or service described herein and shall not create or extend in any manner whatsoever, any liability of ST.

ST and the ST logo are trademarks or registered trademarks of ST in various countries.

Information in this document supersedes and replaces all information previously supplied.

The ST logo is a registered trademark of STMicroelectronics. All other names are the property of their respective owners.

© 2014 STMicroelectronics - All rights reserved

STMicroelectronics group of companies

Australia - Belgium - Brazil - Canada - China - Czech Republic - Finland - France - Germany - Hong Kong - India - Israel - Italy - Japan - Malaysia - Malta - Morocco - Philippines - Singapore - Spain - Sweden - Switzerland - United Kingdom - United States of America

www.st.com

