

The RF Line

NPN Silicon

RF Power Transistor

Designed for 24 Volt UHF large-signal, common emitter, class-AB linear amplifier applications in industrial and commercial FM/AM equipment operating in the range 800–970 MHz.

- Specified 24 Volt, 900 MHz Characteristics
 - Output Power = 30 Watts
 - Minimum Gain = 10.5 dB @ 900 MHz, class-AB
 - Minimum Efficiency = 30% @ 900 MHz, 30 Watts (PEP)
 - Maximum Intermodulation Distortion –30 dBc @ 30 Watts (PEP)
- Characterized with Series Equivalent Large-Signal Parameters from 800 to 960 MHz
- Silicon Nitride Passivated
- 100% Tested for Load Mismatch Stress at all Phase Angles with 5:1 VSWR @ 26 Vdc, and Rated Output Power
- Gold Metalized, Emitter Ballasted for Long Life and Resistance to Metal-Migration

MRF897R

30 W, 900 MHz
RF POWER
TRANSISTOR
NPN SILICON

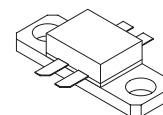

CASE 395E-01, STYLE 1

MAXIMUM RATINGS

Rating	Symbol	Value	Unit
Collector–Emitter Voltage	V_{CEO}	30	Vdc
Collector–Emitter Voltage	V_{CES}	60	Vdc
Emitter–Base Voltage	V_{EBO}	4.0	Vdc
Collector–Current — Continuous	I_C	4.0	Adc
Total Device Dissipation @ $T_C = 25^\circ\text{C}$ Derate above 25°C	P_D	105 0.60	Watts W/ $^\circ\text{C}$
Storage Temperature Range	T_{stg}	–65 to +150	$^\circ\text{C}$

THERMAL CHARACTERISTICS

Characteristic	Symbol	Max	Unit
Thermal Resistance, Junction to Case	$R_{\theta JC}$	1.67	$^\circ\text{C}/\text{W}$

ELECTRICAL CHARACTERISTICS ($T_C = 25^\circ\text{C}$ unless otherwise noted)

Characteristic	Symbol	Min	Typ	Max	Unit
----------------	--------	-----	-----	-----	------

OFF CHARACTERISTICS

Collector–Emitter Breakdown Voltage ($I_C = 50 \text{ mAdc}$, $I_B = 0$)	$V_{(BR)CEO}$	30	33	—	Vdc
Collector–Emitter Breakdown Voltage ($I_C = 50 \text{ mAdc}$, $V_{BE} = 0$)	$V_{(BR)CES}$	60	80	—	Vdc
Emitter–Base Breakdown Voltage ($I_E = 5 \text{ mAdc}$, $I_C = 0$)	$V_{(BR)EBO}$	4.0	4.7	—	Vdc
Collector Cutoff Current ($V_{CE} = 30 \text{ Vdc}$, $V_{BE} = 0$, $T_C = 25^\circ\text{C}$)	I_{CES}	—	—	10.0	mAdc

ON CHARACTERISTICS

DC Current Gain ($I_{CE} = 1.0 \text{ Adc}$, $V_{CE} = 5 \text{ Vdc}$)	h_{FE}	30	80	120	—
---	----------	----	----	-----	---

DYNAMIC CHARACTERISTICS

Output Capacitance ($V_{CB} = 24 \text{ Vdc}$, $I_E = 0$, $f = 1.0 \text{ MHz}$)	C_{ob}	14	21	28	pF
--	----------	----	----	----	----

(continued)

ELECTRICAL CHARACTERISTICS — continued ($T_C = 25^\circ\text{C}$ unless otherwise noted)

Characteristic	Symbol	Min	Typ	Max	Unit
FUNCTIONAL CHARACTERISTICS					
Common-Emitter Amplifier Power Gain ($V_{CC} = 24\text{ Vdc}$, $P_{out} = 30\text{ Watts (PEP)}$, $I_{CQ} = 125\text{ mA}$, $f_1 = 900\text{ MHz}$, $f_2 = 900.1\text{ MHz}$)	G_{pe}	10.5	12.0	—	dB
Collector Efficiency ($V_{CC} = 24\text{ Vdc}$, $P_{out} = 30\text{ Watts (PEP)}$, $I_{CQ} = 125\text{ mA}$, $f_1 = 900\text{ MHz}$, $f_2 = 900.1\text{ MHz}$)	η	30	38	—	%
Intermodulation Distortion ($V_{CC} = 24\text{ Vdc}$, $P_{out} = 30\text{ Watts (PEP)}$, $I_{CQ} = 125\text{ mA}$, $f_1 = 900\text{ MHz}$, $f_2 = 900.1\text{ MHz}$)	IMD	—	-37	-30	dBc
Output Mismatch Stress ($V_{CC} = 26\text{ Vdc}$, $P_{out} = 30\text{ Watts (PEP)}$, $I_{CQ} = 125\text{ mA}$, $f_1 = 900\text{ MHz}$, $f_2 = 900.1\text{ MHz}$, Load VSWR = 5:1 (all phase angles))	ψ	No Degradation in Output Power			

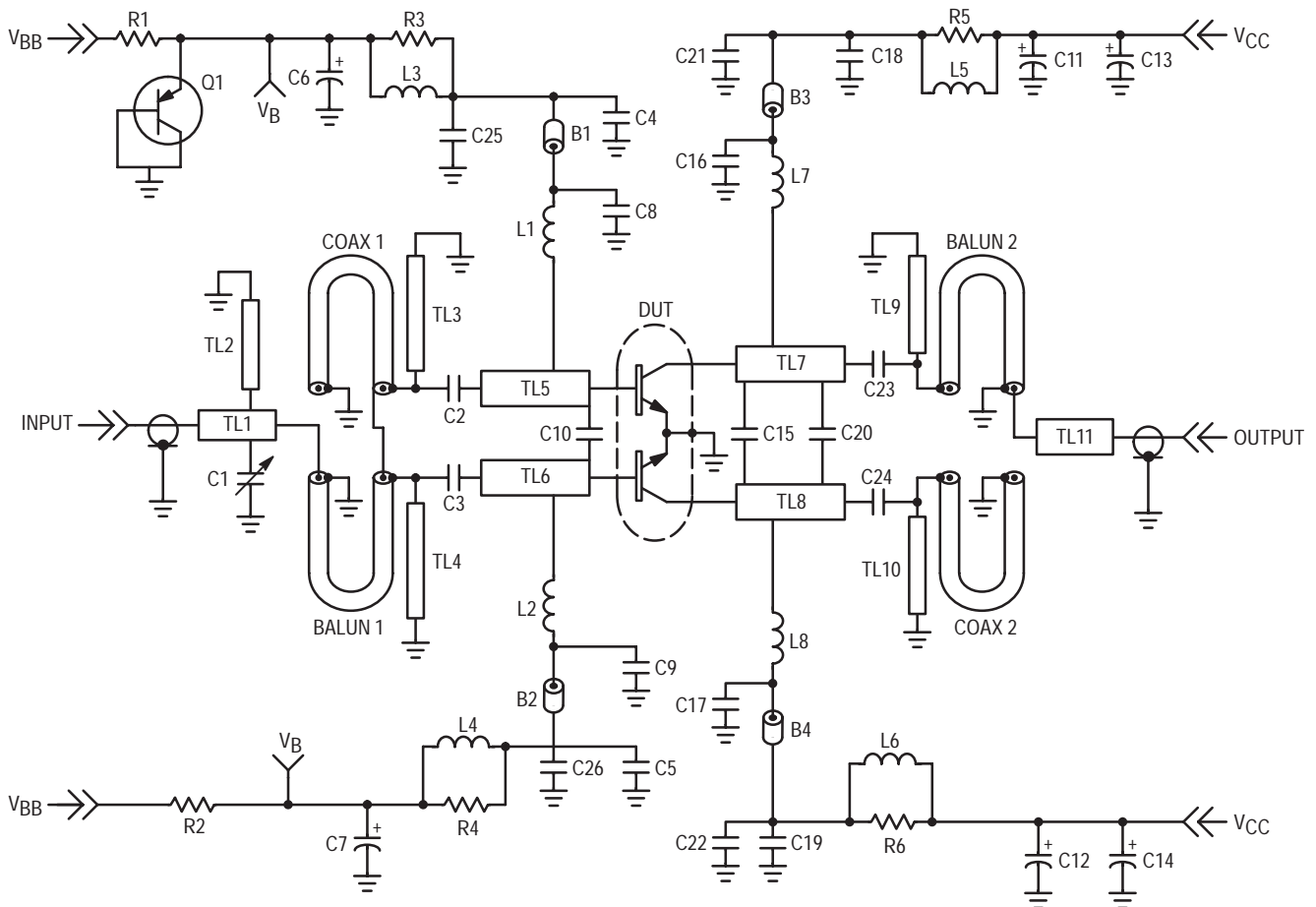

B1, B2, B3, B4 — Short Ferrite Bead, Fair Rite #2743019447
 C1 — 0.8–8.0 pF Var Capacitor, Johansen Gigatrim
 C2, C3, C23, C24 — 43 pF, 100 mil, ATC Chip Capacitor
 C4, C5, C21, C22 — 1000 pF, 100 mil, ATC Chip Capacitor
 C6, C7, C11, C12 — 10 μF , Electrolytic Capacitor, Panasonic
 C8, C9, C16, C17 — 100 pF, 100 mil, ATC Chip Capacitor
 C10 — 9.1 pF, 50 mil, ATC Chip Capacitor
 C13 — 250 μF Electrolytic Capacitor, Mallory
 C14, C18, C19, C25 — 0.1 μF , Chip Capacitor, Kemet
 C15 — 1.1 pF, 50 mil, ATC Chip Capacitor
 C20 — 6.8 pF, 100 mil, ATC Chip Capacitor
 L1, L2, L3, L4, L5, L6, L7, L8 — 5 Turns 20 AWG, IDIA 0.126" Choke, Taylor Spring 46 nH

N1, N2 — Type N Flange Mount, Omni Spectra 3052–1648–10
 Q1 — Bias Transistor BD136 PNP
 R1, R12 — 27 Ohm, 2.0 W
 R3, R4, R5, R6 — 4.0 x 39 Ohm, 1/8 W, Chips Resistors in Parallel, Rohm 390–J
 SB1 — 0.15" x 0.3" x 0.03" Cu
 TL1–TL11 — Microstrip Line, See Photomaster
 Balun1, Balun2, Coax 1, Coax 2 — 2.20" 50 Ohm, 0.086" o.d. semi-rigid coax, Micro Coax UT–85–M17
 Circuit Board — 1/32" Glass Teflon, Arlon GX–0300–55–22, $\epsilon_r = 2.55$

Figure 1. 840–900 MHz Test Circuit Schematic

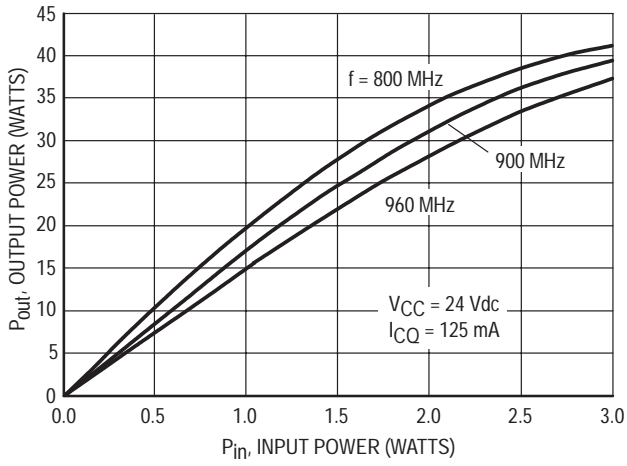

Figure 2. Output Power versus Input Power

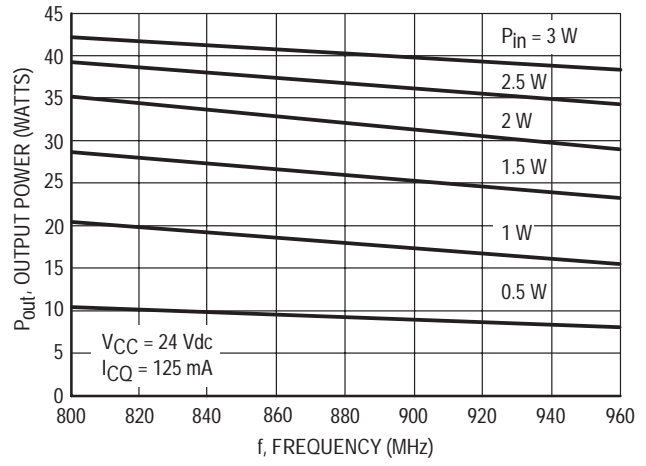

Figure 3. Output Power versus Frequency

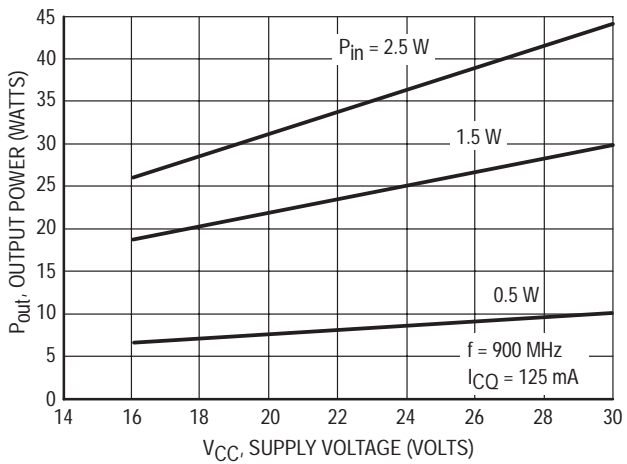

Figure 4. Output Power versus Supply Voltage

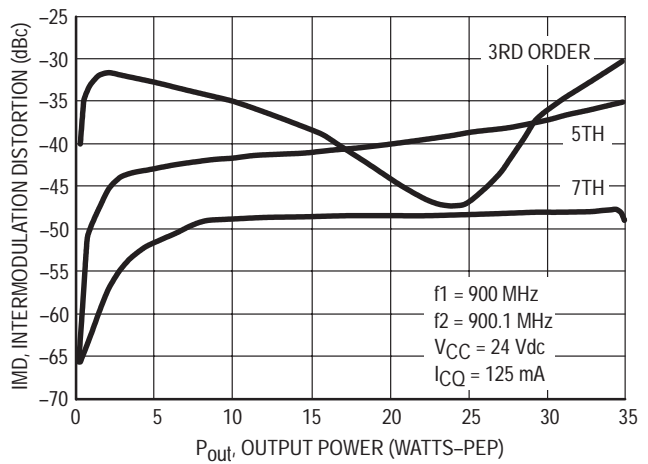

Figure 5. Intermodulation versus Output Power

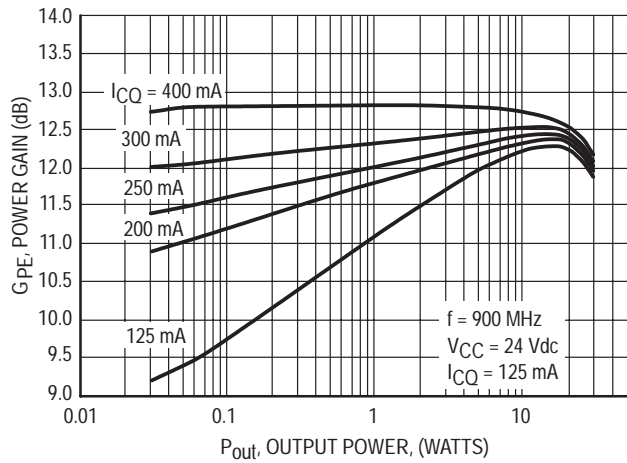

Figure 6. Power Gain versus Output Power

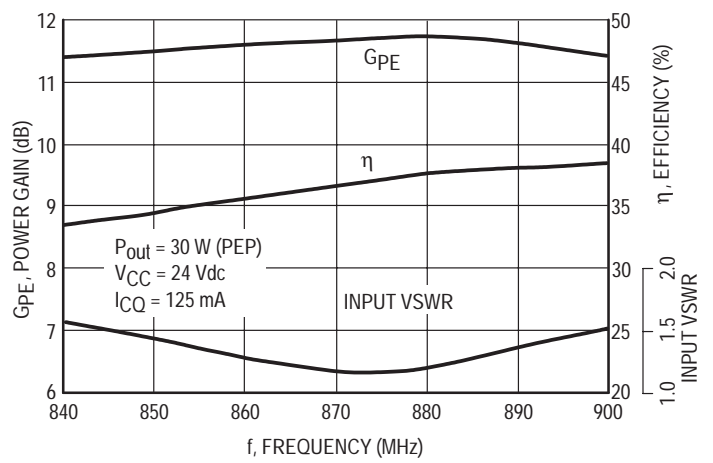
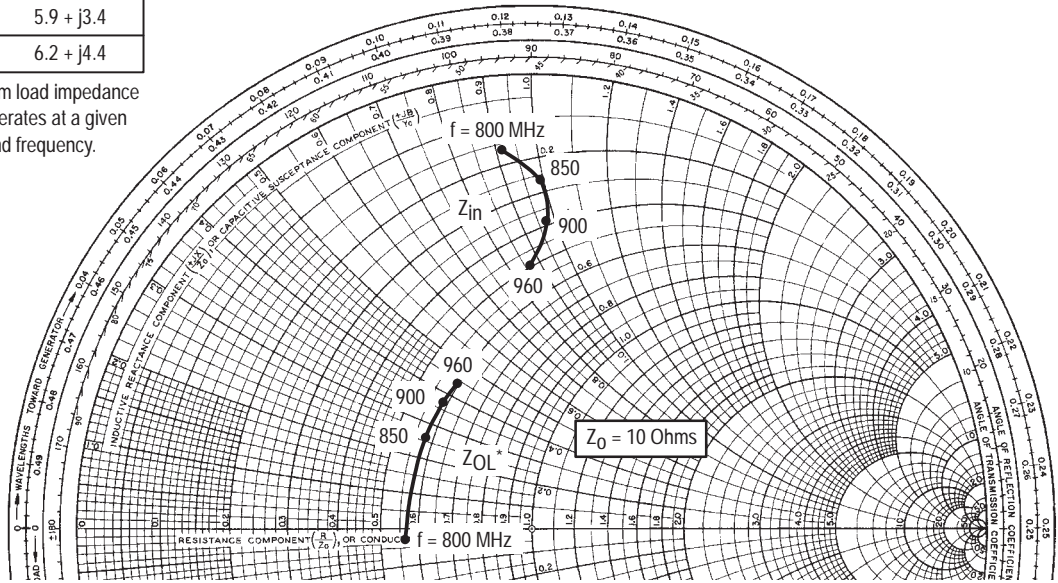

Figure 7. Broadband Test Fixture Performance

$P_{out} = 30 \text{ W (PEP)}, V_{CC} = 24 \text{ V}$

f MHz	Z_{in} Ohms	Z_{OL}^* Ohms
800	$1.7 + j9.2$	$5.9 - j0.4$
850	$2.6 + j10$	$5.7 + j2.6$
900	$4 + j9.9$	$5.9 + j3.4$
950	$5 + j8.8$	$6.2 + j4.4$

Z_{OL}^* = Conjugate of the optimum load impedance into which the device operates at a given output power, voltage and frequency.



NOTE: Z_{in} & Z_{OL}^* are given from base-to-base and collector-to-collector respectively.

Figure 8. Series Equivalent Input/Output Impedances

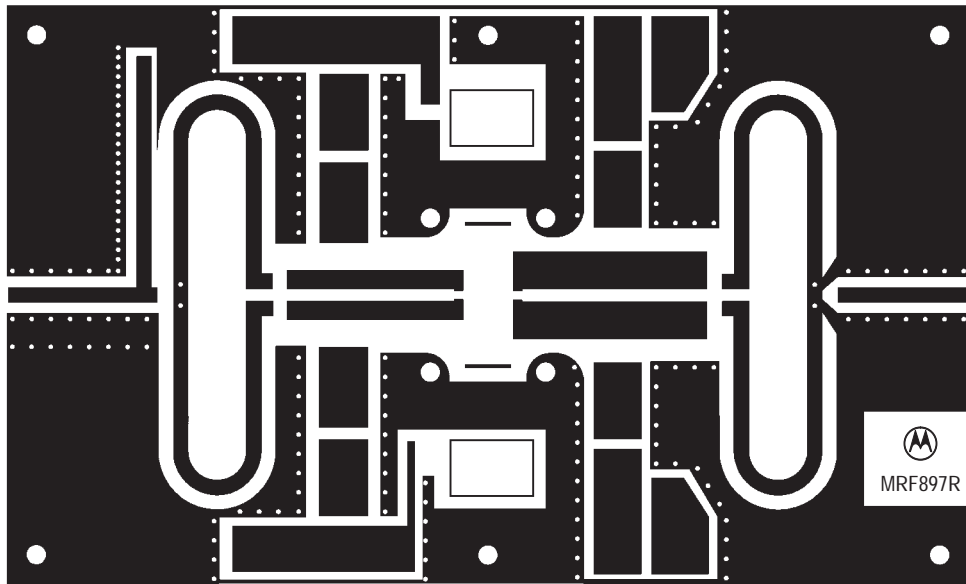

(SCALE: 1:1)

Figure 9. MRF897R Photomaster
(Reduced 25% in printed data book, DL110/D)

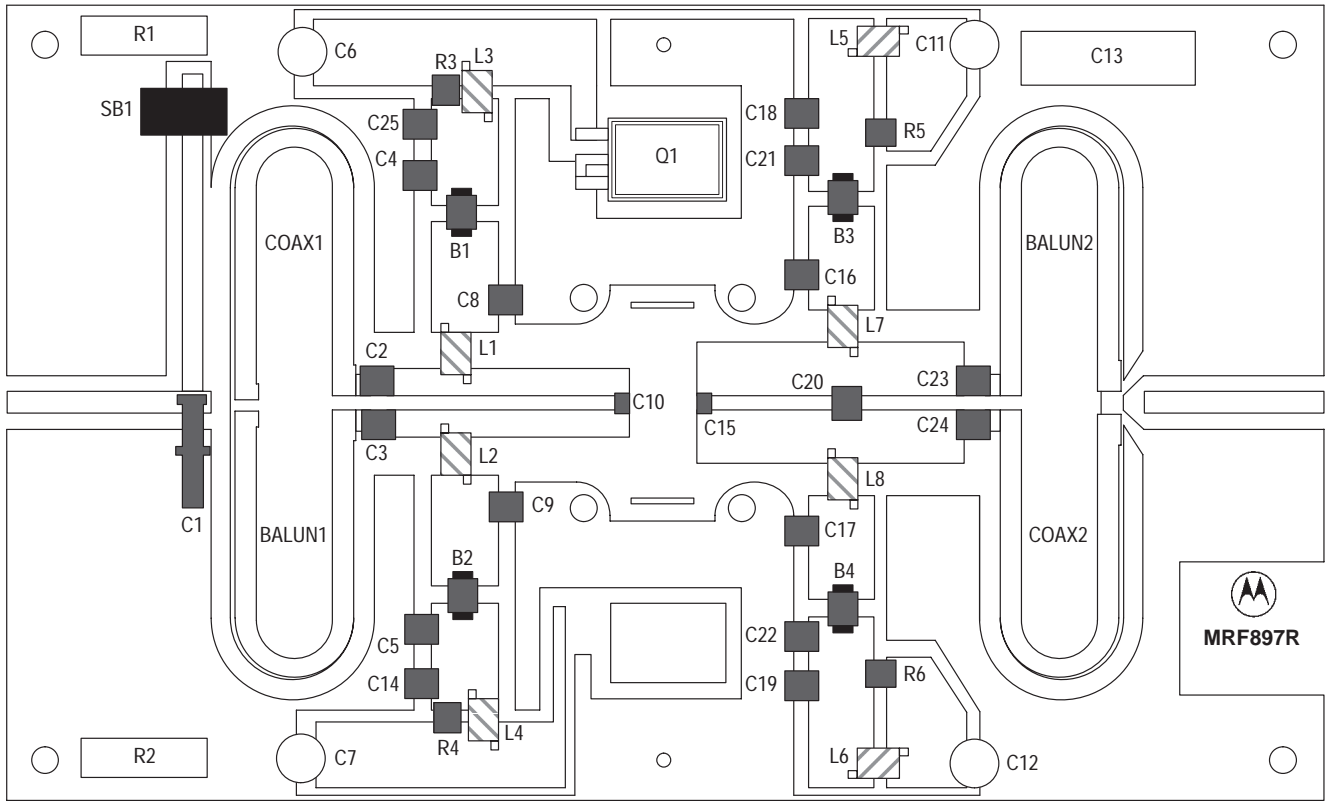
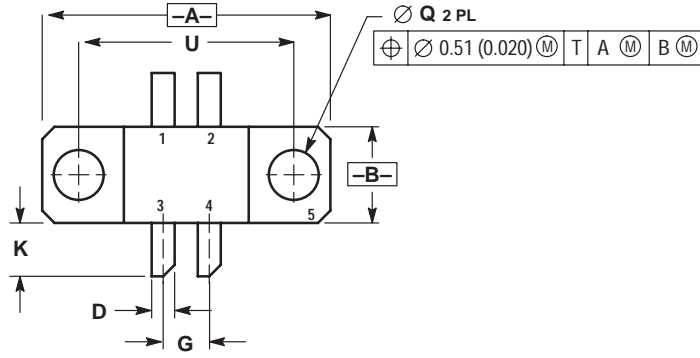

Figure 10. 840–900 MHz Test Circuit Component Layout

PACKAGE DIMENSIONS



- NOTES:
 1. DIMENSIONING AND TOLERANCING PER ANSI Y14.5M, 1982.
 2. CONTROLLING DIMENSION: INCH.

DIM	INCHES		MILLIMETERS	
	MIN	MAX	MIN	MAX
A	0.739	0.750	18.77	19.05
B	0.240	0.260	6.10	6.60
C	0.165	0.198	4.19	5.03
D	0.055	0.065	1.40	1.65
E	0.055	0.070	1.40	1.78
G	0.110	0.130	2.79	3.30
H	0.079	0.091	2.01	2.31
J	0.003	0.005	0.08	0.13
K	0.120	0.150	3.05	3.81
N	0.315	0.330	8.00	8.38
Q	0.125	0.135	3.18	3.42
U	0.560 BSC		14.23 BSC	

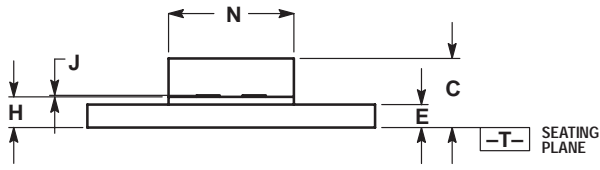

- STYLE 1:
 PIN 1. BASE
 2. BASE
 3. COLLECTOR
 4. COLLECTOR
 5. EMITTER

**CASE 395E-01
 ISSUE O**

NOTES

NOTES

Motorola reserves the right to make changes without further notice to any products herein. Motorola makes no warranty, representation or guarantee regarding the suitability of its products for any particular purpose, nor does Motorola assume any liability arising out of the application or use of any product or circuit, and specifically disclaims any and all liability, including without limitation consequential or incidental damages. "Typical" parameters which may be provided in Motorola data sheets and/or specifications can and do vary in different applications and actual performance may vary over time. All operating parameters, including "Typicals" must be validated for each customer application by customer's technical experts. Motorola does not convey any license under its patent rights nor the rights of others. Motorola products are not designed, intended, or authorized for use as components in systems intended for surgical implant into the body, or other applications intended to support or sustain life, or for any other application in which the failure of the Motorola product could create a situation where personal injury or death may occur. Should Buyer purchase or use Motorola products for any such unintended or unauthorized application, Buyer shall indemnify and hold Motorola and its officers, employees, subsidiaries, affiliates, and distributors harmless against all claims, costs, damages, and expenses, and reasonable attorney fees arising out of, directly or indirectly, any claim of personal injury or death associated with such unintended or unauthorized use, even if such claim alleges that Motorola was negligent regarding the design or manufacture of the part. Motorola and  are registered trademarks of Motorola, Inc. Motorola, Inc. is an Equal Opportunity/Affirmative Action Employer.

Mfax is a trademark of Motorola, Inc.

How to reach us:

USA/EUROPE/Locations Not Listed: Motorola Literature Distribution;
P.O. Box 5405, Denver, Colorado 80217. 1-303-675-2140 or 1-800-441-2447

JAPAN: Motorola Japan Ltd.; SPD, Strategic Planning Office, 141,
4-32-1 Nishi-Gotanda, Shinagawa-ku, Tokyo, Japan. 81-3-5487-8488

Customer Focus Center: 1-800-521-6274

Mfax™: RMFAX0@email.sps.mot.com – TOUCHTONE 1-602-244-6609
Motorola Fax Back System – US & Canada ONLY 1-800-774-1848
– <http://sps.motorola.com/mfax/>

ASIA/PACIFIC: Motorola Semiconductors H.K. Ltd.; Silicon Harbour Centre,
2, Dai King Street, Tai Po Industrial Estate, Tai Po, N.T., Hong Kong.
852-26629298

HOME PAGE: <http://motorola.com/sps/>

