

The RF Line
NPN Silicon
RF Power Transistor

... designed for 12.5 Volt UHF large-signal amplifier applications in industrial and commercial FM equipment operating to 512 MHz.

- Specified 12.5 Volt, 470 MHz Characteristics —
Output Power = 15 Watts
Minimum Gain = 7.8 dB
Efficiency = 55%
- Characterized with Series Equivalent Large-Signal Impedance Parameters
- Built-In Matching Network for Broadband Operation
- Tested for Load Mismatch Stress at all Phase Angles with 20:1 VSWR @ 16-Volt High Line and Overdrive

MRF641

15 W, 470 MHz
CONTROLLED Q
RF POWER
TRANSISTOR
NPN SILICON

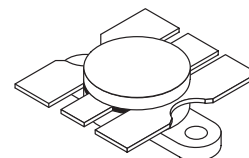

CASE 316-01, STYLE 1

MAXIMUM RATINGS

Rating	Symbol	Value	Unit
Collector-Emitter Voltage	V_{CEO}	16	Vdc
Collector-Base Voltage	V_{CBO}	36	Vdc
Emitter-Base Voltage	V_{EBO}	4.0	Vdc
Collector Current — Continuous	I_C	3.0	Adc
Total Device Dissipation @ $T_C = 25^\circ\text{C}$ Derate above 25°C	P_D	43.7 0.25	Watts W/ $^\circ\text{C}$
Storage Temperature Range	T_{stg}	-65 to +150	$^\circ\text{C}$

THERMAL CHARACTERISTICS

Characteristic	Symbol	Max	Unit
Thermal Resistance, Junction to Case	$R_{\theta JC}$	4.0	$^\circ\text{C/W}$

ELECTRICAL CHARACTERISTICS ($T_C = 25^\circ\text{C}$ unless otherwise noted.)

Characteristic	Symbol	Min	Typ	Max	Unit
----------------	--------	-----	-----	-----	------

OFF CHARACTERISTICS

Collector-Emitter Breakdown Voltage ($I_C = 20\text{ mAdc}$, $I_B = 0$)	$V_{(BR)CEO}$	16	—	—	Vdc
Collector-Emitter Breakdown Voltage ($I_C = 20\text{ mAdc}$, $V_{BE} = 0$)	$V_{(BR)CES}$	36	—	—	Vdc
Emitter-Base Breakdown Voltage ($I_E = 5.0\text{ mAdc}$, $I_C = 0$)	$V_{(BR)EBO}$	4.0	—	—	Vdc
Collector Cutoff Current ($V_{CE} = 15\text{ Vdc}$, $V_{BE} = 0$, $T_C = 25^\circ\text{C}$)	I_{CES}	—	—	5.0	mAdc

(continued)

LIFETIME BUY

LAST SHIP 06/07/00
LAST ORDER 06/01/00

ELECTRICAL CHARACTERISTICS — continued ($T_C = 25^\circ\text{C}$ unless otherwise noted.)

Characteristic	Symbol	Min	Typ	Max	Unit
ON CHARACTERISTICS					
DC Current Gain ($I_C = 1.0 \text{ Adc}$, $V_{CE} = 5.0 \text{ Vdc}$)	h_{FE}	30	70	150	—
DYNAMIC CHARACTERISTICS					
Output Capacitance ($V_{CB} = 12.5 \text{ Vdc}$, $I_E = 0$, $f = 1.0 \text{ MHz}$)	C_{ob}	—	40	60	pF
FUNCTIONAL TESTS					
Common-Emitter Amplifier Power Gain ($V_{CC} = 12.5 \text{ Vdc}$, $P_{out} = 15 \text{ W}$, $f = 470 \text{ MHz}$)	G_{pe}	7.8	8.5	—	dB
Collector Efficiency ($V_{CC} = 12.5 \text{ Vdc}$, $P_{out} = 15 \text{ W}$, $f = 470 \text{ MHz}$)	η	55	60	—	%
Output Mismatch Stress ($V_{CC} = 16 \text{ Vdc}$, $P_{in} = 3.0 \text{ W}$, $f = 470 \text{ MHz}$, $V_{SWR} = 20:1$, All Phase Angles)	ψ	No Degradation in Output Power			

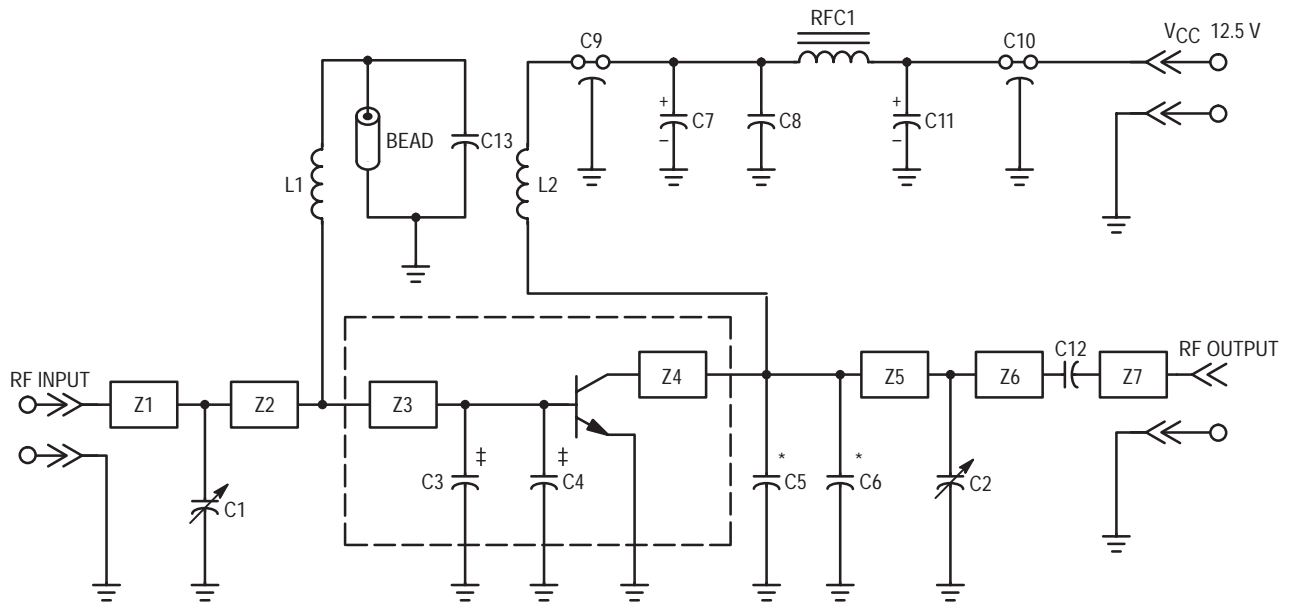

PARTS

- Z1 — 1.225" x 0.187" Microstrip
- Z2 — 0.884" x 0.187" Microstrip
- Z3 — Capacitor Block (Base)
- Z4 — Collector Block
- Z5 — 1.1" x 0.187" Microstrip
- Z6 — 0.433" x 0.187" Microstrip
- Z7 — 0.4" x 0.187" Microstrip
- Dotted Area — Capacitor Assembly

- C1, C2 — 0.8–10 pF Johanson
- C3, C4 — 24 pF Chip Caps 100 mils ATC
- C5, C6 — 22 pF Chip Caps 100 mils ATC
- C12 — 220 pF Chip Cap 100 mils ATC
- C7, C11 — 1.0 μF Tantalum 35 Vdc
- C9, C10 — 680 pF Feedthrough Allen-Bradley
- C13 — 200 pF UNELCO
- C8 — 0.1 μF , 50 V Erie Red Cap
- RFC1 — VK 200 — 104B Ferrite Choke
- L1 — 4 Turns 0.2" Dia. #16 AWG
- L2 — 9 Turns 0.15" Dia. #16 AWG

Bead — Ferroxcube 56-590-65-35EB

NOTES

- *C5, C6, are mounted as close to the capacitor assembly as possible.
- ‡‡C3, C4 are mounted in the capacitor assembly.
- Board — 62.5 mil Glass Teflon, $\epsilon_r = 2.55$.

Figure 1. Test Circuit Schematic

LIFETIME BUY

LAST SHIP 06/07/00 LAST ORDER 06/01/00

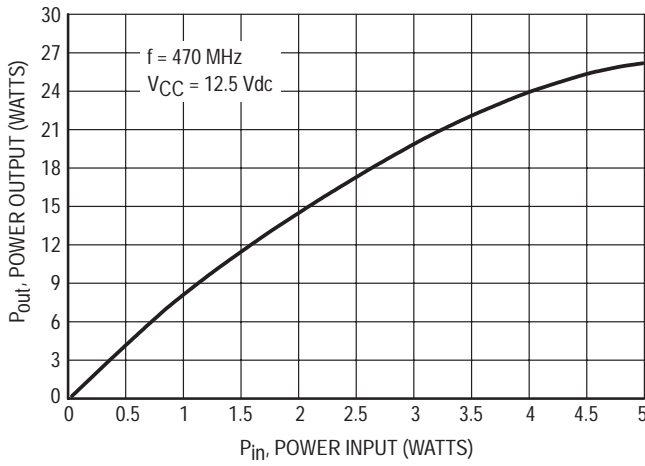

Figure 2. Power Output versus Power Input

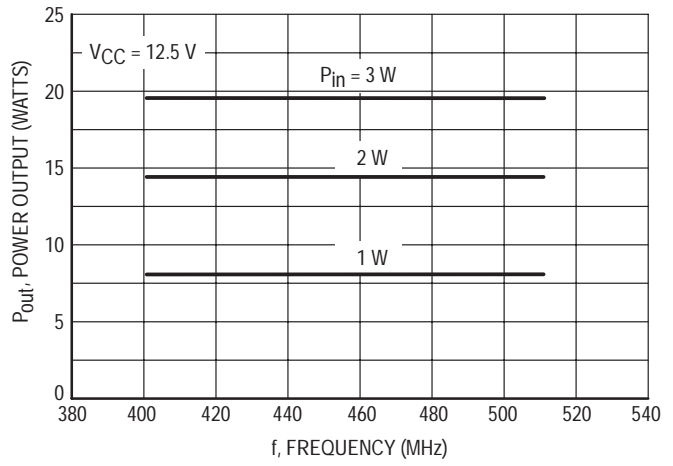

Figure 3. Power Output versus Frequency

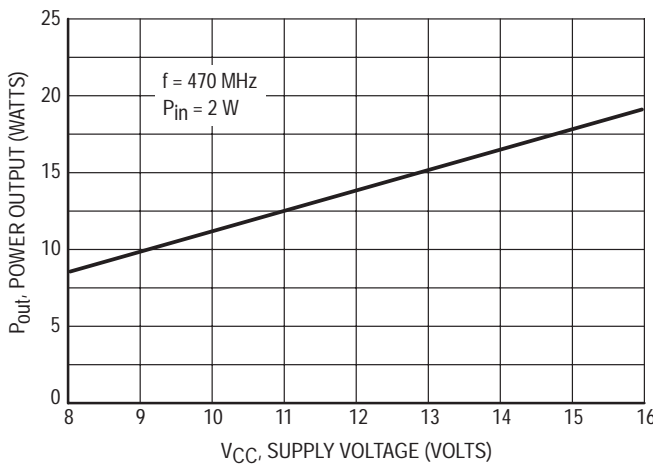

Figure 4. Power Output versus Supply Voltage

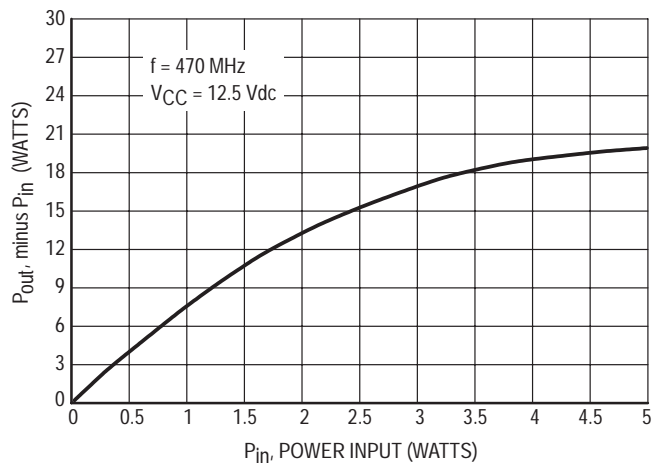
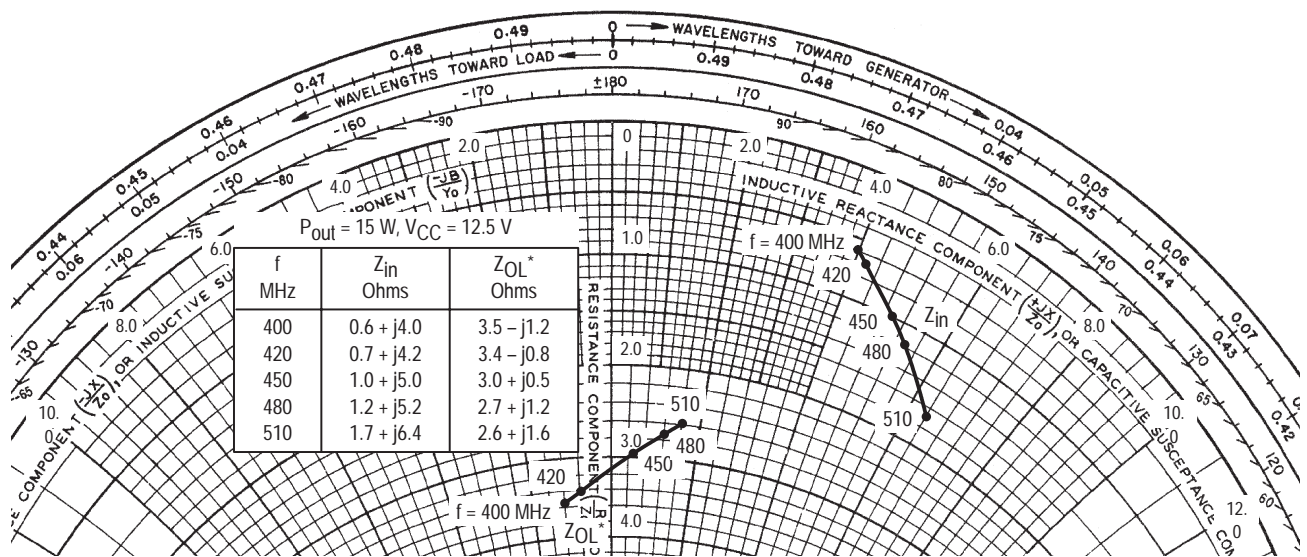

Figure 5. Power Saturation Profile



Z_{OL}^{*} = Conjugate of the load impedance into which the device output operates at a given power, η, and frequency.

Figure 6. Series Equivalent Input-Output Impedance

PACKAGE DIMENSIONS

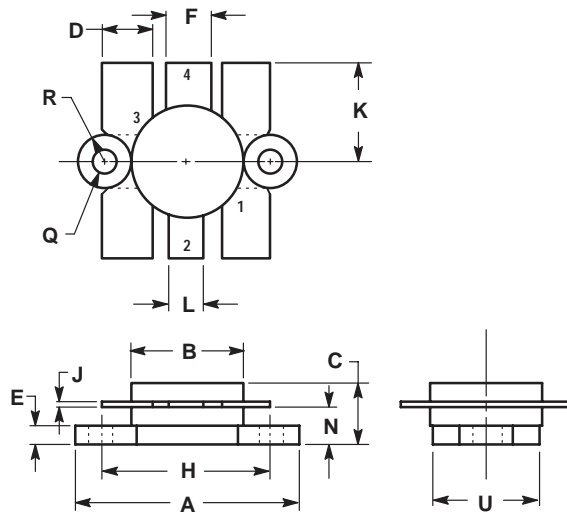

NOTES:
1. FLANGE IS ISOLATED IN ALL STYLES.

DIM	INCHES		MILLIMETERS	
	MIN	MAX	MIN	MAX
A	24.38	25.14	0.960	0.990
B	12.45	12.95	0.490	0.510
C	5.97	7.62	0.235	0.300
D	5.33	5.58	0.210	0.220
E	2.16	3.04	0.085	0.120
F	5.08	5.33	0.200	0.210
H	18.29	18.54	0.720	0.730
J	0.10	0.15	0.004	0.006
K	10.29	11.17	0.405	0.440
L	3.81	4.06	0.150	0.160
N	3.81	4.31	0.150	0.170
Q	2.92	3.30	0.115	0.130
R	3.05	3.30	0.120	0.130
U	11.94	12.57	0.470	0.495

STYLE 1:
PIN 1. EMITTER
2. COLLECTOR
3. EMITTER
4. BASE

CASE 316-01
ISSUE D

LIFETIME BUY

LAST SHIP 06/07/00

LAST ORDER 06/01/00

Motorola reserves the right to make changes without further notice to any products herein. Motorola makes no warranty, representation or guarantee regarding the suitability of its products for any particular purpose, nor does Motorola assume any liability arising out of the application or use of any product or circuit, and specifically disclaims any and all liability, including without limitation consequential or incidental damages. "Typical" parameters which may be provided in Motorola data sheets and/or specifications can and do vary in different applications and actual performance may vary over time. All operating parameters, including "Typicals" must be validated for each customer application by customer's technical experts. Motorola does not convey any license under its patent rights nor the rights of others. Motorola products are not designed, intended, or authorized for use as components in systems intended for surgical implant into the body, or other applications intended to support or sustain life, or for any other application in which the failure of the Motorola product could create a situation where personal injury or death may occur. Should Buyer purchase or use Motorola products for any such unintended or unauthorized application, Buyer shall indemnify and hold Motorola and its officers, employees, subsidiaries, affiliates, and distributors harmless against all claims, costs, damages, and expenses, and reasonable attorney fees arising out of, directly or indirectly, any claim of personal injury or death associated with such unintended or unauthorized use, even if such claim alleges that Motorola was negligent regarding the design or manufacture of the part. Motorola and are registered trademarks of Motorola, Inc. Motorola, Inc. is an Equal Opportunity/Affirmative Action Employer.

Mfax is a trademark of Motorola, Inc.

How to reach us:

USA/EUROPE/Locations Not Listed: Motorola Literature Distribution;
P.O. Box 5405, Denver, Colorado 80217. 303-675-2140 or 1-800-441-2447

JAPAN: Nippon Motorola Ltd.: SPD, Strategic Planning Office, 4-32-1,
Nishi-Gotanda, Shinagawa-ku, Tokyo 141, Japan. 81-3-5487-8488

Mfax™: RMFAX0@email.sps.mot.com – TOUCHTONE 602-244-6609
– US & Canada ONLY 1-800-774-1848

ASIA/PACIFIC: Motorola Semiconductors H.K. Ltd.; 8B Tai Ping Industrial Park,
51 Ting Kok Road, Tai Po, N.T., Hong Kong. 852-26629298

INTERNET: <http://motorola.com/sps>

