

Product Is Not Recommended for New Design.
The next generation of higher performance products are in development. Visit our online Selector Guides (<http://mot-sps.com/rf/sg/sg.html>) for scheduled introduction dates.

MRF373
MRF373S

60 W, 470 – 860 MHz, 28 V
LATERAL N-CHANNEL
BROADBAND
RF POWER MOSFETS

The RF MOSFET Line
RF Power
Field Effect Transistors
N-Channel Enhancement-Mode Lateral MOSFETs

Designed for broadband commercial and industrial applications at frequencies from 470 – 860 MHz. The high gain and broadband performance of this device makes it ideal for large-signal, common source amplifier applications in 28 volt transmitter equipment.

- Guaranteed CW Performance at 860 MHz, 28 Volts, Narrowband Fixture
Output Power – 60 Watts
Power Gain – 13 dB
Efficiency – 50%
- Typical Performance at 860 MHz, 28 Volts, Broadband Push-Pull Fixture
Output Power – 100 Watts (PEP)
Power Gain – 11.2 dB
Efficiency – 40%
IMD – -30 dBc
- Excellent Thermal Stability
- 100% Tested for Load Mismatch Stress at All Phase Angles with 5:1 VSWR @ 28 Vdc, 860 MHz, 60 Watts CW

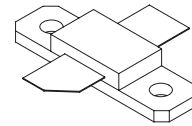
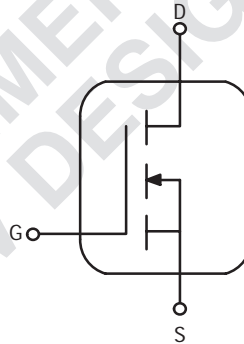

CASE 360B-03, STYLE 1
(MRF373)

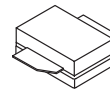

CASE 360C-03, STYLE 1
(MRF373S)

MAXIMUM RATINGS

Rating	Symbol	Value	Unit
Drain-Source Voltage	V_{DSS}	65	Vdc
Gate-Source Voltage	V_{GS}	± 20	Vdc
Drain Current – Continuous	I_D	7	Adc
Total Device Dissipation @ $T_C = 25^\circ\text{C}$ Derate above 25°C	MRF373S P_D	173 1.33	W W/ $^\circ\text{C}$
Storage Temperature Range	T_{stg}	- 65 to +150	$^\circ\text{C}$
Operating Junction Temperature	T_J	200	$^\circ\text{C}$

THERMAL CHARACTERISTICS

Characteristic	Symbol	Max	Unit
Thermal Resistance, Junction to Case	MRF373S $R_{\theta JC}$	0.75	$^\circ\text{C}/\text{W}$
Thermal Resistance, Junction to Case	MRF373 $R_{\theta JC}$	1	$^\circ\text{C}/\text{W}$

NOTE – **CAUTION** – MOS devices are susceptible to damage from electrostatic charge. Reasonable precautions in handling and packaging MOS devices should be observed.

ELECTRICAL CHARACTERISTICS ($T_C = 25^\circ\text{C}$ unless otherwise noted)

Characteristic	Symbol	Min	Typ	Max	Unit
----------------	--------	-----	-----	-----	------

OFF CHARACTERISTICS

Drain–Source Breakdown Voltage ($V_{GS} = 0, I_D = 1 \mu\text{A}$)	$V_{(BR)DSS}$	65	–	–	Vdc
Zero Gate Voltage Drain Current ($V_{DS} = 28 \text{ V}, V_{GS} = 0$)	I_{DSS}	–	–	1	μA_{dc}
Gate–Source Leakage Current ($V_{GS} = 20 \text{ V}, V_{DS} = 0$)	I_{GSS}	–	–	1	μA_{dc}

ON CHARACTERISTICS

Gate Threshold Voltage ($V_{DS} = 10 \text{ V}, I_D = 200 \mu\text{A}$)	$V_{GS(th)}$	2	3	4	Vdc
Gate Quiescent Voltage ($V_{DS} = 28 \text{ V}, I_D = 100 \text{ mA}$)	$V_{GS(Q)}$	3	4	5	Vdc
Drain–Source On–Voltage ($V_{GS} = 10 \text{ V}, I_D = 3 \text{ A}$)	$V_{DS(on)}$	–	0.6	0.8	Vdc
Forward Transconductance ($V_{DS} = 10 \text{ V}, I_D = 3 \text{ A}$)	g_{fs}	2.2	2.9	–	S

DYNAMIC CHARACTERISTICS

Input Capacitance ($V_{DS} = 28 \text{ V}, V_{GS} = 0, f = 1 \text{ MHz}$)	C_{iss}	–	79	–	pF
Output Capacitance ($V_{DS} = 28 \text{ V}, V_{GS} = 0, f = 1 \text{ MHz}$)	C_{oss}	–	46	–	pF
Reverse Transfer Capacitance ($V_{DS} = 28 \text{ V}, V_{GS} = 0, f = 1 \text{ MHz}$)	C_{rss}	–	4	–	pF

FUNCTIONAL CHARACTERISTICS, CW Operation

Common Source Power Gain ($V_{DD} = 28 \text{ V}, P_{out} = 60 \text{ W}, I_{DQ} = 200 \text{ mA}, f = 860 \text{ MHz}$)	G_{ps}	13	14.7	–	dB
Drain Efficiency ($V_{DD} = 28 \text{ V}, P_{out} = 60 \text{ W}, I_{DQ} = 200 \text{ mA}, f = 860 \text{ MHz}$)	η	50	54	–	%
Load Mismatch ($V_{DD} = 28 \text{ V}, P_{out} = 60 \text{ W}, I_{DQ} = 200 \text{ mA}, f = 860 \text{ MHz}$, Load VSWR at 5:1 at All Phase Angles)	ψ	No Degradation in Output Power			

TYPICAL CHARACTERISTICS, 2 Tone Operation, Push Pull Configuration (MRF373S), Broadband Fixture

Common Source Power Gain ($V_{DD} = 28 \text{ Vdc}, P_{out} = 100 \text{ W PEP}, I_{DQ} = 400 \text{ mA}$, $f_1 = 860.0 \text{ MHz}, f_2 = 866 \text{ MHz}$)	G_{ps}	–	11.2	–	dB
Drain Efficiency ($V_{DD} = 28 \text{ Vdc}, P_{out} = 100 \text{ W PEP}, I_{DQ} = 400 \text{ mA}$, $f_1 = 860.0 \text{ MHz}, f_2 = 866 \text{ MHz}$)	η	–	40	–	%
Third Order Intermodulation Distortion ($V_{DD} = 28 \text{ Vdc}, P_{out} = 100 \text{ W PEP}, I_{DQ} = 400 \text{ mA}$, $f_1 = 860.0 \text{ MHz}, f_2 = 866 \text{ MHz}$)	IMD	–	–30	–	dBc

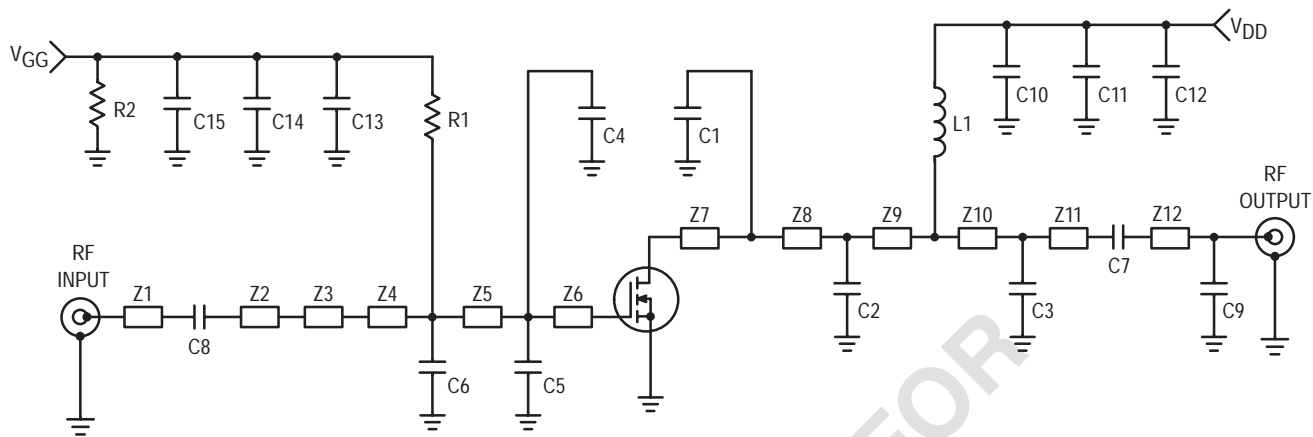

C1	4.7 pF, B Case Chip Capacitor, ATC	Connectors	N-Type (female), M/A Com P/N 3052-1648-10
C2	15 pF, B Case Chip Capacitor, ATC	PCB	MRF373 Printed Circuit Board Rev 01, CuClad 250 (GX-0300-55), height 30 mils, $\epsilon_r = 2.55$
C3	6.8 pF, B Case Chip Capacitor, ATC	Heatsink	Motorola P/N 95-11LDMOSKPS-1
C4, C5, C6	10 pF, B Case Chip Capacitor, ATC		LDMOS μ 250 3" x 5" Bedstead
C7, C8	47 pF, B Case Chip Capacitor, ATC	Insert	Motorola P/N 95-11LDMOSKPS-2
C9	0.2 pF, B Case Chip Capacitor, ATC		Insert for LDMOS μ 250 3" x 5" Bedstead
C10, C13	300 pF, B Case Chip Capacitor, ATC, Side Mounted	End Plates	2) Motorola P/N 93-3MB-9, End Plate for Type-N Connector
C11	2) 2.2 μ F, 50 V, Kemet P/N C1825C225	Banana Jack and Nut	
C12	22 μ F, 50 V, Kemet P/N T491D226K50AS		2) Johnson P/N 108-0904-001
C14	2) 1.0 μ F, 50 V, Kemet P/N C1825C105	Brass Banana Jack	
C15	10 μ F, 35 V, Kemet P/N T491D106K35AS		2) H.H. Smith P/N SM-101
L1	22 nH, Coilcraft P/N B07T		
R1	1.2 k Ω , Vishay Dale Chip Resistor (1206)		
R2	12 k Ω , Vishay Dale Chip Resistor (1206)		

Figure 1. Single-Ended Narrowband Test Circuit Schematic (MRF373)

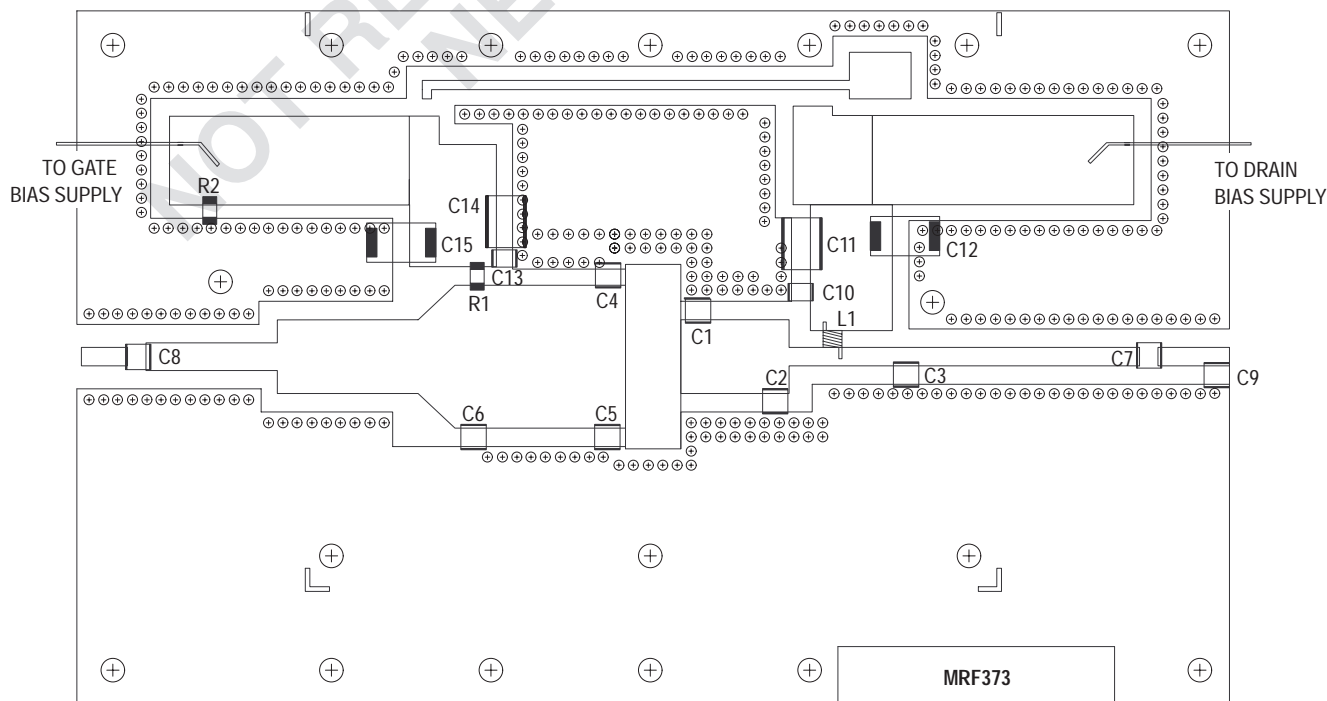

Figure 2. Single-Ended Narrowband Test Circuit Layout (Suitable for Use with MRF373)

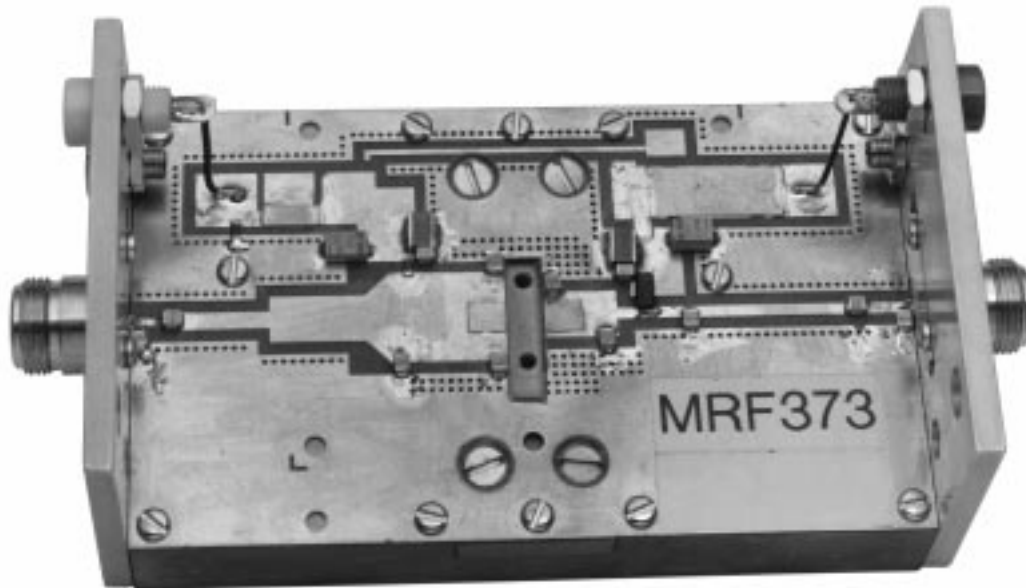
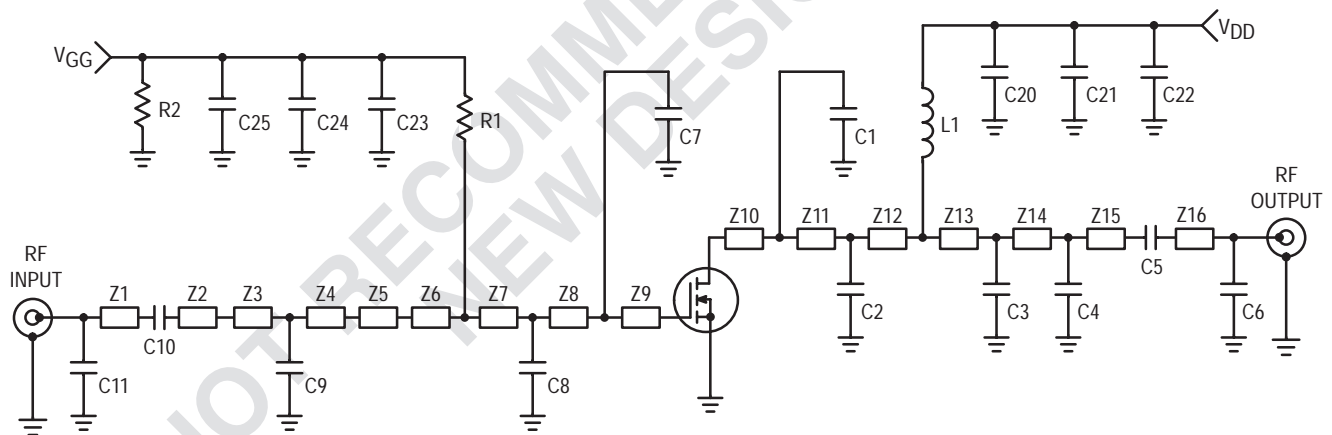

Figure 3. MRF373 Narrowband Test Fixture Photo



C1, C2	18 pF, B Case Chip Capacitor, ATC
C3	12 pF, B Case Chip Capacitor, ATC
C4, C11	0.8 pF, B Case Chip Capacitor, ATC
C5, C10	68 pF, B Case Chip Capacitor, ATC
C6	0.3 pF, B Case Chip Capacitor, ATC
C7	15 pF, B Case Chip Capacitor, ATC
C8	10 pF, B Case Chip Capacitor, ATC
C9	1.8 pF, B Case Chip Capacitor, ATC
C20, C23	300 pF, B Case Chip Capacitor, ATC, Side Mounted
C21	2) 2.2 μ F, 100 V, Vishay P/N VJ3640Y225KXBAT
C24	2) 1.0 μ F, 50 V, Kemet P/N C1825C105
C22	22 μ F, 35 V, Kemet P/N T491D226K35AS
C25	10 μ F, 35 V, Kemet P/N T491D106K35AS
L1	22 nH, Coilcraft P/N B07T
R1	1.2 k Ω , Vishay Dale Chip Resistor (1206)
R2	12 k Ω , Vishay Dale Chip Resistor (1206)

Connectors	N-Type (female), M/A Com P/N 3052-1648-10
PCB	MRF373 Printed Circuit Board Rev 01, CuClad 250 (GX-0300-55), height 30 mils, $\epsilon_r = 2.55$ (new PCB's available from CMR)
Heatsink	Motorola P/N 95-11LDMOSKPS-1 LDMOS μ 250 3" x 5" Bedstead
Insert	Motorola P/N 95-11LDMOSKPS-2S Insert for LDMOS μ 250S 3" x 5" Bedstead
End Plates	2) Motorola P/N 93-3MB-9, End Plate for Type-N Connector
Banana Jack and Nut	2) Johnson P/N 108-0904-001
Brass Banana Jack	2) H.H. Smith P/N SM-101

Figure 4. Single-Ended Narrowband Test Circuit Schematic (MRF373S)

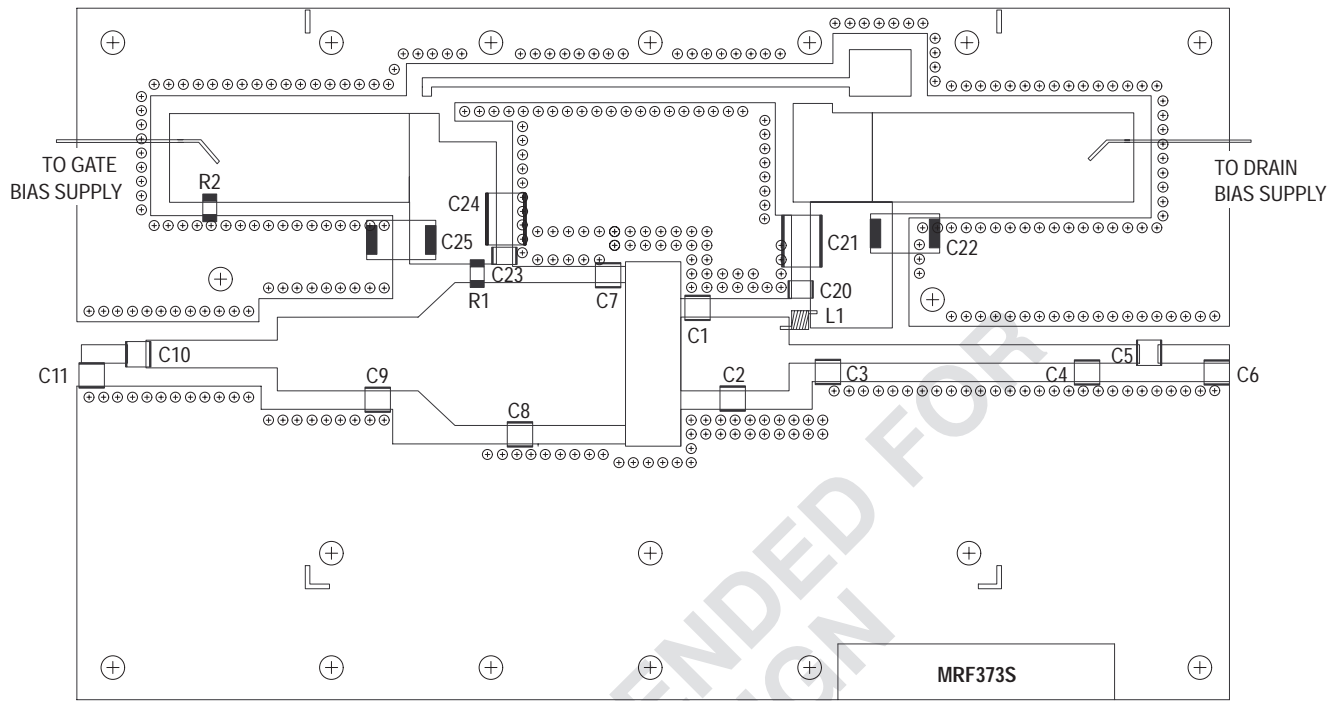

Figure 5. Single-Ended Narrowband Test Circuit Layout
(Suitable for Use with MRF373S)

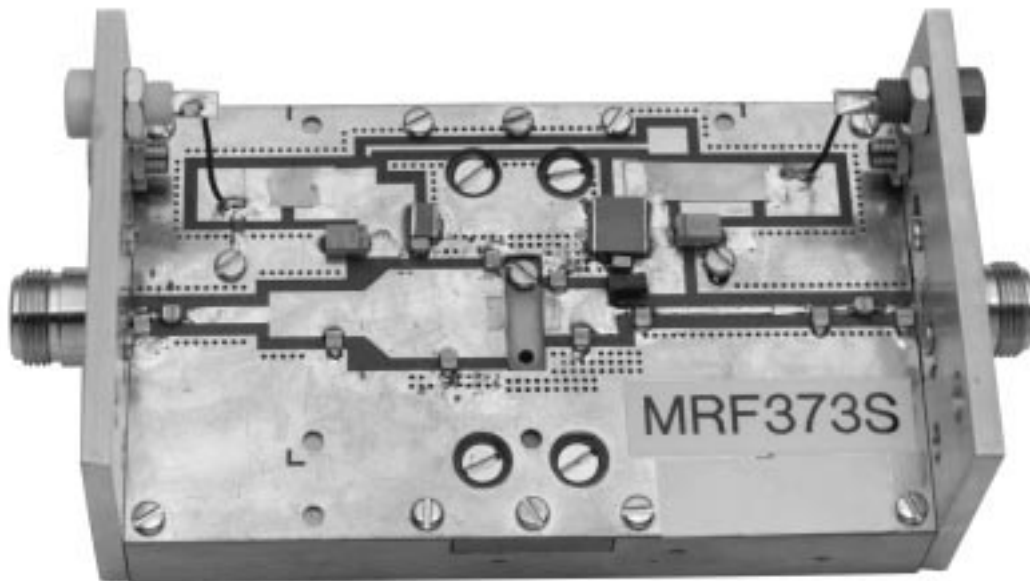

Figure 6. MRF373S Narrowband Test Circuit Photo

TYPICAL CHARACTERISTICS FOR MRF373 IN SINGLE-ENDED FIXTURE

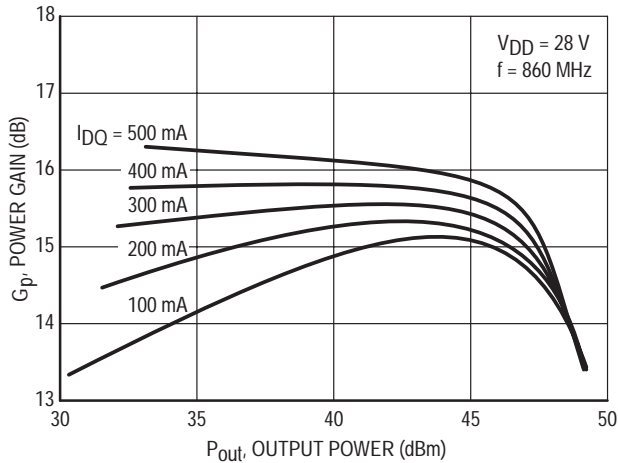

Figure 7. Power Gain versus Output Power

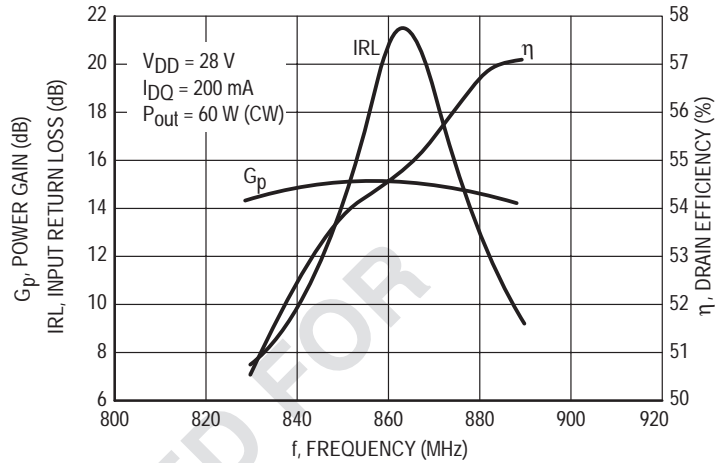

Figure 8. Performance in Narrowband Circuit

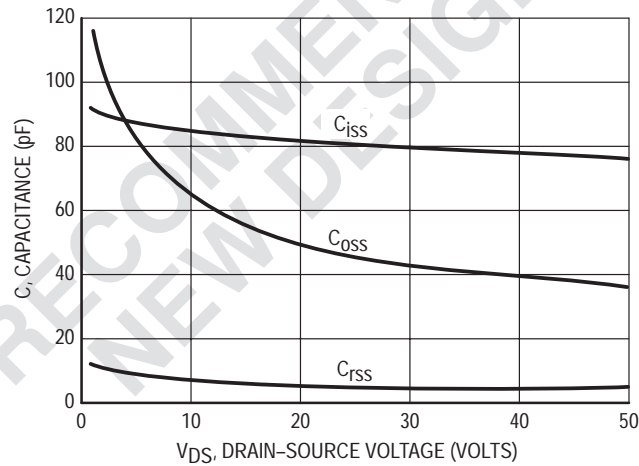
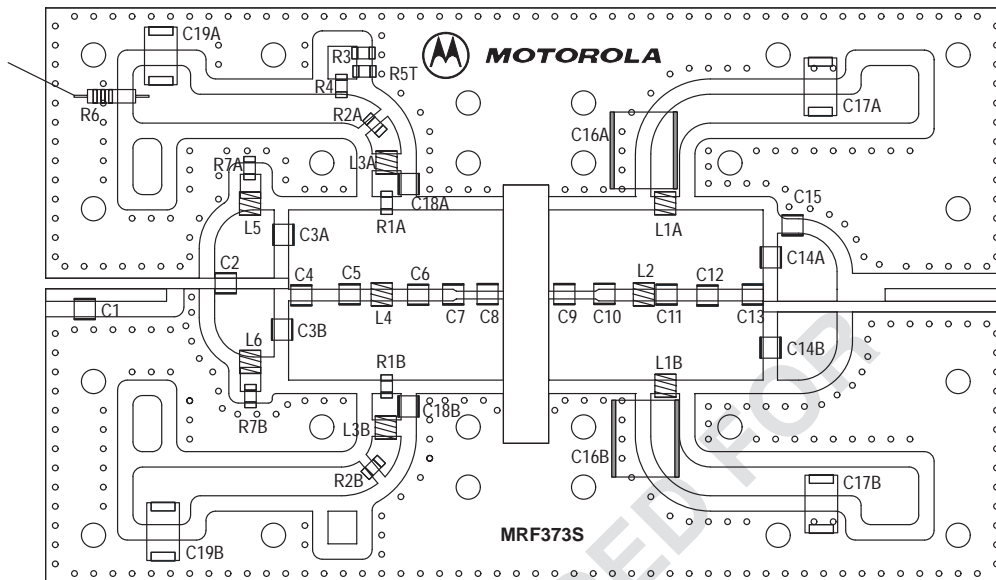

Figure 9. Capacitance versus Voltage

Table 1. Common Source S-Parameters ($V_{DS} = 28\text{ V}$, $I_D = 2.0\text{ A}$)

f MHz	S11		S21		S12		S22	
	S11	ϕ	S21	ϕ	S12	ϕ	S22	ϕ
400	0.921	182	2.23	52	0.009	39	0.824	184
450	0.922	181	1.95	49	0.009	53	0.832	184
500	0.924	180	1.70	46	0.010	64	0.841	184
550	0.926	179	1.49	42	0.011	72	0.851	183
600	0.929	178	1.31	38	0.013	78	0.860	183
650	0.932	177	1.16	35	0.015	81	0.870	182
700	0.936	176	1.03	31	0.017	82	0.881	182
750	0.940	176	0.93	28	0.019	82	0.892	181
800	0.945	175	0.84	26	0.021	82	0.904	180
850	0.951	174	0.78	24	0.023	80	0.917	180
900	0.957	173	0.72	24	0.025	78	0.929	179



Vertical Balun Mounting Detail

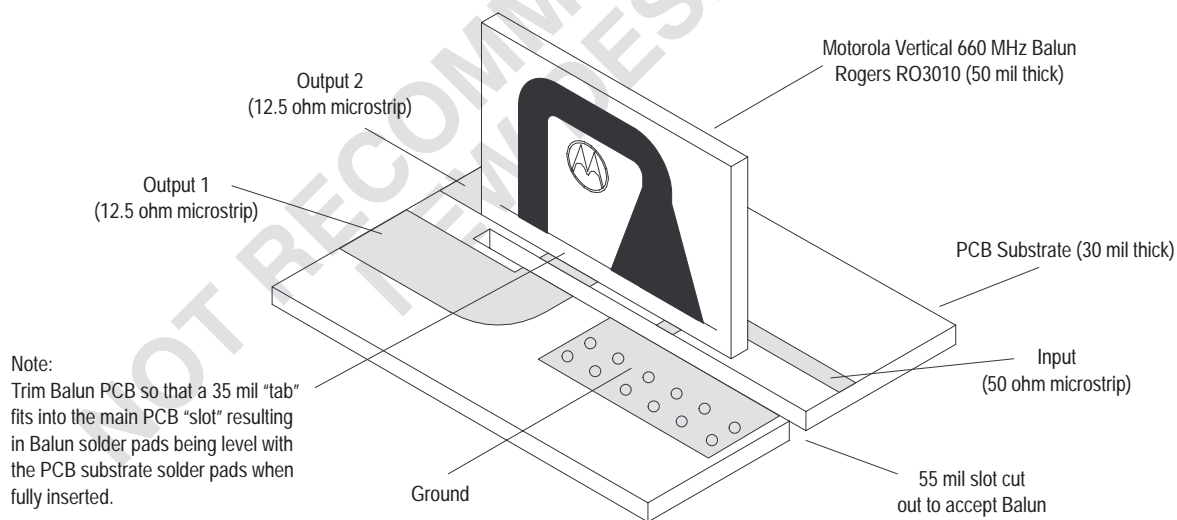

Figure 10. MRF373S Broadband Push-Pull Component Layout

Table 2. MRF373S Broadband Push–Pull Application Parts List

Designation	Description
C1	1.0 pF, AVX, P12101J1R0BBT
C2, C4, C10	10 pF, AVX, P12101J100GBT
C3A, B	120 pF, 300 V, AVX, AQ149M121JAJBE
C5, C6, C9	12 pF, AVX, P12101J120GBT
C7, C8	18 pF, AVX, P12101J180GBT
C11	6.8 pF, AVX, P12101J6R8BBT
C12	4.7 pF, AVX, P12101J4R7BBT
C13, C18A, B	3.3 pF, AVX, P12101J3R3BBT
C14A, B	100 pF, 500 V, AVX, AQ147M101JAJBE
C15	2.7 pF, AVX, P12101J2R7BBT
C16A, B	3.3 μ F, 100 V, Vitramon P/N VJ3640Y335KXBAT
C17A, B, C19A, B	22 μ F, 35 V, Kemet P/N T491D226K35AS
L1A, B, L3A, B, L4, L5	8.0 nH, Coilcraft P/N A03T
L2, L6	12.5 nH, Coilcraft P/N A04T
R1A, B	22 Ω , Vishay Dale Chip Resistor, 1/4 W (1206)
R2A, B	10 Ω , Vishay Dale Chip Resistor, 1/4 W (1206)
R3	390 Ω , Vishay Dale Chip Resistor (1206)
R4	2.4 k Ω , Vishay Dale Chip Resistor (1206)
R5T	470 Ω Thermistor, KOA SPEER MOT P/N 0680149M01
PCB	MRF373 PP Printed Circuit Board Rev 2C, Rogers RO4350, Height 30 mils, $\epsilon_r = 3.48$
Balun A, B	Vertical 660 MHz Broadband Balun, Printed Circuit Board Rev 01, Rogers RO3010, Height 50 mils, $\epsilon_r = 10.2$

TYPICAL TWO-TONE BROADBAND CHARACTERISTICS

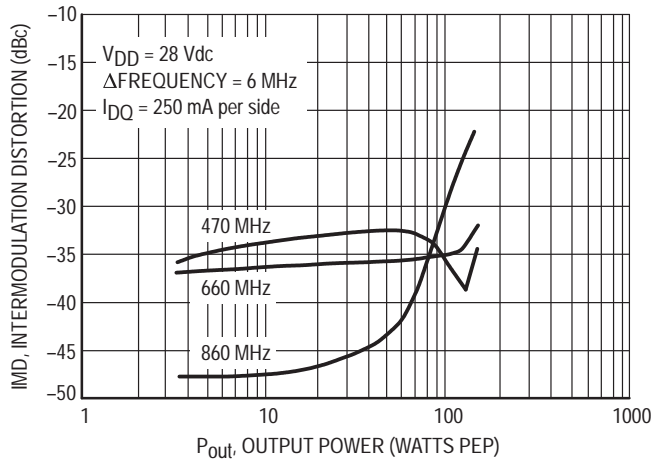

Figure 11. Intermodulation Distortion versus Output Power (MRF373S Broadband Push-Pull Fixture)

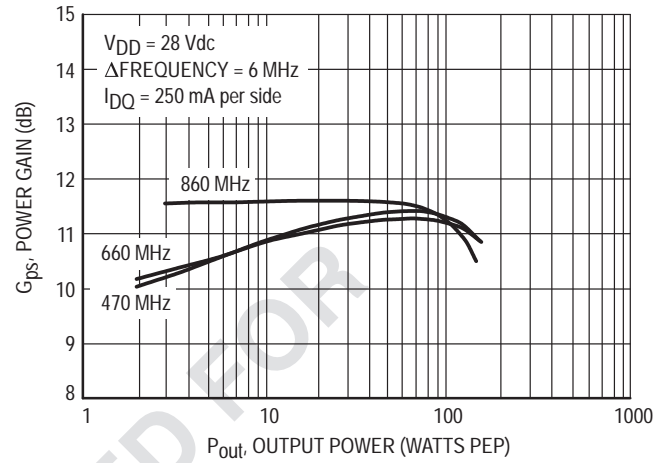

Figure 12. Broadband Power Gain versus Output Power (MRF373S Broadband Push-Pull Fixture)

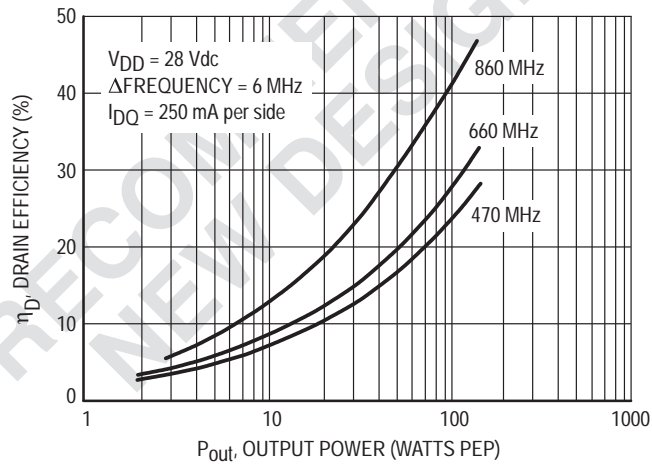

Figure 13. Efficiency versus Output Power (MRF373S Broadband Push-Pull Fixture)

NOTES

NOTES

PACKAGE DIMENSIONS

**CASE 360B-03
ISSUE D
(MRF373)**

NOTES:

- DIMENSIONING AND TOLERANCING PER ANSI Y14.5M, 1982.
- CONTROLLING DIMENSION: INCH.
- DIMENSION H IS MEASURED 0.030" AWAY FROM EDGE OF FLANGE.

DIM	INCHES		MILLIMETERS	
	MIN	MAX	MIN	MAX
A	0.790	0.810	20.07	20.57
B	0.220	0.240	5.59	6.09
C	0.125	0.175	3.18	4.45
D	0.205	0.225	5.21	5.71
E	0.050	0.070	1.27	1.77
F	0.004	0.006	0.11	0.15
G	0.562 BSC		14.27 BSC	
H	0.077	0.087	1.96	2.21
K	0.215	0.255	5.47	6.47
N	0.350	0.370	8.89	9.39
Q	0.120	0.140	3.05	3.55

STYLE 1:
PIN 1. DRAIN
2. GATE
3. SOURCE

**CASE 360C-03
ISSUE B
(MRF373S)**

NOTES:

- DIMENSIONING AND TOLERANCING PER ANSI Y14.5M, 1982.
- CONTROLLING DIMENSION: INCH.

DIM	INCHES		MILLIMETERS	
	MIN	MAX	MIN	MAX
A	0.370	0.390	9.40	9.91
B	0.220	0.240	5.59	6.09
C	0.105	0.155	2.67	3.94
D	0.205	0.225	5.21	5.71
E	0.035	0.045	0.89	1.14
F	0.004	0.006	0.11	0.15
H	0.057	0.067	1.45	1.70
K	0.085	0.115	2.16	2.92
N	0.350	0.370	8.89	9.39

STYLE 1:
PIN 1. DRAIN
2. GATE
3. SOURCE

Motorola reserves the right to make changes without further notice to any products herein. Motorola makes no warranty, representation or guarantee regarding the suitability of its products for any particular purpose, nor does Motorola assume any liability arising out of the application or use of any product or circuit, and specifically disclaims any and all liability, including without limitation consequential or incidental damages. "Typical" parameters which may be provided in Motorola data sheets and/or specifications can and do vary in different applications and actual performance may vary over time. All operating parameters, including "Typicals" must be validated for each customer application by customer's technical experts. Motorola does not convey any license under its patent rights nor the rights of others. Motorola products are not designed, intended, or authorized for use as components in systems intended for surgical implant into the body, or other applications intended to support or sustain life, or for any other application in which the failure of the Motorola product could create a situation where personal injury or death may occur. Should Buyer purchase or use Motorola products for any such unintended or unauthorized application, Buyer shall indemnify and hold Motorola and its officers, employees, subsidiaries, affiliates, and distributors harmless against all claims, costs, damages, and expenses, and reasonable attorney fees arising out of, directly or indirectly, any claim of personal injury or death associated with such unintended or unauthorized use, even if such claim alleges that Motorola was negligent regarding the design or manufacture of the part. Motorola and are registered trademarks of Motorola, Inc. Motorola, Inc. is an Equal Opportunity/Affirmative Action Employer.

Mfax is a trademark of Motorola, Inc.

How to reach us:

USA/EUROPE/Locations Not Listed: Motorola Literature Distribution;
P.O. Box 5405, Denver, Colorado 80217. 1-303-675-2140 or 1-800-441-2447

JAPAN: Motorola Japan Ltd.; SPS, Technical Information Center, 3-20-1,
Minami-Azabu, Minato-ku, Tokyo 106-8573 Japan. 81-3-3440-3569

Customer Focus Center: 1-800-521-6274

Mfax™: RMFAX0@email.sps.mot.com – TOUCHTONE 1-602-244-6609
Motorola Fax Back System – US & Canada ONLY 1-800-774-1848
– http://sps.motorola.com/mfax/

ASIA/PACIFIC: Motorola Semiconductors H.K. Ltd.; Silicon Harbour Centre,
2, Dai King Street, Tai Po Industrial Estate, Tai Po, N.T., Hong Kong.
852-26668334

HOME PAGE: <http://motorola.com/sp/>

