

# The RF Line NPN Silicon RF Power Transistor

The MRF247 is designed for 12.5 Volt VHF large-signal amplifier applications in industrial and commercial FM equipment operating to 175 MHz.

- Specified 12.5 Volt, 175 MHz Characteristics —
  - Output Power = 75 Watts
  - Power Gain = 7.0 dB Min
  - Efficiency = 55% Min
- Characterized With Series Equivalent Large-Signal Impedance Parameters
- Internal Matching Network Optimized for Minimum Gain Frequency Slope Response Over the Range 136 to 175 MHz
- Load Mismatch Capability at Rated P<sub>Out</sub> and Supply Voltage

**MRF247**

**75 W, 175 MHz  
CONTROLLED Q  
RF POWER  
TRANSISTOR  
NPN SILICON**

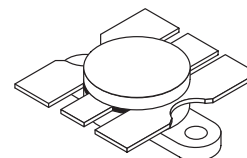

CASE 316-01, STYLE 1

## MAXIMUM RATINGS

Rating	Symbol	Value	Unit
Collector-Emitter Voltage	V <sub>CEO</sub>	18	Vdc
Collector-Base Voltage	V <sub>CBO</sub>	36	Vdc
Emitter-Base Voltage	V <sub>EBO</sub>	4.0	Vdc
Collector Current — Peak	I <sub>C</sub>	20	Adc
Total Device Dissipation @ T <sub>C</sub> = 25°C (1) Derate above 25°C	P <sub>D</sub>	250 1.43	Watts W/°C
Storage Temperature Range	T <sub>stg</sub>	-65 to +150	°C

## THERMAL CHARACTERISTICS

Characteristic	Symbol	Max	Unit
Thermal Resistance, Junction to Case (2)	R <sub>θJC</sub>	0.7	°C/W

## ELECTRICAL CHARACTERISTICS (T<sub>C</sub> = 25°C unless otherwise noted.)

Characteristic	Symbol	Min	Typ	Max	Unit
----------------	--------	-----	-----	-----	------

## OFF CHARACTERISTICS

Collector-Emitter Breakdown Voltage (I <sub>C</sub> = 100 mAdc, I <sub>B</sub> = 0)	V <sub>(BR)CEO</sub>	18	—	—	Vdc
Collector-Emitter Breakdown Voltage (I <sub>C</sub> = 50 mAdc, V <sub>BE</sub> = 0)	V <sub>(BR)CES</sub>	36	—	—	Vdc
Emitter-Base Breakdown Voltage (I <sub>E</sub> = 10 mAdc, I <sub>C</sub> = 0)	V <sub>(BR)EBO</sub>	4.0	—	—	Vdc

- (1) This device is designed for RF operation. The total device dissipation rating applies only when the device is operated as an RF amplifier.  
 (2) Thermal Resistance is determined under specified RF operating conditions by infrared measurement techniques.

NOT RECOMMENDED FOR NEW DESIGN

NOT RECOMMENDED FOR NEW DESIGN

**ELECTRICAL CHARACTERISTICS** ( $T_C = 25^\circ\text{C}$  unless otherwise noted.)

Characteristic	Symbol	Min	Typ	Max	Unit
----------------	--------	-----	-----	-----	------

**ON CHARACTERISTICS**

DC Current Gain ( $I_C = 5.0 \text{ Adc}$ , $V_{CE} = 5.0 \text{ Vdc}$ )	$h_{FE}$	10	75	150	—
---	----------	----	----	-----	---

**DYNAMIC CHARACTERISTICS**

Output Capacitance ( $V_{CB} = 15 \text{ Vdc}$ , $I_E = 0$ , $f = 1.0 \text{ MHz}$ )	$C_{ob}$	—	235	300	pF
---	----------	---	-----	-----	----

**FUNCTIONAL TESTS**

Common-Emitter Amplifier Power Gain ( $V_{CC} = 12.5 \text{ Vdc}$ , $P_{Out} = 75 \text{ Watts}$ , $f = 175 \text{ MHz}$ )	$G_{PE}$	7.0	8.5	—	dB
Collector Efficiency ( $V_{CC} = 12.5 \text{ Vdc}$ , $P_{Out} = 75 \text{ Watts}$ , $f = 175 \text{ MHz}$ )	$\eta$	55	60	—	%
Load Mismatch ( $V_{CC} = 12.5 \text{ Vdc}$ , $P_{Out} = 75 \text{ Watts}$ , $f = 175 \text{ MHz}$ , $VSWR = 30:1$ All Phase Angles)	$\psi$	No Degradation in Output Power			

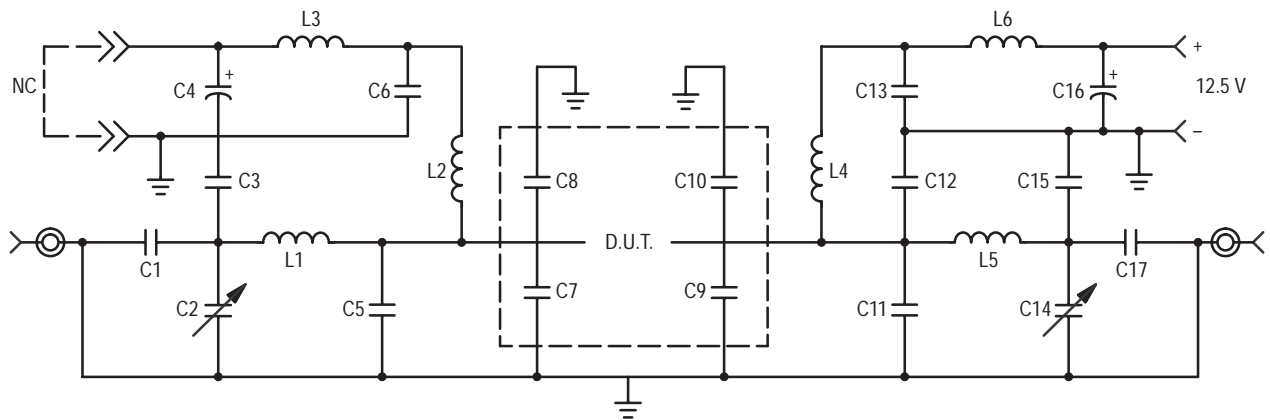

- |         |  |        |   |
|---------|--|--------|---|
| C1, C17 | 330 pF ATC 100 mil Ceramic Capacitor                     | C11    | 150 pF Standard Unelco Clamped Mica Capacitor |
| C2, C14 | Johansen 1–20 pF Trimmer Capacitor                       | C12    | 33 pF Mini-Unelco Clamped Mica Capacitor      |
| C3      | 40 pF Standard Unelco Clamped Mica Capacitor             | C15    | 27 pF Mini-Unelco Clamped Mica Capacitor      |
| C4, C16 | Sprague 10 $\mu\text{F}$ – 35 Vdc Electrolytic Capacitor | L1     | 2 Turns, 16 AWG Enameled, IDIA 0.13"          |
| C5      | 80 pF Standard Unelco Clamped Mica Capacitor             | L2, L4 | 4 Turns, 18 AWG Enameled, IDIA 0.18"          |
| C6, C13 | 91 pF Mini-Unelco Clamped Mica Capacitor                 | L3, L6 | VK 200 with Ferrite Bead                      |
| C7, C8  | 240 pF ATC 100 mil Ceramic Capacitor                     | L5     | 2 Turns, 16 AWG Enameled, IDIA 0.15"          |
| C9, C10 | 180 pF ATC 100 mil Ceramic Capacitor                     |        |   |

**Figure 1. 175 MHz Test Circuit Schematic**

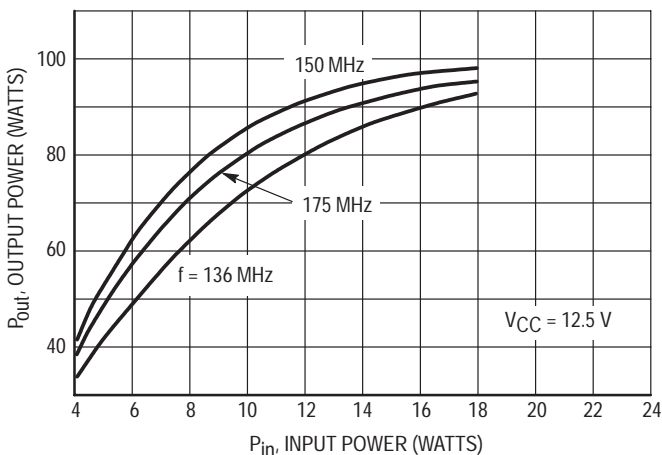

**Figure 2. Output Power versus Input Power**

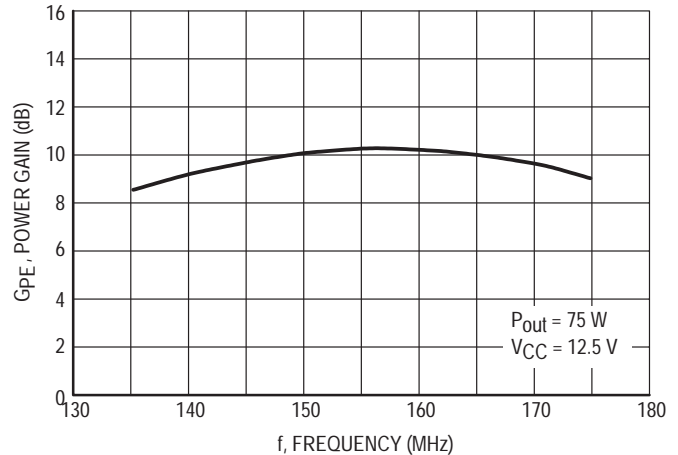

**Figure 3. Power Gain versus Frequency**

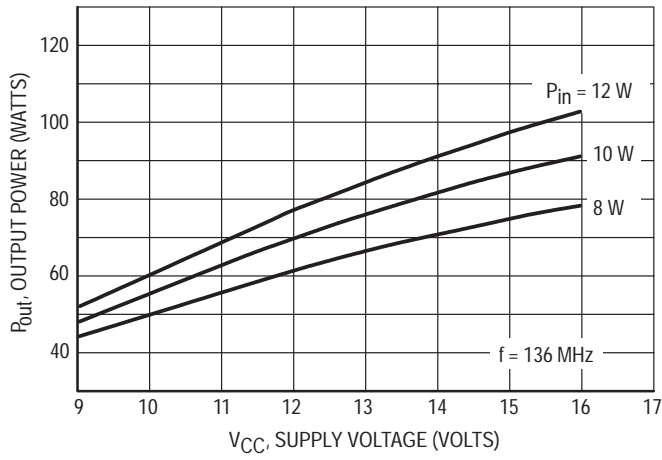

Figure 4. Output Power versus Supply Voltage

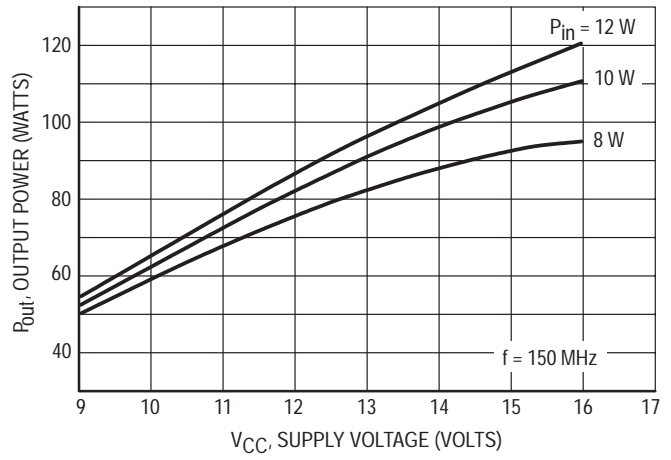

Figure 5. Output Power versus Supply Voltage

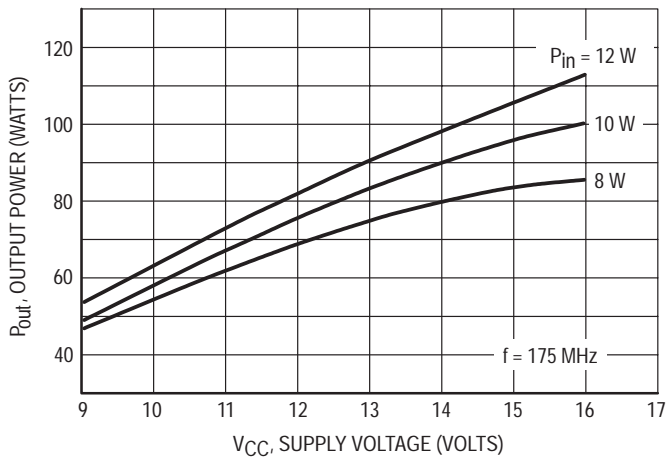

Figure 6. Output Power versus Supply Voltage

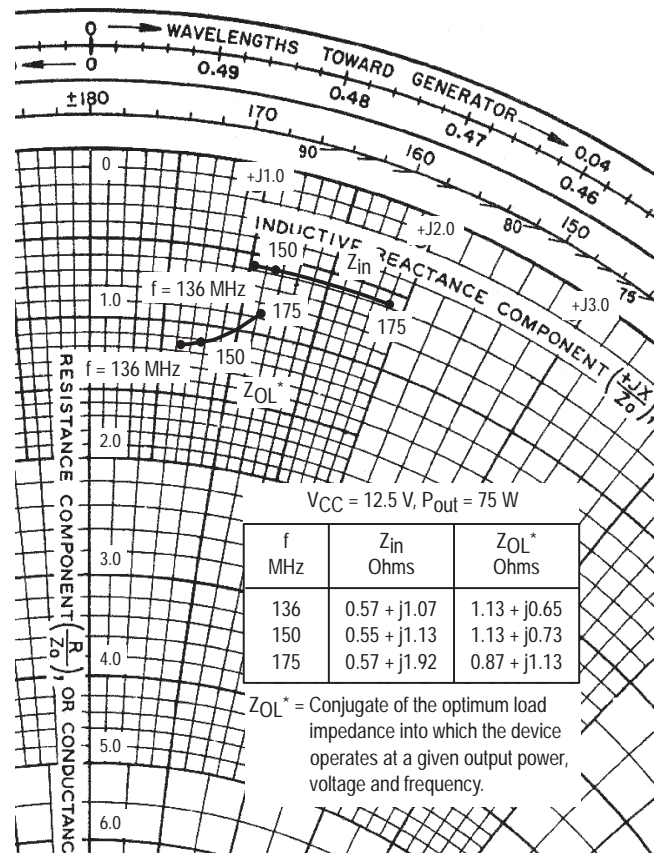
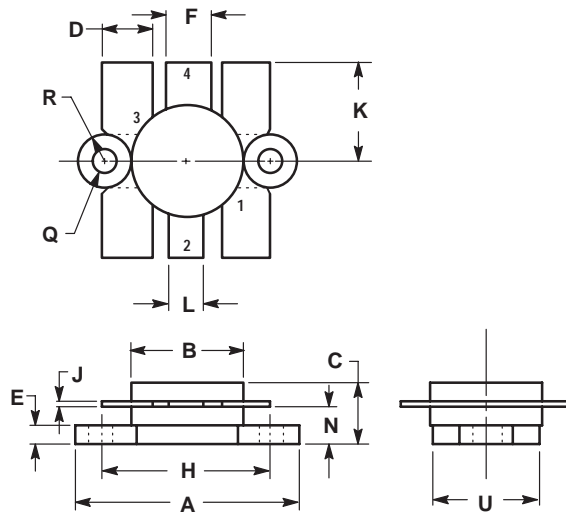

Figure 7. Series Equivalent Impedances

# PACKAGE DIMENSIONS



**NOTES:**

1. FLANGE IS ISOLATED IN ALL STYLES.

DIM	INCHES		MILLIMETERS	
	MIN	MAX	MIN	MAX
A	24.38	25.14	0.960	0.990
B	12.45	12.95	0.490	0.510
C	5.97	7.62	0.235	0.300
D	5.33	5.58	0.210	0.220
E	2.16	3.04	0.085	0.120
F	5.08	5.33	0.200	0.210
H	18.29	18.54	0.720	0.730
J	0.10	0.15	0.004	0.006
K	10.29	11.17	0.405	0.440
L	3.81	4.06	0.150	0.160
N	3.81	4.31	0.150	0.170
Q	2.92	3.30	0.115	0.130
R	3.05	3.30	0.120	0.130
U	11.94	12.57	0.470	0.495

**STYLE 1:**

- PIN 1. EMITTER
- 2. COLLECTOR
- 3. EMITTER
- 4. BASE

**CASE 316-01  
ISSUE D**

Motorola reserves the right to make changes without further notice to any products herein. Motorola makes no warranty, representation or guarantee regarding the suitability of its products for any particular purpose, nor does Motorola assume any liability arising out of the application or use of any product or circuit, and specifically disclaims any and all liability, including without limitation consequential or incidental damages. "Typical" parameters which may be provided in Motorola data sheets and/or specifications can and do vary in different applications and actual performance may vary over time. All operating parameters, including "Typicals" must be validated for each customer application by customer's technical experts. Motorola does not convey any license under its patent rights nor the rights of others. Motorola products are not designed, intended, or authorized for use as components in systems intended for surgical implant into the body, or other applications intended to support or sustain life, or for any other application in which the failure of the Motorola product could create a situation where personal injury or death may occur. Should Buyer purchase or use Motorola products for any such unintended or unauthorized application, Buyer shall indemnify and hold Motorola and its officers, employees, subsidiaries, affiliates, and distributors harmless against all claims, costs, damages, and expenses, and reasonable attorney fees arising out of, directly or indirectly, any claim of personal injury or death associated with such unintended or unauthorized use, even if such claim alleges that Motorola was negligent regarding the design or manufacture of the part. Motorola and  are registered trademarks of Motorola, Inc. Motorola, Inc. is an Equal Opportunity/Affirmative Action Employer.

Mfax is a trademark of Motorola, Inc.

**How to reach us:**

**USA/EUROPE/Locations Not Listed:** Motorola Literature Distribution;  
P.O. Box 5405, Denver, Colorado 80217. 1-303-675-2140 or 1-800-441-2447

**JAPAN:** Motorola Japan Ltd.; SPS, Technical Information Center,  
3-20-1, Minami-Azabu, Minato-ku, Tokyo 106-8573 Japan.  
81-3-3440-3569

**Customer Focus Center: 1-800-521-6274**

**Mfax™:** RMFAX0@email.sps.mot.com – TOUCHTONE 1-602-244-6609  
Motorola Fax Back System – US & Canada ONLY 1-800-774-1848  
– http://sps.motorola.com/mfax/

**ASIA/PACIFIC:** Motorola Semiconductors H.K. Ltd.; Silicon Harbour Centre,  
2, Dai King Street, Tai Po Industrial Estate, Tai Po, N.T., Hong Kong.  
852-26668334

**HOME PAGE:** <http://motorola.com/sps/>



NOT RECOMMENDED FOR NEW DESIGN

NOT RECOMMENDED FOR NEW DESIGN