

Dynamic Switch PLL Clock Driver

The MPC993 is a PLL clock driver designed specifically for redundant clock tree designs. The device receives two differential LVPECL clock signals from which it generates 5 new differential LVPECL clock outputs. Two of the output pairs regenerate the input signals frequency and phase while the other three pairs generate 2x, phase aligned clock outputs. External PLL feedback is used to also provide zero delay buffer performance.

- Fully Integrated PLL
- Intelligent Dynamic Clock Switch
- LVPECL Clock Outputs
- LVCMOS Control/Status I/O
- 3.3V Operation
- 32-Lead TQFP Packaging
- ±50ps Cycle-Cycle Jitter

The MPC993 continuously monitors the two input signals to identify faulty reference clocks. Upon identification of a faulty input clock (input clock stuck HIGH or LOW for at least 3 feedback clock edges), an input bad flag will be set and the device will automatically switch from the bad reference clock input to the good one. During this dynamic switch of the input references, the MPC993 outputs will slew, with minimal period disturbances to the new phase.

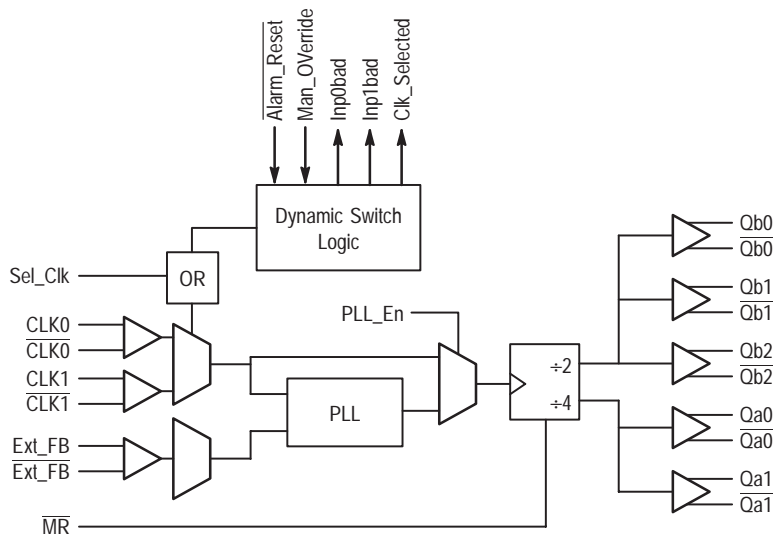

Figure 1. Block Diagram



3.3V PECL AC Characteristics ($T_A = 0^\circ\text{C}$ to 85°C)

Symbol	Parameter	Min	Typ	Max	Unit
f_{VCO}	PLL VCO Lock Range			TBD (Note 5.)	MHz
t_{pwi}		25		75	%
t_{pd}	Propagation Delay (Note 1.) CLKn to Q (Bypass) CLKn to Q (Locked (Note 2.))	X-500 Y-150	2000 0	X+500 Y+150	ps
t_r/t_f	Output Rise/Fall Time	200		800	ps
t_{skew}	Output Skew Within Bank All Outputs			50 100	ps
Δ_{pe}	Maximum Phase Error Deviation			TBD (Note 3.) TBD (Note 4.)	ps
$\Delta_{per/cycle}$	Rate of Change of Periods 75MHz Output (Note 3.) 150MHz Output (Note 3.) 75MHz Output (Note 4.) 150MHz Output (Note 4.)			20 10 TBD TBD	ps
t_{pw}	Output Duty Cycle	45		55	%
t_{jitter}	Cycle-to-Cycle Jitter			50	ps
t_{lock}	Maximum PLL Lock Time			10	ms

1. These values represent simulation results. Final values will be determined from silicon measurements and may be adjusted slightly.
2. Static phase offset between the selected reference clock and the feedback signal.
3. Specification holds for a clock switch between two signals no greater than 400ps out of phase. Delta period change per cycle is averaged over the clock switch excursion. (See Applications Information section on page 4 for more detail)
4. Specification holds for a clock switch between two signals no greater than $\pm\pi$ out of phase. Delta period change per cycle is averaged over the clock switch excursion.
5. The PLL will be unstable using a +2 output as the feedback. Either one of the +4 outputs (Qa0 or Qa1) should be used as the feedback signal.

PIN DESCRIPTIONS

Pin Name	I/O	Pin Definition
CLK0, $\overline{\text{CLK0}}$ CLK1, $\overline{\text{CLK1}}$	LVPECL Input LVPECL Input	Differential PLL clock reference (CLK0 pulldown, $\overline{\text{CLK0}}$ pullup) Differential PLL clock reference (CLK1 pulldown, $\overline{\text{CLK1}}$ pullup)
Ext_FB, $\overline{\text{Ext_FB}}$	LVPECL Input	Differential PLL feedback clock (Ext_FB pulldown, $\overline{\text{Ext_FB}}$ pullup)
Qa0:1, $\overline{\text{Qa0:1}}$	LVPECL Output	Differential 1x output pairs
Qb0:2, $\overline{\text{Qb0:2}}$	LVPECL Output	Differential 2x output pairs
Inp0bad	LVC MOS Output	Indicates detection of a bad input reference clock 0 with respect to the feedback signal. The output is active HIGH and will remain HIGH until the alarm reset is asserted
Inp1bad	LVC MOS Output	Indicates detection of a bad input reference clock 1 with respect to the feedback signal. The output is active HIGH and will remain HIGH until the alarm reset is asserted
Clk_Selected	LVC MOS Output	'0' if clock 0 is selected, '1' if clock 1 is selected
Alarm_Reset	LVC MOS Input	'0' will reset the input bad flags and align Clk_Selected with Sel_Clk. The input is "one-shotted" (50k Ω pullup)
Sel_Clk	LVC MOS Input	'0' selects CLK0, '1' selects CLK1 (50k Ω pulldown)
Manual_Override	LVC MOS Input	'1' disables internal clock switch circuitry (50k Ω pulldown)
PLL_En	LVC MOS Input	'0' bypasses selected input reference around the phase-locked loop (50k Ω pullup)
$\overline{\text{MR}}$	LVC MOS Input	'0' resets the internal dividers forcing Q outputs LOW. Asynchronous to the clock (50k Ω pullup)
VCCA	Power Supply	PLL power supply
VCC	Power Supply	Digital power supply
GND A	Power Supply	PLL ground
GND	Power Supply	Digital ground

Applications Information

The MPC993 is a single switch circuit. The device continuously monitors the two input signals to identify faulty reference clocks. A clock is considered faulty if it has been stuck LOW or HIGH for 3 consecutive feedback clock edges (rising or falling). Upon identifying a faulty reference clock, an input bad flag (Inp0bad or Inp1bad) corresponding to the faulty clock will be set. If the PLL was currently locked to the input signal that goes bad, the MPC993 will automatically switch to the other clock provided it is operational. The input bad flags will remain set until an $\overline{\text{Alarm_Reset}}$ is asserted. The $\overline{\text{Alarm_Reset}}$ input is an active LOW input that will reset the input bad flag(s). Note that the $\overline{\text{Alarm_Reset}}$ is one shot, thus if upon clearing the input bad flags the inputs are still bad the flags will be reset without the $\overline{\text{Alarm_Reset}}$ pin being negated.

If both of the input signals go bad simultaneously the MPC993 PLL will lose lock and the VCO will drift to an indeterminate frequency. Once the MPC993 switches from a bad clock it will continue to use the new clock until the $\overline{\text{Alarm_Reset}}$ pin is asserted. The device will not switch back to a “repaired” bad input clock until the $\overline{\text{Alarm_Reset}}$ is asserted. Asserting the $\overline{\text{Alarm_Reset}}$ pin forces the Clk_Selected output to match the Sel_Clk input. Users identify their primary clock via the Sel_Clk input. If not faulty the MPC993 will always lock to this clock source in the normal mode of operation. The only time clock Clk_Selected does not equal Sel_Clk is when the device is in automatic switch mode and the primary clock source failed. In this condition the MPC993 will have switched to the secondary clock and Clk_Selected will be in the opposite state as Sel_Clk. Note that when in manual override (Man_Override input is asserted) Clk_Selected will always equal Sel_Clk regardless of the condition of the input bad flags.

Whenever the CLK_SELECTED is changed, manually or automatically, the phase detector is suspended. On the next falling edge of the selected CLK the phase detector is restored and the PLL will slew to align the next rising CLK and Ext_FB edges. Upon detection and switch from a “bad” input to a “good” one, the internal PLL of the MPC993 will ensure a smooth phase transition from the original to the new reference clock source. The magnitudes of the disturbances seen in the output clocks are detailed in the AC tables of this data sheet. The two datasheet specifications are the maximum phase error deviation and the rate of change of the output periods during a reference clock switch. The maximum phase error deviation describes the change in the input/output phase difference caused by a switch between two out-of-phase references. The period rate of change describes the behavior of the output signals from the MPC993 as it reacquires phase-lock to the new reference source. The MPC993 will be guaranteed to take the “shortest path” to regain phase lock. That is for a phase difference of -300ps , the output phase will slew 300ps to align to the new phase as opposed to travelling one clock period minus 300ps

in the other direction. This guarantee will ensure edge parity in a clocking scheme in which multiple MPC993's are synchronized in a clock tree and a subset of the devices under go a dynamic switch. Note if the phase of the two input clock sources differs by more than π the direction of phase clock cannot be guaranteed.

To calculate the overall uncertainty between any clocks from multiple MPC993's the following procedure should be followed. Assuming that the reference clocks to the multiple MPC993's are exactly in phase, the total uncertainty will be the combination of the static phase offset uncertainty between the reference and feedback clocks, plus the uncertainty between the feedback clock and the other clock outputs, plus the jitter between the reference clock and feedback clock inputs to the PLL. Any uncertainty in the phase of the reference clocks between the different MPC993's will add directly to this calculated uncertainty.

During a dynamic switch the part to part skew between two devices may be increased for a short period of time. In the condition that only a subset of a number of parallel MPC993's under go a dynamic switch an additional component will need to be added to the part to part skew of the device during this transient event. If the two reference clocks are 400ps out of phase a dynamic switch of an MPC993 will lead to an instantaneous change of the input phase by 400ps without a corresponding change in the output phase due to the limited bandwidth of the PLL. As a result the delay through a device under going the above described switch will change by 400ps until the PLL has an opportunity to slew to its new phase. This transient timing issue should be considered when analyzing the overall skew budget of a system.

The MPC993 inputs are not designed for “hot insertion” applications when the device is used in a PECL environment. In an ECL environment the reference clock inputs to the device are hot insertion compatible. However in a PECL environment a powered down receiver will present a low impedance connection to ground to a powered up driver. To make the MPC993 hot insertion compatible in a PECL environment series resistance needs to be added in front of the input reference clock pins to limit the current in the above mentioned case. For a 3.3V PECL environment a 100Ω series resistor will be sufficient to limit the current to acceptable levels for both the driver and the receiver. A 100Ω series resistor on the reference clock inputs will have minimal impact on the rise and fall times of the input signals.

Acquiring Frequency Lock

1. While the MPC993 is receiving a valid CLK signal, assert Manual Override (Man_Override = HIGH).
2. The PLL will phase and frequency lock within the specified lock time.
3. Apply a HIGH to LOW transition to $\overline{\text{Alarm_Reset}}$ to reset Input Bad flags.
4. De-assert Man_Override and de-assert $\overline{\text{Alarm_Reset}}$ in any order to enable automatic switch mode.

OUTLINE DIMENSIONS

FA SUFFIX
 PLASTIC TQFP PACKAGE
 CASE 873A-02
 ISSUE A

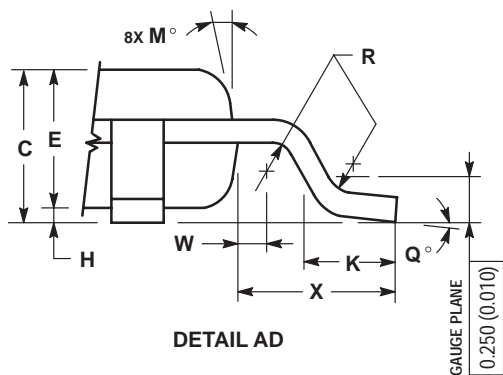
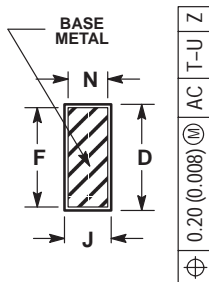
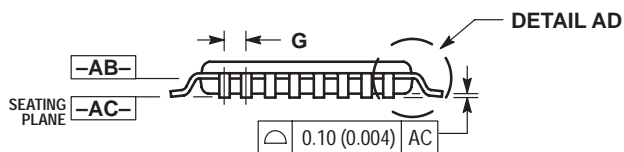
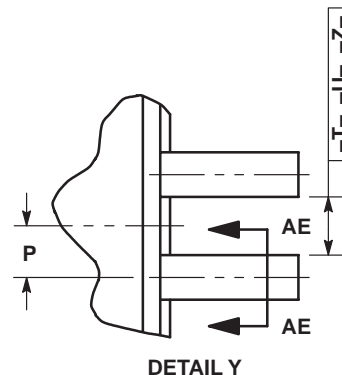
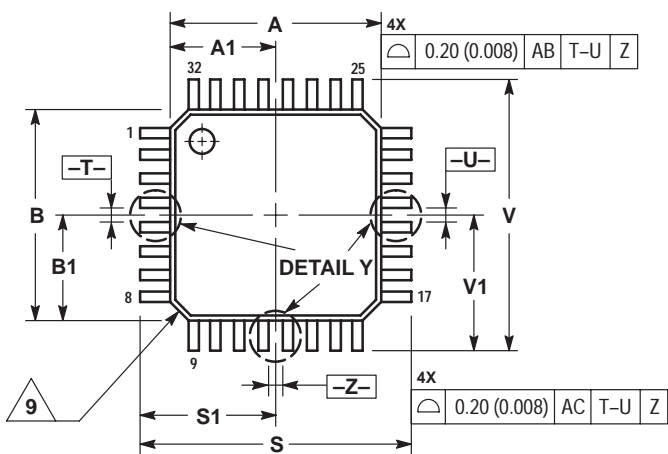

- NOTES:
1. DIMENSIONING AND TOLERANCING PER ANSI Y14.5M, 1982.
 2. CONTROLLING DIMENSION: MILLIMETER.
 3. DATUM PLANE -AB- IS LOCATED AT BOTTOM OF LEAD AND IS COINCIDENT WITH THE LEAD WHERE THE LEAD EXITS THE PLASTIC BODY AT THE BOTTOM OF THE PARTING LINE.
 4. DATUMS -T-, -U-, AND -Z- TO BE DETERMINED AT DATUM PLANE -AB-.
 5. DIMENSIONS S AND V TO BE DETERMINED AT SEATING PLANE -AC-.
 6. DIMENSIONS A AND B DO NOT INCLUDE MOLD PROTRUSION. ALLOWABLE PROTRUSION IS 0.250 (0.010) PER SIDE. DIMENSIONS A AND B DO INCLUDE MOLD MISMATCH AND ARE DETERMINED AT DATUM PLANE -AB-.
 7. DIMENSION D DOES NOT INCLUDE DAMBAR PROTRUSION. DAMBAR PROTRUSION SHALL NOT CAUSE THE D DIMENSION TO EXCEED 0.520 (0.020).
 8. MINIMUM SOLDER PLATE THICKNESS SHALL BE 0.0076 (0.0003).
 9. EXACT SHAPE OF EACH CORNER MAY VARY FROM DEPICTION.

DIM	MILLIMETERS		INCHES	
	MIN	MAX	MIN	MAX
A	7.000 BSC	0.276 BSC		
A1	3.500 BSC	0.138 BSC		
B	7.000 BSC	0.276 BSC		
B1	3.500 BSC	0.138 BSC		
C	1.400	1.600	0.055	0.063
D	0.300	0.450	0.012	0.018
E	1.350	1.450	0.053	0.057
F	0.300	0.400	0.012	0.016
G	0.800 BSC	0.031 BSC		
H	0.050	0.150	0.002	0.006
J	0.090	0.200	0.004	0.008
K	0.500	0.700	0.020	0.028
M	12° REF	12° REF		
N	0.090	0.160	0.004	0.006
P	0.400 BSC	0.016 BSC		
Q	1°	5°	1°	5°
R	0.150	0.250	0.006	0.010
S	9.000 BSC	0.354 BSC		
S1	4.500 BSC	0.177 BSC		
V	9.000 BSC	0.354 BSC		
V1	4.500 BSC	0.177 BSC		
W	0.200 REF	0.008 REF		
X	1.000 REF	0.039 REF		

NOTES

NOTES

Motorola reserves the right to make changes without further notice to any products herein. Motorola makes no warranty, representation or guarantee regarding the suitability of its products for any particular purpose, nor does Motorola assume any liability arising out of the application or use of any product or circuit, and specifically disclaims any and all liability, including without limitation consequential or incidental damages. "Typical" parameters which may be provided in Motorola data sheets and/or specifications can and do vary in different applications and actual performance may vary over time. All operating parameters, including "Typicals" must be validated for each customer application by customer's technical experts. Motorola does not convey any license under its patent rights nor the rights of others. Motorola products are not designed, intended, or authorized for use as components in systems intended for surgical implant into the body, or other applications intended to support or sustain life, or for any other application in which the failure of the Motorola product could create a situation where personal injury or death may occur. Should Buyer purchase or use Motorola products for any such unintended or unauthorized application, Buyer shall indemnify and hold Motorola and its officers, employees, subsidiaries, affiliates, and distributors harmless against all claims, costs, damages, and expenses, and reasonable attorney fees arising out of, directly or indirectly, any claim of personal injury or death associated with such unintended or unauthorized use, even if such claim alleges that Motorola was negligent regarding the design or manufacture of the part. Motorola and  are registered trademarks of Motorola, Inc. Motorola, Inc. is an Equal Opportunity/Affirmative Action Employer.

Mfax is a trademark of Motorola, Inc.

How to reach us:

USA/EUROPE/Locations Not Listed: Motorola Literature Distribution;
P.O. Box 5405, Denver, Colorado 80217. 1-303-675-2140 or 1-800-441-2447

JAPAN: Motorola Japan Ltd.; SPD, Strategic Planning Office, 141,
4-32-1 Nishi-Gotanda, Shinagawa-ku, Tokyo, Japan. 81-3-5487-8488

Customer Focus Center: 1-800-521-6274

Mfax™: RMFAX0@email.sps.mot.com – TOUCHTONE 1-602-244-6609
Motorola Fax Back System – US & Canada ONLY 1-800-774-1848
– <http://sps.motorola.com/mfax/>

ASIA/PACIFIC: Motorola Semiconductors H.K. Ltd.; Silicon Harbour Centre,
2, Dai King Street, Tai Po Industrial Estate, Tai Po, N.T., Hong Kong.
852-26668334

HOME PAGE: <http://motorola.com/sps/>

