

Canon

EOS M



ENGLISH

**INSTRUCTION
MANUAL**

Introduction

The EOS M is a high-performance, interchangeable-lens digital camera featuring a fine-detail CMOS sensor with approx. 18.0 effective megapixels, DIGIC 5, high-precision and high-speed 31-point AF, approx. 4.3 fps continuous shooting, and Full High-Definition (Full HD) movie shooting.

The camera is highly responsive to any shooting situation, and provides many features for demanding shots.

Refer to This Manual while Using the Camera to Further Familiarize Yourself with the Camera

With a digital camera, you can immediately view the image you have captured. While reading this manual, take a few test shots and see how they come out. You can then better understand the camera.

To avoid botched pictures and accidents, first read the “Safety Warnings” (p.333, 334) and “Handling Precautions” (p.16-19).

Testing the Camera Before Use and Liability

After shooting, play images back and check whether they have been properly recorded. If the camera or memory card is faulty and the images cannot be recorded or downloaded to a computer, Canon cannot be held liable for any loss or inconvenience caused.

Copyrights

Copyright laws in your country may prohibit the use of your recorded images or copyrighted music and images with music in the memory card for anything other than private enjoyment. Also be aware that certain public performances, exhibitions, etc., may prohibit photography even for private enjoyment.



This camera is compatible with SD memory cards, SDHC memory cards, and SDXC memory cards. In this manual, “card” refers to all these cards.

* **The camera does not come with a card for recording images/movies.** Please purchase it separately.

Cards that can record movies

When shooting movies, use a large-capacity SD card rated SD Speed Class 6 “CLASS 6” or higher (p.177).

Item Check List

Before starting, check that all the following items have been included with your camera. If anything is missing, contact your dealer.



Camera
(with body cap)



**Battery Pack
LP-E12**
(with protective cover)



**Battery Charger
LC-E12/LC-E12E***

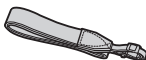

**Neck Strap
EM-100DB**



Interface Cable



**EOS Solution Disk
(Software)**



**EOS Camera
Instruction Manuals
Disk**





**Basic
Instruction Manual**

- * Battery Charger LC-E12 or LC-E12E is provided. (The LC-E12E comes with a power cord.)
- If you purchased a Camera Kit, check that all the components are included. Depending on the Camera Kit, these may include a lens, Speedlite flash or Mount Adapter EF-EOS M.

Conventions Used in this Manual

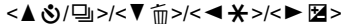
Icons in this Manual

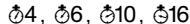
-  : Indicates the Main Dial to be turned.
-  : Indicates the Main Dial buttons on the top, bottom, left, or right to be pressed.
-  : Indicates the Main Dial to be pressed at the center.
-  : Indicates that the corresponding function remains active for 4 sec., 6 sec., 10 sec., or 16 sec. respectively after you let go of the button.

* In this manual, the icons and markings indicating the camera's buttons, dials, and settings correspond to the icons and markings on the camera and on the LCD monitor.

MENU : Press the <MENU> button to set a function.

★ : When shown on the upper right of a page, it indicates that the function is available only in the Creative Zone modes (p.25).

(p.**): Reference page number for more information.

 : Warning to prevent shooting problems.

 : Supplemental information.

 : Tips or advice for better shooting.

?: Problem-solving advice.

Basic Assumptions

- The instructions in this manual assume that the power is on (p.37) and the menu functions and Custom Functions are set to the default settings.
- The illustrations in this manual show the camera attached with the EF-M 18-55mm f/3.5-5.6 IS STM lens as an example.

Chapters

For first-time digital camera users, Chapters 1 and 2 explain the camera's basic operations and shooting procedures.

	Introduction	2
1	Getting Started	31
2	Scene Intelligent Auto + Basic Zone Modes and Image Playback	65
3	Creative Shooting	101
4	Advanced Shooting	141
5	Shooting Movies	177
6	Handy Features	203
7	Image Playback	229
8	Post-Processing Images During Playback	259
9	Printing Images	265
10	Customizing the Camera	281
11	Reference	289
12	Downloading Images to a Personal Computer and Index	337



Contents at a Glance

Shooting

- **Shoot automatically** → **p.65-87** (Basic Zone modes)
- **Blur the background** → **p.75** (Creative Auto)
- **Keep the background in sharp focus**
- **Shoot continuously** → **p.133** (Continuous shooting)
- **Take a picture of yourself in a group** → **p.136** (Self-timer)
- **Freeze the action** → **p.142** (Tv Shutter-priority AE)
- **Blur the action**
- **Create more background blur than with Creative Auto** → **p.144** (Av Aperture-priority AE)
- **Shoot with image effects** → **p.94** (Creative filters)
- **Adjust the image brightness (exposure)** → **p.153** (Exposure compensation)
- **Shoot in low light** → **p.66, 138** (Flash photography)
p.109 (ISO speed setting)
- **Photograph fireworks at night** → **p.150** (Bulb exposure)
- **Shoot movies** → **p.177** (Movie shooting)

Image Quality

- **Shoot with image effects matching the subject** → **p.114** (Picture Style selection)





- **Make a large-size print of the picture** → p.105 (L, L, RAW)
- **Take many pictures** → p.105 (S1, S1, S2, S3)

Focusing

- **Change the point of focus** → p.116 (AF point selection)
- **Shoot a moving subject** → p.81, 131 (Servo AF)

Playback

- **View the images on the camera** → p.98 (Playback)
- **Search for pictures quickly** → p.231 (Index display)
p.232 (Image browsing)
- **Rate images** → p.234 (Ratings)
- **Prevent important images from accidental deletion** → p.252 (Image protect)
- **Delete unnecessary images** → p.254 (Delete)
- **Auto play images and movies** → p.243 (Slide show)
- **View the images or movies on a TV set** → p.247 (Video OUT)
- **Adjust the LCD monitor brightness** → p.207 (LCD monitor brightness)
- **Apply various effects to a photo** → p.260 (Creative filters)

Printing

- **Print pictures easily** → p.265 (Direct printing)



Index to Features

Power

- **Battery**
 - Charging → p.32
 - Installing/Removing → p.34
 - Battery check → p.39
- **Power outlet** → p.290
- **Power saving** → p.38

Card

- **Installing/Removing** → p.34
- **Format** → p.57
- **Release shutter without card** → p.204

Lens

- **Attaching/Detaching** → p.44
- **Zoom** → p.45
- **Image Stabilizer** → p.46
- **AF/MF switching** → p.116

Basic Settings

- **Language** → p.43
- **Zone/Date/Time** → p.40
- **Beeper** → p.204

LCD Monitor

- **Brightness adjustment** → p.207
- **Touch screen** → p.61

Recording Images

- **Creating/Selecting a folder** → p.208
- **File numbering** → p.210

Image Quality

- **Image-recording quality** → p.105
- **Picture Style** → p.114
- **White balance** → p.172
- **Color space** → p.176
- **Image enhancement features**
 - Auto Lighting Optimizer → p.159
 - Lens peripheral illumination correction → p.163
 - Chromatic aberration correction → p.164
 - Noise reduction for long exposures → p.161
 - Noise reduction for high ISO speeds → p.160
 - Highlight tone priority → p.285

AF

- **AF operation** → p.130
- **AF point selection** → p.66
- **Manual focusing** → p.126

Drive

- **Drive mode** → p.24
- **Continuous shooting** → p.133
- **Self-timer** → p.136
- **Maximum burst** → p.106

Shooting

- **Shooting mode** → p.25
- **ISO speed** → p.109
- **Feature guide** → p.60
- **Bulb** → p.150

- Metering mode → p.151
- Remote control → p.291
- Quick Control → p.50
- Creative filters → p.94

Exposure Adjustment

- Exposure compensation → p.153
- AEB → p.155
- AE lock → p.157

Flash

- External flash → p.292
- External flash control → p.220
 - Wireless flash → p.223
- Fill-in flash → p.140

Live View Shooting

- Autofocusing (AF) methods → p.116
- Autofocusing (AF) operation → p.130
- Touch Shutter → p.125
- Aspect ratio → p.108
- Grid display → p.205
- Quick Control → p.50

Movie Shooting

- Movie shooting → p.177
- Sound recording → p.197
- Video snapshot → p.189
- Manual exposure → p.180
- Still photo shooting → p.184
- Quick Control → p.186

Playback

- Image review time → p.205
- Single-image display → p.98
- Shooting information display → p.256
- Index display → p.231
- Image browsing (Jump display) → p.232
- Magnified view → p.231
- Image rotate → p.233
- Rating → p.234
- Movie playback → p.239
- Slide show → p.243
- Viewing images on TV → p.247
- Protect → p.252
- Erase → p.254
- Quick Control → p.236

Image Editing

- Creative filters → p.260
- Resize → p.262

Printing

- PictBridge → p.268
- Print Order (DPOF) → p.275
- Photobook Set-up → p.279

Customization

- Custom Functions (C.Fn) → p.282
- My Menu → p.288

Software

- p.337















Contents



Introduction 2

Item Check List.....	3
Conventions Used in this Manual	4
Chapters	5
Contents at a Glance.....	6
Index to Features	8
Handling Precautions	16
Quick Start Guide	20
Nomenclature	22





1 Getting Started 31

Charging the Battery	32
Installing and Removing the Battery and Card.....	34
Turning on the Power	37
Setting the Time Zone, Date and Time	40
Selecting the Interface Language.....	43
Attaching and Detaching a Lens	44
About the Lens Image Stabilizer	46
Basic Operation.....	48
Quick Control.....	50
MENU Menu Operations.....	54
Formatting the Card	57
Switching the LCD Monitor Display	59
Feature Guide	60
 Using the Touch Screen and Main Dial.....	61

2	Scene Intelligent Auto + Basic Zone Modes and Image Playback	65
	 Fully Automatic Shooting (Scene Intelligent Auto)	66
	 Full Auto Techniques (Scene Intelligent Auto)	71
	Select a Shooting Mode	74
	 Creative Auto Shooting	75
	 Shooting Portraits (Portrait)	78
	 Shooting Landscapes (Landscape)	79
	 Shooting Close-ups (Close-up)	80
	 Shooting Moving Subjects (Sports)	81
	 Shooting Night Portraits (Night Portrait) (With a Tripod)	83
	 Shooting Night Scenes Handheld (Handheld Night Scene)	85
	 Shooting Backlit Scenes (HDR Backlight Control)	86
	 Quick Control for Basic Zone and Scene Intelligent Auto	88
	Shoot by Ambience Selection	89
	Shoot by Lighting or Scene Type	92
	 Using Creative Filters	94
	 Image Playback	98
3	Creative Shooting	101
	P : Program AE	102
	Setting the Image-Recording Quality	105
	ISO: Changing the ISO Speed	109
	 Selecting the Best Picture Style for the Subject	114
	Changing the Focusing Method	116
	 Shooting with the Touch Shutter	125
	MF: Focus Manually	126

AF: Changing the Autofocus Operation	130
 Continuous Shooting	133
 Using the Self-timer.....	136
 Using a Flash.....	138

4 Advanced Shooting 141

Tv : Convey the Subject's Movement	142
Av : Changing the Depth of Field	144
M : Manual Exposure	148
 Changing the Metering Mode	151
Setting Exposure Compensation.....	153
Auto Exposure Bracketing.....	155
 Locking the Exposure (AE Lock).....	157
Auto Correction of Brightness and Contrast.....	159
Noise Reduction Settings	160
Lens Peripheral Illumination / Chromatic Aberration Correction ..	163
 Adjusting the Picture Style	166
 Registering Customized Picture Styles	170
WB: Matching the Light Source	172
 Adjusting the Color Tone for the Light Source	174
Setting the Color Reproduction Range.....	176

5 Shooting Movies 177

 Shooting Movies.....	178
Autoexposure Shooting	178
Manual Exposure Shooting.....	180
Shooting Function Settings	186





Setting the Movie-recording Size	187
Shooting Video Snapshots.....	189
Movie Menu Function Settings.....	197

6 Handy Features 203



Handy Features	204
Disabling the Beeper	204
Card Reminder	204
Setting the Image Review Time	205
Displaying the Grid	205
Setting Power-saving Features (LCD auto off, Camera auto off)	206
Adjusting the LCD Monitor Brightness	207
Creating and Selecting a Folder	208
File Numbering Methods	210
Setting Copyright Information.....	212
Auto Rotation of Vertical Images	214
Checking Camera Settings	215
Reverting the Camera to the Default Settings.....	216
Changing the Shooting Settings Screen Color.....	219
Setting Speedlite Functions	220
🗑 Automatic Sensor Cleaning.....	225
Appending Dust Delete Data	227

7 Image Playback 229





👉 Playing back with the Touch Screen.....	230
📄 Jumping through Images (Jump Display)	232
🔄 Rotating the Image	233
Setting Ratings.....	234
🗑 Quick Control During Playback	236

 Enjoying Movies	237
 Playing Movies	239
 Editing a Movie's First and Last Scenes	241
Slide Show (Auto Playback)	243
Viewing the Images on TV	247
 Protecting Images.....	252
 Erasing Images.....	254
INFO.: Shooting Information Display	256

8 Post-Processing Images During Playback 259

 Creative Filters.....	260
 Resize.....	262

9 Printing Images 265

Preparing to Print	266
 Printing.....	268
Trimming the Image	273
 Digital Print Order Format (DPOF)	275
 Direct Printing with DPOF.....	278
 Specifying Images for a Photobook.....	279

10 Customizing the Camera 281

Setting Custom Functions	282
Custom Function Settings	284
C.Fn I: Exposure	284
C.Fn II: Image	285
C.Fn III: Autofocus	286
C.Fn IV: Operation/Others	286
Registering My Menu	288

11	Reference	289
	Using a Household Power Outlet	290
	Remote Control Shooting	291
	External Speedlites	292
	Using Eye-Fi Cards	294
	Function Availability Table According to Shooting Mode	296
	System Map	298
	Menu Settings	300
	Troubleshooting Guide	311
	Error Codes	323
	Specifications	324
	Safety Warnings	333
12	Downloading Images to a Personal Computer and Index	337
	Downloading Images to a Personal Computer	338
	About the Software	340
	Installing the Software	341
	Camera Instruction Manuals	343
	Index	344

Handling Precautions

Camera Care

- This camera is a precision instrument. Do not drop it or subject it to physical shock.
- Do not point the camera-attached lens toward the sun. The sun's heat can damage the camera's internal components.
- The camera is not waterproof and cannot be used underwater. If you accidentally drop the camera into water, promptly consult the nearest Canon Service Center. Wipe off any water droplets with a dry cloth. If the camera has been exposed to salty air, wipe it with a well-wrung wet cloth.
- Never leave the camera near anything having a strong magnetic field such as a magnet or electric motor. Also avoid using or leaving the camera near anything emitting strong radio waves such as a large antenna. Strong magnetic fields can cause camera incorrect operation or destroy image data.
- Do not leave the camera in excessive heat such as in a car in direct sunlight. High temperatures can cause the camera to malfunction.
- The camera contains precision electronic circuitry. Never attempt to disassemble the camera yourself.
- Do not block the shutter operation with your finger, etc. Doing so may cause a malfunction.
- Use a blower to blow away any dust on the lens. Do not use cleaners that contain organic solvents to clean the camera body or lens. For stubborn dirt, take the camera to the nearest Canon Service Center.
- Do not touch the camera's electrical contacts with your fingers. This is to prevent the contacts from corroding. Corroded contacts can cause camera misoperation.
- If the camera is suddenly brought in from the cold into a warm room, condensation may form on the camera and internal parts. To prevent condensation, first put the camera in a sealed plastic bag and let it adjust to the warmer temperature before taking it out of the bag.
- If condensation forms on the camera, do not use the camera. This is to avoid damaging the camera. If there is condensation, remove the lens, card and battery from the camera, and wait until condensation has evaporated before using the camera.
- If the camera will not be used for an extended period, remove the battery and store the camera in a cool, dry, well-ventilated location. Even while the camera is in storage, press the shutter button a few times once in a while to check that the camera is still working.
- Avoid storing the camera where there are corrosive chemicals such as a darkroom or chemical lab.

- If the camera has not been used for an extended period, test all its functions before using it. If you have not used the camera for some time or if there is an important shoot coming up, have the camera checked by your Canon dealer or check the camera yourself and make sure it is working properly.
- When you detach the lens, the image sensor will be exposed. To prevent scratching the image sensor, do not touch the image sensor.

LCD Monitor

- Although the LCD monitor is manufactured with very high precision technology with over 99.99% effective pixels, there may be a few dead pixels among the remaining 0.01% or less pixels. Dead pixels displaying only black or red, etc., are not a malfunction. They do not affect the images recorded.
- If the LCD monitor is left on for a prolonged period with the same screen displayed, screen burn-in may occur where you see remnants of what was displayed. However, this is only temporary and will disappear when the camera is left unused for a few days.
- The LCD monitor display may seem slow in low temperatures, or look black in high temperatures. It will return to normal at room temperature.
- After changing the LCD monitor's brightness settings, the display may look a little coarse, depending on the subject. This is not a malfunction and will not affect the recorded image.

Cards

To protect the card and its recorded data, note the following:

- Do not drop, bend, or wet the card. Do not subject it to excessive force, physical shock, or vibration.
- Do not touch the card's electronic contacts with your fingers or anything metallic.
- Do not affix any stickers, etc., on the card.
- Do not store or use the card near anything having a strong magnetic field such as a TV set, speakers, or magnet. Also avoid places prone to having static electricity.
- Do not leave the card in direct sunlight or near a heat source.
- Store the card in a case.
- Do not store the card in hot, dusty, or humid locations.

Lens

After detaching the lens from the camera, put down the lens with the rear end up and attach the lens caps to avoid scratching the lens surface and electrical contacts.

Cautions regarding Prolonged Use

If you use continuous shooting, Live View shooting, or movie shooting for a prolonged period, the camera may become hot. Although this is not a malfunction, holding the hot camera for a long period can cause slight skin burns.

About smudges adhering to the front of the sensor

Besides dust entering the camera from outside, in rare cases lubricant from the camera's internal parts may adhere to the front of the sensor. If visible spots still remain after the automatic sensor cleaning, having the sensor cleaned by a Canon Service Center is recommended.

About the lens mount

Periodically cleaning the camera's body and lens mount with a soft lens cleaning cloth is recommended.

Contacts



Quick Start Guide

1

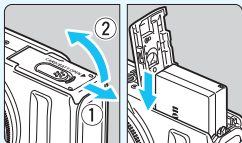

Insert the battery (p.34).

- Charging the battery: p.32

2

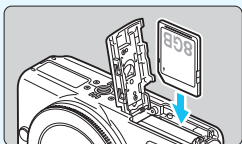

Insert a card (p.34).

- With the card's label facing toward the front of the camera, insert it into the card slot.

3

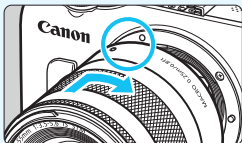

Attach the lens (p.44).

- Align the lens' index with the camera's index.

4

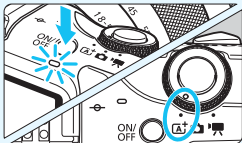

Press the power button to turn on the camera, and set $\langle A^+ \rangle$ (Scene Intelligent Auto) (p.66).

- All the necessary camera settings will be set automatically.
- When the LCD monitor displays the time zone or date/time setting screen, see page 40.

5

**Focus the subject** (p.49).

- Aim the LCD monitor's center over the subject.
- Press the shutter button halfway, and the camera will focus the subject.

6

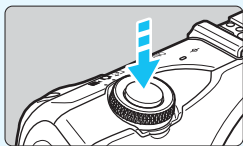
**Take the picture** (p.49).

- Press the shutter button completely to take the picture.

7

**Review the picture** (p.205).

- The captured image will be displayed for approx. 2 sec. on the LCD monitor.
- To display the image again, press the <▶> button (p.98).

- To view the images captured so far, see “Image Playback” (p.98).
- To delete an image, see “Erasing Images” (p.254).
- After you finish shooting, replace the lens cap to protect the lens.

Nomenclature

The names in bold indicate the parts mentioned up until the “Scene Intelligent Auto + Basic Zone Modes and Image Playback” section.

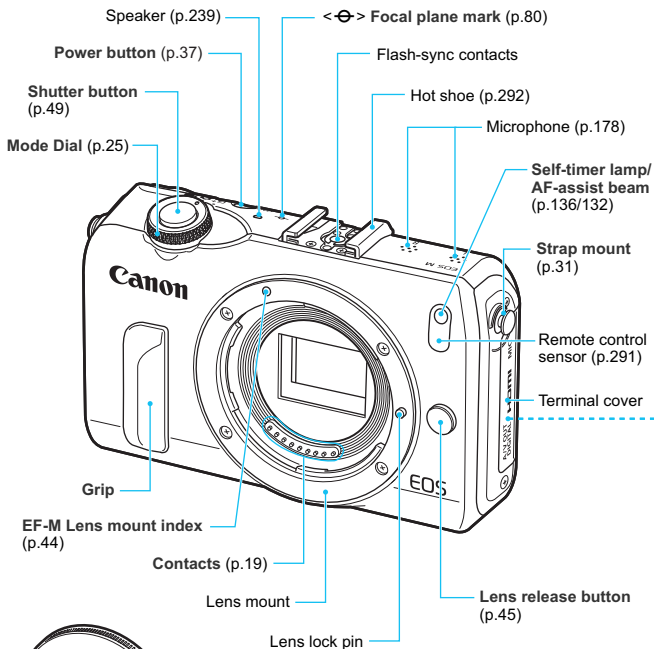

Body cap (p.44)

<MIC> External microphone IN terminal (p.197)

<HDMI OUT> HDMI mini OUT terminal (p.247)

<A/V OUT / DIGITAL > Audio/video OUT / Digital terminal (p.251, 266, 338)

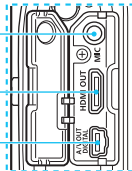

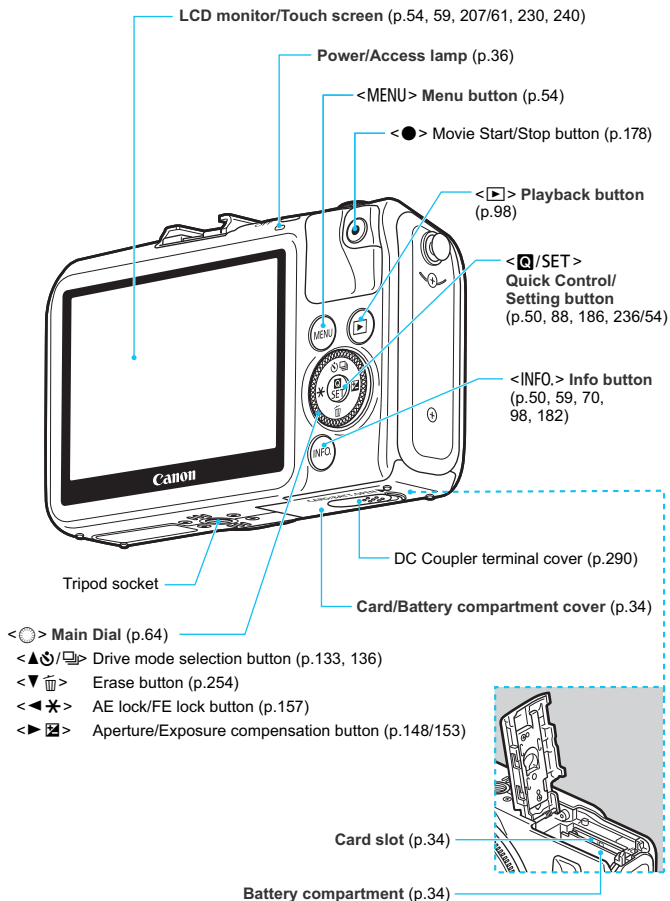

Screen Display (in Creative Zone modes, p.25)

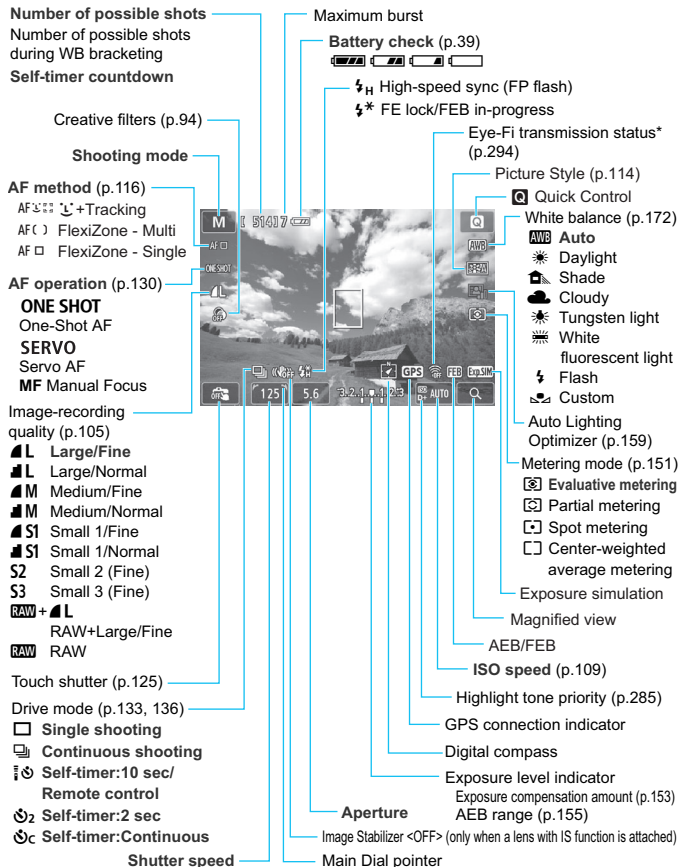

*: Displayed when an Eye-Fi card is used.

The display will show only the settings currently applied.

Mode Dial

Switches to <A+> Scene Intelligent Auto, <📷> Still Photos, or <🎥> Movies.



Shoot still photos with <A+> or <📷>, or shoot movies with <🎥>.

<A+> Scene Intelligent Auto enables you to just press the shutter button to take a picture with the camera taking care of everything to suit the subject or scene.

With <📷> Still photos, you can select Creative Zone modes or the Basic Zone modes.

Creative Zone

These modes give you more control for shooting various subjects.

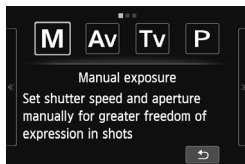

M : Manual exposure (p.148)

Av : Aperture-priority AE (p.144)



Tv : Shutter-priority AE (p.142)

P : Program AE (p.102)

Basic Zone

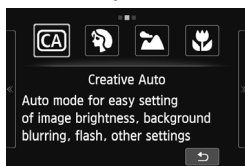
All you do is press the shutter button. The camera sets everything to suit the subject or scene.



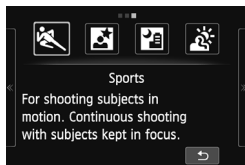

-  : **Creative Auto** (p.75)
-  : **Portrait** (p.78)
-  : **Landscape** (p.79)
-  : **Close-up** (p.80)
-  : **Sports** (p.81)
-  : **Night Portrait** (p.83)
-  : **Handheld Night Scene** (p.85)
-  : **HDR Backlight Control** (p.86)

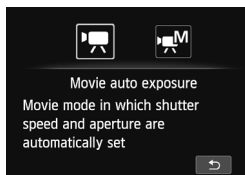

Movies

With Movie, you can select Autoexposure or Manual exposure.



-  : **Movie auto exposure**
-  : **Movie manual exposure**

Lens

EF-M Lens

(Lens with no focus mode switch and no Image Stabilizer switch.)

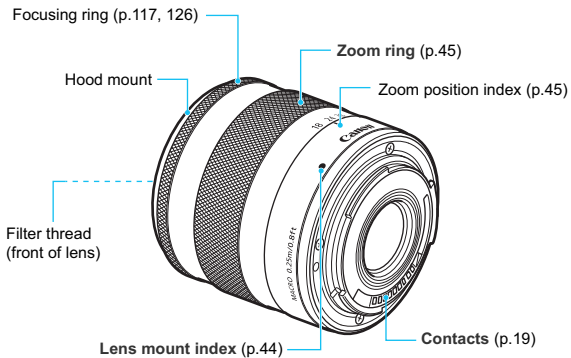

EF or EF-S Lens

(Lens with focus mode switch and Image Stabilizer switch.)

* To attach an EF or EF-S lens to the camera, Mount Adapter EF-EOS M is required.

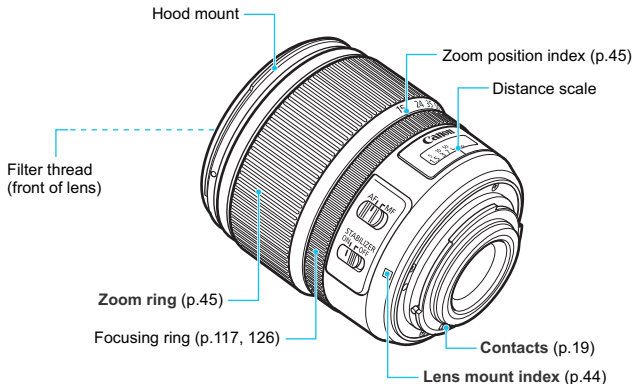

Mount Adapter EF-EOS M

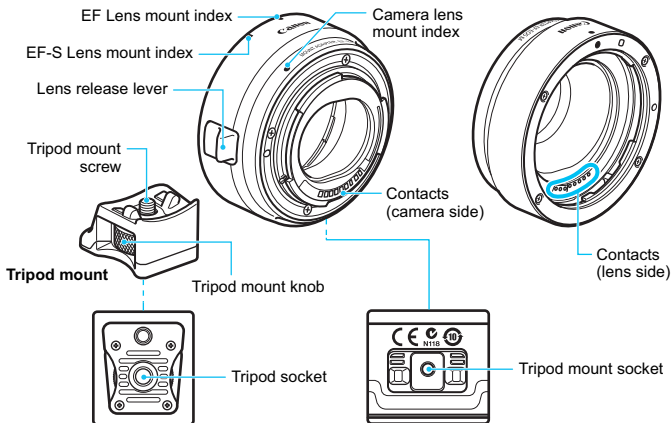

Battery Charger LC-E12

Charger for Battery Pack LP-E12 (p.32).

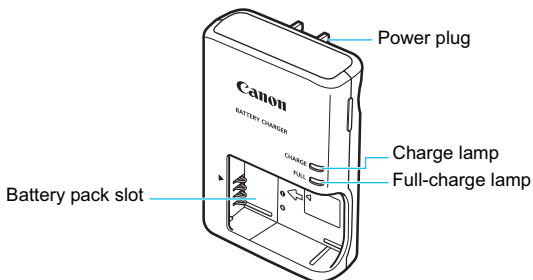

**IMPORTANT SAFETY INSTRUCTIONS-SAVE THESE INSTRUCTIONS.
DANGER-TO REDUCE THE RISK OF FIRE OR ELECTRIC SHOCK,
CAREFULLY FOLLOW THESE INSTRUCTIONS.**

For connection to a supply not in the U.S.A., use an attachment plug adapter of the proper configuration for the power outlet, if needed.

Battery Charger LC-E12E

Charger for Battery Pack LP-E12 (p.32).

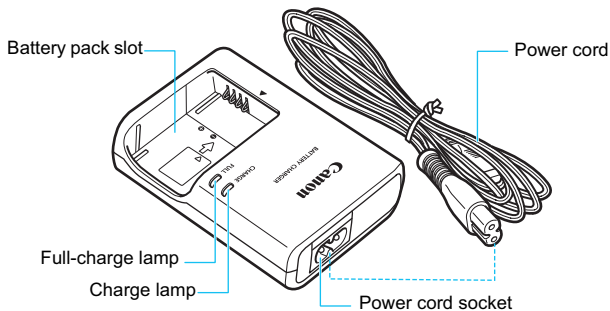





The EOS M was designed with your creativity in mind. Discover new opportunities and see the world around you through new eyes.

1

Getting Started

This chapter explains preparatory steps before you start shooting and basic camera operations.

Attaching the Strap

Fit the strap's metallic ring over the camera's strap mount. Use a coin or similar tool to turn the stopper clockwise until it stops (the index marks are aligned). Make sure the strap's metallic ring is not loose.

Adjust the strap length.

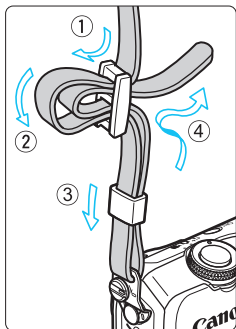
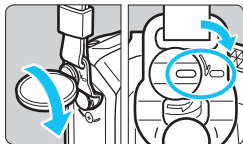
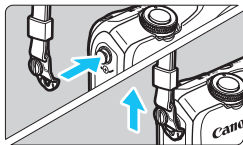

Charging the Battery

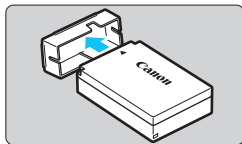

- 1** Remove the protective cover.

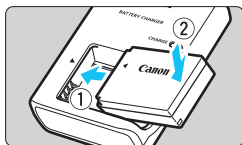

- 2** Attach the battery.

- Align the battery's ◀ mark with the battery charger's ▶ mark.
- To detach the battery, follow the above procedure in reverse.

LC-E12

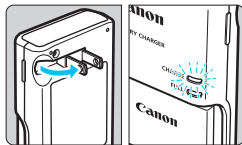

- 3** Recharge the battery.

For LC-E12

- As shown by the arrow, flip out the battery charger's prongs and insert the prongs into a power outlet.

For LC-E12E

- Connect the power cord to the charger and insert the plug into a power outlet.
- ▶ Recharging starts automatically and the charge lamp lights up in orange.
- ▶ When the battery is fully recharged, the full-charge lamp will light up in green.

LC-E12E

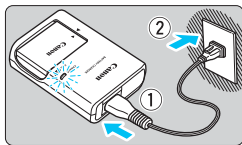

- It takes approx. 2 hours to fully recharge a completely exhausted battery at 23°C / 73°F. The time required to recharge the battery will vary greatly depending on the ambient temperature and the battery's remaining capacity.
- For safety reasons, recharging in low temperatures (5°C - 10°C / 41°F - 50°F) will take longer (up to approx. 4 hours).



Tips for Using the Battery and Charger

- **Upon purchase, the battery is not fully charged.**
Recharge the battery before using.
 - **Recharge the battery on the day before or on the day it is to be used.**
Even during storage, a charged battery will gradually drain and lose its capacity.
 - **After recharging the battery, detach it and disconnect the charger from the power outlet.**
 - **When not using the camera, remove the battery.**
If the battery is left in the camera for a prolonged period, a small amount of power current is released, resulting in excess discharge and shorter battery life. Store the battery with the protective cover (provided) attached. Storing the battery when it is fully charged may lower the battery's performance.
 - **The battery charger can also be used in foreign countries.**
The battery charger is compatible with a 100 V AC to 240 V AC 50/60 Hz power source. If necessary, attach a commercially-available plug adapter for the respective country or region. Do not attach any portable voltage transformer to the battery charger. Doing so can damage the battery charger.
 - **If the battery becomes exhausted quickly even after being fully charged, the battery has reached the end of its service life.**
Purchase a new battery.
-
- After disconnecting the charger's power plug, do not touch the prongs for at least 3 sec.
 - Do not charge any battery other than a Battery Pack LP-E12.
 - Battery Pack LP-E12 is dedicated to Canon products only. Using it with an incompatible battery charger or product may result in malfunction or accidents for which Canon cannot be held liable.

Installing and Removing the Battery and Card

Load a fully charged Battery Pack LP-E12 into the camera. The card (sold separately) can be an SD, SDHC, or SDXC memory card. SDHC and SDXC cards with UHS-I can also be used. The captured images are recorded onto the card.

- 1 **Make sure the card's write-protect switch is set upward to enable writing/erasing.**

Installing the Battery and Card

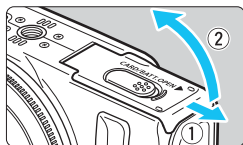

1 Open the cover.

- Slide the lever as shown by the arrows and open the cover.

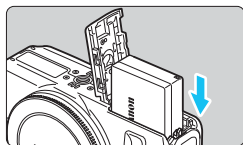

2 Insert the battery.

- The battery's "Canon" logo must be toward the camera's front side as you insert the battery with the battery contacts in first.
- Insert the battery until it clicks and locks in place.

Write-protect switch

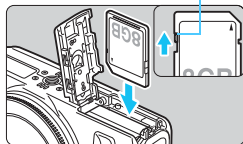

3 Insert the card.

- The card's label side must be toward the front of the camera.
- Insert it straight down until it stops.

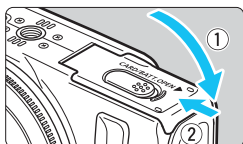

4 Close the cover.

- Press the cover until it snaps shut.
- When you set the power to <ON>, the number of possible shots (p.39) will be displayed on the LCD monitor.



Possible shots

Removing the Battery and Card

1 Set the power to <OFF>.

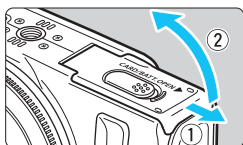

2 Open the cover.

- Make sure the LCD monitor and Power/access lamp are off, then open the cover.
- If [Recording...] is displayed, close the cover.

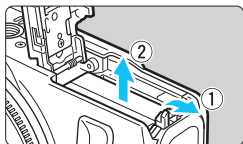

3 Remove the battery.

- 1. Press the battery release lever as shown by the arrow. 2. Remove the battery.
- To prevent short circuiting of the battery contacts, be sure to attach the protective cover (provided, p.32) to the battery.

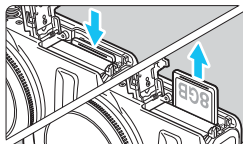



4 Remove the card.

- Gently push in the card, then let go to eject it.
- Pull the card straight out.

5 Close the cover.

- Press the cover until it snaps shut.

 After opening the card/battery compartment cover, be careful not to swing it back further. Otherwise, the hinge may break.

-  ● **When the Power/access lamp is blinking in orange, it indicates that images are being written to or read by the card, being erased, or data is being transferred. Do not open the card/battery compartment cover during this time. Also, never do any of the following while the Power/access lamp is blinking in orange. Otherwise, it can damage the image data, card, or camera.**
- **Removing the card.**
 - **Removing the battery.**
 - **Shaking or banging the camera around.**
- If the card already contains recorded images, the image number may not start from 0001 (p.210).
 - If a card-related error message is displayed on the LCD monitor, remove and reinsert the card. If the error persists, use a different card. If you can transfer all the images on the card to a computer, transfer all the images and then format the card with the camera (p.57). The card may then return to normal.
 - Do not touch the card's contacts with your fingers or metal objects.

Turning on the Power

If you set the power to <ON> and the time zone/date/time setting screen appears, see page 40 to set the time zone and date/time.



Pressing the power button toggles between <ON> and <OFF>.

With the power <OFF>, holding down the <▶> button for 2 sec. or longer will start the playback mode.

- When an EF-M lens is attached to the camera and the power is off, the aperture stops down to shut out the light and protect the inside of the camera. When you set the power to <ON> or <OFF>, the aperture makes a small noise as it opens.

About the Automatic Self-Cleaning Sensor

- When you set the power to <ON>/<OFF> or if [Camera auto off] takes effect and the camera turns off, the image sensor will be cleaned automatically (making a small noise). During the image sensor cleaning after intentionally turning the camera <OFF>, the LCD monitor will display <⏏>.
- If you repeatedly switch the power to <ON>/<OFF> at a short interval, the <⏏> icon may not be displayed. This is normal and not a problem.
- The automatic self-cleaning of the image sensor can be enabled or disabled with the menu (p.225).

MENU Power-saving Features

- To save power, the LCD monitor turns off automatically if you do not operate the camera. If you continue to not operate the camera, the power will turn off automatically. While the LCD monitor is off, pressing any camera button or tapping the LCD monitor will turn it on again. If the power turned off, either press the power button or press the <▶> for at least approx. 2 sec. to turn on the power again.
- You can change the LCD monitor auto off time and Camera auto off time with [**LCD auto off**] and [**Camera auto off**] under [**⚡2: Power saving**] (p.206).





If you set the power to <OFF> while an image is being recorded to the card, [**Recording...**] will be displayed and the power will turn off after the card finishes recording the image.

Checking the Battery Level

When the power is turned on, the battery level will be indicated in one of four levels.



 : Battery level is sufficient.

 : Battery level is low, but the camera can still be used.

 : Battery will be exhausted soon.
(Blinks)

 : Recharge the battery.

Battery Life

Temperature	At 23°C / 73°F	At 0°C / 32°F
Possible shots	Approx. 230 shots	Approx. 200 shots

- The figures above are based on a fully-charged Battery Pack LP-E12 and CIPA (Camera & Imaging Products Association) testing standards.



- The number of possible shots will decrease with any of the following operations:
 - Pressing the shutter button halfway for a prolonged period. (Activating the AF frequently without taking a picture.)
 - Using the lens Image Stabilizer.
- The number of possible shots may decrease depending on the actual shooting conditions.
- The lens operation is powered by the camera's battery. Depending on the lens used, the number of possible shots may be lower.

MENU Setting the Time Zone, Date and Time

When you turn on the camera for the first time, the Time zone and Date/Time setting screen will appear. First set the time zone, then set the date and time.

Note that the shooting date/time appended to the captured images will be based on this date/time setting. Be sure to set the correct date/time.

Set the Time Zone

[London] is set by default.



1 Display the menu screen.

- Press the <MENU> button.

2 Under the [2] tab, select [Time Zone].

- On the Main Dial, press the <◀ * >/ <▶ ☒ > button to select the [2] tab.
- On the Main Dial, press the <▲ ☺ / ☐ >/ <▼ ☒ > button to select [Time Zone], then press <Q/SET >.

3 Set the time zone.

- On the Main Dial, press the <◀ * >/ <▶ ☒ > button to enable the selection of the time zone.
- Press <Q/SET > so <☺ > is displayed.
- On the Main Dial, press the <▲ ☺ / ☐ >/ <▼ ☒ > button to set the time zone, then press <Q/SET >.
- On the Main Dial, press the <◀ * >/ <▶ ☒ > button to select [OK], then press <Q/SET >.

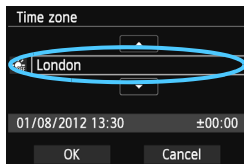



- The menu setting procedure is explained on pages 54-56.
- The time displayed on the lower right is the time difference compared with Coordinated Universal Time (UTC). If you do not see your time zone, set the time zone while referring to the difference with UTC.
- After changing the time zone, check that the correct date/time has been set.
- You can also set the daylight saving time with [F2: Time zone].
- The [F2: Time zone] and [F2: Date/Time] daylight saving time settings are linked.

Set the Date and Time

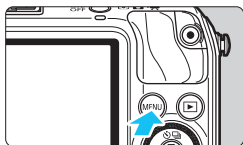

1 Display the menu screen.

- Press the <MENU> button.



2 Under the [F2] tab, select [Date/Time].

- On the Main Dial, press the <◀ * >/ <▶ ☒ > button to select the [F2] tab.
- On the Main Dial, press the <▲ ☺ / ☐ >/ <▼ ☐ > button to select [Date/Time], then press <Q/SET>.

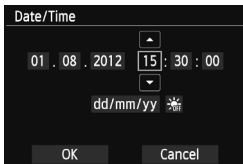

3 Set the date and time.

- On the Main Dial, press the <◀ * >/ <▶ ☒ > button to select the number to be adjusted.
- Press <Q/SET> so <☐ > is displayed.
- On the Main Dial, press the <▲ ☺ / ☐ >/ <▼ ☐ > button to set the number, then press <Q/SET> (returns to <☐ >).

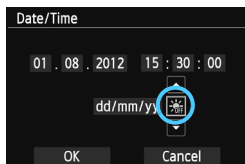

4 Set the daylight saving time.

- Set it if necessary.
- On the Main Dial, press the <◀ * >/ <▶ ☒ > button to select [☀].
- Press <Q/SET > so <☀ > is displayed.
- On the Main Dial, press the <▲ ☹ / ☐ >/ <▼ ☐ > button to select [☀], then press <Q/SET >.
- When the daylight saving time is set to [☀], the time set in step 3 will advance by 1 hour. If [☹] is set, the daylight saving time will be canceled and the time will go back by 1 hour.

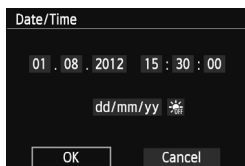

5 Exit the setting.

- On the Main Dial, press the <◀ * >/ <▶ ☒ > button to select [OK], then press <Q/SET >.
- ▶ The date/time and daylight saving time will be set and the menu will reappear.

 If you remove the battery or the battery is exhausted, the time zone and date/time might be reset. If this happens, set the Time zone and Date/Time again.

 To synchronize the seconds, in step 5, press <Q/SET > at 0 sec.



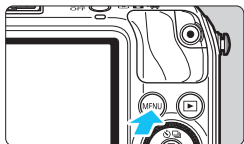

MENU Selecting the Interface Language



- 1 Display the menu screen.
 - Press the <MENU> button.





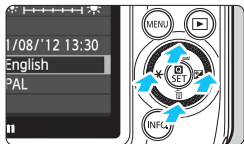

- 2 Under the [**2**] tab, select [Language ].

- On the Main Dial, press the <◀ * >/ <▶  > button to select the [**2**] tab.
- On the Main Dial, press the <▲  /  >/ <▼  > button to select [Language ] (the fifth from the top), then press <Q/SET>.



- 3 Set the desired language.

- On the Main Dial, press the <▲  /  >/ <▼  >/ <◀ * >/ <▶  > button to select the language, then press <Q/SET>.
- ▶ The interface language will change.

English	Norsk	Română
Deutsch	Svenska	Türkçe
Français	Español	العربية
Nederlands	Ελληνικά	ภาษาไทย
Dansk	Русский	简体中文
Português	Polski	繁體中文
Suomi	Čeština	한국어
Italiano	Magyar	日本語
Українська		

Attaching and Detaching a Lens

The camera can use EF-M, EF, and EF-S lenses. To attach an EF or EF-S lens to the camera, Mount Adapter EF-EOS M is required.

Attaching a Lens

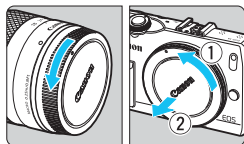

1 Remove the caps.

- Remove the rear lens cap and the body cap by turning them as shown by the arrows.

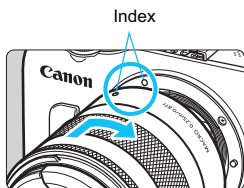

2 Attach the lens.

- Align the lens' index with the camera's index. Turn the lens as shown by the arrow until it clicks in place.

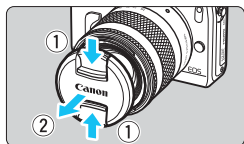

3 Remove the front lens cap.

Minimizing Dust

- When changing lenses, do it quickly in a place with minimal dust.
- When storing the camera without a lens attached, be sure to attach the body cap to the camera.
- Remove dust on the body cap before attaching it.

Detaching the Lens

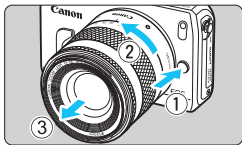

While pressing the lens release button, turn the lens as shown by the arrow.

- Turn the lens until it stops, then detach it.
- Attach the rear lens cap to the detached lens.

About Zooming

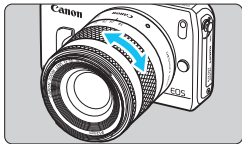

To zoom, turn the zoom ring on the lens with your fingers.

If you want to zoom, do it before focusing. Turning the zoom ring after achieving focus may throw off the focus slightly.



- Do not look at the sun directly through any lens. Doing so may cause loss of vision.
- If the front part (focusing ring) of the lens rotates during autofocus, do not touch the rotating part.
- The focus preset function of some lenses cannot be used with this camera. Also, Power Zoom cannot be used even if you attach a lens featuring the Power Zoom function, like the EF 35-80mm f/4-5.6 POWER ZOOM.



Lens Focal Length (Image Conversion Factor)

Since the image sensor size is smaller than the 35mm film format, it will look like the lens focal length is increased by approx. 1.6x.



Image sensor size (Approx.)
(22.3 x 14.9 mm / 0.88 x 0.59 in.)

35mm image size
(36 x 24 mm / 1.42 x 0.94 in.)

Example: An 18-55mm focal length would be equivalent to an approx. 29-88mm focal length on a 35mm camera.

About the Lens Image Stabilizer

When you use the IS lens' built-in Image Stabilizer, camera shake is corrected to obtain a sharper shot.

* IS stands for Image Stabilizer.

With an EF-M Lens (Operated with a Menu)

Set it with the menu*. By default, it is set to [Enable].

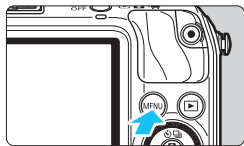

1 Display the menu screen.

- Press the <MENU> button.

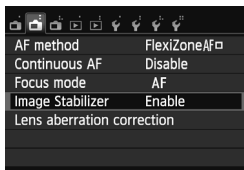

2 Under the [Image Stabilizer] tab, select [Image Stabilizer].

- Press the <◀ * >/<▶ □ > button to select the [Image Stabilizer] tab.
- Press the <▲ Ⓢ / □ >/<▼ □ > button to select [Image Stabilizer], then press <Q/SET >.

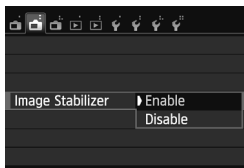

3 Select [Enable].

- Press the <▲ Ⓢ / □ >/<▼ □ > button to select [Enable], then press <Q/SET >.
- Press the <MENU> button.

* This menu is displayed when an EF-M lens with IS function has been attached.

With Lenses other than EF-M (Equipped with a Switch)

Use the IS switch on the lens.

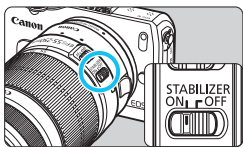

Set the **STABILIZER** switch to **<ON>**.

Using the Image Stabilizer when Shooting

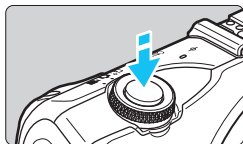

1 Press the shutter button halfway.

- ▶ The Image Stabilizer will operate.

2 Take the picture.

- When the picture looks steady on the LCD monitor, press the shutter button completely to take the picture.



- The Image Stabilizer cannot correct “subject blur”, when the subject moves at the time of exposure.
- For bulb exposures, set the IS to <OFF>. If <ON> is set, Image Stabilizer incorrect operation may occur.
- The Image Stabilizer may not be effective for excessive shaking such as on a rocking boat.



- The Image Stabilizer works in all focus modes.
- When the IS is set to <OFF>, «IS OFF» will appear on the screen.
- When using a tripod, you can still shoot with the IS set to <ON> with no problem. However, to save battery power, setting the IS to <OFF> is recommended.
- The Image Stabilizer is effective even when the camera is mounted on a monopod.

Basic Operation

Holding the Camera

To obtain sharp images, hold the camera still to minimize camera shake.

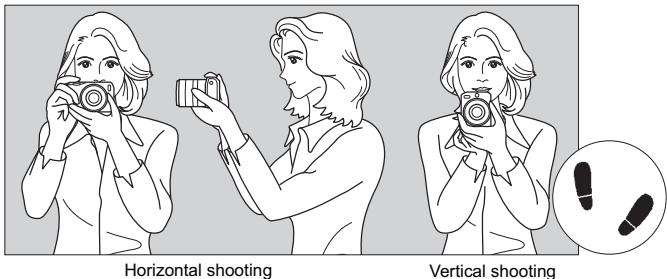

1. Wrap your right hand around the camera grip firmly.
2. Hold the lens bottom with your left hand.
3. Rest your hand's right index finger lightly on the shutter button.
4. Press your arms and elbows lightly against the front of your body.
5. To maintain a stable stance, place one foot slightly ahead of the other.

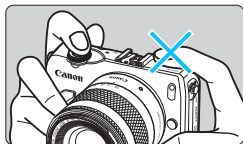

When shooting movies, be careful not to cover the microphone.

Shutter Button

The shutter button has two steps. You can press the shutter button halfway. Then you can further press the shutter button completely.

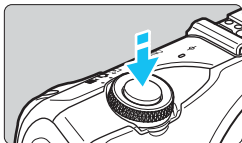

Pressing halfway

The camera will focus and adjust the exposure automatically (shutter speed and aperture set automatically).

The exposure setting (shutter speed and aperture) is displayed (ⓘ16).

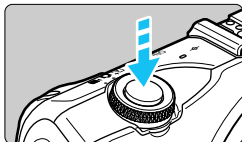

Pressing completely

This releases the shutter and takes the picture.

Preventing Camera Shake

Hand-held camera movement during the moment of exposure is called camera shake. It can cause blurred pictures. To prevent camera shake, note the following:

- Hold and steady the camera as shown on the preceding page.
- Press the shutter button halfway to autofocus, then slowly press the shutter button completely.



- If you press the shutter button completely without pressing it halfway first or if you press the shutter button halfway and then press it completely immediately, the camera will take a moment before it takes the picture.
- Even during menu display, image playback, or image recording, you can instantly go back to shooting-ready by pressing the shutter button halfway.

Quick Control

You can directly select and set the shooting functions displayed on the LCD monitor. This is called the Quick Control screen.

There are two types of Quick Control screens: **Q** Quick Control and INFO. Quick Control.

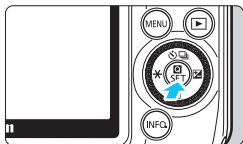

1 **Q** Quick Control

- Tap [**Q**] on the screen or press <**Q**/SET>.

INFO. Quick Control

- Press and hold the <INFO.> button until the INFO. Quick Control screen shown on the next page appears.
- ▶ The Quick Control screen will appear.

2 Set the desired function.

- Tap the function to be set.
- ▶ The selected function and Feature guide will appear.
- On the screen that appears, tap on the function and set it.
- ▶ There are also functions with more settings when you press the <INFO.> button.
- To select and set the function, you can press the Main Dial's <◀*>, <▶☒>, <▲☺/☐>, or <▼☑> button or turn the Main Dial.

Scene Intelligent Auto



Quick Control



INFO. Quick Control

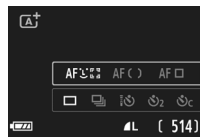

Basic Zone modes

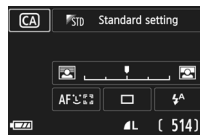

Creative Zone modes



3 Take the picture.

- Press the shutter button completely to take the picture.



Functions that can be set in the Scene Intelligent Auto and Basic Zone modes are on page 88. Functions that can be set in the Creative Zone modes, Movie mode, and playback mode are on pages 52, 186, and 236 respectively.

Functions that can be set with Quick Control

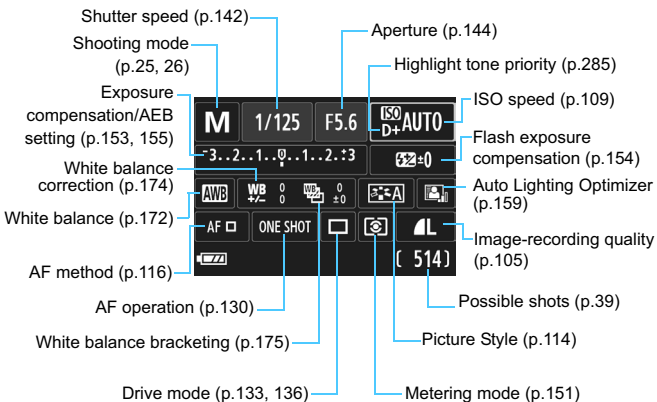
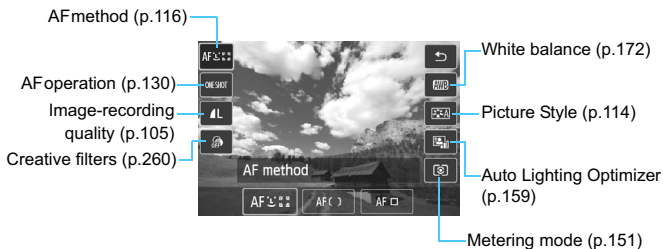

Function Setting Screen



↓ <Q/SET>



↓ <Q/SET>

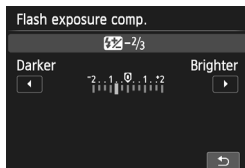

MENU Menu Operations

You can set various settings with the menus such as the image-recording quality, date/time, etc. Operate the menus with the <MENU> button, Main Dial, and <Q/SET> button.

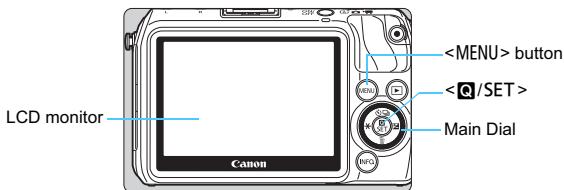

Menu Screen

The menu applicable to the current shooting mode is provided.

Scene Intelligent Auto

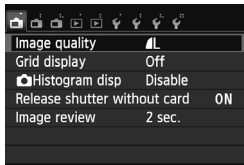
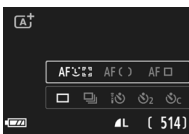

Basic Zone modes

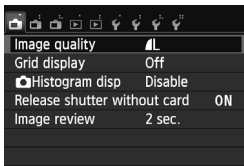
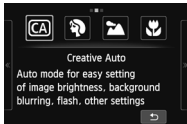

Creative Zone modes

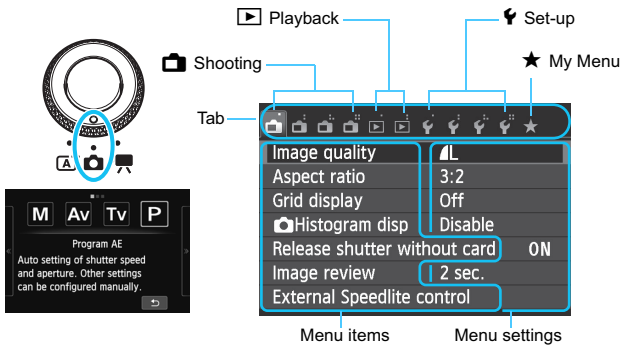

Movie shooting

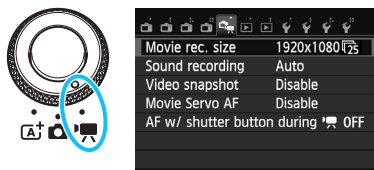

Menu Setting Procedure

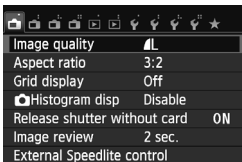

1 Display the menu screen.

- Press the <MENU> button.

2 Select a tab.

- Press the <◀ * >/<▶ ☒ > button to select a tab.
- For example, the [📷3] tab refers to the screen displayed when the 📷 (Shooting) tab's third icon [📷³] from the left is selected.

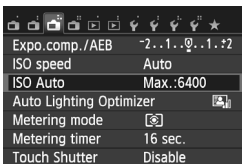

3 Select the desired item.

- Press the <▲ Ⓢ / ☐ >/<▼ ☒ > button to select the item, then press <Q / SET >.

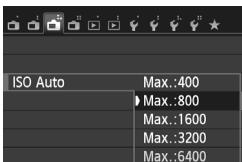

4 Select the setting.

- Press the <▲ Ⓢ / ☐ >/<▼ ☒ > button or <◀ * >/<▶ ☒ > button to select the setting. (There are settings you select with the <▲ Ⓢ / ☐ >/<▼ ☒ > button and settings you select with the <◀ * >/<▶ ☒ > button.)
- The current setting is indicated in blue.

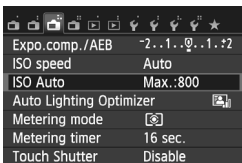

5 Set the desired setting.

- Press <Q / SET > to set it.

6 Exit the setting.

- Press the <MENU> button to return to the shooting settings screen.

- In step 2, you can also turn the <⦿ > dial to select a menu tab.
- In steps 2 to 5, you can also use the LCD monitor's touch screen (p.61).
- To cancel, press the <MENU> button.
- For details about each menu item, see page 300.

MENU Formatting the Card

If the card is new or was previously formatted by another camera or computer, format the card with the camera.

⚠ When the card is formatted, all images and data in the card will be erased. Even protected images will be erased, so make sure there is nothing you need to keep. If necessary, transfer the images to a computer, etc., before formatting the card.

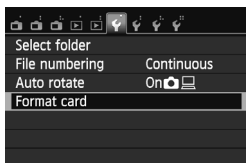

1 Select [Format card].

- Under the [**F**1] tab, select [**Format card**], then press <**Q**/SET>.

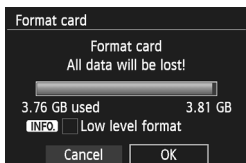

2 Format the card.

- Select [**OK**], then press <**Q**/SET>.
- ▶ When the formatting is completed, the menu will reappear.
- For low-level formatting, press the <INFO> button to append [**Low level format**] with a checkmark <✓>, then select [**OK**].

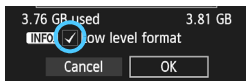

**Execute [Format card] in the following cases:**

- The card is new.
- The card was formatted by a different camera or a computer.
- The card is full with images or data.
- A card error is displayed (p.323).

What is low-level formatting?

- Perform low-level formatting if the card's recording or reading speed seems slow or if you want to totally erase all data in the card.
- Since low-level formatting will format all recordable sectors in the card, the formatting will take slightly longer than normal formatting.
- You can stop the low-level formatting by selecting **[Cancel]**. Even in this case, normal formatting will be completed and you can use the card as usual.

- When the card is formatted or data is erased, only the file management information is changed. The actual data is not completely erased. Be aware of this when selling or discarding the card. When discarding the card, execute low-level formatting or destroy the card physically to prevent the personal data from being leaked.
- **Before using a new Eye-Fi card, the software in the card must be installed in your computer. Then format the card with the camera.**



- The card capacity displayed on the card format screen may be smaller than the capacity indicated on the card.
- This device incorporates exFAT technology licensed from Microsoft.

Switching the LCD Monitor Display

INFO. Quick Control

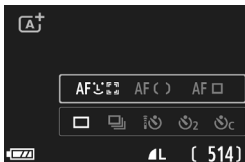

- Each time you press the <INFO.> button, the LCD monitor switches between the Live View screen and INFO. Quick Control (p.50).

Menu

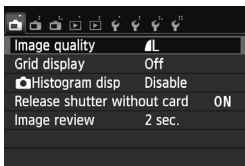

- Appears when you press the <MENU> button. Press the button again to return to the Live View screen.

Captured Image



- Appears when you press the <▶> button. Press the button again to return to the Live View screen.



Even when the menu screen or captured image is displayed, pressing the shutter button will enable you to shoot immediately.

Feature Guide

The Feature guide is a simple description of the respective shooting mode, function, or option. It is displayed when you change the shooting mode or use the Quick Control screen during still photo shooting, movie shooting, or playback. When you select a function or option on the Quick Control screen, the Feature guide description is displayed. When you proceed with the operation, the Feature guide will disappear.

● Shooting mode (Sample)

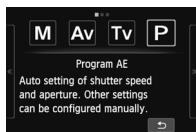
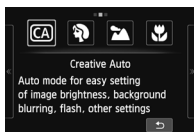

● Quick Control (Sample)



Shooting functions



Live View shooting



Playback

MENU Disabling the Feature Guide

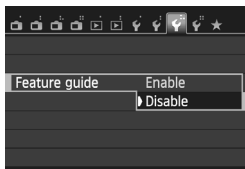

Select [Feature guide].

- Under the [**F3**] tab, select [**Feature guide**], then press <**Q**/SET>. Select [**Disable**], then press <**Q**/SET>.

Using the Touch Screen and Main Dial

The LCD monitor is a touch-sensitive panel that you can operate with your fingers.

Also, on the camera back, you can turn the Main Dial to make a selection and press the dial's top, bottom, left, right, or center.

You can operate this camera by touching the LCD monitor or using the Main Dial (turning it or pressing the top, bottom, left, or right) to select an item, then pressing the Main Dial's center button to set it.

Touch Screen

Tap



Quick Control (Sample display)

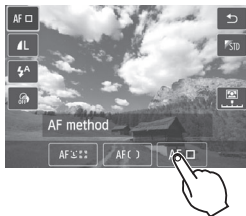

- Use your finger to tap (touch and let go) the LCD monitor.
- By tapping, you can select menus, icons, etc., displayed on the LCD monitor.
- Icons that you can tap are displayed in a frame (except for the menu screen).
- By tapping [>], you can return to the previous screen.



Operations possible by tapping the screen

- Setting menu functions after pressing the <MENU> button
- Quick Control
- Setting a function after you press the <▲ >, <▼ >, <◀ * >, or <▶ > button
- Touch shutter
- Playback operations

Drag

Menu screen (Sample display)

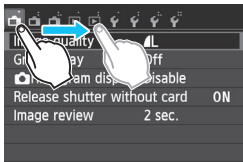

- Slide your finger while touching the LCD monitor.

Scale display (Sample display)

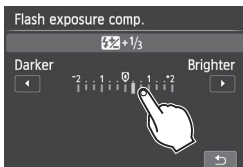

Operations possible by dragging your finger on the screen

- Selecting a menu tab or item after pressing the <MENU> button
- Setting a scale control
- Quick Control
- Playback operations (swipe)

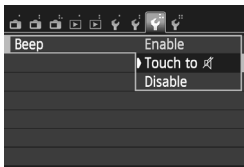
MENU Silencing the Beep during Touch Operations

If [**F3: Beep**] is set to [**Touch to** Disable], the beep will not sound during touch operations.

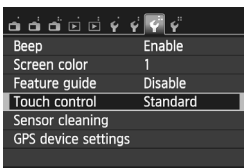
MENU Set the Touch Control**1** Select [Touch control].

- Under the [**F3**] tab, select [**Touch control**], then press <**Q**/SET>.

2 Set the Touch control.

- Normally, set this to [**Standard**].
- Compared to [**Standard**], [**Sensitive**] provides better response to your touch operations. Try using both settings and select the one you prefer.

! Cautions for Touch Screen Operations

- Since the LCD monitor is not pressure sensitive, do not use any sharp objects such as your fingernail, ballpoint pens, etc., for touch operations.
- Do not operate the touch screen with wet hands.
- If the LCD monitor has any moisture or if your fingers are wet, the touch screen may not respond or an incorrect operation may occur. In such a case, turn off the power and wipe the LCD monitor with a cloth.
- Do not attach any protective sheet (commercially available) or sticker on the LCD monitor. It may make the touch operation response slow.

Main Dial

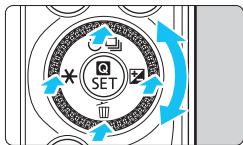

To select a function, you can turn the dial or press the top, bottom, left, and right edges. By pressing < **Q/SET** > at the center, you can set the selected function.



Take your EOS M with you everywhere as your constant companion. Document those special moments, from the extraordinary to the everyday.



Scene Intelligent Auto + Basic Zone Modes and Image Playback

This chapter explains how to shoot with the Scene Intelligent Auto and Basic Zone modes and how to play back images.

Basic Zone modes enable you to just point and shoot by pressing the shutter button. However, you can also blur the background (p.77), apply image effects (p.89), and suit the lighting or scene (p.92).



About the Auto Lighting Optimizer

In Basic Zone modes, the Auto Lighting Optimizer (p.159) will adjust the image automatically to obtain the optimum brightness and contrast. It is also enabled by default in Creative Zone modes.

[A⁺] Fully Automatic Shooting (Scene Intelligent Auto) ■

<[A⁺]> is a fully automatic mode. The camera analyzes the scene and sets the optimum settings automatically.

With Scene Intelligent Auto, the camera always focuses automatically. You can select one of three AF methods with the menu or Quick Control screen.

When you select **[^L (face)+Tracking]**, the person's face will be detected and focused (p.118). **[FlexiZone - Multi]** makes it easier to focus a moving subject (p.120). **[FlexiZone - Single]** uses only one AF point to focus the desired target subject (p.121).

Using **[^L (face)+Tracking]** is explained below.



1 Set the Mode Dial to **<[A⁺]>**.

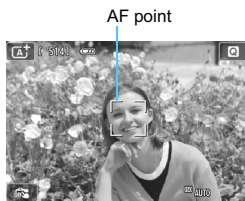

2 Check the AF point.

- When a face is detected, the **<[^L]>** AF point will appear over the face to be focused.
- You can also tap the screen to select the face or subject. If the subject is not a face, **<[^F]₀ [0]>** will be displayed.
- If no faces are detected or if you tap the screen but do not select any face or subject, the camera will switch to **[FlexiZone - Multi]** for automatic selection (p.120).

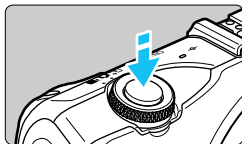

3 Focus the subject.

- Press the shutter button halfway to focus.
- ▶ When focus is achieved, the AF point will turn green and the beeper will sound.

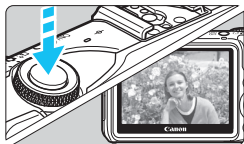

4 Take the picture.

- Press the shutter button completely.
- ▶ The captured image will be displayed for approx. 2 sec. on the LCD monitor.



- The **<A⁺>** mode makes the colors look more impressive in nature, outdoor, and sunset scenes. If the desired color tone is not obtained, use a Creative Zone mode and select a Picture Style other than **<P-A>** and shoot (p.114).
- The image's field of view is approx. 99% (when the image-recording quality is set to JPEG **L**).
- During continuous shooting, the exposure set for the first shot will also be applied to subsequent shots.
- If you do not operate the camera and the time set with **[LCD auto off]** under **[P2: Power saving]** elapses, the LCD monitor will turn off automatically. After the LCD monitor turns off and the time set with **[Camera auto off]** elapses, the power will turn off automatically.
- With a stereo AV cable or HDMI cable (both sold separately), you can display the image being shot on a TV set (p.247, 251).

FAQ

- **The AF point does not turn green and focus is not achieved.**
Try again, aiming the AF point at an area with a good bright/dark contrast, then press the shutter button halfway. Also, focus might not be achieved if you are too close to the subject. Move away from the subject and shoot.
- **Multiple AF points appear in green.**
Focus has been achieved at all the green AF points. When the AF point covering the desired subject turns green, take the picture.
- **Pressing the shutter button halfway does not focus the subject.**
When an EF or EF-S lens is used, if the focus mode switch on the lens is set to <MF> (manual focus), manual focusing will be in effect. Set the focus mode switch to <AF> (autofocus).

With Speedlite 90EX Attached (p.138)

(When you use flash, there is a slight time lag after you press the shutter button completely before the picture is taken.)

- **The flash fired even though it was daylight.**
For a backlit subject, the flash may fire to help lighten the subject's dark areas. If you do not want the flash to fire, switch the Speedlite's power to <OFF>.
- **The flash fired and the picture came out extremely bright.**
Move farther from the subject and shoot. When shooting flash photography, if the subject is too close to the camera, the picture may come out extremely bright (overexposure).
- **The flash fired, but the photo came out dark.**
You were too far away from the subject. See "Effective Flash Range" (p.139) and shoot.
- **When flash was used, the bottom part of the picture came out unnaturally dark.**
The subject was too close to the camera, and a shadow was created by the lens barrel. The subject should be at least 1 meter/3.3 feet away from the camera. If a hood is attached to the lens, remove it before taking the flash picture.

Display Screen During Shooting

- Each time you press the <INFO.> button, the information display will change.

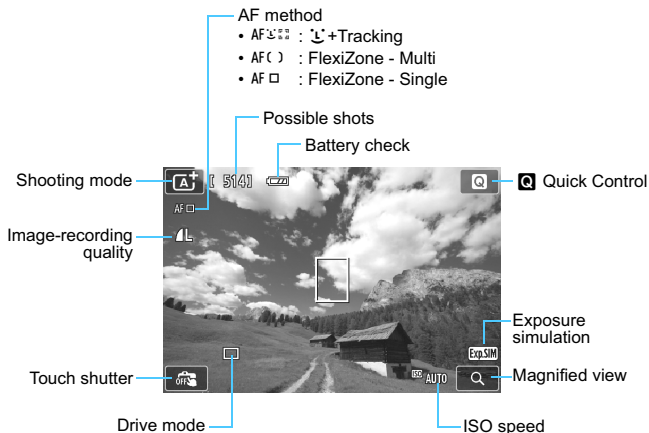

- When <Exp.SIM> is displayed in white, it indicates that the Live View image brightness is close to what the captured image will look like.
- If <Exp.SIM> is blinking, it indicates that the Live View image is not being displayed at the suitable brightness due to low- or bright-light conditions. However, the actual image recorded will reflect the exposure setting.
- With [**Grid 1**] or [**Grid 2**], you can display grid lines to help you level the camera vertically or horizontally (p.205).

A+ Full Auto Techniques (Scene Intelligent Auto)

With a digital camera, you should use a card with ample capacity. If you cannot decide on the composition or which mode to use, you should shoot freely in various compositions and modes. Even if the picture is slightly blurred, it can still convey something. You can always erase failed or unwanted images, so be sure to try many different shots.

Recomposing the Shot



Depending on the scene, instead of having the subject at the center, you should put the subject toward the right or left and include some background. This gives the picture more balance and depth.

While you press the shutter button halfway to focus a still subject, the focus will be locked at the subject's distance. Then aim the camera to the right or left and press the shutter button completely. This is called "focus lock". Focus lock is also possible in other Basic Zone modes (except Sports).

Scene Icons

When you shoot in the <**A⁺**> mode, an icon representing the scene detected by the camera will be displayed.

Subject \ Background	Portrait ^{*1}		Non-Portrait			Background Color
		Movement	Nature and Outdoor Scene	Movement	Close ^{*2}	
Bright						Gray
Backlit						
Blue sky included						Light blue
Backlit						
Sunset	*3			*3		Orange
Spotlight						Dark blue
Dark						
With tripod	*4*5	*3	*4*5	*3		

*1 : Displayed only when the AF method is set to [**L** +Tracking]. If another AF method is set, the “Non-Portrait” icon will be displayed even if a person is detected.

*2 : Displayed when the attached lens has distance information. With an Extension Tube or Closeup Lens, the icon displayed may not match the actual scene.

*3 : The icon suiting the scene detected will be displayed.

*4 : Displayed when you use a tripod for a low-light or night scene.

<→ Continued on next page>

*5 : Displayed with any of the lenses below:

- EF 24mm f/2.8 IS USM
- EF 28mm f/2.8 IS USM
- EF 300mm f/2.8L IS II USM
- EF 400mm f/2.8L IS II USM
- EF 500mm f/4L IS II USM
- EF 600mm f/4L IS II USM
- EF-S 18-55mm f/3.5-5.6 IS II
- EF-S 18-135mm f/3.5-5.6 IS STM
- EF-S 55-250mm f/4-5.6 IS II
- IS lenses marketed in 2012 or later.

* For certain scenes, the icon displayed may not match the actual scene.

Final Image Simulation

The final image simulation is a function that allows you to see the effects of the Picture Style, white balance, etc., on the image.

The following settings will be automatically reflected.

- Picture Style
 - * All settings such as sharpness, contrast, color saturation, and color tone will be reflected.
- White balance
- White balance correction
- Ambience-based shots
- Light/scene-based shots
- Creative filters (when using [**Soft focus**] and [**Toy camera effect**], with depth-of-field preview button ON)*
- Metering mode
- Exposure
- Depth of field (with depth-of-field preview button ON)*
- Auto Lighting Optimizer
- Peripheral illumination correction
- Highlight tone priority
- Aspect ratio (image area confirmation)

* With the menu's Custom Function C.Fn-6 set to "Depth-of-field preview".



Using the final image simulation you can check the effects of various settings on the image but the colors displayed on the screen will not fully match those of the recorded image.

Select a Shooting Mode

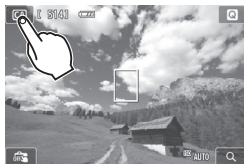

1 Tap the shooting mode icon on the screen's upper left corner.

- The shooting mode selection screen will appear.

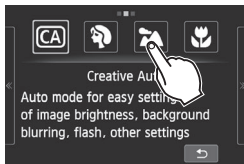

2 Tap the screen to select a shooting mode.

- You can also select the shooting mode on the INFO, Quick Control screen.









With

Tap the arrow on either side of the screen to go to another page. The shooting mode screen has three pages, the Creative Zone screen has one page, and the Basic Zone screen has two pages.



Creative Zone modes

You can select the following: **M**: Manual, **Av**: Aperture-priority AE, **Tv**: Shutter-priority AE, and **P**: Program AE.

Basic Zone modes

: Creative Auto, : Portrait, : Landscape, : Close-up, : Sports, : Night Portrait, : Handheld Night Scene, : HDR Backlight Control

With

: Autoexposure, : Manual exposure

CA Creative Auto Shooting

In the <CA> mode, you can easily blur the background, change the drive mode or control the firing of an attached Speedlite flash. You can also choose the ambience you want to convey in your images. The default settings are the same as the <A+> mode.

* CA stands for Creative Auto.



1 Turn the Mode Dial to <CA>, then select <CA> on the screen.



2 Display the Quick Control screen.

- With the **Q** Quick Control screen, you can check the effect while setting the function (except for [Backgnd:Blurred <-> Sharp]).



3 Set the desired function.

- Select the function, then tap [**↵**].
- ▶ The selected function and Feature guide (p.60) will appear.
- For setting procedure and details on each function, see pages 76-77.

4 Take the picture.

- Press the shutter button.



If you change the shooting mode or set the power to <OFF>, the functions you have set on this screen will revert to their default setting. However, the AF method, image-recording quality, self-timer and remote control settings will be retained. With Creative Zone modes that allow the use of creative filters, the creative filter settings will be retained as well.

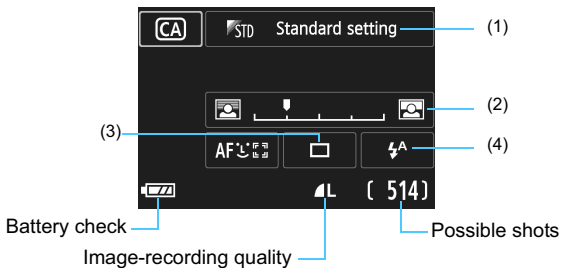

(1) Ambience-based shots (Q Quick Control / INFO, Quick Control)
You can choose the ambience you want to convey in your images.

(2) Blurring/Sharpening the background ( Quick Control / INFO. Quick Control)



If you move the index mark toward the left, the background will look more blurred. If you move it toward the right, the background will look more in focus. If you want to blur the background, see “Shooting Portraits” on page 78.

Depending on the lens and shooting conditions, the background may not look so blurred. If flash is used, this setting will not be applied.

(3) Drive mode (INFO. Quick Control)

<  > **Single shooting:**

Shoot one image at a time.

<  > **Continuous shooting:**

While you hold down the shutter button completely, shots will be taken continuously. You can shoot up to approx. 4.3 shots per sec.



<  > **Self-timer: 10sec./remote:**

The picture is taken 10 seconds after you press the shutter button. A remote controller can also be used.

<  > **Self-timer: 2sec.:**

The picture is taken 2 seconds after you press the shutter button.

<  > **Self-timer: Continuous:**

Tap []/[] to set the number of multiple shots (2 to 10) to be taken with the self-timer. 10 seconds after you press the shutter button, the set number of multiple shots will be taken.



(4) Attached Speedlite 90EX flash firing ( Quick Control / INFO. Quick Control)

<  > **Auto flash** : The flash fires automatically when necessary.

<  > **Flash on** : The flash fires at all times.

<  > **Flash off** : The flash is disabled.

* When a flash other than the Speedlite 90EX is attached, the flash mode will be set to Flash on.

 When using the self-timer, see the  notes on page 137.

Shooting Portraits (Portrait)

This mode blurs the background to make the person stand out better. It also makes skin tones and the hair look softer.

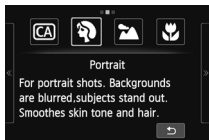

Shooting Tips

- **The further the distance between the subject and background, the better.**

The further the distance between the subject and background, the more blurred the background will look. The subject will also stand out better in front of a plain, dark background.

- **Use a telephoto lens.**

If you have a zoom lens, use the telephoto end to fill the frame with the subject from the waist up. Move in closer if necessary.

- **Focus the face.**

Check that the AF point covering the face turns green.



- The default setting is (continuous shooting). If you hold down the shutter button, you can shoot continuously to obtain different poses and facial expressions (max. approx. 4.3 shots/sec.).
- Using the Speedlite 90EX or similar flash in Portrait mode is recommended.

Shooting Landscapes (Landscape)

Suited for wide scenes when you want everything to be in focus from near to far. For vivid blues and greens, and very sharp and crisp images.

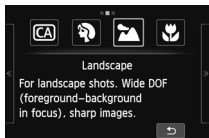

Shooting Tips

- **With a zoom lens, use the wide-angle end.**
When using the wide-angle end of a zoom lens, objects near and far will be in focus better than at the telephoto end. It also adds breadth to landscapes.
- **Shooting night scenes.**
Since the flash will be disabled, this mode < > is also good for night scenes. Use a tripod to prevent camera shake.

Shooting Close-ups (Close-up)

For shooting flowers and small objects up close. To make small things appear much larger, use a macro lens (sold separately).

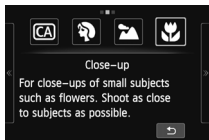

Shooting Tips

- **Use a simple background.**

When the background has no other flowers, leaves, etc., the close-up subject will stand out more.

- **Move as close as possible to the subject.**

Check the lens for its minimum focusing distance. Some lenses have indications such as $\langle \text{🌻 } 0.25\text{m}/0.8\text{ft} \rangle$. (This example indicates a minimum focusing distance of 25 cm/0.8 ft.) The lens minimum focusing distance is measured from the $\langle \ominus \rangle$ (focal plane) mark (on the left of the hot shoe) to the subject. If you get too close to the subject, focus cannot be achieved.

- **With a zoom lens, use the telephoto end.**

If you have a zoom lens, using the telephoto end will make the subject look larger.

Shooting Moving Subjects (Sports)

Use this mode to photograph a moving subject.

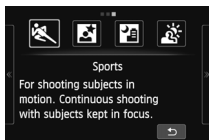

Shooting Tips

● **Shoot continuously.**

When you press the shutter button halfway, the camera will focus and the AF point will be fixed.

While the camera focuses, the beeper will sound. If focus cannot be achieved, the AF point will turn orange.

When the right moment comes, press the shutter button completely to take the picture. If you hold down the shutter button completely, the camera will keep focusing and shooting continuously so you can capture the changing movement.

The continuous shooting speed (maximum number of frames per second) depends on the lens used.

- EF-M 18-55mm f/3.5-5.6 IS STM: approx. 1.7 fps
- EF-M 22mm f/2 STM: approx. 1.2 fps
- EF and EF-S lenses: approx. 4.3 fps

 See also the cautions on page 131.

-  Under low light, when camera shake is prone to occur, the LCD monitor's shutter speed display on the bottom left will blink. Hold the camera steady and shoot.

Shooting Night Portraits (Night Portrait) (With a Tripod)

Attach Speedlite 90EX and shoot portraits with a beautiful and bright night scene in the background.

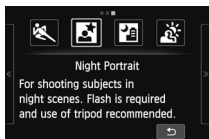

Shooting Tips

- **Use a wide-angle lens and a tripod.**
When using a zoom lens, use the wide-angle end to obtain a wide night view. Also, use a tripod to prevent camera shake.
- **Take portraits without flash.**
When the Speedlite's power is <ON>, the Speedlite will fire a flash automatically under low-light conditions to obtain a nice portrait. You should then play back the image to check the image brightness. If the subject looks dark, move nearer and shoot again. The effective range of the flash is explained in "Effective Flash Range" on page 139. When shooting a night scene without a human subject, turn off the Speedlite.
- **Also shoot in another shooting mode.**
Since camera shake is prone to occur with night shots, shooting also with <A+> and <P> is recommended.



- Tell the subject to keep still even after the flash fires.
- If you use a flash with the self-timer, the self-timer/AF-assist beam lamp will light up briefly after the picture is taken.
- When shooting night scenes or other scenes where multiple point-like light sources appear on the screen, the camera may not be able to focus automatically. In such cases, setting the [AF method] to [FlexiZone - Single] is recommended. If the camera still cannot focus automatically, set the focus mode to [MF] and focus manually.

Shooting Night Scenes Handheld (Handheld Night Scene)

For shooting night scenes while handholding the camera. When you take a picture, four shots are taken continuously to produce a single, bright photo that reduces camera shake.

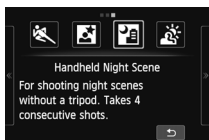

Shooting Tips

- **Hold the camera firmly.**

While shooting, hold the camera firmly and steadily. If the continuous shots are very misaligned due to camera shake, etc., they may not align properly in the final image.

With Speedlite 90EX Attached

- **If you will only shoot a night scene, turn off the Speedlite.**

If you are shooting only the night scene, turn off the flash.

- **If you are also photographing a person, turn on the Speedlite.**

To take a nice portrait, the first shot will use flash. Tell the person not to move until all four continuous shots are taken. The effective range of the flash for human subjects is explained in “Effective Flash Range” on page 139.

 See the cautions on page 87.

Shooting Backlit Scenes (HDR Backlight Control) ■

When shooting a scene having both bright and dark areas. When you take a picture, three continuous shots will be taken at different exposures. The loss of detail in highlights and shadows will be reduced in the final image.

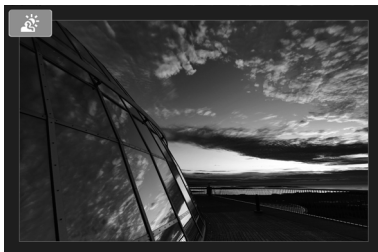
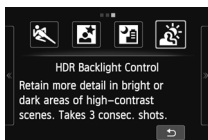

Shooting Tips

● Hold the camera firmly.

While shooting, hold the camera firmly and steadily. If the continuous shots are very misaligned due to camera shake, etc., they may not align properly in the final image.



- The AF-assist beam will be emitted.
- Flash cannot be used.
- See the cautions on page 87.



Cautions for <P>

- When shooting night scenes and other scenes with multiple point-like light sources, the camera may not be able to focus automatically. In such cases, set the focus mode to [MF] and focus manually.
- When shooting flash photography, if the flash fires and the subject's background is close enough to be illuminated by the flash or the night scene has only few lights, the shots may not align correctly. This can result in a blurry photo.
- When shooting flash photography, if the subject is too close to the camera, the picture may come out extremely bright (overexposure).
- When using a Speedlite with automatic flash coverage setting, the zoom position will be fixed to the wide end, regardless of the lens' zoom position.

When using a Speedlite with manual flash coverage switch, shoot with the flash head retracted to the wide (normal) position.

Cautions for <A>

- Note that the image may not be rendered with a smooth gradation and may look irregular or have significant noise.
- HDR Backlight Control may not be effective for excessively backlit scenes or extremely high-contrast scenes.
- When shooting subjects that are sufficiently bright, for example for normally lit scenes, the image may look unnatural because of the applied HDR effect.

Cautions for <P> and <A>

- Compared with other shooting modes, the shooting area will be smaller.
- RAW + L or RAW cannot be selected. With other shooting modes, if RAW + L or RAW is set, the picture will be recorded in L.
- If you shoot a moving subject, ghost-like images of the subject may result.
- The image alignment may not function properly with repetitive patterns (lattice, stripes, etc.), flat or single-tone images, or greatly misaligned shots caused by camera shake.
- Compared to normal shooting, recording the image to the card will take longer. During the processing of the images, [BUSY] will be displayed and you cannot take another picture until the processing is completed.
- You cannot use Creative filters when shooting.
- Final image simulation is not available.
- If the mode dial is set to <P> or <A>, direct printing is not possible. Select other mode and perform direct printing.

Quick Control for Basic Zone and Scene Intelligent Auto

Example: Portrait mode

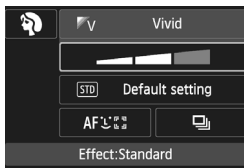

Quick Control Functions

















Q: Quick Control INFO.: INFO. Quick Control ●: Default setting

Function		(p.66)	(p.75)	(p.78)	(p.79)	(p.80)	(p.81)	(p.83)	(p.85)	(p.86)
Drive mode	: Single shooting	INFO. (●)	INFO. (●)	INFO.	INFO. (●)	INFO. (●)	INFO.	INFO. (●)	INFO. (●)	INFO. (●)
	: Continuous shooting (p.133)	INFO.	INFO.	INFO. (●)	INFO.	INFO.	INFO. (●)	INFO.	INFO.	INFO.
	Self-timer (p.136) 	INFO.	INFO.	INFO.	INFO.	INFO.	INFO.	INFO.	INFO.	INFO.
Speedlite 90EX	: Automatic firing	●	Q+ INFO. (●)	●	-	●	-	●	-	-
	: Flash on (Fires at all times)	-	Q+ INFO.	-	-	-	-	-	●	-
	: Flash off	-	Q+ INFO.	-	●	-	●	-	-	●
Ambience-based shots (p.89)		-	Q+ INFO.	Q+ INFO.	Q+ INFO.	Q+ INFO.	Q+ INFO.	Q+ INFO.	Q+ INFO.	-
Light/scene-based shots (p.92)		-	-	Q+ INFO.	Q+ INFO.	Q+ INFO.	Q+ INFO.	-	-	-
Blurring/sharpening the background (p.77)		-	Q+ INFO.	-	-	-	-	-	-	-
Creative filters		-	Q	Q	Q	Q	Q	Q	-	-
Image quality		Q	Q	Q	Q	Q	Q	Q	Q	Q
AF method	+Tracking FlexiZone - Multi FlexiZone - Single	Q+ INFO.	Q+ INFO.	Q+ INFO.	Q+ INFO.	Q+ INFO.	Q+ INFO.	Q+ INFO.	Q+ INFO.	Q+ INFO.

- If you change the shooting mode or set the power to <OFF>, it will revert to the default settings (except the AF method, image-recording quality, self-timer and remote control settings, and creative filter settings only with Creative Zone modes that allow their use).
- Creative filters can also be used in Creative Zone modes: **M**, **Av**, **Tv**, and **P**.





Shoot by Ambience Selection

Except in the <  > Basic Zone mode, you can select the ambience for shooting.

Ambience								Ambience Effect
 Standard setting	<input type="radio"/>	<input type="radio"/>	<input type="radio"/>	<input type="radio"/>	<input type="radio"/>	<input type="radio"/>	<input type="radio"/>	No setting
 Vivid	<input type="radio"/>	<input type="radio"/>	<input type="radio"/>	<input type="radio"/>	<input type="radio"/>	<input type="radio"/>	<input type="radio"/>	Low / Standard / Strong
 Soft	<input type="radio"/>	<input type="radio"/>	<input type="radio"/>	<input type="radio"/>	<input type="radio"/>	<input type="radio"/>	<input type="radio"/>	Low / Standard / Strong
 Warm	<input type="radio"/>	<input type="radio"/>	<input type="radio"/>	<input type="radio"/>	<input type="radio"/>	<input type="radio"/>	<input type="radio"/>	Low / Standard / Strong
 Intense	<input type="radio"/>	<input type="radio"/>	<input type="radio"/>	<input type="radio"/>	<input type="radio"/>	<input type="radio"/>	<input type="radio"/>	Low / Standard / Strong
 Cool	<input type="radio"/>	<input type="radio"/>	<input type="radio"/>	<input type="radio"/>	<input type="radio"/>	<input type="radio"/>	<input type="radio"/>	Low / Standard / Strong
 Brighter	<input type="radio"/>	<input type="radio"/>	<input type="radio"/>	<input type="radio"/>	<input type="radio"/>	<input type="radio"/>	<input type="radio"/>	Low / Medium / High
 Darker	<input type="radio"/>	<input type="radio"/>	<input type="radio"/>	<input type="radio"/>	<input type="radio"/>	<input type="radio"/>	<input type="radio"/>	Low / Medium / High
 Monochrome	<input type="radio"/>	<input type="radio"/>	<input type="radio"/>	<input type="radio"/>	<input type="radio"/>	<input type="radio"/>	<input type="radio"/>	Blue / B/W / Sepia

1 Select a Basic Zone mode except <  >.

2 On the Quick Control screen, select the desired ambience.

- Display the Quick Control screen.
- As shown in the illustration, tap on [ **Standard setting**] so that [**Ambience-based shots**] appears on the screen.
- Tap []/[] to select an ambience.
- ▶ With the  Quick Control screen, you can check the effect of the selected ambience on the LCD monitor.

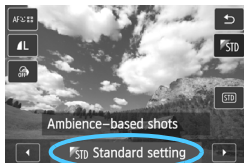



3 Set the ambience effect.

- Tap the item shown in the figure so that **[Effect]** appears on the bottom of the screen.
- Tap the effect's level and setting.

4 Take the picture.

- Press the shutter button.
- If you change the shooting mode or set the power to **<OFF>**, the setting will revert back to **[STD Standard setting]**.

- The LCD monitor image shown with the ambience setting applied will not look exactly the same as the actual photo.
- Using flash may minimize the ambience effect.
- In bright outdoors, the LCD monitor image you see may not have exactly the same brightness or ambience as the actual photo. Set **[F2: LCD brightness]** to 4 and look at the LCD monitor image while the screen is unaffected by stray light.

Ambience Settings

Standard setting

Standard settings for the respective shooting mode. Note that has image characteristics geared for portraits and is geared for landscapes. Each ambience is a modification of the respective shooting mode's image settings.

Vivid

Makes the image more vivid and impressive than with [ **Standard setting**].

Soft

Suited for portraits, pets, flowers, etc., when you want a soft look.

Warm

For portraits, pets, etc., when you want a warm-tone ambience.

Intense

The overall brightness is slightly suppressed while the subject is emphasized. Gives the human or living subject more presence.

Cool

The overall brightness is slightly suppressed while a cool-tone ambience is set. Makes a subject in the shade look more silent and impressive.

Brighter

The picture will look brighter.

Darker

The picture will look darker.

Monochrome

You can select the monochrome color to be black and white, sepia, or blue.

Shoot by Lighting or Scene Type

In the <📷>, <🏞️>, <🌸>, and <🌃> Basic Zone modes, you can shoot while the settings match the lighting or scene type. Normally, [STD] **Default setting**] is adequate, but if the settings match the lighting condition or scene, the picture will look more accurate to your eye.

Lighting or Scene	📷	🏞️	🌸	🌃
[STD] Default setting	<input type="radio"/>	<input type="radio"/>	<input type="radio"/>	<input type="radio"/>
☀️ Daylight	<input type="radio"/>	<input type="radio"/>	<input type="radio"/>	<input type="radio"/>
🏠 Shade	<input type="radio"/>	<input type="radio"/>	<input type="radio"/>	<input type="radio"/>
☁️ Cloudy	<input type="radio"/>	<input type="radio"/>	<input type="radio"/>	<input type="radio"/>
💡 Tungsten light	<input type="radio"/>	<input checked="" type="radio"/>	<input type="radio"/>	<input type="radio"/>
💡 Fluorescent light	<input type="radio"/>	<input checked="" type="radio"/>	<input type="radio"/>	<input type="radio"/>
🌅 Sunset	<input type="radio"/>	<input type="radio"/>	<input type="radio"/>	<input type="radio"/>

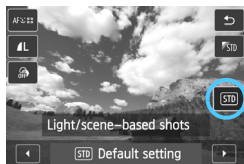

1 Select a Basic Zone mode: <📷> <🏞️> <🌸> <🌃>.

2 On the Quick Control screen, select the lighting or scene type.

- Display the Quick Control screen.
- As shown in the figure, tap on [STD] so that [Light/scene-based shots] appears on the screen.
- Tap [◀]/[▶] to select the lighting or scene type.
- ▶ With the  Quick Control screen, the LCD monitor will show how the image will look with the selected lighting or scene type.

3 Take the picture.

- Press the shutter button.
- If you change the shooting mode or set the power to <OFF>, the setting will revert back to [STD] **Default setting**].



- When using a flash, the setting will switch to [STD] **Default setting**. (However, the shooting information will display the lighting or scene type that was set.)
- If you want to set this together with [**Ambience-based shots**], set the [**Light/scene-based shots**] that best matches the ambience you have set. In the case of [**Sunset**] for example, warm colors will become prominent so the ambience you set may not work well.

Lighting or Scene Type Settings

Default setting

Default setting suited for most subjects.

Daylight

For subjects under sunlight. Gives more natural-looking blue skies and greenery and reproduces light-colored flowers better.

Shade

For subjects in the shade. Suitable for skin tones, which may look too bluish, and for light-colored flowers.

Cloudy

For subjects under overcast skies. Makes skin tones and landscapes, which may otherwise look dull on a cloudy day, look warmer. Also effective for light-colored flowers.

Tungsten light

For subjects under tungsten lighting. Reduces the reddish-orange color cast caused by tungsten lighting.

Fluorescent light

For subjects under fluorescent lighting. Suited for all types of fluorescent lighting.

Sunset

Suitable when you want to capture the sunset's impressive colors.

Using Creative Filters

Except in the Scene Intelligent Auto, Handheld Night Scene, HDR Backlight Control, and Movie shooting modes, you can apply a Creative filter and check the effect and composition. When you take the picture, only the image applied with the Creative filter will be saved. If you want to also save the image not applied with the Creative filter, use the Creative filter during image playback (p.260).

1 Select a shooting mode other than <A+>, <PA>, <S>, and Movie shooting.









2 With the  Quick Control screen, select a Creative filter.

- Tap [Creative filters].
- Tap the desired Creative filter. For details on Creative filter characteristics, see pages 96, 97.
- ▶ On the LCD monitor, you can see the effect of the Creative filter you selected.





3 Adjust the filter effect.



- You can adjust the effect except the Miniature effect. When you tap on a filter, the [] (except for Toy camera) or [] (Toy camera) indicator will appear. While checking the effect on the LCD monitor, tap [] or [].
- For the Miniature effect, tap [] to turn off the  Quick Control screen. A white frame will appear, indicating the area that you want to look sharp. While looking at the LCD monitor, drag the frame as desired.

- By tapping [], you can change the white frame's horizontal or vertical orientation.

4 Take the picture.

- Press the shutter button.

 When you use a Creative Filter and shoot, even if you set the drive mode to continuous shooting ( / ), single shooting will take effect.

- 
- A Creative filter cannot be applied if the image-recording quality is **RAW +  L** or **RAW**. A Creative filter also cannot be applied if AEB (Auto Exposure Bracketing) or WBB (White Balance Bracketing) is set or if **[High ISO speed NR]** is set to **[Multi Shot Noise Reduction]**.
 - When you use a Creative filter and shoot, the histogram will not be displayed.

Creative Filter Characteristics

-  **Grainy B/W**

Makes the image grainy and black and white. By adjusting the contrast, you can change the black-and-white effect.

-  **Soft focus**

Gives the image a soft look. By adjusting the blur, you can change the degree of softness.

-  **Fish-eye effect**

Gives the effect of a fish-eye lens. The image will have a barrel-type distortion.



Depending on the level of this filter effect, the area trimmed along the periphery of the image changes. Also, since this filter effect will magnify the image center, the apparent resolution at the center may degrade depending on the number of recorded pixels. Set the filter effect while checking the resulting image. With the fish-eye effect, the AF will be fixed at the center AF point.

-  **Art bold effect**

Makes the photo look like an oil painting and the subject look three-dimensional. You can adjust the contrast and saturation. Note that the sky, white walls, and similar subjects may not be rendered with a smooth gradation and may look irregular or have significant noise.

-  **Water painting effect**

Makes the photo look like a watercolor painting with soft colors. You can adjust the color density. Note that night scenes or dark scenes may not be rendered with a smooth gradation and may look irregular or have significant noise.

-  **Toy camera effect**
Gives a color cast typical of toy cameras and darkens the image's four corners. By adjusting the color tone, you can change the color cast.
-  **Miniature effect**
Creates a diorama effect. You can change where the image looks sharp. The camera will focus at the center of the white frame and the AF method will be fixed at [**FlexiZone - Single**].



- With [**Grainy B/W**], the grainy look of the image displayed on the screen may differ from that of the recorded image.
- With [**Soft focus**] and [**Toy camera effect**], the soft focus effect of the image displayed on the screen may differ from that of the recorded image. If you are using a shooting mode other than the Basic Zone modes or movie shooting, you can set the menu's Custom Function C.Fn-6 to [**Depth-of-field preview**] (p.287) and press the <▼  > button to check the soft focus of the image that will be recorded.

▶ Image Playback

The easiest way to play back images is explained below. For more details on the playback procedure, see page 229.

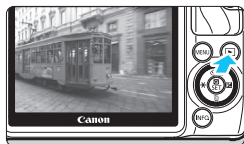

1 Play back the image.

- Press the <▶> button.
- ▶ The last captured image or last image viewed will appear.
- When the power is <OFF> and you hold down the <▶> button for 2 seconds or longer, the power will turn <ON> and the playback screen will appear.

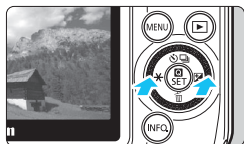

2 Select an image.

- When you press the <◀ * > button, the last image captured will be displayed first.
- When you press the <▶ □ > button, the first image captured will be displayed first.
- Each time you press the <INFO.> button, the information display will change.



No information



With basic information

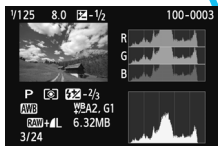

Histogram display

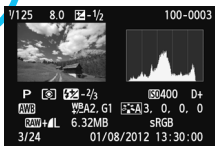

Shooting information

3 Exit the image playback.

- Press the <▶> button to exit the image playback and return to the Live View screen.





Experiment with your photography to create new and exciting images. As you progress try out new viewpoints and shoot from different angles.

Look for different facial expressions and poses in your portraits.

3

Creative Shooting

With Scene Intelligent Auto and Basic Zone modes, you can easily take pictures, but cannot change the function settings. With the <P> (Program AE), you can set various functions for more creative shooting.

- In the <P> mode, the camera sets the shutter speed and aperture automatically to obtain a standard exposure.
- The difference between the Basic Zone modes and <P> is explained on page 296.
- The functions explained in this chapter can also be used in the <Tv>, <Av>, and <M> modes explained in Chapter 4.
- The ☆ mark shown on the right of the page title indicates that the function is available only in Creative Zone modes (p.25).

* <P> stands for Program.

* AE stands for Auto Exposure.

P: Program AE

The camera automatically sets the shutter speed and aperture to suit the subject's brightness. This is called Program AE.

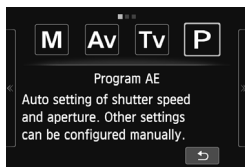

1 In the Creative Zone, select <P> (p.74).



2 Focus the subject.

- Aim the AF point over the subject. Then press the shutter button halfway.
- ▶ The AF point achieving focus will turn green (with One-Shot AF).
- ▶ The shutter speed and aperture will be set automatically and displayed.



3 Check the display.

- A standard exposure will be obtained as long as the shutter speed and aperture display do not blink.

4 Take the picture.

- Compose the shot and press the shutter button completely.



Shooting Tips

● Change the ISO speed. Use Speedlite 90EX.

To match the subject and ambient lighting level, you can change the ISO speed (p.109) or use Speedlite 90EX (p.138). In the <P> mode, the Speedlite 90EX does not fire automatically. In low-light conditions, turn <ON> the Speedlite 90EX and set [📷 1: External Speedlite control]'s [Flash firing] to [Enable].

● The program can be shifted. (Program shift)

After pressing the shutter button halfway, turn the <☉> dial to change the shutter speed and aperture setting combination (program). Program shift is canceled automatically after the picture is taken*. Program shift is not possible with flash.

* If the pointer icon <↖↗> is displayed above the exposure compensation display, press the <▶📷> button to turn off the pointer icon and then turn the <☉> dial.

● Check the depth of field.

In Creative Zones modes, if you use Custom Function C.Fn-6 to assign the <▼📷> button to [Depth-of-field preview], you can check the depth of field.



- If the “30” shutter speed and the maximum aperture blink, it indicates underexposure. Increase the ISO speed or use flash.
- If the “4000” shutter speed and the minimum aperture blink, it indicates overexposure. Decrease the ISO speed.





Differences Between <P> and <A+> (Scene Intelligent Auto)

In the <A+> mode, many functions such the AF operation, are set automatically. The functions you can change are limited. Whereas with the <P> mode, only the shutter speed and aperture are set automatically. You can freely set the AF operation and other functions (p.296).

Quick Control

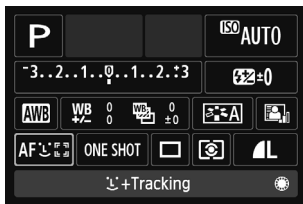
In Creative Zone modes, you can set the AF method, AF operation, Drive mode, Image quality, White balance, Creative filters, Picture Style, Auto Lighting Optimizer, Metering mode, etc.



 For details on metering modes, see page 151.

MENU Setting the Image-Recording Quality

You can select the pixel count and the image quality. Ten image-recording quality settings are provided: **L**, **L**, **M**, **M**, **S1**, **S1**, **S2**, **S3**, **RAW + L**, **RAW**.

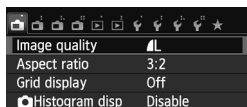

1 Select [Image quality].

- Under the [**1**] tab, select [Image quality], then press <**Q**/SET>.

Pixels recorded (pixel count)

Possible shots

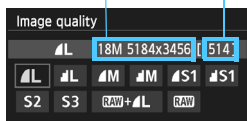

2 Select the image-recording quality.

- The respective quality's pixel count and number of possible shots will be displayed to help you select the desired quality. Then press <**Q**/SET>.

Guide to Image-recording Quality Settings (Approx.)

Image Quality		Pixels Recorded (megapixels)	File Size (MB)	Possible Shots	Maximum Burst	
L	High quality	JPEG	Approx. 17.9 (18M)	6.4	1140	15 (17)
			3.2	2240	2240 (2240)	
Approx. 8.0 (8M)	3.4		2150	2150 (2150)		
	1.7		4200	4200 (4200)		
S1	Low quality		Approx. 4.5 (4.5M)	2.2	3350	3350 (3350)
			1.1	6360	6360 (6360)	
S2	Approx. 2.5 (2.5M)	1.3	5570	5570 (5570)		
S3	Approx. 0.35 (0.35M)	0.3	21560	21560 (21560)		
RAW + L	High quality	Approx. 17.9 (18M)	23.5+6.4	230	3 (3)	
			23.5	290	6 (6)	

* Figures for the file size, number of possible shots, and maximum burst are based on Canon's 8 GB test card and testing standards (3:2 aspect ratio, ISO 100, and Standard Picture Style). **These figures will vary depending on the subject, card brand, aspect ratio, ISO speed, Picture Style, Custom Functions, and other settings.**

* Maximum burst figures in parentheses are based on Canon's UHS-I compatible, 8 GB test card.

? FAQ

- I want to select the image-recording quality matching the paper size for printing.

Paper size

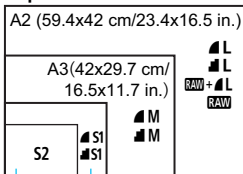

Refer to the diagram on the left when choosing the image-recording quality. If you want to crop the image, selecting a higher quality (more pixels) such as **L**, **L**, **RAW+L**, or **RAW** is recommended. **S2** is suitable for playing the images on a digital photo frame. **S3** is suitable for emailing the image or using it on a Web site.

12.7x8.9 cm/5.0x3.5 in.

- What's the difference between **L** and **L**?

It indicates a different image quality due to a different compression rate. Even with the same number of pixels, the **L** image has higher image quality. If **L** is selected, the image quality will be slightly lower, but more images can be saved to the card. Both **S2** and **S3** have **L** (Fine) quality.

- I was able to take more shots than the number of possible shots indicated.

The number of possible shots indicated is only approximate. Depending on the shooting conditions, you may be able to take more shots than was indicated. It may also be fewer than indicated.

- Does the camera display the maximum burst?

The maximum burst (1-9) is displayed to the right of the number of possible shots. (When the maximum burst is 10 or larger, it is not displayed.)

- When should I use **RAW**?

RAW images require processing with your computer. For details, see "About **RAW**" and "About **RAW+L**" on the next page.

About RAW

RAW is the raw image data before it is made into **L** or other images. Although **RAW** images require software such as Digital Photo Professional (provided, p.340) so that they can be displayed on the computer, they also offer flexibility for image adjustments possible only with **RAW**. **RAW** is effective when you want to precisely adjust the image yourself or shoot an important subject.

About RAW + L

RAW + **L** records both a **RAW** and **L** image with a single shot. The two images are saved to the card simultaneously. The two images will be saved in the same folder with the same file numbers (file extension .JPG for JPEG and .CR2 for RAW). **L** images can be viewed or printed even with a computer that does not have the software provided with the camera installed.

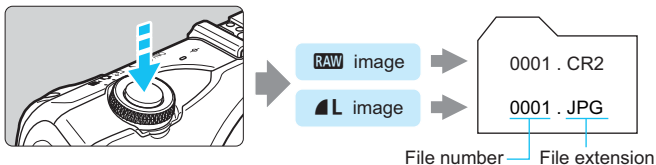

 Commercially-available software may not be able to display RAW images. Using the provided software is recommended.

● Aspect ratio

The image's aspect ratio can be set to [3:2], [4:3], [16:9], or [1:1]. The area surrounding the image on the LCD monitor is masked in black when the following aspect ratios are set: [4:3] [16:9] [1:1]. JPEG images will be saved with the set aspect ratio. RAW images will always be saved with the [3:2] aspect ratio. Since the aspect ratio information is appended to the RAW image, the image will be generated in the respective aspect ratio when you process the RAW image with the provided software. In the case of the [4:3], [16:9], and [1:1] aspect ratios, the aspect-ratio lines will appear during image playback, but the lines are not actually drawn on the image.

Image Quality	Aspect Ratio and Pixel Count			
	3:2	4:3	16:9	1:1
L RAW	5184x3456 (18.0 megapixels)	4608x3456 (16.0 megapixels)	5184x2912* (15.1 megapixels)	3456x3456 (11.9 megapixels)
M	3456x2304 (8.0 megapixels)	3072x2304 (7.0 megapixels)	3456x1944 (6.7 megapixels)	2304x2304 (5.3 megapixels)
S1	2592x1728 (4.5 megapixels)	2304x1728 (4.0 megapixels)	2592x1456* (3.8 megapixels)	1728x1728 (3.0 megapixels)
S2	1920x1280 (2.5 megapixels)	1696x1280* (2.2 megapixels)	1920x1080 (2.1 megapixels)	1280x1280 (1.6 megapixels)
S3	720x480 (350,000 pixels)	640x480 (310,000 pixels)	720x400* (290,000 pixels)	480x480 (230,000 pixels)

- Asterisked image-recording qualities do not exactly match the set aspect ratio.
- The image area displayed for the asterisked aspect ratio is slightly larger than the recorded area. Check the captured images on the LCD monitor when shooting.
- If you use a different camera to directly print images shot with this camera in the 1:1 aspect ratio, the images may not be correctly printed.

● Metering timer

You can change the length of time that the exposure value will be displayed (the exposure lock period when using AE lock).

In Basic Zone modes, and if FE locked is applied when an external flash is attached, the length of time will be fixed at 16 seconds.

MENU ISO: Changing the ISO Speed ☆

Set the ISO speed (image sensor's sensitivity to light) to suit the ambient light level. In Basic Zone modes, the ISO speed is set automatically (p.112).

You can set the ISO speed with the following: 1. ISO display on the Live View screen, 2. \blacktriangledown $\left[\begin{array}{c} \text{ISO} \\ \text{INFO} \end{array} \right]$ button assigned with the menu's Custom Function, 3. Menu screen, and 4. INFO. Quick Control screen.

Using the Live View screen's ISO Display



1 Select the ISO speed.

- Tap the ISO display on the LCD monitor's lower right.



2 Set the ISO speed.

- Tap the ISO display and select the desired ISO speed, then tap $\left[\begin{array}{c} \text{ISO} \\ \text{INFO} \end{array} \right]$.
- With [AUTO] selected, the ISO speed will be set automatically (p.112).

Assigning [ISO speed] to the \blacktriangledown $\left[\begin{array}{c} \text{ISO} \\ \text{INFO} \end{array} \right]$ Button with the Custom Function Menu

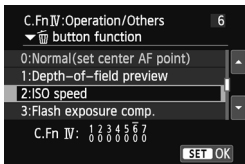

With C.Fn-6, you can assign the ISO speed setting to the \blacktriangledown $\left[\begin{array}{c} \text{ISO} \\ \text{INFO} \end{array} \right]$ button (p.287).

Using the Menu Screen

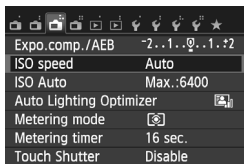

1 Select [ISO speed].

- Under the [3] tab, select [ISO speed], then press < >.

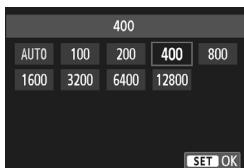

2 Set the ISO speed.

- Press the < * > / < > button to select the desired ISO speed, then press < >.
- With [AUTO] selected, the ISO speed will be set automatically (p.112).

Using the INFO. Quick Control Screen



1 Select the ISO speed.

- On the INFO. Quick Control screen, select the ISO display on the LCD monitor's upper right.

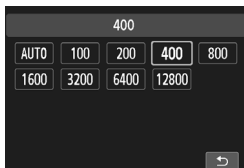

2 Set the ISO speed.

- Tap the ISO display and select the desired ISO speed, then tap [].
- With [AUTO] selected, the ISO speed will be set automatically (p.112).

ISO Speed Guide

ISO Speed	Shooting Situation (No flash)	Flash Range
100 - 400	Sunny outdoors	The higher the ISO speed, the farther the flash range will extend (p.139).
400 - 1600	Overcast skies or evening time	
1600 - 12800, H	Dark indoors or night	

* High ISO speeds will result in grainier images.



- Under [**4: Custom Functions (C.Fn)**], if [**2: ISO expansion**] is set to [**1: On**], "H" (equivalent to ISO 25600) can also be set (p.284).
- Even if a low ISO speed is set, noise may be noticeable in the LCD monitor image under low light. However, when you shoot, the image recorded will have minimal noise. (The image quality of the LCD monitor image is different from that of the recorded image.)



- Under [**4: Custom Functions (C.Fn)**], if [**3: Highlight tone priority**] is set to [**1: Enable**], ISO 100 and "H" (equivalent to ISO 25600) cannot be selected (p.285).
- Shooting in high temperatures may result in images that look grainier. Long exposures can also cause irregular colors in the image.
- When you shoot at high ISO speeds, noise (such as dots of light and banding) may become noticeable.
- If you use a high ISO speed and flash to shoot a close subject, overexposure may result.
- With ISO 12800 or "H" (equivalent to ISO 25600), the number of possible shots/maximum burst for continuous shooting will greatly decrease.
- As "H" (equivalent to ISO 25600) is an expanded ISO speed setting, noise (such as dots of light and banding) and irregular colors will be more noticeable, and the resolution will be lower than usual.
- As the maximum ISO speed that can be set differs between still photo shooting and movie shooting (manual exposure), the ISO speed you set may change when you switch from still photo shooting to movie shooting. Even if you switch back to still photo shooting, the ISO speed will not revert to the original setting. The maximum ISO speed that can be set varies depending on the setting for [**2: ISO expansion**] under [**4: Custom Functions (C.Fn)**].
 - When [**0: Off**] is set: If you set ISO 12800 during still photo shooting and then switch to movie shooting, ISO speed will be changed to ISO 6400.
 - When [**1: On**] is set: If you set ISO 12800/H (equivalent to ISO 25600) during still photo shooting and then switch to movie shooting, ISO speed will be changed to "H" (equivalent to ISO 12800).

ISO [AUTO]

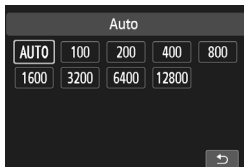

If the ISO speed is set to **[AUTO]** and you press the shutter button halfway, the current ISO speed will be displayed. As indicated below, the ISO speed will be set automatically to suit the shooting mode.

Shooting Mode	ISO Speed Setting
/	Automatically set within ISO 100 - 6400
	Automatically set within ISO 100 - 12800
P/Tv/Av/M *1	Automatically set within ISO 100 - 6400*2
With flash	ISO 400*3*4*5

*1: Fixed at ISO 400 for bulb exposures.

*2: Depends on the maximum ISO speed limit set.

*3: If fill-in flash results in overexposure, ISO 100 or a higher ISO speed will be set (except in **<M>** mode).

*4: Except in the , , and modes.

*5: Automatically set within ISO 400 - 1600 (or up to the maximum limit) in the , , , , and **<P>** modes if you use bounce flash with an external Speedlite.

When **[AUTO]** is set, the ISO speed is indicated in whole-stop increments. However, the ISO speed is actually set in finer increments. Therefore, in the image's shooting information (p.256), you may find an ISO speed such as 125 or 640 displayed as the ISO speed.

MENU Setting the Maximum ISO Speed for [ISO Auto]☆

For ISO Auto, you can set the maximum ISO speed limit within ISO 400 - 6400.

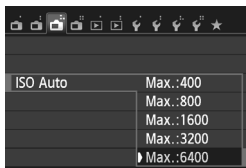

Under the [3] tab, select [ISO Auto], then press <Q/SET>. Select the ISO speed, then press <Q/SET>.

Selecting the Best Picture Style for the Subject ☆

Six Picture Styles are provided to suit your photographic expression or subject. Each one can be fine-tuned.

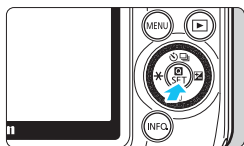

1 Display the Quick Control screen.

- ▶ With the  Quick Control screen, you can check the effect while setting the Picture Style.



2 Tap [A].

3 Tap a Picture Style to select it.

- To fine-tune the Picture Style, press the <INFO.> button.

Available Picture Styles

Auto

The color tone will be adjusted automatically to suit the scene.

The colors will look vivid, especially for blue skies, greenery, and sunsets in nature, outdoor, and sunset scenes.

 If the desired color tone is not obtained with [**Auto**], use another Picture Style.

Standard

The image looks vivid, sharp, and crisp. This is a general-purpose Picture Style suitable for most scenes.



Portrait

For nice skin tones. The image looks softer. Suited for close-up portraits.

By changing the [**Color tone**] (p.168), you can adjust the skin tone.



Landscape

For vivid blues and greens, and very sharp and crisp images. Effective for impressive landscapes.



Neutral

This Picture Style is for users who prefer to process images with their computer. Natural color tones and a subdued look.



Faithful

This Picture Style is for users who prefer to process images with their computer. When the subject is captured under a color temperature of 5200K, the color is adjusted colorimetrically to match the subject's color. Vivid colors are suppressed for a subdued look.



Monochrome

Creates black-and-white images.



Black-and-white images shot in formats other than **RAW** cannot be reverted to color. If you want to later shoot pictures in color, make sure the [**Monochrome**] setting has been canceled.



User Def. 1-3

You can register a basic style such as [**Portrait**], [**Landscape**], a Picture Style file, etc., and adjust it as desired (p.170). If no Picture Style is registered, the setting will be the same as the [**Auto**] default settings.

Changing the Focusing Method

		Scene Intelligent Auto	Basic Zone modes, Creative Zone modes
Focus mode*	Menu	(AF only)	AF, MF, AF+MF
AF method	Menu, Quick Control	L+Tracking, FlexiZone - Multi, FlexiZone - Single	
Continuous AF	Menu	Enable / Disable	

* "Focus mode" will be displayed when an EF-M lens has been attached.

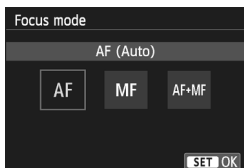

1 Select the AF method.

- Under the [CAMERA 2] tab, select [Focus mode], [AF method], or [Continuous AF].
- Select the item to be set, then press <Q/SET>.
- You can also select the [AF method] on the Quick Control screen.

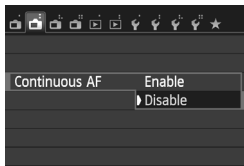
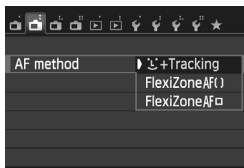

With an EF-M lens (operated with a menu):

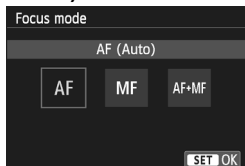

With an EF or EF-S lens (operated with a switch):

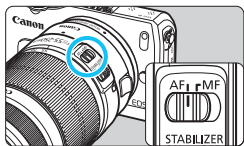

2 Set the lens focus mode to [AF].

- Under the [2] tab, select [Focus mode].
 - Select [AF].
 - ▶ For [**Focus mode**], if you select [**AF+MF**], you can hold the shutter button pressed halfway after the AF operation and focus manually (MF) with the focusing ring.
-
- Set the lens focus mode switch to <AF>.

☺ (face)+Tracking: AF☺

Human faces are detected and focused. If a face moves, the AF point <☺> also moves to track the face.



1 Check the AF point.

- When a face is detected, the <☺> AF point will appear over the face to be focused.
- You can also tap the screen to select the face or subject. If the subject is not a face, <☺> will be displayed.
- If no faces are detected or if you tap the screen but do not select any face or subject, the camera will switch to **[FlexiZone - Multi]** for automatic selection (p.120).

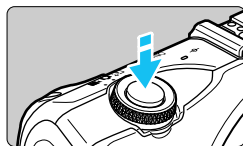

2 Focus the subject.

- Press the shutter button halfway to focus.
- ▶ When focus is achieved, the AF point will turn green and the beeper will sound. (If **[AF operation]** has been set to **[Servo AF]**, the AF point remains white and the beeper will not sound.)
- ▶ If focus is not achieved, the AF point will turn orange.



3 Take the picture.

- Press the shutter button completely (p.67).



- If the focus is far off, face detection will not be possible. If you set [**Continuous AF**] to [**Enable**], you can prevent the image from becoming greatly out of focus.
- An object other than a human face may be detected as a face.
- Face detection will not work if the face is very small or large in the picture, too bright or too dark, or partially hidden.
- The <[]> may cover only part of the face.



- When you press the <[]> button, the <[]> AF point will appear at the center of the screen. Drag it to move the AF point. Press the <[]> button again, and the AF point will move to the detected subject.
- Since AF is not possible with a face detected near the edge of the picture, the <[]> will be grayed out. If you press the shutter button halfway, the subject will be focused in FlexiZone - Multi method with automatic selection.

FlexiZone - Multi: AF ()

Up to 31 AF points (automatically selected) covering a wide area can be used to focus. This wide area can also be divided into 9 zones for focusing (zone selection).



1 Select the AF zone. ☆

- Pressing the <▼ [AF-ON]> button will toggle between automatic selection and zone selection. In Basic Zone modes, automatic selection will be set.
- To select a zone, tap it on the screen. To return to the center zone, press the <▼ [AF-ON]> button.
- During zone selection, tap the [] icon on the screen to switch to automatic selection.

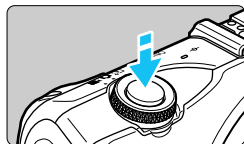

2 Focus the subject.

- Aim the AF point over the subject and press the shutter button halfway.
 - ▶ When focus is achieved, the AF point turns green and the beeper sounds. (If [AF operation] has been set to [Servo AF], the AF point remains white and the beeper will not sound.)
 - ▶ If focus is not achieved, the AF point will turn orange.



3 Take the picture.

- Press the shutter button completely (p.67).



- When the camera does not focus the desired target subject with automatic AF point selection, switch the AF method to zone selection or **[FlexiZone - Single]**, and refocus.
- Depending on the aspect ratio setting, the number of AF points will differ. At **[3:2]**, there will be 31 AF points. At **[1:1]** and **[4:3]**, there will be 25 AF points. And at **[16:9]**, 21 AF points. Also, at **[16:9]**, there will be only three zones.
- For movie shooting, there will be 21 AF points (or 25 AF points if **[640x480]** is set) and three zones (or 9 zones if **[640x480]** is set).

FlexiZone - Single: AF □

Since only one AF point is used to focus, you can focus the target subject.



AF point

1 Move the AF point.

- Tap the screen where you want to focus to move the AF point. (It cannot go to the edges of the picture.) To return the AF point to the center, press the **<▼>** button.

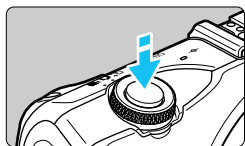

2 Focus the subject.

- Aim the AF point over the subject and press the shutter button halfway.
- ▶ When focus is achieved, the AF point turns green and the beeper sounds. (If **[AF operation]** has been set to **[Servo AF]**, the AF point remains white and the beeper will not sound.)
- ▶ If focus is not achieved, the AF point will change to orange.



3 Take the picture.

- Press the shutter button completely (p.67).

Notes About [AF+Tracking], [FlexiZone - Multi], and [FlexiZone - Single]

AF Operation

- Even when focus has been achieved, pressing the shutter button halfway will focus again.
- The image brightness may change during and after the AF operation.
- If the light source changes during autofocusing, the screen may flicker and focusing may be difficult. If this happens, autofocus under the light to be used for shooting.
- When [FlexiZone - Multi] is set and you tap on [Q] on the screen, the center of the zone (or screen center if automatic selection is set) will be magnified. If you press the shutter button halfway, the display will return to normal and the camera will focus.
- When [FlexiZone - Single] is set and you tap on [Q] on the screen, the image at the AF point will be magnified. When you press the shutter button halfway, the camera will focus while the magnified image is displayed (however, if [AF operation] is set to [Servo AF], the display will return to normal and then the camera will focus). This is effective when the camera is attached to a tripod and you need to attain very precise focus. If focusing is difficult in the magnified view, return to the normal display and use AF. Note that the AF speed may differ between the normal and magnified views.
- If you magnify the view after focusing with [FlexiZone - Multi] or [FlexiZone - Single] in the normal view, it may not look focused.
- If [AF+Tracking] is set, magnified view is not possible.

About continuous shooting when [AF operation] is set to [Servo AF]:

- When [AF+Tracking] or [FlexiZone - Multi] is set, when you press the shutter button halfway, the camera will focus and the AF point will be fixed.
- When an EF-M lens is used, Servo AF will be used to focus; if an EF or EF-S lens is used, focus lock will be used instead.



- If you shoot a peripheral subject and it is slightly out of focus, aim the center AF point or zone over the subject to focus, focus again and then take the picture.
- When [FlexiZone - Multi] is set and AF is used to focus, depending on the shooting conditions, it may take longer to focus the subject.
- In magnified view, focusing using AF may be difficult due to the magnified effect of camera shake. Using a tripod is recommended.

Shooting conditions that make focusing difficult

- Low-contrast subjects such as the blue sky, solid-color flat surfaces or when highlights or shadow details are lost.
- Extremely bright or dark subjects.
- Stripes and other patterns where there is contrast only in the horizontal direction.
- Subjects with repetitive patterns (skyscraper windows, computer keyboards, etc.).
- Fine lines and subject outlines.
- Under a light source whose brightness, color, or pattern keeps changing.
- Night scenes or points of light.
- When the image flickers under fluorescent or LED light sources.
- Extremely small subjects.
- Subjects at the edge of the picture.
- Subjects strongly reflecting light.
- The AF point covers both a near and faraway subject (such as an animal in a cage).
- Subjects that keep moving within the AF point and cannot keep still due to camera shake or subject blur.
- Autofocusing while the subject is very far out of focus.
- Soft focus effect is applied with a soft focus lens.
- A special effect filter is used.



- In the above cases, if the camera cannot focus automatically, focus manually.
- With some EF lenses (Mount Adapter EF-EOS M required), it may take longer to achieve focus or correct focus may not be achieved. For the latest information, visit your local Canon Web site.

Using Continuous AF

The default setting is **[Enable]**.

Since the focus is constantly close to the subject, when you press the shutter button, the camera quickly focuses the subject. If **[Enable]** is set, the lens will operate frequently and consume more battery power. This will reduce the number of possible shots (battery life).

When an EF or EF-S lens is used, during Continuous AF, turn off the power before setting the lens's focus mode switch to **<MF>**.

Using AF+MF Mode (Full-time manual focusing)

Set the Focus mode to **[AF+MF]**.

After focus is achieved using AF, you can adjust the focus manually as desired using the focusing ring while holding the shutter button pressed halfway.





However, in **<A>** mode (p.81) or if **[AF operation]** is set to **[Servo AF]** (p.131), priority is given to Servo AF. In such cases, even if you set the focus mode to **[AF+MF]**, you will not be able to focus manually.

Shooting with the Touch Shutter

You can focus and take the picture automatically just by tapping the LCD monitor screen. This works in all shooting modes.



1 Enable the touch shutter.

- Tap [] on the screen's bottom left. Each time you tap the icon, it will toggle between [] and [].
- When [] is set, you can tap to focus and shoot.

When [] is set, you can tap to select the point to focus. Then, press the shutter button completely to shoot.



2 Tap the screen to shoot.

- Tap the face or subject on the screen.
- ▶ At the point you tap, the camera will focus in the AF method that was set (p.118-121). When [**FlexiZone - Multi**] is set, it will switch to [**FlexiZone - Single**].
- ▶ When focus is achieved, the picture is taken automatically.
- The picture is not taken if focus is not achieved. Tap the face or subject on the screen again.



- Even if the drive mode is set to < > (continuous shooting), single shooting will take effect.
- The touch shutter does not function when the view is magnified.
- When [**1: AE lock/AF**] or [**3: AE/AF, no AE lock**] is set to [**5: Shutter/AE lock button**] under [**4: Custom Functions (C.Fn)**], autofocusing does not take effect.



- You can also enable the touch shutter by setting [**Touch Shutter: Enable**] under the [**3**] tab.
- To take a bulb exposure, tap the screen twice. The first tap on the screen will start the bulb exposure. Tapping it again will stop the exposure. Be careful not to shake the camera when tapping the screen.
- Even if [**AF operation**] is set to [**Servo AF**], One-Shot AF will take effect when touch shutter is used.

MF: Focus Manually

You can magnify the image and focus precisely with manual focus.

With an EF-M lens (operated with a menu):

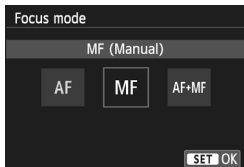

1 Set the lens focus mode to [MF].

- Under the [📷2] tab, select [Focus mode].
- Select [MF].

With an EF or EF-S lens (operated with a switch):

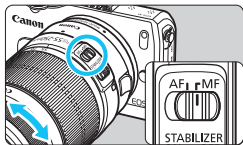

- Set the lens focus mode switch to <MF>.



2 Display the magnifying frame.

- Tap the [Q] icon.
- ▶ The magnifying frame will appear.
- Drag the magnifying frame over the screen to select the approximate area to magnify. To return to the screen's center, press the <▼🗑> button.



3 Select the area to magnify.

- Tap the four [▲] marks to select the area you want to magnify.
- To return to the screen's center, press the <▼🗑> button.

4 Magnify the image.

- Each time you tap on [Q] on the screen, the magnified area will change as follows:

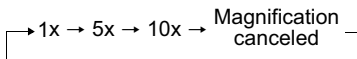

AE lock

Magnified area position

Magnification

5 Focus manually.

- While looking at the magnified image, turn the lens focusing ring to focus.
- After achieving focus, tap [Q] on the screen to return to the normal view.

6 Take the picture.

- Press the shutter button completely (p.67).









Focusing may be difficult in the magnified view due to the magnified effect of camera shake. Using a tripod is recommended.

When shooting, note the following:

Image Quality

- When you shoot at high ISO speeds, noise (such as dots of light and banding) may become noticeable.
- Shooting in high temperatures may cause noise and irregular colors in the image.
- If you shoot continuously for a long period, the camera's internal temperature may rise, and image quality may deteriorate. When you are not shooting, turn off the camera.
- If you shoot a long exposure while the camera's internal temperature is high, image quality may deteriorate. Stop shooting and wait a few minutes before shooting again.

Internal Temperature Warning (in white) or (in red)

- After prolonged shooting or when shooting under a high ambient temperature, the camera's internal temperature will increase and the white  icon or red  icon will appear in white or red on the screen.
- The white  icon indicates degraded still photo quality. It is recommended to temporarily stop shooting still photos until the camera's internal temperature decreases.
- The red  icon indicates that the power will soon turn off automatically. If this happens, you will not be able to shoot again until the camera's internal temperature decreases. Turn off the power and let the camera rest for a while.
- Shooting for prolonged periods under high ambient temperatures will cause the  icon or  icon to appear earlier. When you are not shooting, turn off the camera.
- Shooting high ISO speed images or long exposures while the camera's internal temperature is high, may result in degraded image quality even if the white  icon does not appear on the screen.

Shooting Result

- If you take the picture in magnified view, the exposure may not come out as desired. Return to the normal view before taking the picture. (During the magnified view, the shutter speed and aperture turn orange.) Even if you take the picture in magnified view, the image will be captured in the normal view.
- If [ **3: Auto Lighting Optimizer**] (p.159) is not set to [**Disable**], the image may look bright even if a decreased exposure compensation or decreased flash exposure compensation is set.
- If you use a TS-E lens (other than the TS-E 17mm f/4L or TS-E 24mm f/3.5L II) and shift or tilt the lens or use an Extension Tube, the standard exposure may not be obtained or an irregular exposure may result.



When shooting, note the following:

Image on the LCD monitor

- Under low- or bright-light conditions, the Live View image may not reflect the brightness of the captured image.
- If the light source within the image changes, the screen may flicker. If this happens, stop shooting and resume shooting under the actual light source.
- If you point the camera in a different direction, the image brightness may change greatly momentarily. Wait until the brightness level stabilizes before shooting.
- If there is a very bright light source in the picture, the bright area may appear black on the LCD monitor. In still photos, such bright areas will be recorded properly as a bright area. In movies, the bright areas will be recorded in almost the same way you see it on the LCD monitor.
- In low-light conditions, if you set [**F2: LCD brightness**] to a brighter setting, the image on the LCD monitor may develop chrominance noise. However, this chrominance noise will not be recorded in the image.
- When you magnify the image, the image sharpness may look more pronounced than in the actual image.

Lens and Flash

- The focus preset feature of some lenses cannot be used with this camera.
- Firing a modeling flash is not possible with the camera.

AF: Changing the Autofocus Operation ☆

In the <M>, <Av>, <Tv>, and <P> shooting modes, you can select the AF (Autofocus) operation to suit the shooting condition or subject. In Basic Zone modes, the optimum AF operation is set for the respective shooting mode.

1 Use the menu or focus mode switch to set the focus to <AF>.

2 On the Quick Control screen, tap the AF operation button.



3 Tap the AF operation.



4 Focus the subject.

- Aim the AF point over the subject and press the shutter button halfway. The camera will then autofocus with the selected AF operation.

 If focus cannot be achieved, the AF point will turn orange. If this occurs, the picture cannot be taken even if the shutter button is pressed completely. Recompose the picture and try to focus again. Or see “Shooting conditions that make focusing difficult” (p.123).

One-Shot AF for Still Subjects

Suited for still subjects. When you press the shutter button halfway, the camera will focus only once.

- When focus is achieved, the AF point will turn green and the beeper will sound.
- With evaluative metering (p.151), the exposure setting will be set at the same time focus is achieved.
- While you hold down the shutter button halfway, the focus will be locked. You can then recompose the shot if desired.



If [**3: Beep**] is set to [**Disable**], the beeper will not sound when focus is achieved.

Servo AF for Moving Subjects

This AF operation is suited for focusing moving subjects. When you first press the shutter button halfway, the camera will focus and the AF point will be fixed. While you hold down the shutter button halfway, the camera will keep focusing the subject.



- The exposure is set at the moment the picture is taken.
- During continuous shooting, the AF operation for shots after the first one is as follows.
 - When an EF-M lens is attached: the camera will continuously focus the subject.
 - When an EF or EF-S lens is attached: Focus lock will be used.
- When an EF or EF-S lens is attached, setting the [**AF method**] to [**FlexiZone - Single**] is recommended.
- Depending on the shooting conditions, it may take a moment until the shutter is released.

- Depending on the lens used, the distance to the subject and the subject's speed, the camera may not be able to achieve correct focus.
- During continuous shooting, the image displayed on the LCD monitor may seem out of focus.
- If you operate the zoom during continuous shooting, the focus may be lost. Use continuous shooting after using the zoom to obtain the desired composition.

 With Servo AF, the beeper will not sound even when focus is achieved.

AF-Assist Beam

Under low-light conditions, when you press the shutter button halfway, the self-timer/AF-assist beam may be emitted. It illuminates the subject to enable easier autofocusing.

- 
- When you hold the camera, be sure not to obstruct the self-timer lamp/AF-assist beam (p.48).
 - In < > mode, the self-timer/AF-assist beam does not emit the AF-assist beam.
 - The AF-assist beam will not be emitted with Servo AF operation.
 - In Creative Zone modes, the AF-assist beam will be emitted when necessary.
 - In movie shooting mode, the AF-assist beam is not emitted.
 - The AF-assist beam makes it easier to focus at the center of the screen.
 - Depending on the lens attached, the AF-assist beam may be obstructed and the camera may not be able to focus automatically.
 - You can enable or disable the AF-assist beam with the **[4: AF-assist beam (LED) firing]** setting under **[4: Custom Functions (C.Fn)]**.
 - When using an external flash, the AF-assist beam of the flash will not be emitted. However, if you use an EX-series Speedlite (sold separately) equipped with an LED light, when **[AF operation]** is set to **[ONE SHOT]**, the LED light will turn on for AF-assist if necessary.

Continuous Shooting

You can shoot up to approx. 4.3 shots per second (p.134).

This is effective for shooting a child walking toward you or capturing different facial expressions.

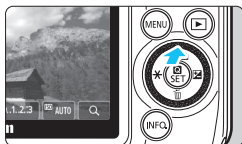

1 Press the <▲ / > button.

- You can also select the shooting mode on the INFO. Quick Control screen.



2 Tap [].

- By tapping [], you can return to the previous screen.

3 Take the picture.

- The camera shoots continuously while you hold down the shutter button completely.



Shooting Tips

- **Also set the AF operation** (p.130) **matching the subject.**
 - **For a moving subject**
When an EF-M lens is being used and **[Servo AF]** and **[AF method]** are both set, focusing on a moving subject will be continuous during continuous shooting.
 - **For still subjects**
When One-Shot AF is set, the camera will focus only once during continuous shooting.
- The continuous shooting speed (maximum number of frames per second) depends on the AF operation settings and the lens used.

AF operation	
One-Shot AF	Servo AF
approx. 4.3 fps	EF-M 18-55mm f/3.5-5.6 IS STM: approx. 1.7 fps
	EF-M 22mm f/2 STM: approx. 1.2 fps
	EF and EF-S lenses: approx. 4.3 fps

* During continuous shooting, the AF operation for shots after the first one is as follows.

- When an EF-M lens is attached: the camera will continuously focus the subject.
 - When an EF or EF-S lens is attached: Focus lock will be used.
- The continuous shooting speed may decrease when shooting subjects whose brightness changes considerably.
 - Depending on the lens used, the image displayed on the LCD monitor may appear darker during continuous shooting. However, the images will be recorded with the correct exposure.
 - When the ISO speed is set to ISO 12800 or higher, the LCD monitor brightness can be adjusted only from “1” to “4”.

- **Flash can also be used (with Speedlite 90EX attached).**

Since the flash will require recycling time, the continuous shooting speed will be slower.



- When the battery level is low, the continuous shooting speed will become slightly slower.
- The continuous shooting speed may become slower depending on the lens type, shutter speed, aperture, subject conditions, brightness, flash use, etc.
- When you use a Creative Filter and shoot, even if you set the drive mode to (continuous shooting), single shooting will take effect.

Using the Self-timer

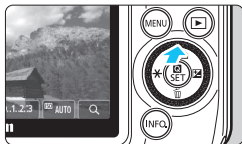

1 Press the <▲ [Self-timer] > button.

- You can also select the shooting mode on the INFO. Quick Control screen.



2 Tap the self-timer.

- By tapping [↶], you can return to the previous screen.

[Self-timer] icon: 10-sec. self-timer

The remote controller can also be used (p.291).

[Self-timer] 2 icon: 2-sec. self-timer

[Self-timer] c icon: 10-sec. self-timer plus continuous shots

Tap [▲]/[▼] to set the number of multiple shots (2 to 10) to be taken with the self-timer.

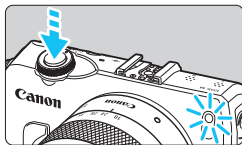

3 Take the picture.

- Focus the subject, then press the shutter button completely.
- ▶ You can check the self-timer operation with the self-timer/AF-assist beam, beeper, and countdown display (in seconds) on the LCD monitor.
- ▶ Two seconds before the picture is taken, the self-timer/AF-assist beam will light up and the beeper will sound faster.

To cancel the self-timer shooting:

Press the <▲ [Self-timer] > button or set the power to <OFF>.

(To cancel the self-timer setting, press the <▲ [Self-timer] > button and tap [□] or [Self-timer].)



- With , the interval between the multiple shots may be prolonged depending on the shooting functions settings such as the image-recording quality or flash.
- When you use a Creative Filter and shoot, even if you set the drive mode to (Self-timer: Continuous), single shooting will take effect.



- After taking self-timer shots, playing back the image (p.98) to check focus and exposure is recommended.
- When using the self-timer to shoot only yourself, use focus lock (p.71) on an object at about the same distance as where you will stand.

⚡ Using a Flash

In indoors, low light, or backlit conditions in daylight, you can attach a flash unit and just press the shutter button to take nice pictures. In the <P> mode, the shutter speed (1/60 sec. - 1/200 sec.) will be set automatically to obtain correct exposure of the subject.

In this section, the use of flash functions is explained using a Speedlite 90EX. For details about using other EOS-dedicated, EX-series Speedlite flashes, see page 292. For details on the Speedlite 90EX, see the Speedlite 90EX Instruction Manual. (When the Speedlite 90EX is attached to this camera, its AF-assist beam will not light up.)

Fully Automatic Flash Shooting

When the shooting mode is <A+> (Scene Intelligent Auto), <P> (Portrait), <M> (Close-up) or <N> (Night Portrait), fully automatic flash shooting is possible. When the shooting mode is <CA> (Creative Auto), you can select [Auto flash], [Flash on] or [Flash off] from the Quick Control screen*.

* The flash mode will differ depending on the shooting mode.

Shooting Mode	Flash mode
A+ (Scene Intelligent Auto)	Auto flash
CA (Creative Auto)	Auto Flash/Flash on/Flash off*
P (Portrait)	Auto flash
M (Landscape)	Flash off
M (Close-up)	Auto flash
S (Sports)	Flash off
N (Night Portrait)	Auto flash
H (Handheld Night Scene)	Flash on
L (HDR Backlight Control)	Flash off
P (Program AE)	Flash on
Tv	Flash on
Av	Flash on
M	Flash on
Movies	Flash off

* Flash mode can be set from the Quick Control screen.

 If the resulting picture is too dark, get closer to the subject and take the picture again.

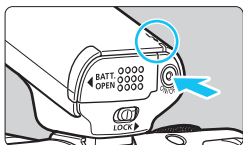

1 Attach a Speedlite and turn on the Speedlite.

- ▶ The Speedlite's power lamp will light and recharging will start.

2 Check that the <⚡> lamp lights.

- When it lights, you can shoot.
- In Basic Zone modes (p.26), you will not be able to release the shutter until the <⚡> lamp lights.



3 Press the shutter button halfway.

- On the bottom left of the LCD monitor, check that the <⚡> icon is displayed.

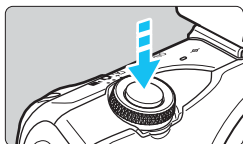

4 Take the picture.

- When focus is achieved and you press the shutter button completely, the flash will fire for the picture.

Effective Flash Range

[Approx. in meters/feet]

ISO speed	EF-M 18-55mm f/3.5-5.6 IS STM		EF-M 22mm f/2 STM
	18mm (f/3.5)	55mm (f/5.6)	22mm (f/2.0)
100	1 - 2.6 / 3.3 - 8.5	1 - 1.6 / 3.3 - 5.2	1 - 4.5 / 3.3 - 14.8
200	1 - 3.6 / 3.3 - 11.8	1 - 2.3 / 3.3 - 7.5	1 - 6.4 / 3.3 - 21.0
400	1 - 5.1 / 3.3 - 16.7	1 - 3.2 / 3.3 - 10.5	1 - 9.0 / 3.3 - 29.5
800	1 - 7.3 / 3.3 - 23.9	1 - 4.5 / 3.3 - 14.8	1.1 - 12.7 / 3.6 - 41.7
1600	1 - 10.3 / 3.3 - 33.8	1 - 6.4 / 3.3 - 21.0	1.6 - 18.0 / 5.2 - 59.0
3200	1.3 - 14.5 / 4.3 - 47.6	1 - 9.1 / 3.3 - 29.8	2.3 - 25.5 / 7.5 - 83.6
6400	1.8 - 20.6 / 5.9 - 67.6	1.1 - 12.9 / 3.6 - 42.3	3.2 - 36.0 / 10.5 - 118
12800	2.6 - 29.1 / 8.5 - 95.4	1.6 - 18.2 / 5.2 - 59.7	4.5 - 50.9 / 14.8 - 167

Camera-Linked Flash Power Off Function

When you turn the camera <OFF> after having shot with a Speedlite 90EX attached to the camera, the Speedlite's power will also be turned <OFF>. However, depending on the operation, the Speedlite's power off may not be correctly linked to the camera's power off.



Shooting Tips

- **If the resulting picture is too dark.**

In Creative Zone modes: **M**, **Av**, **Tv** or **P**, get closer to the subject or increase the ISO speed. By increasing the ISO speed, you can extend the flash range.

In other shooting modes, get closer to the subject and take the picture again.

- **Using fill-in flash**

To take pictures of backlit subjects, select [**Evaluative**] for [**E-TTL II meter.**] (p.220). Using the fill-in flash function, you can have the subject's face appear brighter.

- **In bright light, decrease the ISO speed. (M, Av, Tv or P mode)**

If the exposure setting on the LCD monitor blinks, decrease the ISO speed.

- **Detach the lens hood and keep at least 1 meter/3.3 feet away from the subject.**

If the lens has a hood attached or you are too close to the subject, the bottom of the picture may look dark due to the obstructed flash. For important shots, check the image on the LCD monitor to make sure the flash exposure looks natural (not dark at the bottom).

 When using the Mount Adapter EF-EOS M, the light of the flash may be partially obstructed, casting a shadow on the bottom part of the picture.



Interchangeable-lens cameras, like the EOS M, offer tremendous flexibility. A telephoto lens brings far-off objects closer and compresses perspective; wide angle lenses do the opposite and allow dramatic viewpoints.

4

Advanced Shooting

This chapter builds on Chapter 3 and introduces more ways to shoot creatively.

- The first half of this chapter explains how to use the <Tv>, <Av>, and <M> modes.
- All the functions explained in Chapter 3 can also be used in the <Tv>, <Av>, and <M> modes.
- To see which functions can be used in each shooting mode, see page 296.
- The ☆ mark shown on the right of the page title indicates that the function is available only in Creative Zone modes (p.25).

About the Main Dial Pointer

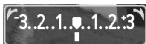

The pointer icon <👉> displayed together with the shutter speed, aperture setting, or exposure compensation amount indicates that you can turn the <🌀> dial to adjust the respective setting.

Tv: Convey the Subject's Movement

You can either freeze the action or create motion blur with the <Tv> (Shutter-priority AE) mode.

* <Tv> stands for Time value.



Blurred motion
(Slow shutter speed: 1/30 sec.)



Frozen action
(Fast shutter speed: 1/2000 sec.)



1 Tap the shooting mode icon on the screen's upper left corner.

- The shooting mode selection screen will appear.

2 Tap [Tv] on the screen.



3 Set the desired shutter speed.

- See "Shooting Tips" for advice on setting the shutter speed.
- When you tap the shutter speed, the setting screen will appear. Tap [◀]/[▶] or turn the <⦿> dial to set the shutter speed.
- Turning the <⦿> dial to the right sets a faster shutter speed, and turning it to the left sets a slower one.



4 Take the picture.



Shooting Tips

- **To freeze the motion of a fast-moving subject**
Use a fast shutter speed such as 1/4000 sec. to 1/500 sec.
- **To blur a running child or animal and convey an impression of motion**
Use a medium shutter speed such as 1/250 sec. to 1/30 sec. While following the moving subject, press the shutter button to take the picture. If you use a telephoto lens, hold it steady to prevent camera shake.
- **To blur a flowing river or fountain**
Use a slow shutter speed of 1/30 sec. or slower. Use a tripod to prevent hand-held camera shake.
- **Set the shutter speed so that the aperture display does not blink.**

If you press the shutter button halfway and change the shutter speed while the aperture is displayed, the aperture display will also change to maintain the same exposure (amount of light reaching the image sensor). If you exceed the adjustable aperture range, the aperture display will blink to indicate that the standard exposure cannot be obtained.



If the exposure will be too dark, the maximum aperture (smallest number) will blink. If this happens, tap to display the setting screen and then tap [◀] (or turn the <⦿> dial to the left) to set a slower shutter speed or increase the ISO speed.

If the exposure will be too bright, the minimum aperture (highest number) will blink. If this happens, tap to display the setting screen and then tap [▶] (or turn the <⦿> dial to the right) to set a faster shutter speed or decrease the ISO speed.

Using Speedlite 90EX

To obtain a correct flash exposure of the subject, the flash output will be set automatically (autoflash exposure) to match the automatically-set aperture. The shutter speed can be set from 1/200 sec. to 30 sec.

Av: Changing the Depth of Field

To blur the background or to make everything near and far look sharp, use <Av> (Aperture-priority AE) to adjust the depth of field (range of acceptable focus).

* <Av> stands for Aperture value, which is the size of the diaphragm hole inside the lens.



Blurred background
(With a low aperture f/number: f/5.6)



Sharp foreground and background
(With a high aperture f/number: f/32)



1 Tap the shooting mode icon on the screen's upper left corner.

- The shooting mode selection screen will appear.



2 Tap [Av] on the screen.

3 Set the desired aperture.

- The higher the f/number, the wider the depth of field where sharper focus is obtained in both the foreground and background.
- When you tap the aperture, the setting screen will appear. Tap <◀/> or turn the <⦿> dial to set the aperture.
- Turning the <⦿> dial to the right will set a higher f/number (smaller aperture opening), and turning it to the left will set a lower f/number (larger aperture opening).

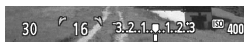

4 Take the picture.



Aperture Display

The higher the f /number, the smaller the aperture opening will be. The apertures displayed will differ depending on the lens. If no lens is attached to the camera, "00" will be displayed for the aperture.



Shooting Tips

- **When using an aperture with a high f /number or shooting in low light scenes, note that camera shake can occur.**

A higher aperture f /number will make the shutter speed slower.

Under low light, the shutter speed can be as long as 30 sec. In such cases, increase the ISO speed and hold the camera steady or use a tripod.

- **The depth of field depends not only on the aperture, but also on the lens and on the subject distance.**

Since wide-angle lenses have a wide depth of field (range of acceptable focus in front of and behind the point of focus), you need not set a high aperture f /number to obtain a sharp picture from the foreground to the background. On the other hand, a telephoto lens has a narrow depth of field.

And the closer the subject, the narrower the depth of field. A farther subject will have a wider depth of field.

- **Set the aperture so that the shutter speed display does not blink.**

If you press the shutter button halfway and change the aperture while the shutter speed is displayed, the shutter speed display will also change to maintain the same exposure (amount of light reaching the image sensor). If you exceed the adjustable shutter speed range, the shutter speed display will blink to indicate that the standard exposure cannot be obtained.



If the picture will be too dark, the “30” (30 sec.) shutter speed display will blink. If this happens, tap to display the setting screen and then tap [◀] (or turn the <⊙> dial to the left) to set a lower aperture f/number or increase the ISO speed.

If the picture will be too bright, the “4000” (1/4000 sec.) shutter speed display will blink. If this happens, tap to display the setting screen and then tap [▶] (or turn the <⊙> dial to the right) to set a higher aperture f/number or decrease the ISO speed.

Using Speedlite 90EX

To obtain a correct flash exposure, the flash output will be set automatically to match the set aperture (autoflash exposure). The shutter speed will be set automatically between 1/200 sec. - 30 sec. to suit the scene's brightness.

In low light, the main subject is exposed with the automatic flash, and the background is exposed with a slow shutter speed set automatically. Both the subject and background look properly exposed (automatic slow-speed flash sync). If you are handholding the camera, keep it steady to prevent camera shake. Using a tripod is recommended.

To prevent a slow shutter speed, under [📷 1: External Speedlite control], set [Flash sync. speed in Av mode] to [1/200-1/60 sec. auto] or [1/200 sec. (fixed)] (p.221).

Depth of Field Preview ☆

The aperture opening (diaphragm) changes only at the moment when the picture is taken. Otherwise, the aperture remains fully open. Therefore, when you look at the scene on the LCD monitor, the depth of field will look narrow.

You can check the depth of field with the procedure below.

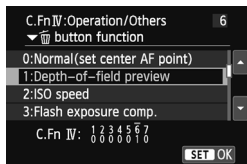

1 Enable depth-of-field preview.

- Under [**4**: Custom Function (C.Fn)], set [**6**: ▼ button function] to [**1**: Depth-of-field preview] (p.287).
- The Custom Function setting procedure is explained on page 282.

2 Exit the menu.

3 Press the <▼ > button.

- ▶ The aperture will stop down and you can check the depth of field.

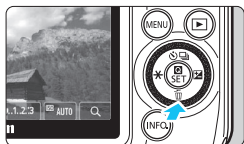

M: Manual Exposure

You can set both the shutter speed and aperture manually as desired. Set the exposure while referring to the exposure level scale. This method is called manual exposure.

* <M> stands for Manual.



1 Tap the shooting mode icon on the screen's upper left corner.

- The shooting mode selection screen will appear.

2 Tap [M] on the screen.



3 Set the shutter speed and aperture.

- When you tap the shutter speed and aperture, the setting screen will appear.

Tap [\blacktriangleleft]/[\blacktriangleright] or turn the \odot dial to set the shutter speed and aperture.

- Press the \blacktriangleleft \square \blacktriangleright button to set the shutter speed and aperture. You can also select the shutter speed and aperture and set it. (When selected, the pointer icon \blacktriangleleft \blacktriangleright is displayed above the value that can be changed.) Turn the \odot dial to set the shutter speed or aperture.

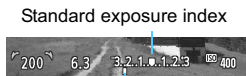

4 Focus the subject.

- Press the shutter button halfway.
- The exposure level mark \blacktriangleleft \blacktriangleright indicates how far the current exposure level is from the standard exposure level.

5 Set the exposure and take the picture.

- Check the exposure level and set the desired shutter speed and aperture.
- If the exposure level exceeds ± 3 stops, the $\langle \blacktriangleleft / \blacktriangleright \rangle$ will light up at $\langle -3 \rangle$ or $\langle +3 \rangle$ on the exposure level scale.



- In [**3: Auto Lighting Optimizer**], if the checkmark $\langle \checkmark \rangle$ for [**Disable during man expo**] is removed, it can be set in the $\langle \mathbf{M} \rangle$ mode (p.159).
- When ISO Auto is set, you can press the $\langle \blacktriangleleft * \blacktriangleright \rangle$ button to lock the ISO speed.
- After recomposing the picture, you can see the exposure level difference on the exposure level indicator (p.24) compared to when you pressed the $\langle \blacktriangleleft * \blacktriangleright \rangle$ button.

Using Speedlite 90EX

To obtain a correct flash exposure for the main subject, the flash output will be set automatically to match the set aperture (autoflash exposure). You can set the shutter speed from 1/200 sec. to 30 sec. or bulb.

BULB: Bulb Exposures

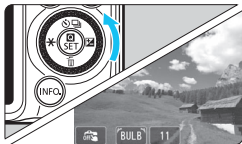

A bulb exposure keeps the shutter open for as long as you hold down the shutter button. It can be used to photograph fireworks and other subjects requiring long exposures.

As explained in step 3 on page 148, either tap [◀] or turn the <☉> dial to the left to select [BULB], then press the shutter button. The elapsed exposure time will be displayed on the LCD monitor.

- Since bulb exposures produce more noise than usual, the image may look a little grainy.
- When [📷4: Long exp. noise reduction] is set to [Auto] or [Enable], noise generated by the long exposure can be reduced (p.161).



- For bulb exposures, using a tripod is recommended.
- You can also use a Remote Controller (sold separately, p.291) for bulb exposures. When you press the Remote Controller's transmit button, the bulb exposure will start immediately or 2 sec. later. Press the button again to stop the bulb exposure.

MENU Changing the Metering Mode [☆]

Four methods (metering modes) to measure the subject's brightness are provided. Normally, evaluative metering is recommended. In Basic Zone modes, evaluative metering is set automatically.



1 Select [Metering mode].

- Under the [ 3] tab, select [Metering mode], then press </SET>.

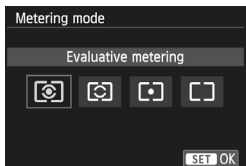

2 Set the metering mode.

- Select the metering mode, then press </SET>.



Evaluative metering

This is a general-purpose metering mode suited even for backlit subjects. The camera sets the exposure automatically to suit the scene.

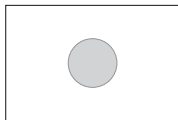

Partial metering

Effective when the background is much brighter than the subject due to backlighting, etc. The gray area in the left figure is where the brightness is metered to obtain the standard exposure.

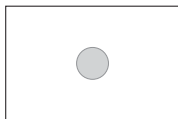





Spot metering

This is for metering a specific part of the subject or scene. The gray area in the left figure is where the brightness is metered to obtain the standard exposure. This metering mode is for advanced users.



 **Center-weighted average metering**

The brightness is metered at the image center and then averaged for the entire scene. This metering mode is for advanced users.

 When One-Shot AF is set: With , the exposure setting will be locked when you press the shutter button halfway and focus is achieved. With , , and , the exposure setting is set at the moment of exposure. (The exposure setting is not locked when you press the shutter button halfway.)

Setting Exposure Compensation ☆

☑ Setting Exposure Compensation

Set exposure compensation if the exposure (without flash) does not come out as desired. This feature can be used in Creative Zone modes (except <M>). You can set the exposure compensation up to ± 3 stops in 1/3-stop increments. You can set exposure compensation on the Live View screen or INFO. Quick Control screen. On the Live View screen, you can adjust the exposure compensation while checking the effect on the screen.



Increased exposure for a brighter image



Decreased exposure for a darker image



Dark exposure



Increased exposure for a brighter image

Using the Live View screen

- When you tap the exposure compensation scale, the setting screen appears. Tap [+]/[-] to adjust the exposure compensation.

Using the INFO. Quick Control screen

- On the INFO. Quick Control screen, select exposure compensation. Either tap [+]/[-] or press the <◀ * >/<▶ ☑ > button to adjust the exposure compensation.
- **Making it brighter:**
Tap [+] or press the <▶ ☑ > button.
(Increased exposure)
- **Making it darker:**
Tap [-] or press the <◀ * > button.
(Decreased exposure)
- **After taking the picture, cancel the exposure compensation by setting it back to 0.**



If you combine it with AEB (p.155), you can set it beyond ± 3 stops. Set it with [📷 3: Expo.comp./AEB] or the INFO. Quick Control screen.

Flash Exposure Compensation



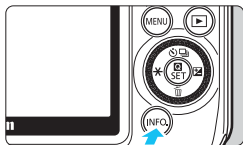

Set flash exposure compensation if the flash exposure of the subject does not come out as desired. You can set the exposure compensation up to ± 2 stops in 1/3-stop increments.



1 Display the INFO. Quick Control screen.





2 Select [].



- Press the <▲  /  > / <▼  > / <◀ * > / <▶  > button to select [ *].
- ▶ [Flash exposure comp.] will be displayed at the bottom.



3 Set the exposure compensation amount.

- To make the flash exposure brighter, turn the <◉> dial to the right. (Increased exposure)
To make it darker, turn the <◉> dial to the left. (Decreased exposure)
- Alternatively, you can press <◉ / SET > to display the setting screen. Tap [<◀> / ▶] or turn the <◉> dial to adjust the compensation amount.
- ▶ When you tap [], the <◉> icon will appear.
- After taking the picture, cancel the flash exposure compensation by setting it back to 0.

 If [ 3: Auto Lighting Optimizer] (p.159) is set to any setting other than [Disable], the image may look bright even if a decreased exposure compensation or decreased flash exposure compensation is set.

 You can also set flash exposure compensation with [Flash function settings] in [ 1: External Speedlite control] (p.222).

Auto Exposure Bracketing ☆

This feature takes exposure compensation a step further by varying the exposure automatically (up to ± 2 stops in 1/3-stop increments) with three shots as shown below. You can then choose the best exposure. This is called AEB (Auto Exposure Bracketing).



Standard exposure



Darker exposure
(Decreased exposure)



Brighter exposure
(Increased exposure)



- 1 Display the INFO. Quick Control screen.



AEB range

- 2 Select exposure compensation.

- 3 Set the AEB range.

- Turn the dial or tap []/[] to set the AEB range.
- You can also set both AEB and exposure compensation. Either tap []/[] or press the button to adjust the AEB range centering on exposure compensation setting.
- After you exit the setting, the AEB range will appear on the LCD monitor.



4 Take the picture.

- Press the shutter button completely. The three bracketed shots will be taken in this sequence: standard exposure, decreased exposure, and increased exposure.



AEB can also be set with the [CAMERA] tab's [Expo.comp./AEB].

Canceling AEB

- Follow steps 1 to 3 to turn off the AEB level display.
- The AEB setting will also be canceled automatically if the power is set to <OFF>, flash recycling is completed, etc.



Shooting Tips

● Using AEB with continuous shooting

If <CAMERA> continuous shooting (p.133) is set and you press the shutter button completely, the three bracketed shots will be taken continuously in this sequence: standard exposure, decreased exposure, and increased exposure.

● Using AEB with <CAMERA> single shooting

Press the shutter button three times to take the three bracketed shots. The three bracketed shots will be exposed in the following sequence: standard exposure, decreased exposure, and increased exposure.

● Using AEB with the self-timer or a Remote Controller (sold separately)

With the self-timer or a Remote Controller (<CAMERA> or <CAMERA>), you can take three continuous shots after a 10-sec. or 2-sec. delay. With <CAMERA> (p.136) set, the number of continuous shots will be three times the number set.



- AEB cannot be used with flash, Multi Shot Noise Reduction, Creative filter shooting, and bulb shooting.
- If [CAMERA: Auto Lighting Optimizer] (p.159) is set to any setting other than [Disable], the AEB's effect may be minimal.

✳ Locking the Exposure (AE Lock) ☆

You can lock the exposure when the area of focus is to be different from the exposure metering area or when you want to take multiple shots at the same exposure setting. Press the <◀✳> button to lock the exposure, then recompose and take the shot. This is called AE lock. It is effective for backlit subjects.

1 Focus the subject.

- Press the shutter button halfway.
- ▶ The exposure setting will be displayed.

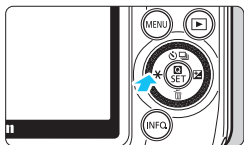

2 Press the <◀✳> button. (16)

- ▶ <✳> will appear and the exposure will be locked (AE lock).
- Press the <◀✳> button again to cancel the AE lock.





3 Recompose and take the picture.

- If you want to maintain the AE lock while taking more shots, hold down the <◀✳> button and press the shutter button to take another shot.

✱ Locking the Exposure (AE Lock)✱

AE Lock Effects

Metering Mode (p.151)	AF Point Selection Method (p.118-121)	
	Automatic Selection	Manual Selection
 ✱	AE lock is applied at the AF point that achieved focus.	AE lock is applied at the selected AF point.
	AE lock is applied at the center AF point.	

✱ During manual focus, AE lock is applied at the center AF point.

MENU Auto Correction of Brightness and Contrast ☆

If the image comes out dark or the contrast is low, the brightness and contrast can be corrected automatically. This function is called Auto Lighting Optimizer. The default setting is [Standard]. With JPEG images, the correction is done when the image is captured. For RAW images, it can be corrected with Digital Photo Professional (provided software, p.340).

In Basic Zone modes, [Standard] is set.

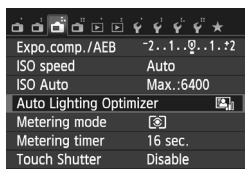

1 Select [Auto Lighting Optimizer].

- Under the [3] tab, select [Auto Lighting Optimizer], then press <Q/SET>.



2 Select the setting.

- Select the desired setting, then press <Q/SET>.

3 Take the picture.

- The image will be recorded with the brightness and contrast corrected if necessary.



- Under [4: Custom Functions (C.Fn)], if [3: Highlight tone priority] is set to [1: Enable], the Auto Lighting Optimizer will be set automatically to [Disable] and the setting cannot be changed.
- Depending on the shooting conditions, noise may increase.
- If a setting other than [Disable] is set and you use exposure compensation or flash exposure compensation to darken the exposure, the image may still come out bright. If you want a darker exposure, set this function to [Disable].



In step 2, if you press the <INFO.> button and uncheck <✓> the [Disable during man expo] setting, the Auto Lighting Optimizer can be set in the <M> mode.

MENU Noise Reduction Settings ☆

High ISO Speed Noise Reduction

This function reduces the noise generated in the image. Although noise reduction is applied at all ISO speeds, it is particularly effective at high ISO speeds. At low ISO speeds, the noise in the darker parts of the image (shadow areas) is further reduced. Change the setting to suit the noise level.

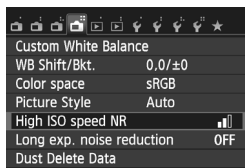

1 Select [High ISO speed NR].

- Under the [📷4] tab, select [High ISO speed NR], then press <Q>/SET>.

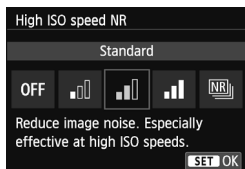

2 Set the setting.

- Select the desired setting, then press <Q>/SET>.
- ▶ The setting screen closes and the menu will reappear.

● [Multi Shot Noise Reduction]

Noise reduction with higher image quality than when [High] is applied. For a single photo, four shots are taken in a burst and merged automatically into a single JPEG image.

3 Take the picture.

- The image will be recorded with noise reduction applied.

⚠ With [High] or [Multi Shot Noise Reduction], the maximum burst for continuous shooting will greatly decrease.

About [Multi Shot Noise Reduction]

- The following functions cannot be set: AEB, WB bracketing, [CAMERA 4: Long exp. noise reduction], RAW + L/RAW. If any of these has already been set, [Multi Shot Noise Reduction] cannot be set.
- Flash shooting is not possible.
- You cannot set [Multi Shot Noise Reduction] for bulb exposures.
- If you turn off the power or change the shooting mode to a Basic Zone mode, movie shooting, or bulb, the setting will change to [Standard].
- Depending on shooting conditions, noise may appear on the image periphery.
- If the images are greatly misaligned due to camera shake or if there is a moving subject, the noise reduction effect may be minimal.
- The image alignment may not function properly with repetitive patterns (lattice, stripes, etc.) or flat, single-tone images.
- Recording the image to the card will take longer than with normal shooting. During the processing of the images, "BUSY" will be displayed and you cannot take another picture until the processing is completed.
- [CAMERA 4: Dust Delete Data] cannot be set.
- If [Multi Shot Noise Reduction] is set, direct printing is not possible. Select a setting other than [Multi Shot Noise Reduction] and perform direct printing.



If you play back a RAW + L or RAW image with the camera or print an image directly, the effect of the high ISO speed noise reduction may look minimal. Check the noise reduction effect or print noise-reduced images with Digital Photo Professional (provided software, p.340).

Long Exposure Noise Reduction

You can reduce noise in long exposures.

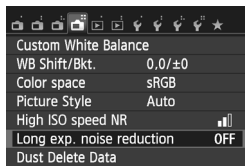

1 Select [Long exp. noise reduction].

- Under the [CAMERA 4] tab, select [Long exp. noise reduction], then press <Q/SET>.

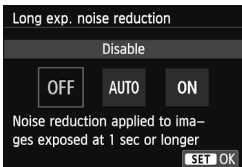

2 Set the setting.

- Select the desired setting, then press <Q>/SET>.
- ▶ The setting screen closes and the menu will reappear.

● [Auto]

For 1 sec. or longer exposures, noise reduction is performed automatically if noise typical of long exposures is detected. This [Auto] setting is effective in most cases.

● [Enable]

Noise reduction is performed for all exposures of 1 sec. or longer. The [Enable] setting may be able to reduce noise that otherwise cannot be detected with the [Auto] setting.

3 Take the picture.

- The image applied with noise reduction is recorded.

- With [Auto] and [Enable], the noise reduction process after the picture is taken may take the same amount of time as the exposure. You cannot take another picture until the noise reduction process is completed.
- Images taken at ISO 1600 or higher may look grainier with the [Enable] setting than with the [Disable] or [Auto] setting.
- If [Auto] and [Enable] are set and you are taking a long exposure, "BUSY" will be displayed during the noise reduction process and you cannot take another picture.

MENU Lens Peripheral Illumination / Chromatic Aberration Correction

Peripheral light fall-off is a phenomenon that makes the image corners look darker due to the lens characteristics. Color fringing along subject outlines is another chromatic aberration. Both lens aberrations can be corrected. RAW images can be corrected with Digital Photo Professional (provided software, p.340).

Peripheral Illumination Correction

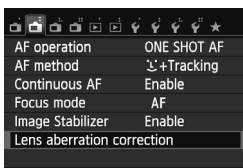

1 Select [Lens aberration correction].

- Under the [2] tab, select [Lens aberration correction], then press <Q/SET>.

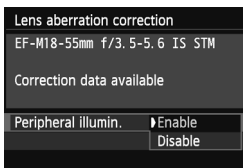



2 Select the setting.

- Check that [Correction data available] is displayed for the attached lens.
- Select [Peripheral illumin.], then press <Q/SET>.
- Select [Enable], then press <Q/SET>.
- If [Correction data not available] is displayed, see “About the Lens Correction Data” on page 165.

3 Take the picture.

- The image will be recorded with the peripheral illumination corrected.

 Depending on shooting conditions, noise may appear on the image periphery.

-  The correction amount applied will be slightly lower than the maximum correction amount that can be set with Digital Photo Professional (provided software).
- The higher the ISO speed, the lower the correction amount will be.

Chromatic Aberration Correction

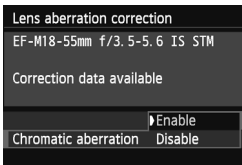

1 Select the setting.

- Check that [**Correction data available**] is displayed for the attached lens.
- Select [**Chromatic aberration**], then press <Q/SET>.
- Select [**Enable**], then press <Q/SET>.
- If [**Correction data not available**] is displayed, see “About the Lens Correction Data” on the next page.

2 Take the picture.

- The image will be recorded with the chromatic aberration corrected.

- With [**Enable**], the maximum burst for continuous shooting will greatly decrease.
- If you play back a RAW image shot with the chromatic aberration corrected, the image will be displayed on the camera without the chromatic aberration correction applied. Check the chromatic aberration correction with Digital Photo Professional (provided software, p.340).



About the Lens Correction Data

The camera already contains lens peripheral illumination correction data and chromatic aberration correction data for approx. 25 lenses. If you select **[Enable]**, the peripheral illumination correction and chromatic aberration correction will be applied automatically for any lens whose correction data is registered in the camera.

With EOS Utility (provided software), you can check which lenses have their correction data registered in the camera. You can also register the correction data for unregistered lenses. For details, refer to the PDF Software Instruction Manual (DVD-ROM) for EOS Utility.

* There is no need to register EF-M lenses.

Notes for Peripheral Illumination Correction and Chromatic Aberration Correction

- 
 - Corrections cannot be applied afterwards to JPEG images captured when **[Disable]** was set.
 - When using a non-Canon lens, setting the corrections to **[Disable]** is recommended, even if **[Correction data available]** is displayed.
 - If you use the magnified view during shooting, the peripheral illumination correction and chromatic aberration correction will not be reflected in the image shown on the screen.
- 
 - If the effect of the correction is not visible, magnify the image and check it.
 - The corrections are also applied when an Extender is attached.
 - If the correction data for the attached lens is not registered to the camera, the result will be the same as when the correction is set to **[Disable]**.
 - If the lens does not have distance information, the correction amount will be lower.

Adjusting the Picture Style ☆

You can customize a Picture Style by adjusting individual parameters such as **[Sharpness]** and **[Contrast]**. To see the resulting effects, take test shots. To customize **[Monochrome]**, see page 169.

1 Display the Quick Control screen.

2 Tap [A].

3 Tap a Picture Style to select it.

- After selecting a Picture Style, press the <INFO.> button.
- ▶ The Detail setting screen will appear.

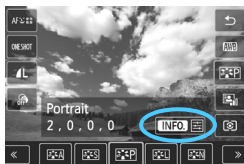

4 Select a parameter.

- Tap the parameter to be set.





5 Set the parameter.

- Tap [◀]/[▶] to set the parameter, then tap [↩].

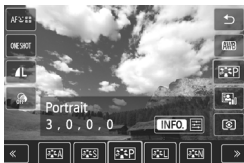

- By selecting [**INFO. Default set.**] in step 5, you can revert the respective Picture Style to its default parameter settings.
- To shoot with the Picture Style you modified, follow step 3 on page 114 to select the modified Picture Style and then shoot.

Parameter Settings and Effects

Sharpness

You can adjust the sharpness of the subject.

To make it less sharp, set it toward the **0** end. The closer it is to **0**, the softer the image will look.

To make it sharper, set it toward the **7** end. The closer it is to **7**, the sharper the image will look.

Contrast

Adjusts the image contrast and the vividness of colors.

To decrease the contrast, set it toward the minus end. The closer it is to **-**, the more muted the image will look.

To increase the contrast, set it toward the plus end. The closer it is to **+**, the crisper the image will look.

Saturation

The image's color saturation can be adjusted.

To decrease the color saturation, set it toward the minus end. The closer it is to **-**, the more diluted the colors will look.

To increase the color saturation, set it toward the plus end. The closer it is to **+**, the bolder the colors will look.

Color tone

The skin tones can be adjusted.

To make the skin tone redder, set it toward the minus end. The closer it is to **-**, the redder the skin tone will look.

To make the skin tone more yellow, set it toward the plus end. The closer it is to **+**, the more yellow the skin tone will look.

Monochrome Adjustment

For Monochrome, you can also set **[Filter effect]** and **[Toning effect]** in addition to **[Sharpness]** and **[Contrast]** explained on the preceding page.

Filter Effect



With a filter applied to a monochrome image, you can make white clouds or green trees stand out more.

Filter	Sample Effects
N : None	Normal black-and-white image with no filter effects.
Ye: Yellow	The blue sky will look more natural, and the white clouds will look crisper.
Or: Orange	The blue sky will look slightly darker. The sunset will look more brilliant.
R : Red	The blue sky will look quite dark. Fall leaves will look crisper and brighter.
G : Green	Skin tones and lips will appear muted. Tree leaves will look crisper and brighter.



Increasing the **[Contrast]** will make the filter effect more pronounced.

Toning Effect



By applying a toning effect, you can create a monochrome image in that color. It can make the image look more impressive.

The following can be selected: **[N:None]**, **[S:Sepia]**, **[B:Blue]**, **[P:Purple]** or **[G:Green]**.

Registering Customized Picture Styles ☆

You can select a base Picture Style such as [Portrait] or [Landscape], adjust its parameters as desired and register it under [User Def. 1], [User Def. 2], or [User Def. 3].

You can create multiple Picture Styles whose parameter settings such as sharpness and contrast are different.

You can also adjust the parameters of a Picture Style that has been registered to the camera with EOS Utility (provided software, p.340).

1 Display the Quick Control screen.

2 Tap [].



3 Tap a User Def. to select it.

- Select a [User Def.*] style, then press the <INFO.> button.
- ▶ The Detail setting screen will appear.



4 Select the base Picture Style.

- Tap the Picture Style to be used as the base.
- To adjust the parameters of a Picture Style that has been registered to the camera with EOS Utility (provided software), select the Picture Style here.





5 Select a parameter.

- Tap the parameter to be set.



6 Set the parameter.

- Tap [◀]/[▶] to set the parameter, then tap [↩].
For details, see “Adjusting the Picture Style” on pages 166-169.



- ▶ The base Picture Style will be indicated under [User Def.*].



- If a Picture Style has already been registered under [User Def.*], changing the base Picture Style in step 4 will nullify the parameter settings of the registered Picture Style.
- If you execute [Clear all camera settings] (p.216), all the [User Def.*] settings will revert to their defaults. Picture Styles registered via EOS Utility (provided software) will have only their modified parameters reverted to their default settings.



- To shoot with a registered Picture Style, follow step 3 on page 114 to select [User Def.*], then shoot.
- Regarding the procedure to register a Picture Style file to the camera, refer to the EOS Utility Instructions (p.340).

WB: Matching the Light Source ☆

The function adjusting the color tone so that white objects look white in the picture is called white balance (WB). Normally, the <AWB> (Auto) setting will obtain the correct white balance. If natural-looking colors cannot be obtained with <AWB>, you can select the white balance that matches the light source or set it manually by shooting a sheet of white paper, etc.

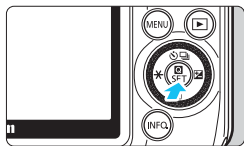

1 Display the Quick Control screen.



2 Tap a white balance to select it.

Custom White Balance

Custom white balance enables you to manually set the white balance for a specific light source for better accuracy. Perform this procedure under the actual light source to be used.

1 Photograph a white object.

- Fill the LCD monitor screen with a sheet of white paper, etc.
- Focus manually and set the standard exposure for the white object.
- You can set any white balance.

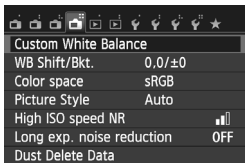

2 Select [Custom White Balance].

- Under the [4] tab, select [Custom White Balance], then press <Q/SET>.
- ▶ The custom white balance selection screen will appear.



3 Import the white balance data.

- Select the image that was captured in step 1, then press <Q/SET>.
- ▶ On the dialog screen that appears, select [OK] and the data will be imported.
- When the menu reappears, press the <MENU> button to exit the menu.



4 Press <Q/SET>.

- ▶ Display the Quick Control screen.

5 Select the custom white balance.

- Select [WB], then press <Q/SET>.



- If the exposure obtained in step 1 differs greatly from the standard exposure, a correct white balance may not be obtained.
- An image captured while the Picture Style was set to [Monochrome] (p.115) or an image processed with a Creative filter cannot be selected in step 3.



Instead of a white object, an 18% gray card (commercially available) can produce a more accurate white balance.

MENU \pm WB Adjusting the Color Tone for the Light Source [☆]

You can correct the white balance that has been set. This adjustment will have the same effect as using a commercially-available color temperature conversion filter or color compensating filter. Each color can be corrected to one of nine levels.

This function is for advanced users who are familiar with using color temperature conversion or color compensating filters.

White Balance Correction

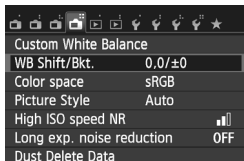

1 Select [WB Shift/Bkt.].

- Under the [4] tab, select [WB Shift/Bkt.], then press <Q/SET>.
- The WB correction/WB bracketing screen will appear.

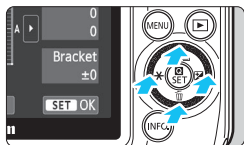

2 Set the white balance correction.

- Press the <▲ [WB Shift/Bkt.] / [play] / > / ▼ [trash] / > / < [star] / > / < [info] / > button to move the “■” mark on the screen to the desired position.
- B is for blue, A for amber, M for magenta, and G for green. The color in the respective direction will be corrected.
- On the upper right, “Shift” indicates the direction and correction amount.
- Pressing the <INFO.> button will cancel all the [WB Shift/Bkt.] settings.
- Press <Q/SET> to exit the setting and return to the menu.

Sample setting: A2, G1

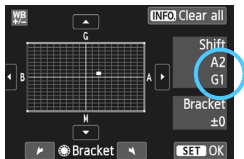

One level of the blue/amber correction is equivalent to approx. 5 mireds of a color temperature conversion filter. (Mired: Measuring unit indicating the density of a color temperature conversion filter.)

White Balance Auto Bracketing

With just one shot, three images having a different color balance can be recorded simultaneously. Based on the color temperature of the current white balance setting, the image will be bracketed with a blue/amber bias or magenta/green bias. This is called white balance bracketing (WB-BKT). White balance bracketing is possible up to ± 3 levels in single-level increments.

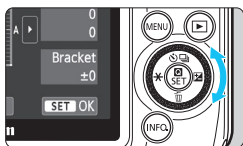

B/A bias ± 3 levels

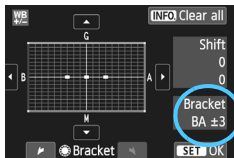

Set the white balance bracketing amount.

- In step 2 for white balance correction, when you turn the  dial, the “■” mark on the screen will change to “■■■” (3 points). Turning the dial to the right sets the B/A bracketing, and turning it to the left sets the M/G bracketing.
- ▶ On the right, “Bracket” indicates the bracketing direction and correction amount.
- Pressing the <INFO.> button will cancel all the [WB Shift/Bkt.] settings.
- Press <Q/SET> to exit the setting and return to the menu.

Bracketing Sequence

The images will be bracketed in the following sequence: 1. Standard white balance, 2. Blue (B) bias, and 3. Amber (A) bias, or 1. Standard white balance, 2. Magenta (M) bias, and 3. Green (G) bias.



- During WB bracketing, the maximum burst for continuous shooting will be lower and the number of possible shots will also decrease to approx. one-third the normal number.
- You can also set white balance correction and AEB together with white balance bracketing. If you set AEB in combination with white balance bracketing, a total of nine images will be recorded for a single shot.
- Since three images are recorded for one shot, it takes longer to record the shot to the card.
- “BKT” stands for bracketing.

MENU Setting the Color Reproduction Range ☆

The range of reproducible colors is called the color space. With this camera, the color space for captured images can be set to sRGB or Adobe RGB. For normal shooting, sRGB is recommended. In Basic Zone modes, sRGB is set.

1 Select [Color space].

- Under the [CAMERA] tab, select [Color space], then press <Q/SET>.

2 Set the desired color space.

- Select [sRGB] or [Adobe RGB], then press <Q/SET>.

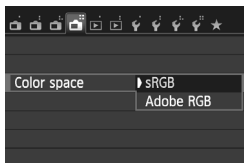

About Adobe RGB

This is mainly for industrial use (printing machines, etc.). This setting is not recommended if you do not know about image processing, Adobe RGB, and Design rule for Camera File System 2.0 (Exif 2.21 or higher). The image will look very subdued in a sRGB personal computer environment and with printers not compatible with Design rule for Camera File System 2.0 (Exif 2.21 or higher). Post-processing of the image with software will therefore be required.

- If the captured still photo was shot in the Adobe RGB color space, the first character in the file name will be an underscore “_”.
- The ICC profile is not appended. Refer to explanations about the ICC profile in the PDF Software Instruction Manual on the DVD-ROM.



Movies shot with your EOS M have a different look and feel than those shot with a conventional camcorder. Try creating shallow focus effects by using a large lens aperture, and take advantage of great quality in low light conditions.

5

Shooting Movies



Set the Mode Dial to <[Movie Icon]> to shoot movies. The movie recording format will be MOV.



Cards that can record movies

When shooting movies, use a large-capacity SD card rated SD Speed Class 6 “CLASS 6” or higher.

If the card's writing speed is slow, the movie may not be recorded properly. Also, if the card's reading speed is slow, movies recorded on the card may not play properly.

To check the card's read/write speed, refer to the card manufacturer's Web site.



About Full HD 1080

Full HD 1080 indicates compatibility with High-Definition featuring 1080 vertical pixels (scanning lines).



Shooting Movies

Connecting the camera to a TV set is recommended to play back the movies shot (p.247, 251).

Autoexposure Shooting

When you select the Movie shooting mode [**MOVIE**], autoexposure is set to adjust the brightness automatically.



1 Set the Mode Dial to <[**MOVIE**]>.

2 Select [**MOVIE**] (Movie auto exposure) for the shooting mode.

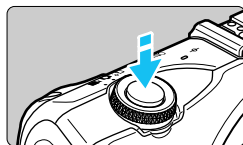

3 Focus the subject.

- Before shooting a movie, focus with AF or manual focus (p.116-126).
- By default, [**Movie Servo AF: Enable**] (p.199) is set for continuous focusing.
- When [**Movie Servo AF**] is set to [**Enable**], you can tap [**SERVO AF**] on the screen's lower left to stop/start the focusing. If you stop the focusing, the AF point will turn gray.



Recording movie

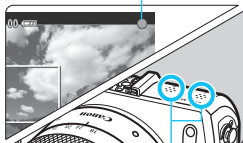

Microphone

4 Shoot the movie.

- Press the <[**MOVIE**]> (Movie start/stop) button to start shooting a movie. To stop shooting the movie, press the <[**MOVIE**]> (Movie start/stop) button again.
- ▶ While the movie is being shot, the "[**MOVIE**]" mark will be displayed on the upper right of the screen.

- While shooting a movie, be careful not to cover the microphone with your finger.



With certain lenses, focus cannot be achieved with AF. Focus manually instead (p.126).



- If **[Movie Servo AF: Disable]** is set, you can focus by pressing the shutter button halfway.
- The ISO speed (100-6400), shutter speed, and aperture are set automatically.
- Press the <◀ * > button to lock the current exposure setting (AE lock) (p.157). To release the AE lock, press the <◀ * > button again. In movie shooting mode, you can tap [*****] to lock the exposure/release the AE lock.
- You can then set the exposure compensation by pressing the <▶ ☒ > button to display the range that can be set [^{3.2.1.1, 4.1.2.3}] and then turning the <◉ > dial.
- Pressing the shutter button halfway displays the shutter speed, aperture, and ISO speed on the screen's bottom. This is the exposure setting for taking a still photo (p.182). The exposure setting for movie shooting is not displayed. Note that the exposure setting for movie shooting may differ from that for still photo shooting.

Using an EX-series Speedlite (Sold Separately) Equipped with an LED Light

This camera is compatible with the function turning on the LED light automatically in low-light conditions during autoexposure shooting. **For details, refer to the Speedlite's instruction manual.**

Manual Exposure Shooting

In the [M] shooting mode (Movie manual exposure), you can freely set the shutter speed, aperture, and ISO speed for movie shooting. Using manual exposure to shoot movies is for advanced users.



1 Set the Mode Dial to <M>.

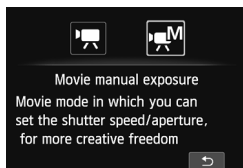

2 Select [M] (Movie manual exposure) for the shooting mode.

3 Set the shutter speed and aperture.

- When you tap the shutter speed and aperture, the setting screen will appear. Tap [◀]/[▶] or turn the <Dial> to set the shutter speed and aperture.
- Press the <▶ [A] > button to set the shutter speed and aperture. You can also select the shutter speed and aperture and set it. (When selected, the pointer icon <▶ [A] > is displayed above the value that can be changed.) Turn the <Dial> to set the shutter speed or aperture. The shutter speeds that can be set depend on the frame rate <FPS>.
 - 60, 50 : 1/4000 sec. - 1/60 sec.
 - 30, 25, 24 : 1/4000 sec. - 1/30 sec.



4 Set the ISO speed.

- As with still photos, you can set the ISO speed with 1. Menu screen, 2. Shooting screen, 3. INFO. Quick Control screen, 4. <▼ [A] > button assigned with the menu's Custom Function (p.287).

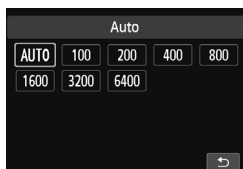

5 Focus and shoot the movie.

- The procedure is the same as steps 3 and 4 for “Autoexposure Shooting” (p.178).

ISO speed during manual-exposure shooting

- With **[Auto]**, the ISO speed will be set automatically within ISO 100 - 6400.
- You can set the ISO speed manually within ISO 100 - 6400 in whole-stop increments. Under **[F4: Custom Functions (C.Fn)]**, if **[2: ISO expansion]** is set to **[1: On]**, the manual setting range will expand so you can also select “H” (equivalent to ISO 12800).
- Under **[F4: Custom Functions (C.Fn)]**, if **[3: Highlight tone priority]** is set to **[1: Enable]**, the ISO speed will be ISO 200 - 6400.



- Since shooting a movie at ISO 12800 may result in much noise, it is designated as an expanded ISO speed (displayed as “H”).
- The maximum ISO speed manual setting range is different for movie shooting and still photo shooting. If **[2: ISO expansion]** under **[F4: Custom Functions (C.Fn)]** is set to **[1: On]** and you switch from still photo shooting to movie shooting, the maximum manual ISO speed will change from “H” for still photos (equivalent to ISO 25600) to “H” for movies (equivalent to ISO 12800). Even if you switch back to still photo shooting, the ISO speed will not revert to the original setting.
- You cannot set exposure compensation.
- Changing the shutter speed or aperture during movie shooting is not recommended since the changes in the exposure will be recorded.
- If you change the shutter speed while shooting under fluorescent or LED lighting, image flicker may be recorded.



- When ISO Auto is set, you can press the **<MFn>** button to lock the ISO speed.
- After recomposing the picture, you can see the exposure level difference on the exposure level indicator (p.175) compared to when you pressed the **<MFn>** button.
- When **[C1: Histogram disp]** is set to a setting other than **[Disable]**, you can press the **<INFO.>** button to display the histogram.
- When shooting a movie of a moving subject, a shutter speed of 1/30 sec. to 1/125 sec. is recommended. The faster the shutter speed, the less smooth the subject’s movement will look.

Movie Shooting Screen

- Each time you press the <INFO.> button, the information display will change.

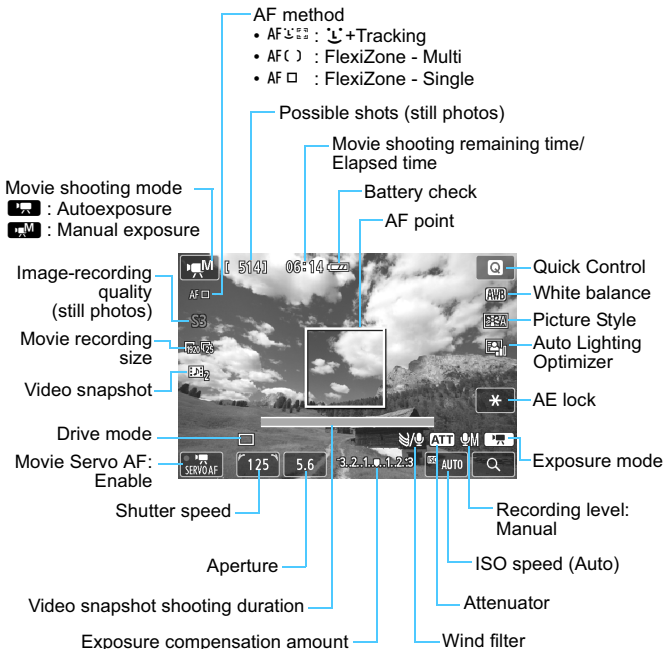

- * When an Eye-Fi card is inserted in the camera, the Eye-Fi transmission status (p.294) will be displayed.





When movie shooting starts, the movie shooting remaining time will change to the elapsed time.

During movie shooting, note the following:



- If <AWB> is set and the ISO speed or aperture changes during movie shooting, the white balance may also change.
- If you shoot a movie under fluorescent or LED lighting, the movie may flicker.
- Zooming the lens during movie shooting is not recommended. Zooming the lens can cause changes in the exposure regardless of whether the lens' maximum aperture changes or not. Exposure changes may be recorded as a result.
- **Cautions for movie shooting are on pages 201 and 202.**



- Movie-related settings are under the [ 1] tab (p.197).
- A movie file is recorded each time you shoot a movie. If the file size exceeds 4 GB, a new file will be automatically created.
- The movie image's field of view is approx. 100% (with movie recording size set to []).
- The sound will be recorded in stereo by the camera's built-in microphone (p.178).
- Most commercially-available external stereo microphones with a 3.5 mm diameter miniplug can be connected to the camera. If an external microphone has been connected to the camera's external microphone IN terminal (p.22), it will be given priority over the built-in microphone.
- You can use the Remote Controller RC-6 (sold separately, p.291) to start and stop the movie shooting if the drive mode is < >. Set the shooting timing switch to <2> (2-sec. delay), then press the transmit button. If the switch is set to < > (immediate shooting), still photo shooting will take effect.
- With a fully-charged Battery Pack LP-E12, the total movie shooting time will be as follows: approx. 1 hr. 30 min. at room temperature (23°C/73°F), and approx. 1 hr. 20 min. at low temperature (0°C/32°F).
- If the Speedlite 90EX is attached, set the Speedlite's power to <OFF>.

Final Image Simulation

The final image simulation is a function that allows you to see the effects of the Picture Style, white balance, etc., on the image.

During movie shooting, the image displayed will automatically reflect the effects of the settings listed below.

Final image simulation for movie shooting

- Picture Style

* All settings such as sharpness, contrast, color saturation, and color tone will be reflected.

- White balance
- White balance correction
- Exposure
- Depth of field
- Auto Lighting Optimizer
- Peripheral illumination correction
- Highlight tone priority

Using the final image simulation you can check the effects of various settings on the image but the colors displayed on the screen will not fully match those of the recorded image.

Shooting Photos During Movie Shooting

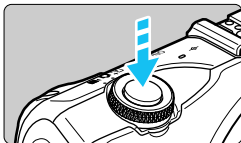

While shooting a movie, you can also take a still photo by pressing the shutter button completely.

Taking still photos during movie shooting

- If you take a still photo during movie shooting, the movie will record a still moment lasting approx. 1 sec.
- The still photo is recorded to the card, and when the movie image returns, the movie shooting will resume.

- The movie and still photo will be recorded as separate files on the card.
- Functions particular to still photo shooting are shown below. Other functions will be the same as for movie shooting.

Function	Settings
Image-Recording Quality	As set in [ 1: Image quality]. When the movie recording size is [1920x1080] or [1280x720], the aspect ratio will be 16:9. When the size is [640x480], the aspect ratio will be 4:3.
ISO Speed*	<ul style="list-style-type: none"> • With autoexposure shooting: Automatically set within ISO 100 - 6400. • With manual exposure shooting: See “ISO speed during manual-exposure shooting” on page 181.
Exposure Setting	<ul style="list-style-type: none"> • Autoexposure shooting: Automatically-set shutter speed and aperture (displayed when pressing the shutter button halfway). • Manual exposure shooting: Manually-set shutter speed and aperture.
AEB	Canceled

* If highlight tone priority is set, the ISO speed range will start from ISO 200.

How to focus still photos taken during movie shooting is explained on page 200.

Continuous still photo shooting before movie shooting

Before starting to shoot movies, you can use continuous shooting in the same way as when shooting still photos using One-Shot AF.

 Still photo shooting is not possible while shooting video snapshots.

- 
- The self-timer works before you start shooting the movie. During movie shooting, the camera will switch to single shooting.
 - Regardless of the drive mode setting, single shooting will take effect for still photo shooting during movie shooting.
 - One-Shot AF is the only AF operation mode available in movie shooting mode.

Shooting Function Settings

Function settings particular to movie shooting are explained here.

Quick Control

The following can be set: AF method, image-recording quality (still photos), movie-recording size, video snapshots, white balance, Picture Style, and Auto Lighting Optimizer.

The operation procedure is the same as with still photos (p.50).

MENU Setting the Movie-recording Size

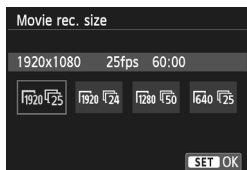

The menu option [**1: Movie rec. size**] enables you to select the movie's image size [****x****] and frame rate [/**] (frames recorded per second). The /** (frame rate) switches automatically depending on the [**2: Video system**] setting.







● Image size

- 1920 [1920x1080]** : Full High-Definition (Full HD) recording quality.
The aspect ratio will be 16:9.
- 1280 [1280x720]** : High-Definition (HD) recording quality.
The aspect ratio will be 16:9.
- 640 [640x480]** : Standard-definition recording quality.
The aspect ratio will be 4:3.

● Frame rate (fps: frames per second)

- 30/60** : For areas where the TV format is NTSC (North America, Japan, Korea, Mexico, etc.).
- 25/50** : For areas where the TV format is PAL (Europe, Russia, China, Australia, etc.).
- 24** : Records the movie in a cinema style at 24 fps.

Total Movie Recording Time and File Size Per Minute

Movie-Recording Size		Total Recording Time (approx.)			File Size (approx.)
		4 GB Card	8 GB Card	16 GB Card	
[1920x1080]		11 min.	22 min.	44 min.	330 MB/min.
					
					
[1280x720]		11 min.	22 min.	44 min.	330 MB/min.
					
[640x480]		46 min.	1 hr. 32 min.	3 hr. 4 min.	82.5 MB/min.
					

● About Movie Files Exceeding 4 GB

Even if you shoot a movie exceeding 4 GB, you can keep shooting without interruption.

During movie shooting, approx. 30 sec. before the movie reaches the 4 GB file size, the elapsed shooting time displayed in the movie shooting screen will start blinking. If you keep shooting the movie and the file size exceeds 4 GB, a new movie file will be created automatically and the elapsed shooting time or time code will stop blinking.

When you play back the movie, you will have to play each movie file individually. Movie files cannot play back consecutively automatically. After the movie playback ends, select the next movie to be played.

● Movie Shooting Time Limit

The maximum recording time of one movie clip is 29 min. 59 sec. If the movie shooting time reaches 29 min. 59 sec., the movie shooting will stop automatically. You can resume movie shooting by pressing the <●> (Movie start/stop) button. (A new movie file is recorded.)

 An increase of the camera's internal temperature may cause movie shooting to stop before the maximum recording time shown in the table above (p.201).

MENU Shooting Video Snapshots

You can easily create a short movie with the video snapshot function. A video snapshot is a short movie clip lasting approx. 2 sec., 4 sec., or 8 sec. A collection of video snapshots is called a video snapshot album and can be saved to the card as a single movie file. By changing the scene or angle in each video snapshot, you can create dynamic short movies.

A video snapshot album can also be played together with background music (p.194, 240).

Video Snapshot Album Concept

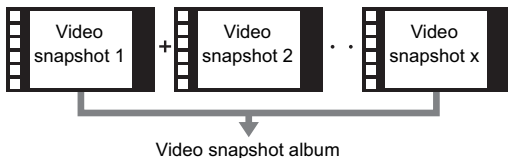

Setting the Video Snapshot Shooting Duration

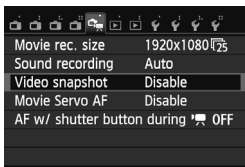

1 Select [Video snapshot].

- Under the [1] tab, select [Video snapshot], then press <Q>/SET>.

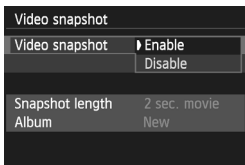

2 Select [Enable].

- Select [Enable], then press <Q>/SET>.

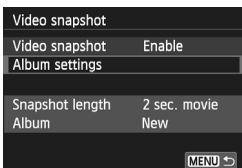

3 Select [Album settings].

- Select [**Album settings**], then press <Q/SET>.
- If you want to continue shooting for an existing album, go to “Adding to Existing Album” (p.193).

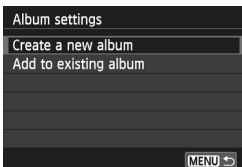

4 Select [Create a new album].

- Select [**Create a new album**], then press <Q/SET>.

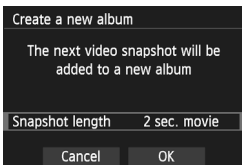

5 Select the Snapshot length.

- Press <Q/SET> and use the <▲⊙/☐>/<▼☒> button to select the snapshot's length, then press <Q/SET>.



Shooting duration

6 Select [OK].

- Select [**OK**], then press <Q/SET>.
- Press the <MENU> button to exit the menu and return to the movie shooting screen. A blue bar will appear to indicate the snapshot length.
- Go to “Creating a Video Snapshot Album” (p.191).

Creating a Video Snapshot Album



7 Shoot the first video snapshot.

- Press the <●> (Movie start/stop) button to shoot a movie.
- ▶ The blue bar indicating the shooting duration will gradually decrease. After the set shooting duration elapses, the shooting stops automatically.
- ▶ After the LCD monitor turns off and the Power/access lamp blinks, the confirmation screen will appear (p.192).

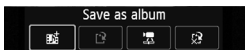

8 Save as a video snapshot album.

- Press the <▶ []> button to select [Save as album], then press <[Q]/SET>.
- ▶ The movie clip will be saved as the video snapshot album's first video snapshot.

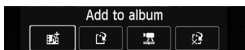

9 Continue to shoot more video snapshots.



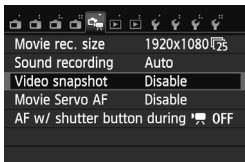



- Repeat step 7 to shoot the next video snapshot.
- Press the <▶ []> button to select [Add to album], then press <[Q]/SET>.
- To create another video snapshot album, select [Save as a new album], then select [OK].













10 Quit the video snapshot shooting.

- Set [Video snapshot] to [Disable]. **To return to normal movie shooting, be sure to set [Disable].**
- Press the <MENU> button to exit the menu and return to the normal movie shooting screen.

Options in Steps 8 and 9

Function	Description
 Save as album (Step 8)	The movie clip will be saved as the video snapshot album's first video snapshot.
 Add to album (Step 9)	The video snapshot just recorded will be added to the album recorded immediately before.
 Save as a new album (Step 9)	A new video snapshot album is created and the movie clip is saved as the first video snapshot. The new album will be a different file from the previously recorded album.
 Playback video snapshot (Steps 8 and 9)	The video snapshot just recorded will be played. For playback operations, see the table below.
 Do not save to album (Step 8)  Delete without saving to album (Step 9)	If you want to delete the video snapshot you just recorded and not save it to the album, select [OK].

[Playback video snapshot] Operations

Function	Playback Description
 Play	Each time you press <Q/SET>, you can play or pause the just-recorded video snapshot.
 First frame	Displays the first scene of the album's first video snapshot.
 Skip backward*	Each time you press <Q/SET>, the video snapshot skips back by a few seconds.
 Previous frame	Each time you press <Q/SET>, the previous frame is displayed. If you hold down <Q/SET>, it will rewind the movie.
 Next frame	Each time you press <Q/SET>, the movie will play frame-by-frame. If you hold down <Q/SET>, it will fast forward the movie.
 Skip forward*	Each time you press <Q/SET>, the video snapshot skips forward by a few seconds.
 Last frame	Displays the last scene of the album's last video snapshot.
	Playback position
mm' ss"	Playback time (minutes:seconds)
 Volume	You can adjust the built-in speaker's (p.239) volume by turning the <Q> dial.
MENU 	The previous screen will reappear.

* With [Skip backward] or [Skip forward], the skipping duration will correspond to the number of seconds set under [Video snapshot] (approx. 2 sec., 4 sec., or 8 sec.).

Adding to Existing Album

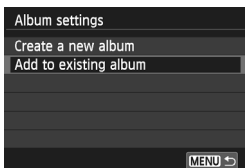

1 Select [Add to existing album].

- Follow step 4 on page 190 to select [Add to existing album], then press <Q/SET>.



2 Select an existing album.

- Press the <◀ * >/<▶ □ > button to select an album, then press <Q/SET>.
- Select [OK] on the dialog screen, then press <Q/SET>.
- ▶ Certain video snapshot settings will change to match the existing album's settings.
- Press the <MENU> button to exit the menu and return to the movie shooting screen.

3 Shoot the video snapshot.

- Go to "Creating a Video Snapshot Album" (p.191).



You cannot select an album shot with another camera.

⚠ Cautions for Shooting Video Snapshots

- You can add to an album only video snapshots with the same duration (approx. 2 sec., 4 sec., or 8 sec. each).
- Note that if you do any of the following while shooting video snapshots, a new album will be created for subsequent video snapshots.
 - Changing the [Movie rec. size] (p.187).
 - Changing the [Sound rec.] setting from [Auto] or [Manual] to [Disable] or from [Disable] to [Auto] or [Manual] (p.197).
 - Updating the firmware.
- You cannot take still photos while shooting a video snapshot.
- The shooting duration of a video snapshot is only approximate. Depending on the frame rate, the shooting duration displayed during playback may not be exact.

Playing an Album

You can play back a completed album in the same way as a normal movie (p.239).



1 Play back the movie.

- Press the <▶> button to display images.



2 Select the album.

- Press the <◀ * >/>▶> button to select an album.
- On the single-image display, the [▶] icon displayed on the upper left indicates that the image is a video snapshot.

3 Play back the album.

- Tap the [▶] (Play) icon at the center of the screen or tap the [▶] and then tap the [▶] (Play) icon on the movie playback panel that appears.

Editing an Album

After shooting, you can rearrange, delete, or play back the video snapshots in the album.



1 On the playback panel, select [X] (Edit).

- ▶ The editing screen will be displayed.



2 Select an editing operation.

- Tap the icon of the editing operation or press the <◀ * >/<▶ ☒ > button to select an editing operation, then press <Q/SET >.

Function	Description
↔ Move snapshot	Tap the video snapshot you want to move or press the <◀ * >/<▶ ☒ > button to select the video snapshot you want to move, then press <Q/SET >. Press the <◀ * >/<▶ ☒ > button to move the snapshot to the desired location.
🗑 Delete snapshot	Tap the video snapshot you want to delete or press the <◀ * >/<▶ ☒ > button to select the video snapshot you want to delete, then press <Q/SET >. The [🗑] icon will be displayed on the selected video snapshot. Pressing <Q/SET > again will cancel the selection and [🗑] will disappear.
▶ Play snapshot	Tap the video snapshot you want to play or press the <◀ * >/<▶ ☒ > button to select the video snapshot you want to play, then press <Q/SET >.



3 Save the edited album.

- Press the <MENU> button to return to the Editing panel at the screen's bottom.
- Tap the [] (Save) icon or press the <◀ * >/▶ > button to select [] (Save), then press <Q/SET >.
- ▶ The save screen will appear.
- To save it as a new movie, select [**New file**]. To save it and overwrite the original movie file, select [**Overwrite**], then press <Q/SET >.



Background Music

- Music recorded on the memory card must be used only for private enjoyment. Do not violate the rights of the copyright holder.
- You can play background music when you play back albums, normal movies, and slide shows on the camera (p.240, 243). To play background music, you must first copy the background music to the card using EOS Utility (provided software). For information on how to copy the background music, refer to the PDF Software Instruction Manual on the DVD-ROM.

Provided Software Usable with Albums

- **EOS Video Snapshot Task:** You can edit video snapshot albums. This add-on function for ImageBrowser EX is automatically downloaded from the Internet using the auto update function.

MENU Movie Menu Function Settings

When you set the Mode Dial to <[M]>, the [M 1] tab will show functions dedicated to movie shooting. The menu options are as follows.

[M 1] menu

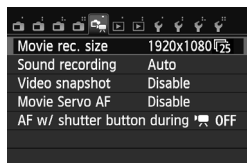

- **Movie recording size**

You can set the image size and frame rate. For details, see pages 187-188.

- **Sound recording**

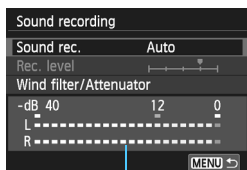

Level meter

Normally, the built-in microphone will record stereo sound. If a commercially-available microphone equipped with a mini plug (3.5 mm diameter) is connected to the camera's external microphone IN terminal (p.22), it will be given priority.

[Sound rec./Rec. level] options

- [Auto]** : The sound-recording level is adjusted automatically. Auto level control will operate in response to the sound level.

[Manual] : For advanced users. You can adjust the recording level manually.
 Select **[Rec. level]** and while looking at the level meter, press the <◀ * ▶/>▶ [X] > button to adjust. The loudest sound will be displayed for approx. 3 sec. Adjust so that the level meter on the right of “12” lights up occasionally. If the level meter lights up near “0”, the sound may be distorted.

[Disable] : Sound is not recorded.

[Wind filter]

When set to **[Enable]**, it reduces wind noise when there is wind outdoors. This feature takes effect only with the built-in microphone.

Note that **[Enable]** will also reduce low bass sounds, so set this function to **[Disable]** when there is no wind. It will record a more natural sound than with **[Enable]**.

[Attenuator]

Even if you set **[Sound recording]** to **[Auto]** or **[Manual]** and shoot, sound distortion may still result if there is a very loud sound. In such a case, setting it to **[Enable]** is recommended.

-  ● The sound volume balance between L (left) and R (right) cannot be adjusted.
- Both L and R record audio at a 48 kHz/16-bit sampling rate.



● **Video snapshot**

You can shoot video snapshots. For details, see page 189.

● Movie Servo AF

The default setting is **[Enable]**. You can focus by pressing the shutter button halfway regardless of the setting.

• When **[Enable]** is set:

- You can shoot a movie while focusing a moving subject continuously. Note that the camera may record the lens operation noise. To reduce the recording of the lens operation noise, use a commercially-available external microphone. Using the EF-S 18-135mm f/3.5-5.6 IS STM or EF-M 18-55mm f/3.5-5.6 IS STM lens will minimize the focusing noise during movie shooting.
- When using the Mount Adapter EF-EOS M, during Movie Servo AF, turn off the power before you set the lens's focus mode switch to **<MF>**.
- If **[AF w/ shutter button during  : Disable]** is set, pressing the shutter button halfway during movie shooting will not refocus.
- Since using Movie Servo AF will consume battery power, the number of possible shots and the possible movie shooting time will be reduced.
- If you magnify the image, the Movie Servo AF will stop.
- If you want to hold the focus at a certain point or avoid recording the lens operation noise before or during movie shooting, you can temporarily stop Movie Servo AF by performing one of the operations below. When you stop Movie Servo AF, the AF point will turn gray. When you perform the same operation again, Movie Servo AF will resume.
 - Tap the  icon on the lower left of the screen.
 - If **[5: Shutter/AE lock button]** is set to **[2: AF/AF lock, no AE lock]** in the **[4: Custom Functions (C.Fn)]**, Movie Servo AF will stop while you hold down the **<◀ * >** button. When you let go of the **<◀ * >** button, Movie Servo AF will resume.
- When you press the **<MENU>** or **<□>** button, change the AF method, or operate the lens focus mode, Movie Servo AF is stopped. It will resume when you return to movie shooting.

• When **[Disable]** is set:

- You can focus only when the shutter button is pressed halfway.

● **AF with shutter button during  (movie recording)**

When you press the shutter button while shooting a movie, you can shoot a still photo. The default setting is **[ONE SHOT]**.

• **When [ONE SHOT] is set:**

- You can refocus and shoot a still photo by pressing the shutter button halfway while shooting a movie.
- When shooting a static subject (not moving), you can take a picture with precise focus.

• **When [Disable] is set:**

- You can immediately start shooting a still photo by pressing the shutter button, even though focus is not achieved. It is effective when you want to give priority to the shutter chance rather than to focus.

Movie Shooting Cautions

Internal Temperature Warning (in white) or (in red)

- After prolonged shooting or when shooting under a high ambient temperature, the camera's internal temperature will increase and the white icon or red icon will appear in white or red on the screen.
- The white icon indicates degraded still photo quality. It is recommended to temporarily stop shooting still photos until the camera's internal temperature decreases. As the image quality of movies is almost unaffected, you can continue shooting movies.
- The red icon indicates that the power will soon turn off automatically. If this happens, you will not be able to shoot again until the camera's internal temperature decreases. Turn off the power and let the camera rest for a while.
- Shooting for prolonged periods under high ambient temperatures will cause the icon or icon to appear earlier. When you are not shooting, turn off the camera.

Recording and Image Quality

- If the attached lens has an Image Stabilizer and you set the Image Stabilizer (IS) to <ON>, the Image Stabilizer will operate at all times even if you do not press the shutter button halfway. The Image Stabilizer consumes battery power and may shorten the total movie shooting time or decrease the number of possible shots. If you use a tripod or if the Image Stabilizer is not necessary, it is recommended to set the IS to <OFF>.
- The camera's built-in microphone will also pick up camera operation noise. Using a commercially-available external microphone can prevent (or reduce) these noises from being recorded.
- Do not connect anything other than an external microphone to the camera's external microphone IN terminal.
- If the brightness changes during autoexposure movie shooting, that part may look momentarily still when you play back the movie. In such cases, shoot movies with manual exposure.
- If you use a card with a slow writing speed, a five-level indicator may appear on the right of the screen during movie shooting. It indicates how much data has not yet been written to the card (remaining capacity of the internal buffer memory). The slower the card, the faster the indicator will climb upward. If the indicator becomes full, movie shooting will stop automatically. If the card has a fast writing speed, the indicator will either not appear or the level (if displayed) will hardly go upward. First, shoot a few test movies to see if the card can write fast enough.

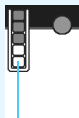

Indicator

Movie Shooting Cautions

Still Photo Shooting During Movie Shooting

- Regarding the image quality of still photos, see “Image Quality” on page 128.
- If the shutter button is pressed halfway to focus while shooting movies, you may experience the following irregularities.
 - The image may go temporarily out of focus.
 - A sudden change of brightness may be recorded in the movie.
 - A momentary stop may be recorded in the movie.
 - The operation sound of the lens may be picked up and recorded.
 - When the camera cannot focus, for example because the subject is moving, etc., shooting still photos may not be possible.

Connecting to a TV

- If you connect the camera to a TV set (p.247, 251) and shoot a movie, the TV will not output any sound during the shooting. However, the sound will be properly recorded.

Cautions when [Movie servo AF] is set to [Enable]

Shooting conditions that make focusing difficult

- A fast-moving subject approaching or moving away from the camera.
- A subject moving at a close distance in front of the camera.
- Also refer to “Shooting conditions that make focusing difficult” on page 123.
- Since using Movie Servo AF will consume battery power, the number of possible shots and the possible movie shooting time will be reduced.
- During zooming or image magnification, Movie Servo AF operation will be stopped momentarily.
- **During movie shooting, if a subject approaches / moves away, or if the camera is moved vertically or horizontally (panning) the recorded movie image may momentarily expand or contract (change in image magnification).**



The EOS M gives you room to grow as a photographer and learn new creative techniques. As you become more confident, explore semi-automatic and manual shooting modes that allow you to control how light enters the camera. Experiment and enjoy discovering how photography works.

6

Handy Features

- Disabling the Beeper (p.204)
- Card Reminder (p.204)
- Setting the Image Review Time (p.205)
- Displaying the Grid (p.205)
- Setting Power-saving Features (LCD auto off, Camera auto off) (p.206)
- Adjusting the LCD Monitor Brightness (p.207)
- Creating and Selecting a Folder (p.208)
- File Numbering Methods (p.210)
- Setting Copyright Information (p.212)
- Auto Rotation of Vertical Images (p.214)
- Checking Camera Settings (p.215)
- Reverting the Camera to the Default Settings (p.216)
- Changing the Shooting Settings Screen Color (p.219)
- Setting Speedlite Functions (p.220)
- Automatic Sensor Cleaning (p.225)
- Appending Dust Delete Data (p.227)

Handy Features

MENU Disabling the Beeper

You can prevent the beeper from sounding when focus is achieved, during self-timer operation, and during touch screen operations.

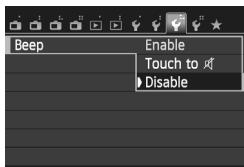

Under the [**F3**] tab, select [**Beeper**], then press <[**Q**]/SET>. Select [**Disable**], then press <[**Q**]/SET>.

To silence the beeper only during touch screen operations, select [**Touch to** ].

MENU Card Reminder

This setting prevents shooting if there is no card in the camera.

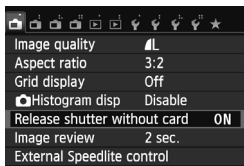

Under the [**1**] tab, select [**Release shutter without card**], then press <[**Q**]/SET>. Select [**Disable**], then press <[**Q**]/SET>.

If there is no card inserted in the camera and you press the shutter button, “**No card in camera**” will be displayed on the LCD monitor, and you cannot release the shutter.

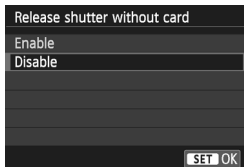

MENU Setting the Image Review Time

You can change how long the image is displayed on the LCD monitor immediately after capture. If **[Off]** is set, the image will not be displayed immediately after image capture. If **[Hold]** is set, the image review will be displayed up until the **[LCD auto off]** time.

During image review, if you operate anything such as pressing the shutter button halfway, the image review will end.

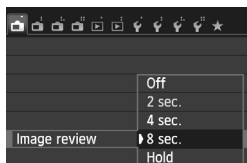

Under the **[📷 1]** tab, select **[Image review]**, then press **<Q/SET>**. Select the desired setting, then press **<Q/SET>**.

MENU Displaying the Grid

By displaying a grid on the LCD monitor, you can check the picture for any horizontal or vertical tilt. Two grid patterns are provided.

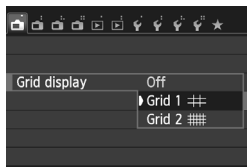

Under the **[📷 1]** tab, select **[Grid display]**, then press **<Q/SET>**. Select either **[Grid 1 3x3]** or **[Grid 2 4x4]**, then press **<Q/SET>**.



MENU Setting Power-saving Features (LCD auto off, Camera auto off)

If you do not operate the camera for a while, the LCD monitor will turn off automatically to save power. If you further leave the camera alone, the camera's power will turn off automatically. You can set the time until when the LCD monitor turns off and when the camera's power turns off automatically.

If the LCD monitor has turned off to save power, pressing any camera button or tapping the LCD monitor will turn it on again.

If the camera's power has turned off to save power, you can turn it on again by pressing the power button or hold down the <▶> button for at least 2 sec.

The Power/access lamp will blink when you set the power to <ON> and turns off when you are using power. When the LCD monitor turns off, the Power/access lamp will turn green.

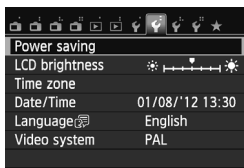

Under the [**⚡**] tab, select [**Power saving**], then press <[**Q**]/SET>. Select the desired setting for [**LCD auto off**] and [**Camera auto off**], then press <[**Q**]/SET>.

[**Camera auto off**] is the auto off time after the LCD monitor turns off.

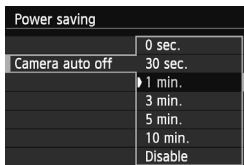
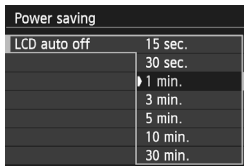

MENU Adjusting the LCD Monitor Brightness

You can adjust the brightness of the LCD monitor to make it easier to read. You can either use the menu to set the brightness level or set the Custom Function to make it brighter temporarily.

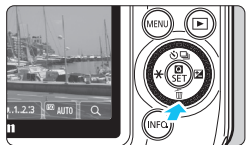
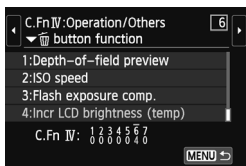
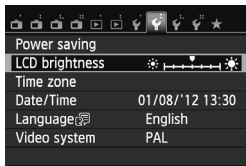

Adjusting the brightness with the menu

Under the [**F2**] tab, select [**LCD brightness**], then press <**Q**/SET>. On the adjustment screen, tap [**◀**]/[**▶**] or press the <**◀ * >**/<**▶ □**> button to adjust the brightness. Then press <**Q**/SET>.

When checking the exposure of an image, set the LCD monitor brightness to 4 and prevent the ambient light from affecting the reviewed image.

If you use the Custom Function to set [**Incr LCD brightness (temp)**] (p.287) to the <**▼**  > button, it will be the same brightness as level “7” set with the menu. Press the button again and it will return to the previous brightness.

If the power is turned <OFF> or the brightness adjustment screen is displayed with the menu, the brightness will be set to the previous level.

MENU Creating and Selecting a Folder

You can freely create and select the folder where the captured images are to be saved.

This operation is optional since a folder will be created automatically for saving captured images.

Creating a Folder

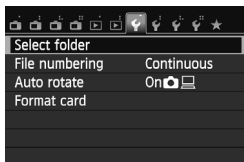

1 Select [Select folder].

- Under the [**1**] tab, select [**Select folder**], then press <**Q**/SET >.

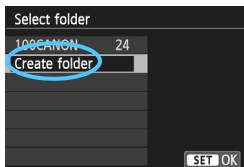

2 Select [Create folder].

- Select [**Create folder**], then press <**Q**/SET >.

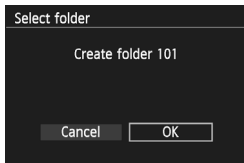

3 Create a new folder.

- Select [**OK**], then press <**Q**/SET >.
- ▶ A new folder with the folder number increased by one is created.

Selecting a Folder

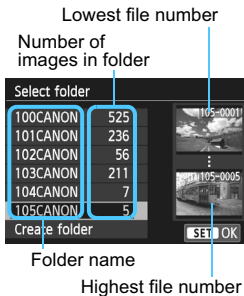

- With the folder selection screen displayed, select a folder and press **<Q/SET>**.
- Subsequent captured images will be recorded into the selected folder.

About Folders

As with “100CANON” for example, the folder name starts with three digits (folder number) followed by five alphanumeric characters. A folder can contain up to 9999 images (file number 0001 - 9999). When a folder becomes full, a new folder with the folder number increased by one is created automatically. Also, if manual reset (p.211) is executed, a new folder will be created automatically. Folders numbered from 100 to 999 can be created.

Creating Folders with a Personal Computer

With the card open on the screen, create a new folder named “DCIM”. Open the DCIM folder and create as many folders as necessary to save and organize your images. The folder name must follow the format “100ABC_D”. The first three digits are the folder number, from 100 to 999. The next five characters can be any combination of upper- and lower-case letters from A to Z, numerals, and the underscore “_”. The space cannot be used. Also, the camera cannot recognize folders having the same folder number even if the last five characters are different, such as 100ABC_D and 100W_XYZ.

MENU File Numbering Methods

The image files will be numbered from 0001 to 9999 in the order the images are taken, then saved in a folder. You can change how the file number is assigned.

The file number will appear on your computer in this format:

IMG_0001.JPG.

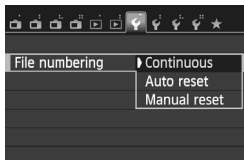

Under the [**1**] tab, select [**File numbering**], then press <**Q**/SET>. The available settings are described below. Select one, then press <**Q**/SET>.

- **[Continuous]: The file numbering continues in sequence even after you replace the card or create a folder.**

Even after you replace the card or create a new folder, the file numbering continues in sequence up to 9999. This is convenient when you want to save images numbered anywhere between 0001 to 9999 in multiple cards or folders into one folder in your personal computer.

If the replacement card or existing folder already contains images recorded previously, the file numbering of the new images may continue from the file numbering of the existing images in the card or folder. If you want to use continuous file numbering, it is recommended that you use a newly-formatted card each time.

File numbering after replacing the card

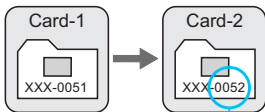

Next sequential file number

File numbering after creating a folder

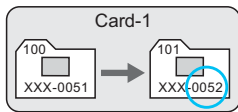

- **[Auto reset]: The file numbering restarts from 0001 each time the card is replaced or a new folder is created.**

When you replace the card or create a folder, the file numbering restarts from 0001 for the new images saved. This is convenient if you want to organize images by cards or folders.

However, if the replacement card or existing folder already contains images recorded previously, the file numbering of the new images may continue from the file numbering of the existing images in the card or folder. If you want to save images with the file numbering starting from 0001, use a newly formatted card each time.

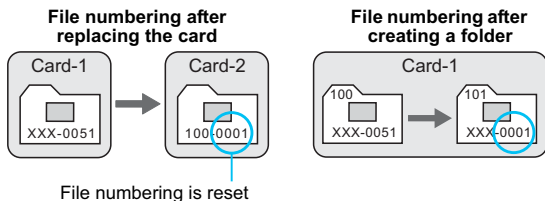

- **[Manual reset]: To reset the file numbering to 0001 manually or to start from file number 0001 in a new folder.**

When you reset the file numbering manually, a new folder is created automatically and the file numbering of images saved to that folder starts from 0001.

This is convenient if you want to use different folders for the images taken yesterday and the ones taken today, for example. After the manual reset, the file numbering returns to continuous or auto reset. (There will be no Manual reset confirmation screen.)



If the file number in folder 999 reaches 9999, shooting will not be possible even if the card still has storage capacity. The LCD monitor will display a message telling you to replace the card. Replace it with a new card.



For both JPEG and RAW images, the file name will start with "IMG_". Movie file names will start with "MVI_". The extension will be ".JPG" for JPEG images, ".CR2" for RAW images, and ".MOV" for movies.

MENU Setting Copyright Information ☆

When you set the copyright information, it will be appended to the image as Exif information.

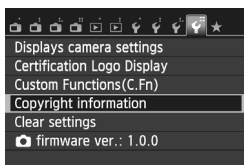
**1** Select [Copyright information].

- Under the [**4**] tab, select [**Copyright information**], then press <**Q**/SET>.

**2** Select the option to be set.

- Select [**Enter author's name**] or [**Enter copyright details**], then press <**Q**/SET>.
- ▶ The text entry screen will appear.
- Select [**Display copyright info.**] to check the copyright information currently set.
- Select [**Delete copyright information**] to delete the copyright information currently set.

**3** Enter text.

- Refer to "Text Entry Procedure" on the next page and enter the copyright information.
- Enter up to 63 alphanumeric characters and symbols.

4 Exit the setting.

- After entering the text, tap [**OK**].
- On the confirmation dialog, select [**OK**] and press <**Q**/SET>.

Text Entry Procedure



- **Changing the entry area:**
Press the <INFO.> button to toggle between the top and bottom entry areas.
- **Moving the cursor:**
Either tap [<]/[>] or press the < < * > / < * > > button to move the cursor.
- **Entering text:**
In the bottom area, type directly with the keyboard or turn the < < > > dial to select a character, then press < < Q / SET > to enter it.
- **Changing the entry mode:**
Tap [Aa=1@] at the bottom right of the bottom entry area. Each time you tap it, the entry mode will change as follows: Lower case → Numerals / Symbols 1 → Numerals / Symbols 2 → Upper case.
- **Deleting a character:**
Either tap [MENU / ^] or press the < MENU > button to delete one character.
- **Exiting:**
Tap [OK] to complete the text entry, and the screen in step 2 will reappear.
- **Canceling the text entry:**
Tap [Cancel] to cancel the text entry, and the screen in step 2 will reappear.

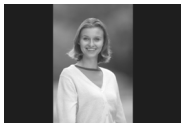

You can also set or check the copyright information with EOS Utility (provided software, p.340).

MENU Auto Rotation of Vertical Images

When you shoot a vertical image and view it with the camera or personal computer, it will be rotated automatically to the vertical orientation. You can change this setting.

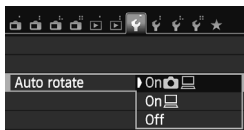

Under the [**1**] tab, select [**Auto rotate**], then press <**Q**/SET>. The available settings are described below. Select one, then press <**Q**/SET>.

- [**On**] : The vertical image is automatically rotated during playback on both the camera's LCD monitor and on the computer.
- [**On**] : The vertical image is automatically rotated only on the computer.
- [**Off**] : The vertical image is not automatically rotated.

? FAQ

- **The vertical image is not rotated during the image review immediately after it is captured.**

The image will be rotated when you press the < > button to play back images.

- **[On] is set, but the image does not rotate during playback.**
Auto rotate will not work with vertical images captured while [**Auto rotate**] was set to [**Off**]. If the vertical image is taken while the camera is pointed up or down, the image may not be rotated automatically for playback. In such a case, rotate the image with the procedure explained in "Rotating the Image" on page 233.
- **On the camera's LCD monitor, I want to rotate an image captured when [On] had been set.**
After you take the picture, you can still set [**On**] so that the image will be rotated during play back.
- **The vertical image does not rotate on the computer screen.**
The software used is not compatible with image rotation. Use the software provided with the camera instead.

MENU Checking Camera Settings

With the [4] tab's [Displays camera settings], you can check the major camera settings.

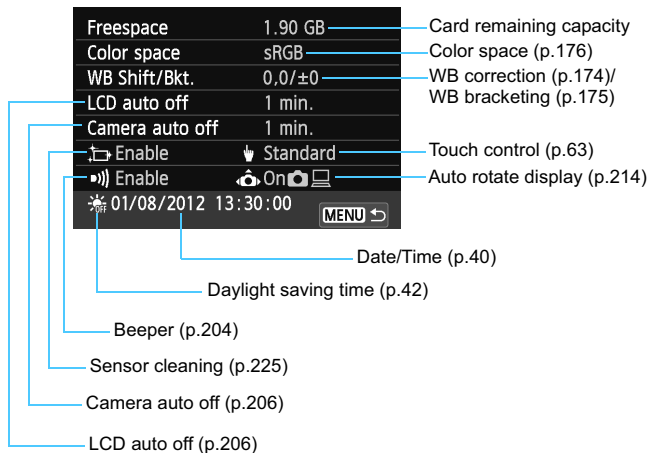
Settings display

MENU Reverting the Camera to the Default Settings ☆

In movie shooting mode or in one of the Creative Zone still photo shooting modes, the camera's shooting settings and menu settings can be reverted to their defaults. With this procedure, all settings in all shooting modes, including Scene Intelligent Auto, will revert to their default values.

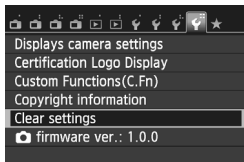
**1** Select [Clear settings].

- Under the [**4**] tab, select [**Clear settings**], then press <**Q**/SET>.

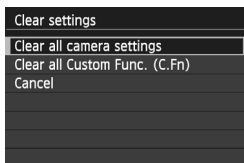
**2** Select [Clear all camera settings].

- Select [**Clear all camera settings**], then press <**Q**/SET>.

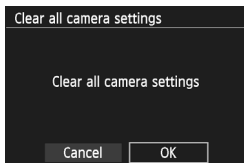
**3** Select [OK].

- Select [**OK**], then press <**Q**/SET>.
- ▶ Setting [**Clear all camera settings**] will reset the camera to the default settings as shown on the next page.

? FAQ● **Clearing all camera settings:**

Before the procedure above, select [**Clear all Custom Func. (C.Fn)**] in [**4: Clear settings**] to clear all the Custom Function settings (p.282).

Still Photo Shooting Settings





Shooting mode	 (Creative Auto)
AF operation	One-Shot AF
Drive mode	 (Single shooting)
Metering mode	 (Evaluative metering)
ISO speed	AUTO (Auto)
ISO Auto	Maximum 6400
Exposure compensation	Canceled
AEB	Canceled
Flash exposure compensation	0 (Zero)
Custom Functions	Unchanged
External Speedlite control	Unchanged















Image-recording Settings

Image quality	 L
Picture Style	Auto
Auto Lighting Optimizer	Standard
Peripheral illumination correction	Enable/ Correction data retained
Chromatic aberration correction	Disable/ Correction data retained
Color space	sRGB
White balance	 (Auto)
Custom White Balance	Canceled
White balance correction	Canceled
White balance bracketing	Canceled
Long exposure noise reduction	Disable
High ISO speed noise reduction	Standard
File number	Continuous
Auto cleaning	Enable
Dust Delete Data	Erased



Regarding GPS settings, refer to the GPS unit's instruction manual.

Camera Settings

Camera auto off	1 min.
Beep	Enable
Release shutter without card	Enable
Image review	2 sec.
 Histogram display	Disable
 Histogram display	Brightness
Image jump with 	 (10 images)
Auto rotate	On  
LCD brightness	        
LCD auto off	1 min.
Time zone	Unchanged
Date/Time	Unchanged
Language	Unchanged
Video system	Unchanged
Screen color	1
Feature guide	Enable
Touch control	Standard
Copyright information	Unchanged
Control over HDMI	Disable
Eye-Fi transmission	Disable
My Menu settings	Unchanged
Display from My Menu	Disable
AF method	FlexiZone - Single
Continuous AF	Enable
Touch Shutter	Disable
Grid display	Off
Aspect ratio	3:2
Metering timer	16 sec.

Movie Shooting Settings

Shooting mode	Movie auto exposure
AF method	FlexiZone - Single
Movie Servo AF	Enable
AF with shutter button during 	ONE SHOT
Grid display	Off
Metering timer	16 sec.
Movie recording	1920x1080
Sound recording	Auto
Video snapshot	Disable

MENU Changing the Shooting Settings (INFO. Quick Control) Screen Color

You can change the background color of the shooting settings screen.

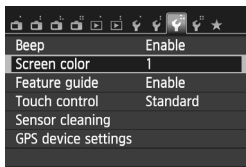

Under the [**F3**] tab, select [**Screen color**], then press <[**Q**]/SET>. Select the desired color, then press <[**Q**]/SET>.



MENU Setting Speedlite Functions ☆

You can set Speedlite functions with the menu. **Applicable only to a compatible EX-series Speedlite when attached to the camera.**

The setting procedure is the same as that for setting a camera menu function.

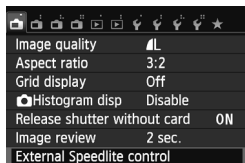

Select [External Speedlite control].

- Under the [1] tab, select [External Speedlite control], then press <Q/> SET >.
- ▶ The external Speedlite control screen will appear.

[Flash firing]

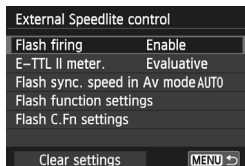

- Normally, set this to [Enable].
- If [Disable] is set, the external Speedlite will not fire. This is useful when you only want to use the flash's AF-assist beam.
- When using a Speedlite 90EX, if the shooting mode is <A+> (Scene Intelligent Auto), <P> (Portrait), <M> (Close-up) or <N> (Night Portrait), the flash will fire automatically regardless of this setting. If the shooting mode is <CA> (Creative Auto), you can select [Auto flash], [Flash on] or [Flash off] from the Quick Control screen.

[E-TTL II meter.]

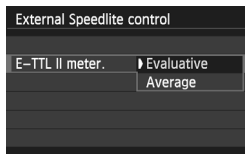

- For normal flash exposures, set this to [Evaluative].
- [Average] is for advanced users. As with an external Speedlite, the metering area is averaged. Flash exposure compensation may be necessary.

[Flash sync. speed in Av mode]

Flash sync. speed in Av mode	
Auto	AUTO
1/200-1/60sec. auto	$\frac{1}{200}$ - $\frac{1}{60}$ A
1/200 sec. (fixed)	1/200
SET OK	

You can set the flash-sync speed for flash photography in the aperture-priority AE (**Av**) mode.

- **AUTO: Auto**

The flash sync speed is set automatically within a range of 1/200 sec. to 30 sec. to suit the scene's brightness. High-speed sync is also possible.

- $\frac{1}{200}$ - $\frac{1}{60}$ A: **1/200-1/60 sec. auto**

Prevents a slow shutter speed from being set in low-light conditions. It is effective for preventing subject blur and camera shake. However, while the subject will be properly exposed with the flash, the background may come out dark.

- 1/200: **1/200 sec. (fixed)**

The flash-sync speed is fixed at 1/200 sec. This more effectively prevents subject blur and camera shake than with [**1/200-1/60 sec. auto**]. However, in low light, the subject's background will come out darker than with [**1/200-1/60 sec. auto**].



If [**1/200-1/60 sec. auto**] or [**1/200 sec. (fixed)**] is set, high-speed sync is not possible in the <**Av**> mode.

[Flash function settings]

You can set the functions in the table below. Note that the functions displayed will vary depending on the Speedlite model.

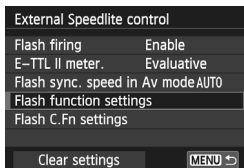

- Select **[Flash function settings]**.
- ▶ The flash functions will be displayed.

Sample screen

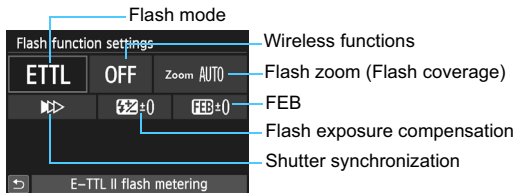

[Flash function settings]

[Flash function settings] Functions

Function	Page
Flash mode	223
Shutter synchronization	223
FEB*	
Wireless functions	223
Channel	
Flash group	
Flash exposure compensation	154
Flash zoom*	

* For **[FEB]** (Flash exposure bracketing) and **[Flash zoom]**, refer to the Speedlite's instruction manual corresponding to each function.

● Shutter synchronization

Normally, set this to **[First-curtain synchronization]** so that the flash fires immediately after the exposure starts.

If **[Second-curtain synchronization]** is set, the flash will fire right before the shutter closes. When this is combined with a slow shutter speed, you can create a trail of light such as from car headlights at night. With 2nd curtain synchronization, two flashes will be fired: Once when you press the shutter button completely, and once immediately before the exposure ends. Also, with shutter speeds faster than 1/30 sec., 1st curtain synchronization will automatically take effect.

You can also select **[High-speed synchronization]** ($\frac{1}{2}H$). For details, refer to the Speedlite's instruction manual.

● Wireless functions

Wireless flash shooting with multiple Speedlites is possible with optical or radio transmissions. For details, see the wireless Speedlite's instruction manual (for Speedlite 90EX, etc.).

● Flash exposure compensation

See "Flash Exposure Compensation" on page 154.

● Flash mode

You can select the flash mode to suit your desired flash shooting.

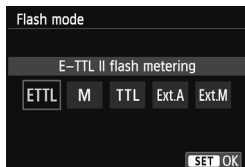

- **[E-TTL II flash metering]** is the standard mode of EX-series Speedlites for automatic flash shooting.
- **[Manual flash]** is for advanced users who want to set the **[Flash output level]** (1/1 to 1/128) themselves.
- Regarding other flash modes, refer to your Speedlite's instruction manual.

Setting the Speedlite Custom Functions

The Custom Functions displayed under [Flash C.Fn settings] will vary depending on the Speedlite model.

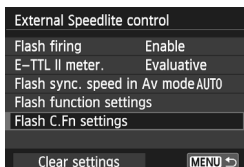

1 Display the Custom Function.

- With the camera ready to shoot with an external Speedlite, select [Flash C.Fn settings], then press <Q/SET>.

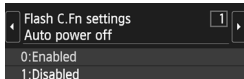

2 Set the Custom Function.

- Either tap [◀]/[▶] or press the <◀ * >/<▶ □ > button to select the number and set the function. The procedure is the same as setting the camera's Custom Functions (p.282).

Clear the Settings

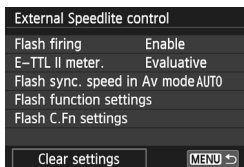

1 Select [Clear settings].

- Under the [📷 1: External Speedlite control] tab, select [Clear settings], then press <Q/SET>.

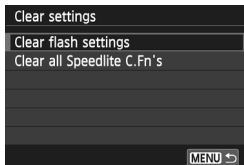

2 Select the settings to be cleared.

- Select [Clear flash settings] or [Clear all Speedlite C.Fn's], then press <Q/SET>.
- When you select [OK], the respective flash settings will be cleared.

Automatic Sensor Cleaning

When you switch the power to <ON> or <OFF> (or Camera auto off), the Self Cleaning Sensor Unit will operate automatically to remove dust on the image sensor. Normally, you need not pay attention to this operation. You can also activate or stop the Self Cleaning Sensor Unit when necessary.

Cleaning the Sensor Now

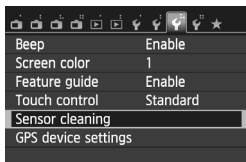

1 Select [Sensor cleaning].

- Under the [**3**] tab, select [**Sensor cleaning**], then press <**Q**/SET>.

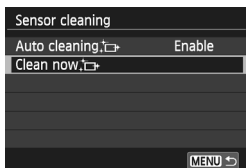

2 Select [Clean now].

- Select [**Clean now **], then press <**Q**/SET>.
- On the dialog screen, select [**OK**] and press <**Q**/SET>.
- ▶ The screen will indicate that the sensor is being cleaned. Although there will be a shutter sound, a picture is not taken.
- ▶ The sensor cleaning also works while no lens is attached. If no lens is attached, do not insert your finger or blower tip beyond the lens mount. This is to prevent damage to the shutter curtains.
- The camera will restart.



- For best results, perform the sensor cleaning with the camera placed upright and stable on a table or other flat surface.
- Even if you repeat the sensor cleaning, the result will not improve much. Immediately after the sensor cleaning is finished, the [**Clean now **] option will remain disabled temporarily.

Disabling Automatic Sensor Cleaning

- In step 2, select [Auto cleaning ] and set it to [Disable].

Manual Sensor Cleaning

Dust that could not be removed by the automatic sensor cleaning can be removed manually with a blower, etc. Before cleaning the sensor, detach the lens from the camera.

The surface of the image sensor is extremely delicate. If the sensor needs to be cleaned directly, having it done by a Canon Service Center is recommended.

- 1 Set the power to <OFF>.
- 2 Detach the lens.
- 3 Clean the sensor.
- 4 End the cleaning.

- The surface of the image sensor is extremely delicate. Clean the sensor with care.
- Use a plain blower without any brush attached. A brush can scratch the sensor.
- Do not insert the blower tip inside the camera beyond the lens mount. It can damage the shutter curtains.
- Never use canned air or gas to clean the sensor. The blowing force can damage the sensor or the spray gas can freeze on the sensor.
- If a smudge that cannot be removed with a blower remains, having the sensor cleaned by a Canon Service Center is recommended.

MENU Appending Dust Delete Data ☆

Normally, the Self Cleaning Sensor Unit will eliminate most of the dust that may be visible on captured images. However, in case visible dust still remains, you can append the Dust Delete Data to the image for erasing the dust spots later. The Dust Delete Data is used by Digital Photo Professional (provided software, p.340) to erase the dust spots automatically.

Preparation

- Prepare a solid white object such as a sheet of paper.
- Set the lens focal length to 50 mm or longer.
- Set the lens focus mode switch to <MF> and set the focus to infinity (∞). If the lens has no distance scale, look at the front of the lens and turn the focusing ring clockwise all the way.

Obtain the Dust Delete Data

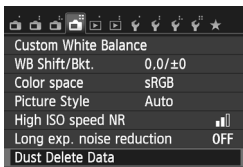

1 Select [Dust Delete Data].

- Under the [4] tab, select [Dust Delete Data], then press <Q/SET>.

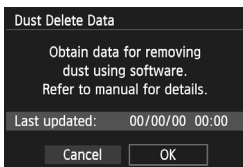

2 Select [OK].

- Select [OK] and press <Q/SET>. After the automatic self-cleaning of the sensor is performed, a message will appear. Although there will be a shutter sound during the cleaning, a picture is not taken.

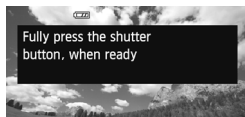
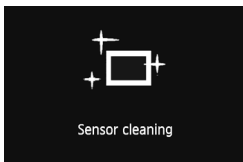

3 Photograph a solid-white object.

- At a distance of 20 cm - 30 cm (0.7 ft. - 1.0 ft.), fill the LCD monitor with a patternless, solid-white object and take a picture.
- ▶ The picture will be taken in aperture-priority AE mode at an aperture of f/22.
- Since the image will not be saved, the data can still be obtained even if there is no card in the camera.
- ▶ When the picture is taken, the camera will start collecting the Dust Delete Data. When the Dust Delete Data is obtained, a message will appear. Select [OK], and the menu will reappear.
- If the data was not obtained successfully, a message to that effect will appear. Follow the "Preparation" procedure on the preceding page, then select [OK]. Take the picture again.

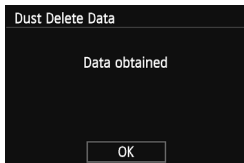

About the Dust Delete Data

After the Dust Delete Data is obtained, it is appended to all the JPEG and RAW images captured thereafter. Before an important shoot, it is recommended to update the Dust Delete Data by obtaining it again. For details about using Digital Photo Professional (provided software, p.340) to erase dust spots, refer to the PDF Software Instruction Manual on the DVD-ROM.

The Dust Delete Data appended to the image is so small that it hardly affects the image file size.

! Be sure to use a solid-white object such as a new sheet of white paper. If the paper has any pattern or design, it may be recognized as dust data and affect the accuracy of the dust deletion with the software.



There are lots of ways to enjoy your photography, from traditional prints to on-screen slideshows and social media. An HD-TV lets you share pictures with family and friends in your own home.

7

Image Playback

This chapter explains functions related to viewing photos and movies, in more detail than in Chapter 2 “Scene Intelligent Auto + Basic Zone Modes and Image Playback”. Here you will find explanations of how to play back and erase photos and movies with the camera and view them on a TV set.

About images shot and saved with another device

The camera may not be able to properly display images captured with a different camera, edited with a computer or whose file name was changed.

Playing Back with the Touch Screen

The LCD monitor is a touch-sensitive panel that you can touch with your fingers for playback operations. **Press the <▶> button to play back images.** (The last shot will appear first.)

If the power is off, you can hold down the <▶> button for 2 sec. or longer to turn on the camera and display the playback screen.

Browse Images

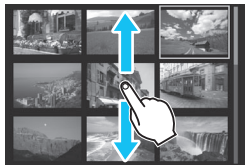

Swipe with one finger.

- With the single-image display, use **one finger** to swipe the image to the left or right to see another image. Swipe to the left to see the next (newer) image or swipe to the right to see the previous (older) image.
- With the index display of four or nine images, use **one finger** to scroll up or down the screen to display another screen of index images. Swipe your finger up to see newer images or swipe your finger down to see the older images. When you select an image and tap it, it will be displayed as a single image.

Jump through Images (Jump Display)

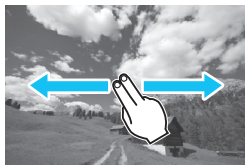

Swipe with two fingers.

When you use **two fingers** to swipe left or right on the screen, you can jump through images with the method set in [Image jump with 

Reduce Images (Index Display)



Pinch two fingers.

Touch the screen with two fingers spread apart, and pinch your fingers together on the screen.

- Each time you pinch your fingers, the screen changes from a single-image display to a 4-image index display and 9-image index display.
- The selected image on the index display is indicated in an orange frame.
- Movie images on the index display will have a vertical perforation.

Magnify Images



Spread two fingers apart.

Touch the screen with two fingers together, then spread your fingers apart on the screen.

- As you spread your fingers, the image will be magnified.
- The image can be magnified up to 10x.
- Tapping the [↶] icon on the screen's upper right will return to the single-image display.

Jumping through Images (Jump Display) ■

With the single-image display, you can turn the <⦿> dial to jump through the images forward or backward according to the jump method set.

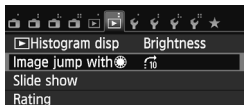

1 Select [Image jump with ⦿].

- Under the [▶2] tab, select [Image jump with ⦿], then press <Q/> SET>.



2 Select the jump method.

- Press the <▲⦿/▶>/<▼⦿>/<◀✳>/<▶☒> button to select the desired jump method, then press <Q/> SET>.

: Display images one by one

: Jump 10 images

: Jump 100 images

: Display by date

: Display by folder

: Display movies only

: Display stills only

: Display by image rating (p.234)



Jump method

Playback position

3 Browse by jumping.

- Press the <▶> button to play back images.
- On the single-image display, turn the <⦿> dial.



- To search images by the shooting date, select [Date].
- To search images by folder, select [Folder].
- If the card contains both movies and still photos, select [Movies] or [Stills] to display only either ones.
- If no images match the selected [Rating], [Stills] or [Movies], you cannot browse through the images with the <⦿> dial.

Rotating the Image

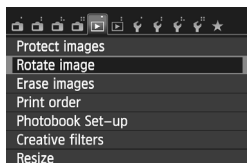
You can rotate the image for viewing.





1 Select [Rotate image].

- Under the [1] tab, select [**Rotate image**], then press </SET>.



2 Select an image.



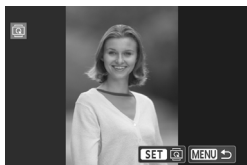

- Press the <</>> button to select the image to be rotated.
- You can also select an image on the index display (p.231).



3 Rotate the image.

- Each time you press </SET>, the image will rotate clockwise as follows: 90° → 270° → 0°.
- To rotate another image, repeat steps 2 and 3.
- To exit and return to the menu, press the <MENU> button.



- If you have set [**1: Auto rotate**] to [**On** ] (p.214) before taking vertical shots, you need not rotate the image as described above.
- If the rotated image is not displayed in the rotated orientation during image playback, set [**1: Auto rotate**] to [**On** ].
- A movie cannot be rotated.

MENU Setting Ratings

You can rate images and movies with one of five rating marks: [★]/[★★]/[★★★]/[★★★★]/[★★★★★]. This function is called rating.

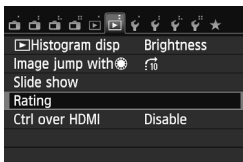

1 Select [Rating].

- Under the [▶2] tab, select [Rating], then press <Q/SET>.



2 Select an image.

- Press the <◀*>/<▶☒> button to select an image or movie to be rated.
- By touching the LCD monitor with two fingers spread apart and then pinching the fingers, a three-image display will appear. You can then select images. To return to the single-image display, touch the LCD monitor with two pinched fingers, then spread the fingers apart on the screen.



3 Rate the image or movie.

- Press the <▲☺/☐>/<▼☒> button to select a rating.
- ▶ The total number of images and movies rated will be counted for each rating.
- To rate another image or movie, repeat steps 2 and 3.
- Press the <MENU> button to return to the menu.



The total number of images with a given rating that can be displayed is 999. If there are more than 999 images with a given rating, [###] will be displayed for that rating.

Taking Advantage of Ratings

- With [▶2: **Image jump with** ], you can display only images and movies with a specific rating.
- With [▶2: **Slide show**], you can play back only images and movies with a specific rating.
- With Digital Photo Professional (provided software, p.340), you can select only still photos with a specific rating.
- With Windows 7 and Windows Vista, you can see each file's rating as part of the file information display or in the provided image viewer (still photos only).

Quick Control During Playback

During playback, you can press <Q/SET> to set any of the following: [On: **Protect images**], [Ⓜ: Rotate image], [★: **Rating**], [🌀: Creative filters], [📐: Resize] (JPEG images only), and [🏠: **Image jump with** 🕒].

For movies, only the functions in bold above can be set.

During playback, the Quick Control screen can be displayed only with **Q** Quick Control, and not with the INFO. button.

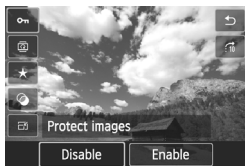

The procedure is the same as that for using the Quick Control screen in shooting mode. However, for Creative filters and Resize, you also press <Q/SET> to set them. For details, see page 260 for Creative filters and page 262 for Resize.



To rotate an image, set [🏠1: Auto rotate] to [On 📷 📐]. If [🏠1: Auto rotate] is set to [On 📐] or [Off], the [Ⓜ Rotate image] setting will be recorded to the image, but the camera will not rotate the image for display.

- Pressing <Q/SET> during the index display will switch to the single image display. Press <Q/SET> again to display the Quick Control screen.
- For images taken with another camera, the functions you can select may be limited.

Enjoying Movies

Playback on a TV set (p.247, 251)



Use the AV cable AVC-DC400ST or HDMI cable HTC-100 (both sold separately) to connect the camera to a TV set. Then you can play captured movies and still photos on the TV. If you have a High-Definition TV set and connect your camera with an HDMI cable, you can watch Full High-Definition (Full HD: 1920x1080) and High-Definition (HD: 1280x720) movies with higher image quality.

- Since hard disk recorders do not have an HDMI IN terminal, the camera cannot be connected to a hard disk recorder with an HDMI cable.
- Even if the camera is connected to a hard disk recorder with a USB cable, movies and still photos cannot be played or saved.
- If the TV has a card slot compatible with MOV files, you can play movies from the card inserted in the TV.

Playback on the Camera's LCD Monitor (p.239-246)

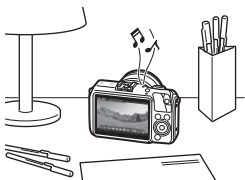

You can play back movies on the camera's LCD monitor. You can also edit out the movie's first and last scenes, and play back the still photos and movies on the card in an automatic slide show.

- This camera may not be able to play back movies recorded using other devices.
- A movie edited with a personal computer cannot be rewritten to the card and played back with the camera. However, video snapshot albums edited with EOS Video Snapshot Task (p.196) can be played on the camera.

Playback and Editing with a Personal Computer (p.340)



The movie files recorded on the card can be transferred to a personal computer and played or edited with ImageBrowser EX (provided software).

- To have the movie play back smoothly on a personal computer, use a high-performance personal computer. Regarding the computer hardware requirements for ImageBrowser EX, refer to the PDF file ImageBrowser EX User Guide.
- If you want to use commercially-available software to play back or edit the movies, be sure it is compatible with MOV files. For details on commercially-available software, contact the software manufacturer.

▶ Playing Movies



1 Play back the image.

- Press the <▶> button to display images.



2 Select a movie.

- Press the <◀ * >/<▶ □> button to select a movie.
- On the single-image display, the <▶ □> icon displayed on the upper left indicates a movie. If the movie is a video snapshot, <▶ □> will be displayed.
- You can press the <INFO.> button to switch to the shooting information display (p.257).



- In the index display, perforations at the left edge of a thumbnail indicate a movie. **As movies cannot be played on the index display, press <Q/SET> to switch to the single-image display.**

3 In the single-image display, press <▶ □>.

- ▶ The movie playback panel will appear at the bottom of the screen.







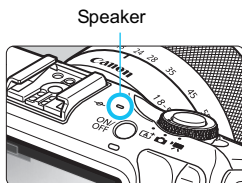





4 Play back the movie.

- Select [▶] (Play), then press <Q/SET>.
- ▶ The movie will start playing.
- You can pause the movie playback by pressing <Q/SET>.
- During movie playback, you can turn the <◉> dial to adjust the built-in speaker's sound volume.
- For more details on the playback procedure, see the next page.



Movie Playback Panel



Operation	Playback Description
▶ Play	Pressing <  /SET > toggles between play and stop.
▶ Slow motion	Adjust the slow motion speed by pressing the <  * > / <  > button. The slow-motion speed is indicated at the upper right of the screen.
⏪ First frame	Displays the movie's first frame.
⏮ Previous frame	Each time you press <  /SET >, the previous frame is displayed. If you hold down <  /SET >, it will rewind the movie.
⏭ Next frame	Each time you press <  /SET >, the movie will play frame-by-frame. If you hold down <  /SET >, it will fast forward the movie.
⏩ Last frame	Displays the movie's last frame.
✂ Edit	Displays the editing screen (p.241).
🎵 Background music*	Play back a movie with the selected background music (p.246).
	Play back position
mm' ss"	Playback time (minutes:seconds)
🔊 Volume	You can adjust the built-in speaker's (p.239) volume by turning the <  > dial.
MENU 	Returns to the single-image display.

* When background music is set, the movie's sound will not be played.

Playback with the Touch Screen



Tap [] at the center of the screen.

- ▶ The movie will start playing.
- To display the movie playback panel, tap <   > on the upper left of the screen.
- To pause the movie while it is playing, tap the screen. The movie playback panel will also appear.

- With a fully-charged Battery Pack LP-E12, the continuous playback time at 23°C/73°F will be as follows: approx. 2 hr. 20 min.
- If you took a still photo while you shot the movie, the still photo will be displayed for approx. 1 sec. during the movie playback.

✂ Editing a Movie's First and Last Scenes

You can edit out the first and last scenes of a movie in 1-sec. increments (except for video snapshots).



- 1 On the movie playback screen, select [✂].

▶ The editing screen will be displayed.



- 2 Specify the part to be edited out.

- Select either [✂] (Cut beginning) or [□✂] (Cut end), then press <Q/SET>.
- Tap [◀|||]/[|||▶] to see the previous or next frame. Tap and hold down [◀|||]/[|||▶] to fast forward the frames.
- After deciding which part to edit out, press <Q/SET>. The portion highlighted in gray on the top of the screen is what will remain.



- 3 Check the edited movie.

- Select [▶] and press <Q/SET> to play the portion shown in gray.
- To change the editing, go back to step 2.
- To cancel the editing, press the <MENU> button, select [OK] on the confirmation dialog, then press <Q/SET>.

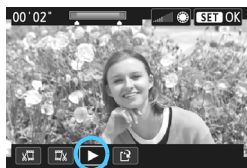

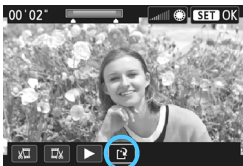

4 Save the edited movie.

- Select [**⏏**], then press <**Q**/SET>.
- ▶ The save screen will appear.
- To save it as a new movie, select [**New file**]. To save it and overwrite the original movie file, select [**Overwrite**], then press <**Q**/SET>.
- On the confirmation dialog, select [**OK**], then press <**Q**/SET> to save the edited movie and return to the movie playback screen.

- When the battery level is low, editing the movie is not possible. Use a fully-charged battery.
- Since the editing is performed in 1-sec. increments (position indicated by [**⏏**]), the exact position where the movie is edited may differ slightly from the position you specified.
- If the card does not have enough free space, [**New file**] will not be available.

MENU Slide Show (Auto Playback)

You can play back the images on the card as an automatic slide show.

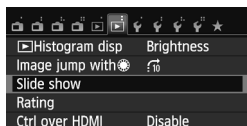

1 Select [Slide show].

- Under the [▶]2 tab, select [Slide show], then press <Q/SET>.

Number of images to be played

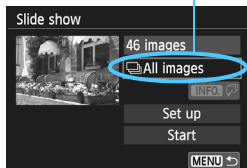

2 Select the images to be played from one of the following: [All images], [Movies], [Stills], [Date], [Folder], or [★ Rating].

- Set the option that appears as [All images] and is circled in the illustration. There are two ways to do so.

Select the [All images] option with the <▲📁/📁>/<▼🗑️> button

Press the <▲📁/📁>/<▼🗑️> button to select the [All images] option and then press <Q/SET>. Press the <▲📁/📁>/<▼🗑️> button to select the images to be played and then press <Q/SET>.

Tap directly the [All images] option

Tap the [All images] option twice. The following six options will then appear and you can select any of them: [All images], [Movies], [Date], [Stills], [Folder], [Rating]. Tap the images to be played and then tap [SET OK]. Back in the slide show settings screen, tap [MENU ↩].



[Date], [Folder], or
[Rating]

- Select the date, folder, or rating of the images to be played.
- When < **INFO** > is highlighted, press the <INFO.> button.
- Select the desired option, then press < /SET >.

[Date]



[Folder]

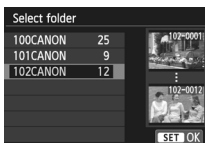

[Rating]

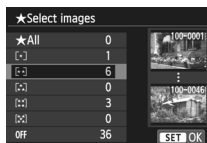

Item	Playback Description
All images	All the still photos and movies on the card will be played back.
Date	Still photos and movies taken on the selected shooting date will be played back.
Folder	Still photos and movies in the selected folder will be played back.
Movies	Only the movies on the card will be played back.
Stills	Only the still photos on the card will be played back.
Rating	Only the still photos and movies with the selected rating will be played back.

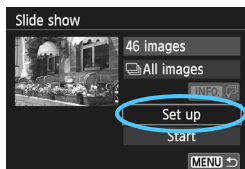

3 Set [Set up] as desired.

- Select [Set up], then press < /SET >.
- Set the [Display time], [Repeat], [Transition effect], and [Background music] for the still photos.
- The background music selection procedure is explained on page 246.
- After selecting the settings, press the <MENU> button.

[Display time]

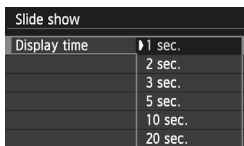

[Repeat]

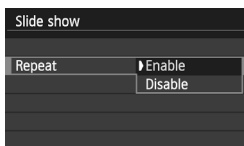

[Transition effect]

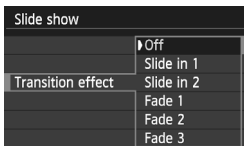

[Background music]

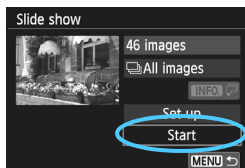
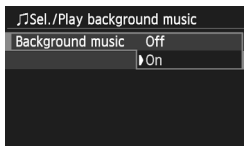

4 Start the slide show.

- Select [Start], then press <Q/SET>.
- ▶ After [Loading image...] is displayed, the slide show will start.

5 Quit the slide show.

- To quit the slide show and return to the setting screen, press the <MENU> button.



- To pause the slide show, press <Q/SET>. During pause, [III] will be displayed on the upper left of the image. Press <Q/SET> again to resume the slide show. You can also pause the slide show by tapping the screen.
- During the slide show, you can press the <INFO.> button to change the still photo display format (p.98).
- During movie playback, you can adjust the sound volume by turning the <◉> dial.
- During the slide show or during pause, you can press the <◀*>/<▶☒> button to view another image.
- During the slide show, auto power off will not work.
- The display time may vary depending on the image.
- To view the slide show on a TV set, see page 247.

Selecting the Background Music



1 Select [Background music].

- Set [Background music] to [On], then press <Q/SET>.

2 Select the background music.

- Press the <▲🎵/📄>/<▼🗑️> button to select the background music, then press <Q/SET>. You can also select multiple background music tracks.

3 Play the background music.

- To listen to a sample of the background music, press the <INFO.> button.
- Press the <▲🎵/📄>/<▼🗑️> button to play another background music track. To stop listening to the background music, press the <INFO.> button again.
- Adjust the sound volume by turning the <🔊> dial.
- To delete background music from the card, tap [Delete].

 At the time of purchase, you cannot select background music with the camera. You must first use EOS Utility (provided software) to copy the background music to the card. For details, refer to the PDF Software Instruction Manual for EOS Utility on the DVD-ROM.

Viewing the Images on TV

You can view the still photos and movies on a TV set.



- Adjust the movie's sound volume with the TV set. The sound volume cannot be adjusted with the camera.
- Before connecting or disconnecting the cable between the camera and television, turn off the camera and TV set.
- Depending on the TV set, part of the image displayed may be cut off.

Connecting an HDMI Cable and Viewing on a TV

HDMI Cable HTC-100 (sold separately) is required.

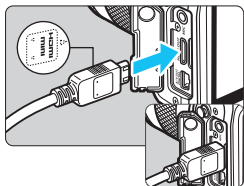

1 Connect the HDMI cable to the camera.

- With the plug's <▲HDMI MINI> side facing the front of the camera, insert it into the <HDMI OUT> terminal.

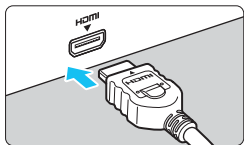

2 Connect the HDMI cable to the TV set.

- Connect the HDMI cable to the TV's HDMI IN port.

3 Turn on the TV and switch the TV's video input to select the connected port.

4 Set the camera's power to <ON>.

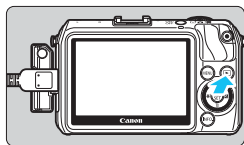

5 Press the <▶> button.

- ▶ The image will appear on the TV screen. (Nothing will be displayed on the camera's LCD monitor.)
- The images will automatically be displayed at the TV's optimum resolution.
- By pressing the <INFO.> button, you can change the display format.
- To play back movies, see page 239.

 The images cannot be output at the same time from both the <HDMI OUT> and <A/V OUT> terminals.

-  ● Do not connect any other device's output to the camera's <HDMI OUT> terminal. Doing so may cause a malfunction.
- Certain TVs may not be able to play back the captured images. In such a case, use the AV cable AVC-DC400ST (sold separately) to connect to the TV.

When the camera is connected to a TV, the following operations cannot be performed:

- **During shooting:**
 - Moving the AF point
 - Magnifying/reducing the image
 - Switching Movie Servo AF ON/OFF during movie shooting
- **During movie playback:**
 - Quick Control

Using HDMI CEC TV Sets

If the TV set connected to the camera with an HDMI cable is compatible with HDMI CEC*, you can use the TV set's remote control for playback operations.

* An HDMI-standard function enabling HDMI devices to control each other so that you can control them with one remote control unit.

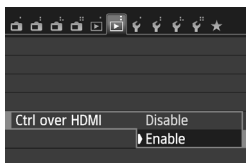

- 1 **Set [Ctrl over HDMI] to [Enable].**
 - Under the [**▶2**] tab, select [**Ctrl over HDMI**], then press <**Q**/SET>.
 - Select [**Enable**], then press <**Q**/SET>.

- 2 **Connect the camera to a TV set.**
 - Use an HDMI cable to connect the camera to the TV.
 - ▶ The TV's input will switch automatically to the HDMI port connected to the camera.

- 3 **Press the camera's <▶> button.**
 - ▶ An image will appear on the TV screen and you can use the TV's remote control to play back images.

- 4 **Select an image.**
 - Press the remote control's ←/→ button and select an image.

Still photo playback menu**Movie playback menu**

 : Return

 : 9-image index

 : Play movie

 : Slide show

INFO. : Disp. shooting info

 : Rotate

5 Press the remote control's Enter button.

- ▶ The menu appears and you can perform the playback operations shown on the left.
- Press the ←/→ button to select the desired option, then press the Enter button. For a slide show, press the remote control's ↑/↓ button to select an option, then press the Enter button.
- If you select **[Return]** and press the Enter button, the menu will disappear and you can use the ←/→ button to select an image.



- Some TV sets require you to first enable the HDMI CEC connection. For details, refer to the TV set's instruction manual.
- Certain TV sets, even those compatible with HDMI CEC, may not operate properly. In such a case, disconnect the HDMI cable, set **[▶] 2: Ctrl over HDMI** to **[Disable]**; then, connect the camera and TV once more using the HDMI cable and use the camera to control the playback operation.

Connecting an AV Cable and Viewing on a TV

If you use an AV cable to connect the camera to a TV, the playback will be in standard definition.

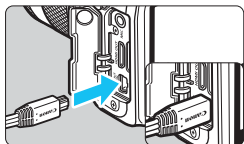

- 1 **Connect the AV cable AVC-DC400ST (sold separately) to the camera.**

- With the plug's <Canon> logo facing the back of the camera, insert it into the <A/V OUT> terminal.

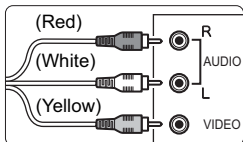

- 2 **Connect the AV cable to the TV set.**

- Connect the AV cable to the TV's video IN terminal and audio IN terminal.

- 3 **Turn on the TV and switch the TV's video input to select the connected port.**

- 4 **Set the camera's power to <ON>.**

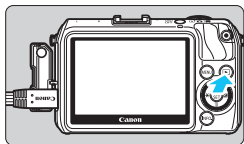

- 5 **Press the <▶> button.**

- ▶ The image will appear on the TV screen. (Nothing will be displayed on the camera's LCD monitor.)
- To play back movies, see page 239.

- ⓘ Do not use any AV cable other than AVC-DC400ST (sold separately). Images may not be displayed if you use a different cable.
- If the video system format does not match the TV's, the images will not be displayed properly. If this happens, switch to the proper video system format with [**2: Video system**].



Protecting Images

Protecting an image prevents it from being erased accidentally.

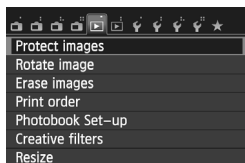
MENU Protecting a Single Image



1 Select [Protect images].

- Under the [ 1] tab, select [Protect images], then press </SET >.

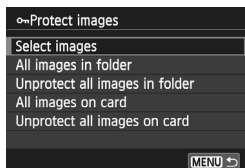

2 Select [Select images].







- Select [Select images], then press </SET >.

Image protect icon



3 Protect the image.

- Use the < * >/< * > button to select an image to be protected, then press </SET >.
- ▶ When an image is protected, the < > icon will appear on the top of the screen.
- To cancel the image protection, press </SET > again. The < > icon will disappear.
- To protect another image, repeat step 3.
- Press the <MENU> button to return to the screen in step 2.

MENU Protecting All Images in a Folder or on a Card

You can protect all the images in a folder or on a card at one time.

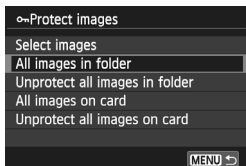

When you select **[All images in folder]** or **[All images on card]** in [**▶** 1: **Protect images**], all the images in the folder or on the card will be protected.

To cancel the image protection, select **[Unprotect all images in folder]** or **[Unprotect all images on card]**.

 **If you format the card (p.57), the protected images will also be erased.**

-  ● Movies can also be protected.
- Once an image is protected, it cannot be erased by the camera's erase function. To erase a protected image, you must first cancel the protection.
- If you erase all the images (p.255), only the protected images will remain. This is convenient when you want to erase unnecessary images all at once.

Erasing Images

You can either select and erase images one by one or erase them in one batch. Protected images (p.252) will not be erased.

- 1 **Once an image is erased, it cannot be recovered. Make sure you no longer need the image before erasing it. To prevent important images from being erased accidentally, protect them. Erasing a **RAW** + **L** image will erase both the RAW and JPEG images.**

Erasing a Single Image



- 1 **Play back the image to be erased.**

- 2 **Press the **<V>**  button.**

- ▶ The Erase menu will appear at the bottom of the screen.

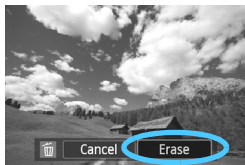

- 3 **Erase the image.**

- Select **[Erase]**, then press **<Q/SET>**. The image displayed will be erased.

MENU Checkmarking **<V>** Images to be Erased in a Batch

By appending checkmarks **<V>** to the images to be erased, you can erase multiple images at one time.

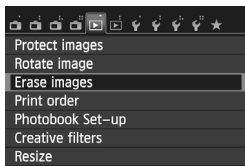

- 1 **Select **[Erase images]**.**

- Under the **[▶ 1]** tab, select **[Erase images]**, then press **<Q/SET>**.

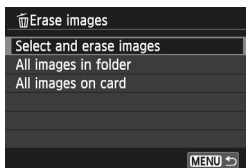

2 Select [Select and erase images].

- Select [**Select and erase images**], then press <[Q]/SET>.
- ▶ The images will be displayed.
- By touching the LCD monitor with two fingers spread apart and then pinching the fingers, a three-image display will appear. You can then select images. To return to the single screen, touch the LCD monitor with two pinched fingers, then spread the fingers.



3 Select the images to be erased.

- Press the <[X]>/<[Y]> button to select an image to be erased, then press <[Q]/SET>.
- ▶ A checkmark <✓> will be displayed on the upper left of the screen.
- To select other images to be erased, repeat step 3.

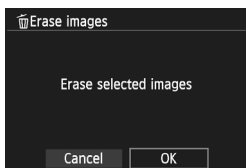

4 Erase the image.

- Press the <[V]> button.
- Select [**OK**], then press <[Q]/SET>.
- ▶ The selected images will be erased.

MENU Erasing All Images in a Folder or on a Card

You can erase all the images in a folder or on a card at one time. When [**1: Erase images**] is set to [**All images in folder**] or [**All images on card**], all the images in the folder or on the card will be erased.

 To also erase protected images, format the card (p.57).

INFO.: Shooting Information Display

Sample Image Taken in a Creative Zone Mode

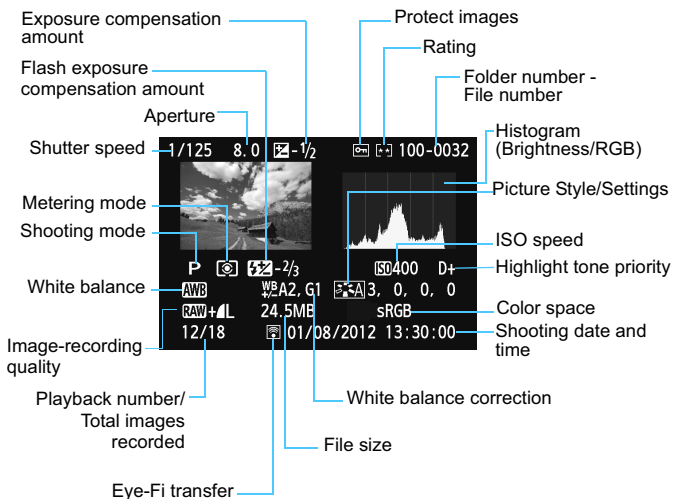

* With **RAW** + **L** images, the **RAW** file size is displayed.

* For still photos taken during movie shooting, **<M>** will be displayed.

* If a Creative filter or Resize has been applied to the image, the **<C>** icon will appear instead of the **<RAW +>** icon.

* Photos taken with flash without any flash exposure compensation are marked with the **<F>** icon. Photos taken with flash exposure compensation are marked with the **<FZ>** icon.

Sample Image Taken in a Basic Zone Mode

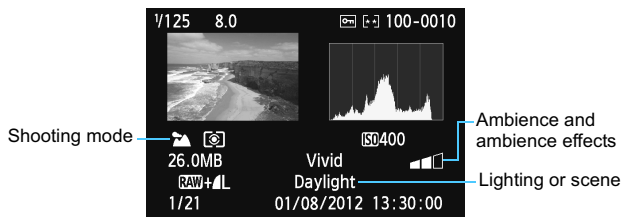

- * With images taken in the Scene Intelligent Auto or a Basic Zone mode, the information displayed will differ depending on the shooting mode.
- * Photos taken in the <CA> mode will show [Background blur].

Sample Movie

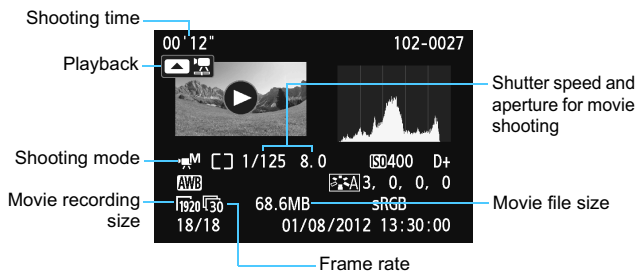

- * If manual exposure was used, the shutter speed, aperture, and ISO speed (when set manually) will be displayed.
- * The <[Snapshot Icon]> icon will be displayed for video snapshots.

● About the Highlight Alert

When the shooting information is displayed, any overexposed areas of the image will blink. To obtain more image detail in the overexposed areas, set the exposure compensation to a negative amount and shoot again.

● About the Histogram

The brightness histogram shows the exposure level distribution and overall brightness. The RGB histogram is for checking the color saturation and gradation. The display can be switched with [▶] 2: [▶] **Histogram disp.**

[Brightness] Display

This histogram is a graph showing the distribution of the image's brightness level. The horizontal axis indicates the brightness level (darker on the left and brighter on the right), while the vertical axis indicates how many pixels exist for each brightness level. The more pixels there are toward the left, the darker the image. The more pixels there are toward the right, the brighter the image. If there are too many pixels on the left, the shadow detail will be lost. If there are too many pixels on the right, the highlight detail will be lost. The gradation in-between will be reproduced. By checking the image and its brightness histogram, you can see the exposure level inclination and the overall gradation.

Sample Histograms



Dark image



Normal brightness



Bright image

[RGB] Display

This histogram is a graph showing the distribution of each primary color's brightness level in the image (RGB or red, green, and blue). The horizontal axis indicates the color's brightness level (darker on the left and brighter on the right), while the vertical axis indicates how many pixels exist for each color brightness level. The more pixels there are toward the left, the darker and less prominent the color. The more pixels there are toward the right, the brighter and denser the color. If there are too many pixels on the left, the respective color information will be lacking. If there are too many pixels on the right, the color will be too saturated with no gradation. By checking the image's RGB histogram, you can see the color's saturation and gradation condition, as well as white balance inclination.



Enhance and manipulate images in-camera using a range of built-in re-touching options.
No PC required!

8

Post-Processing Images During Playback

After shooting, you can apply Creative filters or resize the images (downsize the pixel count).



- The camera may not be able to process images taken with another camera.
- Post-processing images as described in this chapter cannot be performed while the camera is connected to a personal computer via the <DIGITAL> terminal.

Creative Filters

You can apply Creative filters even during image playback. An image applied with a Creative filter during playback can be saved as a new image, leaving the original image intact.

You can use the same Creative filters that are available during shooting (p.94).

You can also apply Creative filters with the  Quick Control screen.

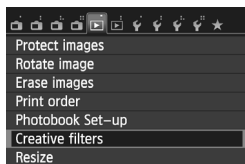

1 Select [Creative filters].

- Under the [▶ 1] tab, select [Creative filters], then press <Q/SET>.
- ▶ The images will be displayed.



2 Select an image.

- Select the image you want to apply a filter to.
- You can also select an image on the index display.

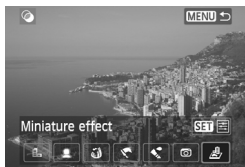

3 Select a filter.

- When you press <Q/SET>, the types of Creative filters will be displayed.
- For details on Creative filter characteristics, see pages 96, 97.
- Press the <◀ * >/<▶ ☒ > button to select a Creative filter, then press <Q/SET>.
- ▶ The image will be displayed with the corresponding filter applied.



4 Adjust the filter effect.

- Press the <◀ * >/<▶ □ > button to adjust the filter effect, then press <Q/SET >.
- For the Miniature effect, press the <▲ ⌚ /□ >/<▼ 🗑 > button and select the image area (within the white frame) where you want the image to look sharp. Then press <Q/SET >. By pressing the <INFO.> button, you can switch the white frame's orientation between vertical and horizontal.

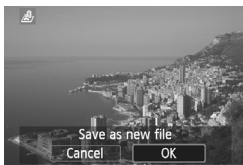

5 Save the image.

- Select [OK] to save the image.
- Check the destination folder and image file number, then select [OK].
- To apply a filter to another image, repeat steps 2 to 5.
- Press the <MENU> button to return to the menu.



When shooting **RAW** + **L** or **RAW** images, the Creative filter will be applied to the **RAW** image and the image will be saved as a JPEG image. If an aspect ratio is set for shooting a **RAW** image and a Creative filter is applied, the image will be saved in the aspect ratio that was set.



Resize

You can resize an image to make the pixel count lower and save it as a new image. Resizing an image is possible only with JPEG **L/M/S1/S2** images. **JPEG S3 and RAW images cannot be resized.**

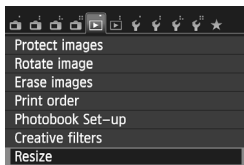
You can also resize with the  Quick Control screen.



1 Select **[Resize]**.

- Under the [] **1** tab, select **[Resize]**, then press /SET >.
- ▶ The images will be displayed.







2 Select an image.

- Select the image you want to resize.
- You can also select an image on the index display.



Target sizes

3 Select the desired image size.

- When you press /SET >, the image size will be displayed.
- Press the <  * > / <  > button to select the desired image size, then press /SET >.



4 Save the image.

- Select [OK] to save the resized image.
- Check the destination folder and image file number, then select [OK].
- To resize another image, repeat steps 2 to 4.
- Press the <MENU> button to return to the menu.

Resize Options According to Original Image Size

Original Image Size	Available Resize Settings			
	M	S1	S2	S3
L	<input type="radio"/>	<input type="radio"/>	<input type="radio"/>	<input type="radio"/>
M		<input type="radio"/>	<input type="radio"/>	<input type="radio"/>
S1			<input type="radio"/>	<input type="radio"/>
S2				<input type="radio"/>
S3				

About Image Sizes

The image size displayed in step 3 on page 262, such as [***M****x****], has a 3:2 aspect ratio. The image size according to aspect ratios is shown in the table below.

The asterisked image-recording quality figures do not exactly match the aspect ratio. The image will be cropped slightly.

Image Quality	Aspect Ratio and Pixel Count (Approx.)			
	3:2	4:3	16:9	1:1
M	3456x2304 (8.0 megapixels)	3072x2304 (7.0 megapixels)	3456x1944 (6.7 megapixels)	2304x2304 (5.3 megapixels)
S1	2592x1728 (4.5 megapixels)	2304x1728 (4.0 megapixels)	2592x1456* (3.8 megapixels)	1728x1728 (3.0 megapixels)
S2	1920x1280 (2.5 megapixels)	1696x1280* (2.2 megapixels)	1920x1080 (2.1 megapixels)	1280x1280 (1.6 megapixels)
S3	720x480 (350,000 pixels)	640x480 (310,000 pixels)	720x400* (290,000 pixels)	480x480 (230,000 pixels)



Printing your photography is a great way to show off your camera skills to friends and family.

From conventional prints to photo books and large-scale fine-art images, pictures from your EOS M will always impress.

9

Printing Images

- **Printing** (p.266)
You can connect the camera directly to a printer and print out the images on the card. The camera is compatible with “PictBridge” which is the standard for direct printing.
- **Digital Print Order Format (DPOF)** (p.275)
DPOF (Digital Print Order Format) enables you to print images recorded on the card according to your printing instructions such as the image selection, quantity to print, etc. You can print multiple images in one batch or give the print order to a photofinisher.
- **Specifying Images for a Photobook** (p.279)
You can specify images in the card for printing in a photobook.

Preparing to Print

The direct printing procedure can be performed entirely with the camera while you look at the LCD monitor.

Connecting the Camera to a Printer

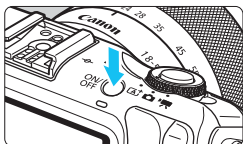

1 Set the camera's power to <OFF>.

2 Set up the printer.

- For details, see the printer's instruction manual.

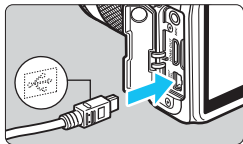

3 Connect the camera to the printer.

- Use the interface cable provided with the camera.
- Connect the cable to the camera's <DIGITAL> terminal with the cable plug's <↔> icon facing the front of the camera.
- To connect to the printer, refer to the printer's instruction manual.

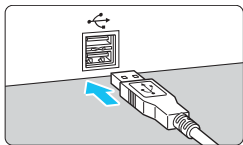

4 Turn on the printer.

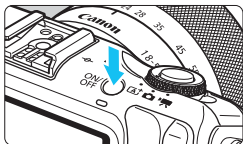



5 Set the camera's power to <ON>.
▶ Some printers may make a beeping sound.

PictBridge



6 Play back the image.

- Press the <  > button.
- ▶ The image will appear, and the <  > icon will appear on the upper left to indicate that the camera is connected to a printer.



- Movies cannot be printed.
- The camera cannot be used with printers compatible only with CP Direct or Bubble Jet Direct.
- Do not use any interface cable other than the one provided.
- If there is a long beeping sound in step 5, it indicates a problem with the printer. Resolve the problem displayed in the error message (p.274).



- You can also print RAW images taken with this camera.
- If you use a battery pack to power the camera, make sure it is fully charged. With a fully-charged battery, printing up to approx. 2 hr. 30 min. is possible.
- Before disconnecting the cable, first turn off the camera and printer. Hold the plug (not the cord) to pull out the cable.
- For direct printing, using AC Adapter Kit ACK-E12 (sold separately) to power the camera is recommended.

Printing

The screen display and setting options will differ depending on the printer. Some settings may not be available. For details, refer to the printer's instruction manual.

Printer-connected icon



1 Select the image to be printed.

- Check that the <Printer icon> is displayed on the upper left of the LCD monitor.
- Press the <Left Arrow * Right Arrow> button to select the image to be printed.

2 Press <Q/SET>.

- ▶ The print setting screen will appear.

Print setting screen

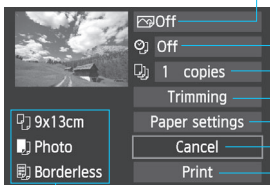

— Sets the printing effects (p.270).

— Sets the date or file number imprinting to on or off.

— Sets the quantity to be printed.

— Sets the trimming (cropping) (p.273).

— Sets the paper size, type, and layout.

— Returns to the screen in step 1.

— Starts the printing.

The paper size, type, and layout you have set are displayed.

* Depending on the printer, certain settings such as the date and file number imprinting and trimming may not be selectable.

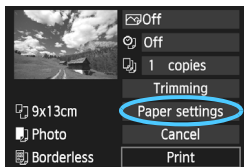

3 Select [Paper settings].

- Select [Paper settings], then press <Q/SET>.
- ▶ The paper settings screen will appear.

Setting the Paper Size

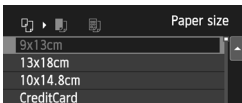

- Select the size of the paper loaded in the printer, then press **<Q/SET>**.
- ▶ The paper type screen will appear.

Setting the Paper Type

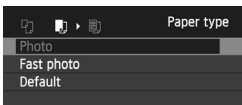

- Select the type of the paper loaded in the printer, then press **<Q/SET>**.
- ▶ The page layout screen will appear.

Setting the Page Layout

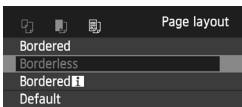

- Select the page layout, then press **<Q/SET>**.
- ▶ The print settings screen will reappear.

Bordered	The print will have white borders along the edges.
Borderless	The print will have no borders. If your printer cannot print borderless prints, the print will have borders.
Bordered I	The shooting information* ¹ will be imprinted on the border on 9x13 cm and larger prints.
xx-up	Option to print 2, 4, 8, 9, 16, or 20 images on one sheet.
20-up I 35-up I	20 or 35 images will be printed as thumbnails on A4 or Letter size paper* ² . • [20-up I] will have the shooting information* ¹ imprinted.
Default	The page layout will vary depending on the printer model or its settings.

*1: From the Exif data, the camera name, lens name, shooting mode, shutter speed, aperture, exposure compensation amount, ISO speed, white balance, etc., will be imprinted.

*2: After ordering the prints with "Digital Print Order Format (DPOF)" (p.275), it is recommended that you print by following "Direct Printing with DPOF" (p.278).



If the image's aspect ratio is different from the printing paper's aspect ratio, the image may be cropped significantly if you print it as a borderless print. If the image is cropped, it may look more grainy on the paper due to the fewer number of pixels.

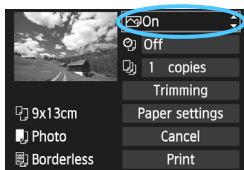

4 Set the printing effects.

- Set them if necessary. If you do not need to set any printing effects, go to step 5.
- **What is displayed on the screen differs depending on the printer.**
- Select the option, then press **<Q/SET>**.
- Select the desired printing effect, then press **<Q/SET>**.
- If the **<INFO [INFO] >** icon is displayed brightly, you can also adjust the printing effect (p.272).

Printing Effect	Description
On	The image will be printed using the printer's standard colors. The image's Exif data is used to make automatic corrections.
Off	No automatic correction will be applied.
Vivid	The image will be printed with higher saturation to produce more vivid blues and greens.
NR	Image noise is reduced before printing.
B/W B/W	Prints in black-and-white with true blacks.
B/W Cool tone	Prints in black-and-white with cool, bluish blacks.
B/W Warm tone	Prints in black-and-white with warm, yellowish blacks.
Natural	Prints the image in the actual colors and contrast. No automatic color adjustments are applied.
Natural M	The printing characteristics are the same as the "Natural" setting. However, this setting enables finer printing adjustments than with "Natural".
Default	The printing will differ depending on the printer. For details, refer to the printer's instruction manual.

* **When you change the printing effects, changes are reflected in the image displayed on the upper left. Note that the printed image may look slightly different from the displayed image, which is only an approximation. This also applies to [Brightness] and [Adjust levels] on page 272.**

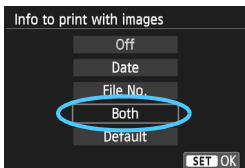

5 Set the date and file number imprinting.

- Set it if necessary.
- Select , then press **<Q/SET>**.
- Set as desired, then press **<Q/SET>**.



6 Set the number of copies.

- Set it if necessary.
- Select , then press **<Q/SET>**.
- Set the number of copies, then press **<Q/SET>**.

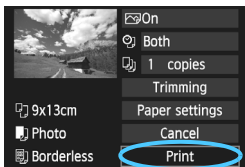

7 Start printing.

- Select **[Print]**, then press **<Q/SET>**.



- The **[Default]** setting for printing effects and other options are the printer's own default settings as set by the printer's manufacturer. Refer to the printer's instruction manual to find out what the **[Default]** settings are.
- Depending on the image's file size and image-recording quality, it may take some time for the printing to start after you select **[Print]**.
- If image tilt correction (p.273) is applied, it may take longer to print the image.
- To stop the printing, press **<Q/SET>** while **[Stop]** is displayed, then select **[OK]**.
- If you execute **[Clear all camera settings]** (p.216), all the settings will revert to their defaults.

Adjustment of Printing Effects

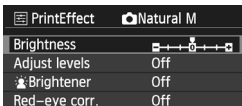
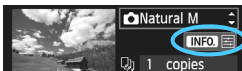

In step 4 on page 270, select the printing effect. When the < **INFO.** > icon is displayed brightly, you can press the <INFO.> button. You can then adjust the printing effect. What can be adjusted or what is displayed will depend on the selection made in step 4.

Brightness

The image brightness can be adjusted.

Adjust levels

When you select [**Manual**], you can change the histogram's distribution and adjust the image's brightness and contrast.

With the Adjust levels screen displayed, press the <INFO.> button to change the position of the <↑>. Press the <◀*>/<▶☒> button to change the shadow level (0-127) or highlight level (128-255).

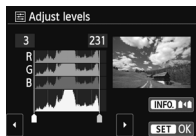

Brightener

Effective in backlit conditions that can make the subject's face look dark. When [**On**] is set, the face will be brightened for printing.

Red-eye corr.

Effective for images shot using flash, where the subject has red eye. When [**On**] is set, the red eye will be corrected for printing.

- The [**Brightener**] and [**Red-eye corr.**] effects will not be reflected on the screen.
- When you select [**Detail set.**], you can adjust the [**Contrast**], [**Saturation**], [**Color tone**], and [**Color balance**]. To adjust the [**Color balance**], change the values: B is for blue, A for amber, M for magenta, and G for green. The image's color balance will be corrected towards the selected color.
- If you select [**Clear all**], all the printing effect settings will be reverted to their defaults.

Trimming the Image

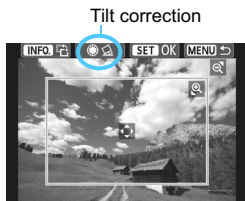

You can crop the image and print only the trimmed portion as if the image was recomposed.

Set the trimming right before printing. If you set the trimming and then set the print settings, you may have to set the trimming again before printing.

1 On the print settings screen, select [Trimming].

2 Set the trimming frame size, position, and aspect ratio.

- The image area within the trimming frame will be printed. The trimming frame's aspect ratio can be changed with [Paper settings].

Changing the trimming frame size

Tap the screen and pinch two fingers closed or spread them apart as necessary to change the size of the trimming frame. The smaller the trimming frame, the larger the image magnification will be for printing.

Moving the trimming frame

Press the <▲/🌀/📄>/<▼/🗑️>/<◀️/✳️/>/<▶️/📄> button to move the frame over the image vertically or horizontally. Move the trimming frame until it covers the desired image area.

Rotating the frame

Pressing the <INFO.> button will toggle the trimming frame between the vertical and horizontal orientations. This enables you to create a vertically oriented print from a horizontal image.

Image tilt correction

By turning the <🌀> dial, you can adjust the image tilt angle up to ±10 degrees in 0.5-degree increments. When you adjust the image tilt, the <📄> icon on the screen will turn blue.

3 Press <📄/SET> to exit the trimming.

- ▶ The print settings screen will reappear.
- You can check the trimmed image area on the upper left of the print settings screen.

- Depending on the printer, the trimmed image area may not be printed as you specified.
- The smaller you make the trimming frame, the grainier the picture will look in the print.
- While trimming the image, look at the camera's LCD monitor. If you look at the image on a TV screen, the trimming frame may not be displayed accurately.



Handling Printer Errors

If you resolve a printer error (no ink, no paper, etc.) and select **[Continue]** to resume printing but it does not resume, operate the buttons on the printer to resume printing. For details on resuming the printing, refer to the printer's instruction manual.

Error Messages

If a problem occurs during printing, an error message will appear on the camera's LCD monitor. Press **<Q/SET>** to stop printing. After fixing the problem, resume printing. For details on how to fix a printing problem, refer to the printer's instruction manual.

Paper Error

Check whether the paper is properly loaded in the printer.

Ink Error

Check the printer's ink level, and check the waste ink tank.

Hardware Error

Check for any printer problems other than paper and ink problems.

File Error

The selected image cannot be printed via PictBridge. Images taken with a different camera or images edited with a computer may not be printable.

Digital Print Order Format (DPOF)

You can set the print type, date imprinting, and file number imprinting. The print settings will be applied to all print-ordered images. (They cannot be set individually for each image.)

Setting the Printing Options

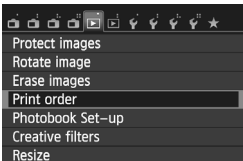

1 Select [Print order].

- Under the [▶] 1 tab, select [Print order], then press <Q/SET>.

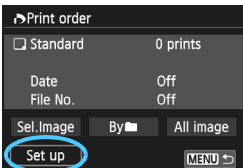

2 Select [Set up].

- Select [Set up], then press <Q/SET>.

3 Set the option as desired.

- Set the [Print type], [Date], and [File No.].
- Select the option to be set, then press <Q/SET>. Select the desired setting, then press <Q/SET>.

[Print type]

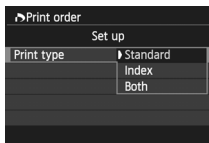

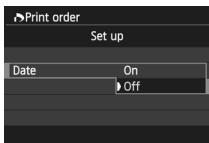

[Date]

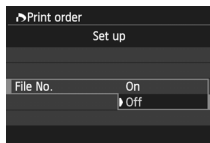

[File No.]



Print type		Standard	Prints one image on one sheet.
		Index	Multiple thumbnail images are printed on one sheet.
		Both	Prints both the standard and index prints.
Date	On	[On]	imprints the recorded date on the print.
	Off		
File number	On	[On]	imprints the file number on the print.
	Off		

4 Exit the setting.

- Press the <MENU> button.
- ▶ The print order screen will reappear.
- Next, select [**Sel. Image**], [**By** ], or [**All image**] to order the images to be printed.

- Even if [**Date**] and [**File No.**] are set to [On], the date or file number may not be imprinted depending on the print type setting and printer model.
- With [**Index**] prints, the [**Date**] and [**File No.**] cannot both be set to [On] at the same time.
- When printing with DPOF, you must use the card whose print order specifications have been set. It will not work if you just extract images from the card and try to print them.
- Certain DPOF-compatible printers and photofinishers may not be able to print the images as you specified. Refer to the printer's instruction manual before printing. Or check with your photofinisher about compatibility when ordering prints.
- Do not insert into the camera a card whose print order was set by a different camera and then try to specify a print order. The print order may be overwritten. Also, depending on the image type, the print order may not be possible.

 RAW images and movies cannot be print ordered. You can print RAW images through direct printing (p.278).

Print Ordering

Sel.Image

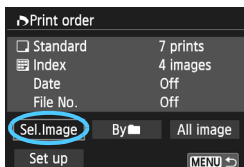

Select and order images one by one. By touching the LCD monitor with two fingers spread apart and then pinching the fingers, a three-image display will appear. You can then select images. To return to the single screen, touch the LCD monitor with two pinched fingers, then spread the fingers. Press the <MENU> button to save the print order to the card.



Quantity

Total images selected

[Standard] [Both]

Press the <▲ [Up Arrow] / [Left Arrow] / [Right Arrow] / [Down Arrow] / [Trash] > button to set the number of copies to be printed for the displayed image.



Checkmark

Index icon

[Index]

Press <[Q]/SET > to add a checkmark to the box <✓>. The image will be included in the index print.

By [Folder Icon]

Select **[Mark all in folder]** and select the folder. A print order for one copy of all the images in the folder will be placed. If you select **[Clear all in folder]** and select the folder, the print order for that folder will all be canceled.

All image

If you select **[Mark all on card]**, one copy of all the images on the card will be set for printing. If you select **[Clear all on card]**, the print order will be cleared for all the images on the card.



- Note that RAW images and movies will not be included in the print order even if you set "By [Folder Icon]" or "All image".
- When using a PictBridge printer, specify no more than 400 images for one print order. If you specify more than this, all the images may not be printed.

Direct Printing with DPOF

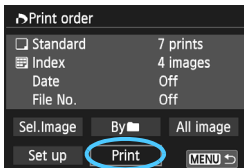

With a PictBridge printer, you can easily print images with DPOF.

1 Prepare to print.

- See page 266. Follow the “Connecting the Camera to a Printer” procedure up to step 5.

2 Under the [▶1] tab, select [Print order].

3 Select [Print].

- [Print] will be displayed only if the camera is connected to a printer and printing is possible.

4 Set the [Paper settings] (p.268).

- Set the printing effects (p.270) if necessary.

5 Select [OK].

- Before printing, be sure to set the paper size.
- Certain printers cannot imprint the file number.
- If [Bordered] is set, certain printers may imprint the date on the border.
- Depending on the printer, the date may appear faint if it is imprinted on a bright background or on the border.

- Under [Adjust levels], [Manual] cannot be selected.
- If you stopped the printing and want to resume printing the remaining images, select [Resume]. Note that printing will not resume if you stop the printing and any of the following occurs:
 - Before resuming the printing, you changed the print order or deleted print-ordered images.
 - When you set the index, you changed the paper settings before resuming the printing.
 - When you paused the printing, the card's remaining capacity was low.
- If a problem occurs during printing, see page 274.



Specifying Images for a Photobook

When you select images to use in photobooks (up to 998 images) and use EOS Utility (provided software) to transfer them to a computer, the selected images will be copied into a dedicated folder. This function is useful for ordering photobooks online and for printing photobooks on a printer.

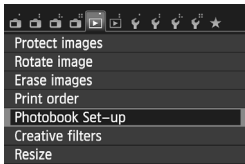
Specify One Image at a Time



1 Select [Photobook Set-up].

- Under the [ 1] tab, select [Photobook Set-up], then press </SET>.

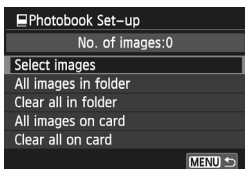





2 Select [Select images].

- Select [Select images], then press </SET>.
- ▶ The images will be displayed.
- By touching the LCD monitor with two fingers spread apart and then pinching the fingers, a three-image display will appear. You can then select images. To return to the single screen, touch the LCD monitor with two pinched fingers, then spread the fingers.



3 Select the image to be specified.

- Press the < * >/> > button to select the image to be specified, then press </SET>.
- Repeat this step. The number of images which have been specified will be displayed on the screen's upper left.
- To cancel the specified image, press </SET> again.
- Press the <MENU> button to return to the screen in step 2.

Specifying All Images in a Folder or on a Card

You can specify all the images in a folder or on a card at one time.

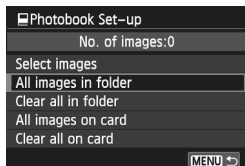

When [**▶** 1: **Photobook Set-up**] is set to [**All images in folder**] or [**All images on card**], all the images in the folder or card will be specified.

To cancel the image specification, select [**Clear all in folder**] or [**Clear all on card**].

ⓘ Do not specify for a photobook with this camera images that were already specified for a different photobook using another camera. The photobook settings may be overwritten.

- You can specify up to 998 images.
- RAW images and movies cannot be specified.



Set up the EOS M just the way you like it.

Customisable controls allow you to fine-tune the camera's behaviour according to your own preferences.

10

Customizing the Camera

You can customize various camera functions to suit your picture-taking preferences with Custom Functions. Custom Functions can be set and used only in Creative Zone modes.

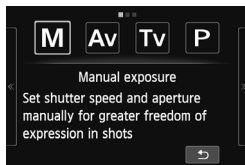

MENU Setting Custom Functions ☆

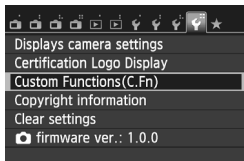

1 Select [Custom Functions (C.Fn)].

- Under the [**F4**] tab, select [**Custom Functions (C.Fn)**], then press **<Q/SET>**.

Custom Function number

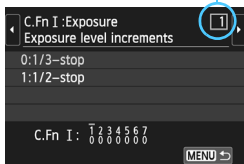

2 Select the Custom Function number.

- Press the **<◀*>/<▶☒>** button to select the Custom Function number, then press **<Q/SET>**.

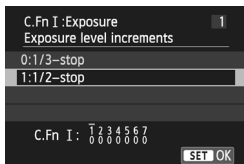

3 Change the setting as desired.

- Press the **<▲☺/☐>/<▼☒>** button to select the setting (number), then press **<Q/SET>**.
- Repeat steps 2 and 3 if you want to set another Custom Functions.
- At the bottom of the screen, the current Custom Function settings are indicated below the respective function numbers.

4 Exit the setting.

- Press the **<MENU>** button.
- ▶ The screen for step 1 will reappear.

Clearing All Custom Functions

Under [**F4: Clear settings**], select [**Clear all Custom Func. (C.Fn)**] to clear all the Custom Function settings (p.216).

Custom Functions

C.Fn I: Exposure			Still Photo Shooting	Movie Shooting
1	Exposure level increments	p.284	<input type="radio"/>	<input type="radio"/>
2	ISO expansion		<input type="radio"/>	<input type="radio"/>

C.Fn II: Image

3	Highlight tone priority	p.285	<input type="radio"/>	<input type="radio"/>
---	-------------------------	-------	-----------------------	-----------------------

C.Fn III: Autofocus

4	AF-assist beam (LED) firing	p.286	<input type="radio"/>	-
---	-----------------------------	-------	-----------------------	---

* If you use an EX-series Speedlite (sold separately) equipped with an LED light, the LED light will turn on for AF-assist even in the AF \square (), AF(), and AF \square modes.

C.Fn IV: Operation/Others

5	Shutter/AE lock button	p.286	<input type="radio"/>	<input type="radio"/>
6	\blacktriangledown \square button function	p.287	<input type="radio"/>	<input type="radio"/> *
7	Release shutter w/o lens		<input type="radio"/>	<input type="radio"/>

* If [Depth-of-field preview] or [Flash exposure comp.] is set, it will be invalid "-".

MENU Custom Function Settings ☆

Custom Functions are organized into four groups based on the function type: C.Fn I: Exposure, C.Fn II: Image, C.Fn III: Autofocus, C.Fn IV: Operation/Others.

C.Fn I: Exposure

C.Fn-1 Exposure level increments

0: 1/3-stop

1: 1/2-stop

Sets 1/2-stop increments for the shutter speed, aperture, exposure compensation, AEB, flash exposure compensation, etc. This is effective when you prefer to control the exposure in less fine increments than 1/3-stop increments.

 With setting 1, the exposure level will be displayed on the LCD monitor as shown below.



C.Fn-2 ISO expansion

0: Off

1: On

When you set the ISO speed, you will be able to set “H” (equivalent to ISO 25600) for still photos and “H” (equivalent to ISO 12800) for movies. Note that if [C.Fn-3: Highlight tone priority] is set to [1: Enable], “H” cannot be set.

C.Fn II: Image

C.Fn-3 Highlight tone priority

0: **Disable**

1: **Enable**

Improves the highlight detail. The dynamic range is expanded from the standard 18% gray to bright highlights. The gradation between the grays and highlights becomes smoother.



- With setting 1, the Auto Lighting Optimizer (p.159) is automatically set to **[Disable]** and the setting cannot be changed.
- With setting 1, noise (grainy image, banding, etc.) may become slightly more pronounced than with setting 0.



With setting 1, the range that can be set will be ISO 200 - 12800 (up to ISO 6400 for movies).

Also, the <D+> icon will be displayed on the LCD monitor when highlight tone priority is enabled.

C.Fn III: Autofocus

C.Fn-4 AF-assist beam (LED) firing

You can enable or disable the AF-assist beam.

0: Enable

When necessary, the self-timer/AF-assist beam will emit the AF-assist beam. This setting is applicable also for LED-compatible external flashes.

1: Disable

The AF-assist beam is not emitted.

C.Fn IV: Operation/Others

C.Fn-5 Shutter/AE lock button

0: AF/AE lock

1: AE lock/AF

This is convenient when you want to focus and meter separately. Press the <◀ * > button to autofocus, and press the shutter button halfway to apply AE lock.

2: AF/AF lock, no AE lock



In the Servo AF operation, you can press the <◀ * > button to stop the AF operation momentarily. This prevents the AF from being thrown off by any obstacle passing between the camera and subject. The exposure is set at the moment the picture is taken.

3: AE/AF, no AE lock

This is useful for subjects which keep moving and stopping repeatedly. With Servo AF, pressing the <◀ * > button starts or stops the Servo AF. The exposure is set at the moment the picture is taken. Thus, the optimum focusing and exposure will always be achieved as you wait for the decisive moment.

- During continuous shooting, even if you press the <◀ * > button, the AF operation will not start or stop.
- During continuous shooting without autofocus, using the [1: AE lock/AF] or [3: AE/AF, no AE lock] setting, the maximum number of frames per second depends on the AF operation settings and the lens used (p.134).

C.Fn-6 button function

You can assign a frequently-used function to the  button. While the camera is ready to shoot, press .

0: Normal (set center AF point)

1: Depth-of-field preview

The aperture opening (diaphragm) changes only at the moment when the picture is taken. Otherwise, the aperture remains fully open.



Therefore, when you look at the scene on the LCD monitor, the depth of field will look narrow.

Press the  button to stop down the lens to the current aperture setting and check the depth of field (range of acceptable focus).



Even when the aperture is stepped down, the modeling flash of an external flash will not fire.

2: ISO speed

The ISO speed setting screen will appear. Press the  button or turn the  dial to set the ISO speed.

3: Flash exposure compensation

Set flash exposure compensation if the flash exposure of the subject does not come out as desired. You can set the exposure compensation up to ± 2 stops in 1/3-stop increments.

4: Incr LCD brightness (temp)

Pressing the  button will set the LCD monitor brightness to the same level as the menu's "7" setting. Press the button again and it will return to the previous brightness.

If the power turns **<OFF>** or the brightness adjustment screen is displayed with the menu, the previous brightness will return.

C.Fn-7 Release shutter w/o lens

0: Disable

When set to **[Disable]**, not only the shutter button is disabled but the  (Movie start/stop) button will be disabled as well. Even if you press the button, movie recording will not start.

1: Enable

Even when no lens is attached to the camera, pressing the shutter button completely will release the shutter.

MENU Registering My Menu ☆

Under the My Menu tab, you can register up to six menu options and Custom Functions whose settings you change frequently.

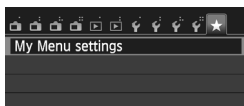

1 Select [My Menu settings].

- Under the [★] tab, select [My Menu settings], then press <Q/SET>.

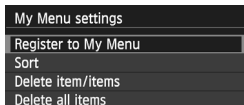

2 Select [Register to My Menu].

- Select [Register to My Menu], then press <Q/SET>.

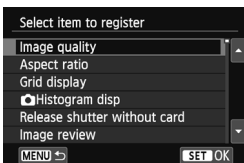

3 Register the desired items.

- Select an item to register, then press <Q/SET>.
- On the confirmation dialog, select [OK] and press <Q/SET> to register the item.
- You can register up to six items.
- To return to the screen in step 2, press the <MENU> button.

About My Menu Settings

• Sort

You can change the order of the registered items in My Menu. Select [Sort], select the item whose order you want to change, and then press <Q/SET>. With [▲]/[▼] displayed, press the <▲Ⓢ/□>/<▼🗑> button to change the order, then press <Q/SET>.

• Delete item/items and Delete all items

You can delete any of the registered items. [Delete item/items] deletes one item at a time, and [Delete all items] deletes all registered items.

• Display from My Menu

When [Enable] is set, the [★] tab will be displayed first when you display the menu screen.

11

Reference

This chapter provides reference information for camera features, system accessories, etc.



Certification Logo

Under the [**F4**] tab, if you select [**Certification Logo Display**] and press <[**Q**]/SET>, some of the logos of the camera's certifications will appear. Other certification logos can be found in this Instruction Manual, on the camera body, and on the camera's package.

Using a Household Power Outlet

With AC Adapter Kit ACK-E12 (sold separately), you can connect the camera to a household power outlet and not worry about the remaining battery level.

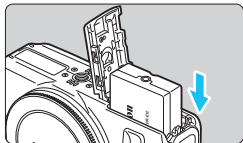

1 Insert the DC Coupler.

- Open the cover and insert the DC Coupler until it locks in place.

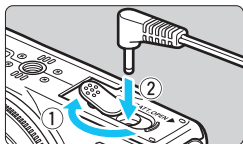

2 Connect the DC Coupler.

- 1. Open the cover, 2. Insert the adapter's plug into the coupler firmly.

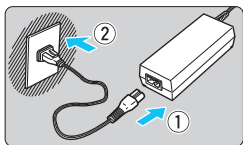

3 Connect the power cord.

- Connect the power cord as shown in the illustration.
- After using the camera, unplug the power plug from the power outlet.

 Do not connect or disconnect the power cord while the camera's power is set to <ON>.

Remote Control Shooting

Remote Controller RC-6 (Sold Separately)

This Remote Controller enables you to take pictures wirelessly up to approx. 5 meters/16.4 feet from the front of the camera. You can either shoot immediately or use a 2-sec. delay.

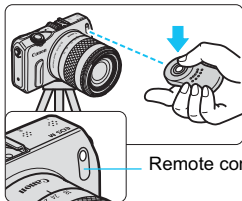

Remote control sensor

- Set the self-timer to  (p.136).
- Point the Remote Controller toward the camera's remote control sensor and press the transmit button.
- ▶ The camera will autofocus.
- ▶ When focus is achieved, the self-timer lamp will light up and the picture will be taken.

 Fluorescent or LED lighting may cause camera misoperation by triggering the shutter inadvertently. Try to keep the camera away from such light sources.

- 
- Remote Controller RC-1/RC-5 (sold separately) can also be used.
 - The Remote Controller can also be used for shooting movies (p.177). Remote Controller RC-5 cannot be used to take still photos in the movie shooting mode.

External Speedlites

EOS-dedicated, EX-series Speedlites

The basic operation is simple.

When an EX-series Speedlite (sold separately) is attached to the camera, almost all the automatic flash control is done by the camera. In other words, it is almost the same as using a built-in flash.

For detailed instructions, refer to the EX-series Speedlite's instruction manual. This camera is a Type-A camera that can use all the features of EX-series Speedlites.



Shoe-mount Speedlites

Macro Lites

Flash modes and shooting modes when using EOS-dedicated, EX-series Speedlite flashes other than the Speedlite 90EX.

Shooting Mode	Flash mode
(Scene Intelligent Auto)	Flash on
(Creative Auto)	Flash on
(Portrait)	Flash on
(Landscape)	Flash on
(Close-up)	Flash on
(Sports)	Flash on
(Night Portrait)	Flash on
(Handheld Night Scene)	Flash on
(HDR Backlight Control)	Flash off
P (Program AE)/ Tv / Av / M	Flash on
Movies	Flash off



● FE Lock

FE Lock is a flash photography method that ensures that every part of the subject is correctly illuminated. Frame the subject so it appears in the center of the screen and press the camera's <◀ * > button before taking the picture.



- FE Lock may not be correctly applied if the < **✳** > button is not held pressed for at least 1 second with the flash unit attached.
- When a flash unit is attached, the shutter will not be released if you press the shutter button completely at once. The shutter will only be released if you press and hold the shutter button for at least 1 second.



- With an EX-series Speedlite not compatible with flash function settings (p.222), only [**Flash exposure compensation**] can be set for [**External flash func. setting**]. (With certain EX-series Speedlites, [**Shutter synchronization**] can also be set.)
- If flash exposure compensation is set with the external Speedlite, the flash exposure compensation icon displayed on the camera's LCD monitor will change from  to .
- If the Speedlite's Custom Function has the flash metering mode set to TTL autoflash, the flash will fire at full output only.
- With external flashes other than the EX-series Speedlites equipped with an LED light, the AF-assist beam will not be emitted.

Canon Speedlites Other Than the EX-series

- **With an EZ/E/EG/ML/TL-series Speedlite set in TTL or A-TTL autoflash mode, the flash can be fired at full output only.**
Set the camera's shooting mode to < **M** > (manual exposure) or < **Av** > (aperture-priority AE) and adjust the aperture setting before shooting.
- When using a Speedlite that has manual flash mode, shoot in the manual flash mode.

Using Non-Canon Flash Units

Sync Speed

The camera can synchronize with compact, non-Canon flash units at 1/200 sec. or slower shutter speeds. Use a sync speed slower than 1/200 sec. Be sure to test the flash unit beforehand to make sure it synchronizes properly with the camera.



- If the camera is used with a flash unit or flash accessory dedicated to another camera brand, the camera may not operate properly and malfunction may result.
- Do not attach a high-voltage flash unit on the camera's hot shoe. It may not fire.

Using Eye-Fi Cards

With a commercially-available Eye-Fi card already set up, you can automatically transfer captured images to a personal computer or upload them to an online service via a wireless LAN.

The image transfer is a function of the Eye-Fi card. For instructions on how to set up and use the Eye-Fi card or to troubleshoot any image transfer problems, refer to the Eye-Fi card's instruction manual or contact the card's manufacturer.

⚠ The camera is not guaranteed to support Eye-Fi card functions (including wireless transfer). In case of an issue with an Eye-Fi card, please check with the card manufacturer. Also note that approval is required to use Eye-Fi cards in many countries or regions. Without approval, use of the card is not permitted. If it is unclear whether the card has been approved for use in your area, please check with the card manufacturer.

1 Insert an Eye-Fi card (p.34).

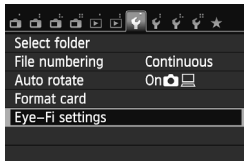

2 Select [Eye-Fi settings].

- Under the [**1**] tab, select [**Eye-Fi settings**], then press <**Q**/SET >.
- This menu is displayed only when an Eye-Fi card is inserted into the camera.

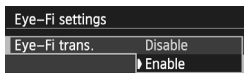

3 Enable Eye-Fi transmission.

- Press <**Q**/SET >, set [**Eye-Fi trans.**] to [**Enable**], then press <**Q**/SET >.
- If you set [**Disable**], automatic transmission will not occur even with the Eye-Fi card inserted (transmission status icon ).

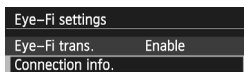

4 Display the connection information.

- Select [**Connection info.**], then press <**Q**/SET >.



5 Check the [Access point SSID:].

- Check that an access point is displayed for [Access point SSID:].
- You can also check the Eye-Fi card's MAC address and firmware version.
- Press the <MENU> button three times to exit the menu.



Transmission status icon

6 Take the picture.

- ▶ The picture is transferred and the <📶> icon switches from gray (not connected) to one of the icons below.
- For transferred images, 📷 is displayed in the shooting information display (p.256).

- 📶 (Gray) **Not connected** : No connection with access point.
- 📶 (Blinking) **Connecting** : Connection with access point.
- 📶 (Displayed) **Connected** : Connection to access point established.
- 📶 (↑) **Transferring** : Image transfer to access point in progress.

⚠ Cautions for Using Eye-Fi Cards

- If "⚠" is displayed, an error occurred while retrieving the card information. Turn the camera's power off and on again.
- Even if [Eye-Fi trans.] is set to [Disable], it may still transmit a signal. In hospitals, airports, and other places where wireless transmissions are prohibited, remove the Eye-Fi card from the camera.
- If the image transfer does not function, check the Eye-Fi card and personal computer settings. For details, refer to the card's instruction manual.
- Depending on the wireless LAN's connection conditions, the image transfer may take longer or it may be interrupted.
- Because of the transmission function, the Eye-Fi card may become hot.
- The battery power will be consumed faster.
- During the image transfer, auto power off will not take effect.

Function Availability Table According to Shooting Mode

● : Set automatically ○ : User selectable □ : Not selectable/Disabled

Shooting Mode		A+	Basic Zone							Creative Zone				M		
			CA	AF	AE	AF	AE	AF	AE	P	Tv	Av	M	M	M	
All image quality settings selectable		○	○	○	○	○	○	○	○	○	○	○	○	○	○	○
ISO speed	Automatically set/ Auto ISO	●	●	●	●	●	●	●	●	○	○	○	○	○	●	○
	Manual									○	○	○	○			○
	Maximum for Auto									○	○	○	○			
Creative filters			○	○	○	○	○	○		○	○	○	○			
Picture Style	Automatic selection	●	●	●	●	●	●	●	●							
	Manual selection									○	○	○	○	○	○	○
Ambience-based shots			○	○	○	○	○	○	○							
Light/scene-based shots				○	○	○	○									
White balance	Auto	●	●	●	●	●	●	●	●	○	○	○	○	○	○	○
	Preset									○	○	○	○	○	○	○
	Custom									○	○	○	○	○	○	○
	Correction/ Bracketing									○	○	○	○	○	○	○
Auto Lighting Optimizer		●	●	●	●	●	●	●	●	○	○	○	○	○	○	○
Lens aberration correction	Peripheral illumination correction	○	○	○	○	○	○	○	○	○	○	○	○	○	○	○
	Chromatic aberration correction	○	○	○	○	○	○	○	○	○	○	○	○			
Long exposure noise reduction										○	○	○	○			
High ISO speed noise reduction		●	●	●	●	●	●	●	●	○	○	○	○			
Highlight tone priority										○	○	○	○	○	○	○
Color space	sRGB	●	●	●	●	●	●	●	●	○	○	○	○			
	Adobe RGB									○	○	○	○			
AF operation	One-Shot AF	●	●	●	●	●		●	●	○	○	○	○	○	●	●
	Servo AF							●		○	○	○	○			
AF method	Face+Tracking	○	○	○	○	○	○	○	○	○	○	○	○	○	○	○
	FlexiZone - Multi	○	○	○	○	○	○	○	○	○	○	○	○	○	○	○
	FlexiZone - Single	○	○	○	○	○	○	○	○	○	○	○	○	○	○	○
Focus mode	AF	●*	○	○	○	○	○	○	○	○	○	○	○	○	○	○
	MF	*	○	○	○	○	○	○	○	○	○	○	○	○	○	○
	AF+MF	*	○	○	○	○	○	○	○	○	○	○	○	○	○	○

* Becomes ○ (user selectable) when an EF or EF-S lens is used.

Shooting Mode		A+	Basic Zone							Creative Zone				ⓘ		
			CA								P	Tv	Av	M	ⓘ	ⓘ
Continuous AF		○	○	○	○	○	○	○	○	○	○	○	○			
Movie Servo AF														○	○	
AF-assist beam		●	●	●	●	●	●	●	●	○	○	○	○			
Metering mode	Evaluative metering	●	●	●	●	●	●	●	●	○	○	○	○			
	Metering mode selection									○	○	○	○			
Exposure	Program shift									○						
	Exposure compensation									○	○	○	○	○		
	AEB									○	○	○	○	○		
	AE lock									○	○	○	○	○	○	
	Depth-of-field preview									○	○	○	○			
Drive	Single shooting	○	○	○	○	○	○	○	○	○	○	○	○	○	○	
	Continuous shooting	○	○	○	○	○	○	○	○	○	○	○	○	○*	○*	
	(10 sec.)	○	○	○	○	○	○	○	○	○	○	○	○	○*	○*	
	(2 sec.)	○	○	○	○	○	○	○	○	○	○	○	○	○*	○*	
	(Continuous)	○	○	○	○	○	○	○	○	○	○	○	○	○*	○*	
Speedlite 90EX	Automatic firing	●	○	●		●										
	Flash on		○						●	○	○	○	○			
	Flash off		○		●		●			●	○	○	○	○	●	●
	FE lock									○	○	○	○			
	Flash exposure compensation									○	○	○	○			
	Wireless control									○	○	○	○			
External flash	Function settings									○	○	○	○			
	Custom Function settings									○	○	○	○			
Aspect ratio										○	○	○	○			
Quick Control		○	○	○	○	○	○	○	○	○	○	○	○	○	○	
Feature guide		○	○	○	○	○	○	○	○	○	○	○	○	○	○	

* Only single shooting available while shooting movies.

System Map

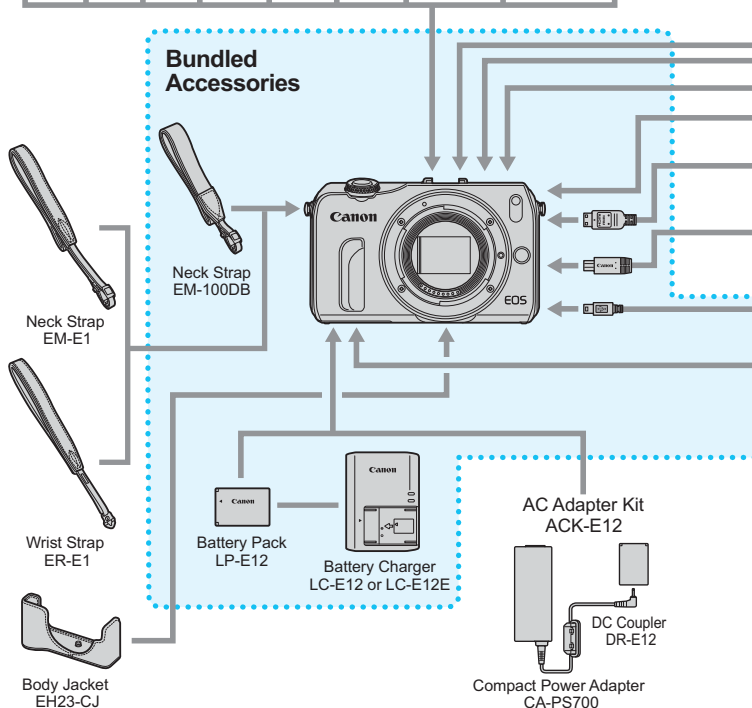

* Confirm that all the bundled accessories are included in the camera's package.

** Depending on the lens attached, use of the Off-Camera Shoe Cord OC-E3 (sold separately) may be necessary.

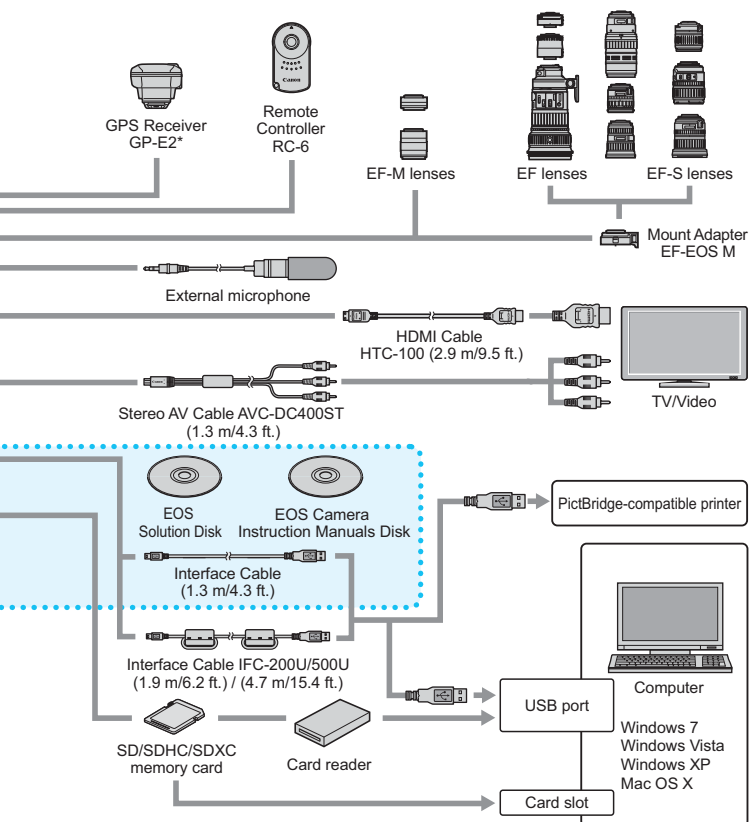

* When using a GPS device, be sure to check the countries and areas of use, and use the device in accordance with the laws and regulations of the country or region.

MENU Menu Settings

Still Photo

Shooting 1 (Red)

Page

Image quality	L / L / M / M / S1 / S1 / S2 / S3 / RAW+ L / RAW	105
Aspect ratio	3:2 / 4:3 / 16:9 / 1:1	108
Grid display	Off / Grid 1 / Grid 2	205
Histogram display	Disable / Brightness / RGB	-
Release shutter without card	Enable / Disable	204
Image review	Off / 2 sec. / 4 sec. / 8 sec. / Hold	205
External Speedlite control	Flash firing / E-TTL II metering / Flash sync. speed in Av mode / Flash function settings / Flash C.Fn settings	220



- Shaded menu options are not displayed in Scene Intelligent Auto and Basic Zone modes.
- With an EF-M lens attached, the focus mode and lens Image Stabilizer (if provided) will be displayed. Both are not displayed in Scene Intelligent Auto mode.

📷 Shooting 2 (Red)

Page









AF operation	One-Shot AF / Servo AF	130
AF method	☑️ +Tracking / FlexiZone - Multi / FlexiZone - Single	116
Continuous AF	Enable / Disable	124
Focus mode	AF / MF / AF+MF	116
Image Stabilizer	Enable / Disable	46
Lens aberration correction	Peripheral illumination: Enable / Disable Chromatic aberration: Enable / Disable	163

📷 Shooting 3 (Red)

Exposure compensation/AEB	1/3-stop or 1/2-stop increments, ±5 stops (AEB: ±2 stops)	155
ISO speed	AUTO / 100 / 200 / 400 / 800 / 1600 / 3200 / 6400 / 12800 / H	110
ISO Auto	Max.: 400 / Max.: 800 / Max.: 1600 / Max.: 3200 / Max.: 6400	113
Auto Lighting Optimizer	Disable / Low / Standard / High	159
	Disable during manual exposure	
Metering mode	☑️ Evaluative metering / ☑️ Partial metering / ☐ Spot metering / ☐ Center-weighted average metering	151
Metering timer	4 sec. / 16 sec. / 30 sec. / 1 min. / 10 min. / 30 min.	108
Touch Shutter	Enable / Disable	125

 Shooting 4 (Red)

Page

Custom White Balance	Manual setting of white balance	172
White balance shift/bracketing	WB correction: White balance correction	174
	BKT setting: White balance bracketing	175
Color space	sRGB / Adobe RGB	176
Picture Style	 Auto /  Standard /  Portrait /	114
	 Landscape /  Neutral /  Faithful /	166
	 Monochrome /  User Def. 1-3	170
High ISO speed noise reduction	Disable / Low / Standard / High / Multi Shot Noise Reduction	160
Long exposure noise reduction	Disable / Auto / Enable	161
Dust Delete Data	Obtain data to be used to erase dust spots	227

▶ Playback 1 (Blue)

Page



Protect images	Select images / All images in folder / Unprotect all images in folder / All images on card / Unprotect all images on card	252
Rotate image	Rotate vertical images	233
Erase images	Select and erase images / All images in folder / All images on card	254
Print order	Specify images to be printed (DPOF)	275
Photobook Set-up	Select images / All images in folder / Clear all in folder / All images on card / Clear all on card	279
Creative filters	Grainy B/W / Soft focus / Fish-eye effect / Art bold effect / Water painting effect / Toy camera effect / Miniature effect	260
Resize	Downsize the image's pixel count	262

▶ Playback 2 (Blue)

▶ Histogram display	Brightness / RGB	258
Image jump with 	1 image / 10 images / 100 images / Date / Folder / Movies / Stills / Rating	232
Slide show	Images (content) to play back / Display time / Repeat / Transition effect / Background music	243
Rating	[OFF] / [•] / [••] / [•••] / [••••] / [•••••]	234
Control over HDMI	Disable / Enable	249

🔧 Set-up 1 (Yellow)

Page

Select folder	Create and select a folder	208
File numbering	Continuous / Auto reset / Manual reset	210
Auto rotate	On   / On  / Off	214
Format card	Initialize and erase data on the card	57
Eye-Fi settings	Displayed when a commercially-available Eye-Fi card is used.	294

🔧 Set-up 2 (Yellow)

Power saving	LCD auto off: 15 sec. / 30 sec. / 1 min. / 3 min. / 5 min. / 10 min. / 30 min.	206
	Camera auto off: 0 sec. / 30 sec. / 1 min. / 3 min. / 5 min. / 10 min. / Disable	206
LCD brightness	Seven brightness levels provided	207
Time zone	Daylight saving time* / Time zone	40
Date/Time	Date (year, month, day) / Time (hour, min., sec.) / Daylight saving time*	41
Language 	Select the interface language	43
Video system	NTSC / PAL	251

* The daylight saving time setting is linked to **[Time zone]** and **[Date/time]**.

Set-up 3 (Yellow)

Page

Beep	Enable / Touch to  / Disable	204
Screen color	Select the shooting settings screen color	219
Feature guide	Enable / Disable	60
Touch control	Standard / Sensitive	63
Sensor cleaning	Auto cleaning: Enable / Disable	225
	Clean now	
GPS device settings	Set when GPS device attached	-

Set-up 4 (Yellow)

Displays camera settings	Display major camera settings	215
Certification Logo Display	Display some of the logos of the camera's certifications	289
Custom Functions (C.Fn)	Customize camera functions as desired	282
Copyright information	Display copyright information / Enter author's name / Enter copyright details / Delete copyright information	212
Clear settings	Clear all camera settings / Clear all Custom Func. (C.Fn)	216
 firmware ver.*	For updating the firmware	-

* During firmware updates, the touch screen will be disabled to prevent accidental operations.

My Menu (Green)

My Menu settings	Register frequently-used menu options and Custom Functions	288
-------------------------	--	-----

Movies

📷 Shooting 1 (Red)

Page

Image quality	L / L / M / M / S1 / S1 / S2 / S3 / RAW+ L / RAW	105
Grid display	Off / Grid 1 / Grid 2	205
📷 Histogram display	Disable / Brightness / RGB	181
Release shutter without card	Enable / Disable	204
Image review	Off / 2 sec. / 4 sec. / 8 sec. / Hold	205

📷 Shooting 2 (Red)









AF method	+Tracking / FlexiZone - Multi / FlexiZone - Single	116
Focus mode	AF / MF / AF+MF	116
Image Stabilizer	Enable / Disable	46
Lens aberration correction	Peripheral illumination: Enable / Disable	163

📷 Shooting 3 (Red)

Page

Exposure compensation	1/3-stop or 1/2-stop increments, ±5 stops	155
ISO speed	AUTO / 100 / 200 / 400 / 800 / 1600 / 3200 / 6400 / H	110
Auto Lighting Optimizer	Disable / Low / Standard / High	159
	Disable during manual exposure	
Metering timer	4 sec. / 16 sec. / 30 sec. / 1 min. / 10 min. / 30 min.	108

📷 Shooting 4 (Red)

Custom White Balance	Manual setting of white balance	172
White balance shift/bracketing	WB correction: White balance correction	174
	BKT setting: White balance bracketing	175
Picture Style	 Auto /  Standard /  Portrait /	114
	 Landscape /  Neutral /  Faithful /	166
	 Monochrome /  User Def. 1-3	170

Movie 1 (Red)

Page

Movie recording size	1920x1080 (130 / 125 / 124) / 1280x720 (160 / 150) / 640x480 (130 / 125)	187
Sound recording	Sound recording: Auto / Manual / Disable	197
	Recording level	
	Wind filter/Attenuator: Disable / Enable	
Video snapshot	Video snapshot: Enable / Disable	189
	Album settings: Create a new album / Add to existing album	
	Snapshot length: 2 sec. movie / 4 sec. movie / 8 sec. movie	
Movie Servo AF	Enable / Disable	199
AF with shutter button during 	ONE SHOT / Disable	200

Playback 1 (Blue)



Protect images	Select images / All images in folder / Unprotect all images in folder / All images on card / Unprotect all images on card	252
Rotate image	Rotate vertical images	233
Erase images	Select and erase images / All images in folder / All images on card	254
Print order	Specify images to be printed (DPOF)	275
Photobook Set-up	Select images / All images in folder / Clear all in folder / All images on card / Clear all on card	279
Creative filters	Grainy B/W / Soft focus / Fish-eye effect / Art bold effect / Water painting effect / Toy camera effect / Miniature effect	260
Resize	Downsize the image's pixel count	262

▶ Playback 2 (Blue)

Page

▶ Histogram display	Brightness / RGB	258
Image jump with 	1 image / 10 images / 100 images / Date / Folder / Movies / Stills / Rating	232
Slide show	Images (content) to play back / Display time / Repeat / Transition effect / Background music	243
Rating	[OFF] / [.] / [.] / [.] / [.] / [.]	234
Control over HDMI	Disable / Enable	249

⚙ Set-up 1 (Yellow)

Select folder	Create and select a folder	208
File numbering	Continuous / Auto reset / Manual reset	210
Auto rotate	On   / On  / Off	214
Format card	Initialize and erase data on the card	57
Eye-Fi settings	Displayed when a commercially-available Eye-Fi card is used.	294

⚙ Set-up 2 (Yellow)

Power saving	LCD auto off: 15 sec. / 30 sec. / 1 min. / 3 min. / 5 min. / 10 min. / 30 min.	206
	Camera auto off: 0 sec. / 30 sec. / 1 min. / 3 min. / 5 min. / 10 min. / Disable	206
LCD brightness	Seven brightness levels provided	207
Time zone	Daylight saving time* / Time zone	40
Date/Time	Date (year, month, day) / Time (hour, min., sec.) / Daylight saving time*	41
Language 	Select the interface language	43
Video system	NTSC / PAL	251

* The daylight saving time setting is linked to [Time zone] and [Date/time].

🔊 Set-up 3 (Yellow)

Page

Beep	Enable / Touch to 🔊 / Disable	204
Screen color	Select the shooting settings screen color	219
Feature guide	Enable / Disable	60
Touch control	Standard / Sensitive	63
Sensor cleaning	Auto cleaning: Enable / Disable	225
	Clean now	
GPS device settings	Set when GPS device attached	-

🔊 Set-up 4 (Yellow)

Displays camera settings	Display major camera settings	215
Custom Functions (C.Fn)	Customize camera functions as desired	282
Clear settings	Clear all camera settings / Clear all Custom Func. (C.Fn)	216

Troubleshooting Guide

If a problem occurs with the camera, first refer to this Troubleshooting Guide. If this Troubleshooting Guide does not resolve the problem, contact your dealer or nearest Canon Service Center.

Power-Related Problems

The battery pack does not recharge.

- Check that the battery pack is properly attached to the battery charger.
- Check that the battery charger is properly connected to the power outlet.
- Do not recharge any battery pack other than a genuine Canon Battery Pack LP-E12.

The battery charger's lamp blinks.

- If there is a problem with the battery charger, the protective circuit will stop the charging operation and the charge lamp will blink in orange. If this happens, disconnect the charger's power plug from the power outlet and remove the battery pack. Attach the battery pack to the charger again and wait a while before connecting the charger to a power outlet again.

The camera does not operate even when pressing the power button.

- Make sure the battery is properly installed in the camera (p.34).
- Make sure the card/battery compartment cover is closed (p.34).
- Recharge the battery (p.32).

The power/access lamp still blinks even when the power is set to <OFF>.

- If the power is turned off while an image is being recorded to the card, the power/access lamp will remain on/continue to blink for a few seconds. When the image recording is completed, the power will turn off automatically.

The battery becomes exhausted quickly.

- Use a fully-charged battery pack (p.32).
- The rechargeable battery pack performance will degrade over repeated use. Purchase a new one.
- The number of possible shots will decrease with any of the following operations:
 - Pressing the shutter button halfway for a prolonged period. (Often activating only the AF without taking a picture.)
 - Using the lens' Image Stabilizer.
 - You shoot movies for prolonged periods.
- At low temperatures, the number of possible shots decreases (p.39).

The LCD monitor turns off by itself.

- The power-saving function is turning off the LCD monitor. Press any camera button or tap the LCD monitor to turn it on again. You can change the time until the monitor turns off automatically with the [**42: Power saving**]'s [**LCD auto off**] setting.

The camera turns off by itself.

- The power-saving function is turning off the camera. If you do not want auto power off to take effect, set [**42: Power saving**]'s [**Camera auto off**] to [**Disable**] (p.206).

There is a noise when the power is turned ON/OFF (with an EF-M lens attached).

- When you turn off the camera, the lens aperture stops down to prevent light from entering the camera. This is to protect the camera's internal components. When you set the power to <ON> or <OFF>, the aperture makes a small noise as it opens or closes.

Shooting-Related Problems

No images can be shot or recorded.

- Make sure the card is properly inserted (p.34).
- Slide the card's write-protect switch to the Write/Erase position (p.34).
- If the card is full, replace the card or delete unnecessary images to make room (p.34, 254).

The card cannot be used.

- If a card error message is displayed, see page 36 or 323.

The image is out of focus.

- Set the focus mode to <AF> (p.116).
- To prevent camera shake, press the shutter button gently (p.48, 49).
- If the lens has an Image Stabilizer, set the IS to <ON> (p.46).
- In low light, the shutter speed may become slow. Use a faster shutter speed (p.142), set a higher ISO speed (p.109), use flash (p.138), or use a tripod.

I cannot lock the focus and recompose the shot.

- Set the AF operation to One-Shot AF. Focus lock is not possible in the Servo AF operation (p.131).

When Servo AF is set, it takes longer for the shutter to be released.

- Keep tracking the subject with the shutter button pressed completely.

When [FlexiZone - Multi] is set, it takes longer for the camera to focus automatically.

- Depending on the shooting conditions, it may take longer to focus the subject. Use [FlexiZone - Single] or focus manually.



The continuous shooting speed is slow.

- Depending on the lens type, shutter speed, aperture, subject conditions, brightness, etc., the continuous shooting speed may become slower.

During continuous shooting, the image on the LCD monitor seems to be out of focus.

- The displayed image may differ from the actually recorded images. Check the recorded images.

When I press the shutter button, it does not take a picture immediately.

- After you press the shutter button, if the picture is taken 10 sec. later or after you hear a beeping sound, it means the self-timer has been set. Press the <▲  /  > button and tap [□] or [] to cancel the self-timer (p.136).

The maximum burst during continuous shooting is lower.

- With (Handheld Night Scene) or (HDR Backlight Control) shooting mode, the maximum burst for continuous shooting will greatly decrease (p.87).
- With ISO 12800 or "H" (equivalent to ISO 25600), the maximum burst for continuous shooting will greatly decrease (p.111).
- With **[Chromatic aberration: Enable]**, the maximum burst for continuous shooting will greatly decrease (p.164).
- During WB bracketing, the maximum burst for continuous shooting will decrease (p.175).
- Set **[img alt="Camera icon" data-bbox="215 375 235 395"/>4: High ISO speed NR]** to **[Standard]**, **[Low]** or **[Disable]**. If it is set to **[High]** or if **[Multi Shot Noise Reduction]** is set, the maximum burst during continuous shooting will greatly decrease (p.160).
- If you shoot something that has fine detail (such as a field of grass), the file size will be larger and the actual maximum burst may be lower than the number mentioned on page 105.

ISO 100 cannot be set.

- Under **[img alt="Custom Functions icon" data-bbox="215 580 235 600"/>4: Custom Functions (C.Fn)]**, if **[3: Highlight tone priority]** is set to **[1: Enable]**, ISO 100 cannot be set. If **[0: Disable]** is set, ISO 100 can be set (p.285). This also applies to movie shooting (p.181).

ISO speed [H] (ISO 25600) cannot be set.

- Under **[img alt="Custom Functions icon" data-bbox="215 710 235 730"/>4: Custom Functions (C.Fn)]**, if **[3: Highlight tone priority]** is set to **[1: Enable]**, the [H] ISO speed (equivalent to ISO 25600) cannot be selected even when **[2: ISO expansion]** is set to **[1: On]**. If **[0: OFF]** is set, ISO [H] can be set (p.284).

The Auto Lighting Optimizer cannot be set.

- Under **[img alt="Custom Functions icon" data-bbox="215 865 235 885"/>4: Custom Functions (C.Fn)]**, if **[3: Highlight tone priority]** is set to **[1: Enable]**, the Auto Lighting Optimizer cannot be set. If **[0: Disable]** is set, the Auto Lighting Optimizer can be set (p.285).

Even though I set a decreased exposure compensation, the image comes out bright.

- Set [ **3: Auto Lighting Optimizer**] to [**Disable**]. When [**Standard**], [**Low**] or [**High**] is set, even if you set a decreased exposure compensation or flash exposure compensation, the image may come out bright (p.159).

When I use the <Av> mode with flash, the shutter speed becomes slow.

- If you shoot at night when the background is dark, the shutter speed becomes slow automatically (slow-sync shooting) so that both the subject and background are properly exposed. To prevent a slow shutter speed, under [ **1: External Speedlite control**], set [**Flash sync. speed in Av mode**] to [**1/200-1/60 sec. auto**] or [**1/200 sec. (fixed)**] (p.221).

The flash always fires at full output.

- If you use a flash unit other than an EX-series Speedlite, the flash will always be fired at full output (p.293).
- Under [ **1: External Speedlite control**], if [**Flash metering mode**] under [**Flash C.Fn settings**] is set to [**TTL**], the flash will always fire at full output (p.224).

I cannot set flash exposure compensation with [Flash function settings].

- If flash exposure compensation has been set on an external Speedlite, [**Flash exposure compensation**] (p.223) cannot be set in the [**Flash function settings**] screen. Also, if you set flash exposure compensation with the camera and then set flash exposure compensation with the external Speedlite, the Speedlite's flash exposure compensation setting will be given priority. When the Speedlite's flash exposure compensation is canceled (set to 0), [**Flash exposure compensation**] can be set with the camera.

High-speed sync cannot be set in the <Av> mode.

- Under [ 1: External Speedlite control], set [Flash sync. speed in Av mode] to [Auto] (p.221).

During shooting, the white <🔥> icon or red <🔥> icon is displayed.

- This icon indicates that the camera's internal temperature is too high. The white <🔥> icon indicates degraded still photo quality. The red <🔥> icon indicates that the power will soon turn off automatically (p.128, 201).

Movie shooting stops by itself.

- If the card's writing speed is slow, movie shooting may stop automatically. Use an SD Speed Class 6 "CLASS 6" or faster card. To find out the card's read/write speed, see the card manufacturer's Web site, etc.
- If the movie shooting time reaches 29 min. 59 sec., the movie shooting will stop automatically.

The ISO speed cannot be set for movie shooting.

- If movie autoexposure is set, the ISO speed is set automatically. You can set the ISO speed only if movie manual exposure is set (p.181).

The exposure changes during movie shooting.

- If you change the shutter speed or aperture during movie shooting, the changes in the exposure may be recorded.
- Zooming the lens during movie shooting can cause changes in the exposure regardless of whether the lens' maximum aperture changes or not. Changes in the exposure may be recorded as a result (except with the EF-S 18-135mm f/3.5-5.6 IS STM or EF-M 18-55mm f/3.5-5.6 IS STM).

The subject looks distorted during movie shooting.

- If you move the camera to the left or right quickly (high-speed panning) or shoot a moving subject, the image may look distorted.

The image flickers or horizontal stripes appear during movie shooting.

- Flickering, horizontal stripes (noise), or irregular exposures can be caused by fluorescent light, LED bulbs, or other light sources during movie shooting. Also, changes in the exposure (brightness) or color tone may also be recorded. With movie manual exposure, a slower shutter speed may alleviate these phenomena.

Operation Problems

During touch screen operations, the beeper suddenly sounds softer.

- Check if your finger is covering the speaker (p.22).

Display Problems

The menu screen shows few tabs and options.

- With Scene Intelligent Auto, Basic Zone modes, and the movie shooting mode, certain tabs and menu options are not displayed. Set the shooting mode to a Creative Zone mode (p.54).

The file name's first character is an underscore (“_”).

- Set the color space to sRGB. If Adobe RGB is set, the first character will be an underscore (p.176).

The file name starts with “MVI_”.

- It is a movie file (p.211).

The file numbering does not start from 0001.

- If the card already contains recorded images, the image number may not start from 0001 (p.210).

The shooting date and time displayed is incorrect.

- Make sure the correct date and time has been set (p.41).
- Check the time zone and daylight savings time (p.40, 42).

The date and time is not in the picture.

- The shooting date and time does not appear in the picture. The date and time is instead recorded in the image data as shooting information. When printing, you can imprint the date and time in the picture by using the date and time recorded in the shooting information (p.271).

[###] is displayed.

- If the number of images in the card exceeds the maximum number of images that the camera can display, [###] will be displayed (p.235).

The LCD monitor does not display a clear image.

- If the LCD monitor is dirty, use a soft cloth to clean it.
- In low or high temperatures, the LCD monitor display may seem slow or may look black. It will return to normal at room temperature.

[Eye-Fi settings] does not appear.

- **[Eye-Fi settings]** will appear only when an Eye-Fi card is inserted in the camera. If the Eye-Fi card has a write-protect switch set to the LOCK position, you will not be able to check the card's connection status or disable Eye-Fi card transmission (p.294).

Playback Problems

Part of the image blinks in black.

- It is the highlight alert (p.258). Overexposed highlight areas with a loss of highlight detail will blink.

The image cannot be erased.

- If the image is protected, it cannot be erased (p.252).

The movie cannot be played back.

- Movies edited with a personal computer using the provided ImageBrowser EX (p.340) or other software cannot be played back with the camera. However, video snapshot album edited with EOS Video Snapshot Task (p.196) can be played back on the camera.

When the movie is played back, camera operation noise can be heard.

- If you operate the camera's dials or lens during movie shooting, the operation noise will also be recorded. Using an external microphone (commercially available) is recommended (p.197).

The movie has still moments.

- During autoexposure movie shooting, if there is a drastic change in the exposure level, the recording will stop momentarily until the brightness stabilizes. If this happens, shoot in the <M> (manual exposure) mode (p.180).

No image appears on the TV screen.

- Use a stereo AV cable or HDMI cable (sold separately, p.247, 251).
- Make sure the stereo AV cable or HDMI cable's plug is inserted all the way in (p.247, 251).
- Set the video OUT system (NTSC/PAL) to the same video system as the TV set (p.251).

There are multiple movie files for a single movie shoot.

- If the movie file size reaches 4 GB, another movie file will be created automatically (p.188).

My card reader does not recognize the card.

- Depending on the card reader and computer OS used, SDXC cards might not be correctly recognized. If this occurs, connect your camera to the computer with the provided interface cable, then transfer the images to your computer using EOS Utility (provided software, p.340).

I cannot resize the image.

- JPEG S3 and RAW images cannot be resized (p.262).

Sensor Cleaning Problems

The shutter makes a noise during sensor cleaning.

- If you selected [**Clean now** ], the shutter will make a noise, but no picture is taken (p.225).

Automatic sensor cleaning does not work.

- If you repeatedly switch the power to <ON>/<OFF> at a short interval, the < > icon may not appear (p.37).

Printing-Related Problems

There are fewer printing effects than listed in the instruction manual.

- What is displayed on the screen differs depending on the printer. This instruction manual lists all the printing effects available (p.270).

Error Codes

Error number

If there is a problem with the camera, an error message will appear. Follow the on-screen instructions.

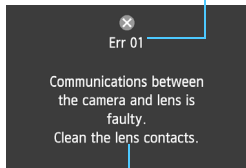

Countermeasures

Number	Error Message and Solution
01	Communications between the camera and lens is faulty. Clean the lens contacts.
	→ Clean the electrical contacts on the camera and lens or use a Canon lens (p.19, 22).
02	Card cannot be accessed. Reinsert/change card or format card with camera.
	→ Remove and insert the card again, replace the card, or format the card (p.34, 57).
04	Cannot save images because card is full. Replace card.
	→ Replace the card, erase unnecessary images, or format the card (p.34, 254, 57).
06	Sensor cleaning could not be performed. Turn the camera off and on again.
	→ Operate the power button (p.37).
10, 20, 30, 40, 50, 70, 80, 99	An error prevented shooting. Turn the camera off and on again or re-install the battery.
	→ Operate the power button, remove and install the battery pack again, or use a Canon lens (p.37, 34).
60	An error prevented shooting. Turn the camera off and on again or re-install the battery.
	→ The lens movement may be obstructed. Turn the camera off and on again, taking care not to touch the lens.

* If the error still persists, write down the error number and contact your nearest Canon Service Center.

Specifications

• Type

Type:	Digital single-lens non-reflex AF/AE camera
Recording media:	SD memory card, SDHC memory card, SDXC memory card * Compatible with UHS-I
Image sensor size:	Approx. 22.3 x 14.9 mm
Compatible lenses:	Canon EF-M, EF*, and EF-S* lenses * Mount Adapter EF-EOS M required. (35 mm-equivalent focal length is approx. 1.6 times the lens focal length)
Lens mount:	Canon EF-M mount

• Image Sensor

Type:	CMOS sensor
Effective pixels:	Approx. 18.00 megapixels
Aspect ratio:	3:2
Dust delete feature:	Auto, Dust Delete Data appending

• Recording System

Recording format:	Design rule for Camera File System (DCF) 2.0
Image type:	JPEG, RAW (14-bit Canon original) RAW+JPEG Large simultaneous recording possible
Recorded pixels:	L (Large) : Approx. 17.90 megapixels (5184 x 3456) M (Medium) : Approx. 8.00 megapixels (3456 x 2304) S1 (Small 1) : Approx. 4.50 megapixels (2592 x 1728) S2 (Small 2) : Approx. 2.50 megapixels (1920 x 1280) S3 (Small 3) : Approx. 350,000 pixels (720 x 480) RAW : Approx. 17.90 megapixels (5184 x 3456)

• Image Processing During Shooting

Picture Style:	Auto, Standard, Portrait, Landscape, Neutral, Faithful, Monochrome, User Def. 1 - 3
Basic+:	Ambience-based shots, Light/scene-based shots, Creative filters (Grainy B/W, Soft focus, Fish-eye effect, Art bold effect, Water painting effect, Toy camera effect, Miniature effect)
White balance:	Auto, Preset (Daylight, Shade, Cloudy, Tungsten light, White fluorescent light, Flash), Custom White balance correction and white balance bracketing features provided * Flash color temperature information transmission enabled

Noise reduction:	Applicable to long exposures and high ISO speed shots
Automatic image brightness correction:	Auto Lighting Optimizer
Highlight tone priority:	Provided
Lens optical correction:	Peripheral illumination correction, Chromatic aberration correction

• Autofocus

Type:	Hybrid CMOS AF System
AF points:	31 points (Max.)
Focusing brightness range:	EV 1 - 18 (at 23°C/73°F, ISO 100)
Focus mode:	AF, Manual (MF), AF+MF
AF-assist beam:	Built-in (LED lamp)

• Exposure Control

Metering modes:	Real-time metering with image sensor Evaluative metering (315 zones), Partial metering (approx. 11% of Live View screen), Spot metering (approx. 2.8% of Live View screen), Center-weighted average metering
Metering range:	EV 1 - 20 (at 23°C/73°F, ISO 100)
Exposure control:	Program AE (Scene Intelligent Auto, Creative Auto, Portrait, Landscape, Close-up, Sports, Night Portrait, Handheld Night Scene, HDR Backlight Control, Program), Shutter-priority AE, Aperture-priority AE, Manual exposure
ISO speed: (Recommended exposure index)	Basic Zone modes*: ISO 100 - 6400 set automatically * Handheld Night Scene: ISO 100 - 12800 set automatically Creative Zone modes: ISO 100 - 12800 set manually (whole-stop increments), ISO 100 - 6400 set automatically, maximum ISO speed settable for ISO Auto, or ISO expansion to "H" (equivalent to ISO 25600)
Exposure compensation:	Manual: ± 3 stops in 1/3- or 1/2-stop increments AEB: ± 2 stops in 1/3- or 1/2-stop increments (Can be combined with manual exposure compensation)
AE lock:	Auto: Applied in One-Shot AF with evaluative metering when focus is achieved Manual: With AE lock button

• Shutter

Type:	Electronically-controlled, focal-plane shutter
Shutter speeds:	1/4000 sec. to 1/60 sec. (Scene Intelligent Auto mode), X-sync at 1/200 sec. 1/4000 sec. to 30 sec., Bulb (Total shutter speed range. Available range varies by shooting mode.)

• External Speedlite

Compatible Speedlites:	EX-series Speedlite (Flash functions settable with the camera)
Flash metering:	E-TTL II autoflash
Flash exposure compensation:	±2 stops in 1/3- or 1/2-stop increments
FE lock:	Provided
PC terminal:	None

• Drive System

Drive mode:	Single shooting, continuous shooting, self-timer with 10-sec. or 2-sec. delay and 10-sec. delay with continuous shooting
Continuous shooting speed:	Max. approx. 4.3 shots/sec.
Max. burst:	JPEG Large/Fine: Approx. 15 (approx. 17) shots RAW: Approx. 6 (approx. 6) shots RAW+JPEG Large/Fine: Approx. 3 (approx. 3) shots * Figures are based on Canon's testing standards (ISO 100 and "Standard" Picture Style) using an 8 GB card. * Figures in parentheses apply to an UHS-I compatible 8 GB card based on Canon's testing standards.

• Still Photo Shooting

Aspect ratio settings:	3:2, 4:3, 16:9, 1:1
Continuous AF:	Provided
Touch shutter:	Provided
Grid display:	Two types
Depth-of-field preview:	Provided

• Movie Shooting

Movie compression:	MPEG-4 AVC/H.264 Variable (average) bit rate
Audio recording format:	Linear PCM
Recording format:	MOV
Recording size and frame rate:	1920x1080 (Full HD): 30p/25p/24p 1280x720 (HD) : 60p/50p 640x480 (SD) : 30p/25p * 30p: 29.97 fps, 25p: 25.00 fps, 24p: 23.976 fps, 60p: 59.94 fps, 50p: 50.00 fps
File size:	1920x1080 (30p/25p/24p): Approx. 330 MB/min. 1280x720 (60p/50p) : Approx. 330 MB/min. 640x480 (30p/25p) : Approx. 82.5 MB/min.
Focusing:	Hybrid CMOS AF System* (Face+Tracking, FlexiZone-Multi, FlexiZone-Single) Manual focusing (approx. 5x / 10x magnification possible) * Focusing brightness range: EV 1 - 18 (at 23°C/73°F, ISO 100)
Metering modes:	Center-weighted average and evaluative metering with the image sensor * Automatically set by the focusing mode
Metering range:	EV 1 - 20 (at 23°C/73°F, ISO 100)
Exposure control:	Program AE for movies and manual exposure
Exposure compensation:	±3 stops in 1/3-stop increments
ISO speed: (Recommended exposure index)	With autoexposure shooting: ISO 100 - 6400 set automatically With manual exposure: ISO 100 - 6400 set automatically/ manually, expandable to "H" (equivalent to ISO 12800)
Video snapshots:	Settable to 2 sec./4 sec./8 sec.
Sound recording:	Built-in stereo microphone External stereo microphone terminal provided Sound recording level adjustable, wind filter provided, attenuator provided
Grid display:	Two types

• LCD Monitor

Type:	TFT color liquid-crystal monitor
Monitor size and dots:	Wide, 7.7 cm (3.0-in.) (3:2) with approx. 1.04 million dots
Brightness adjustment:	Manual (7 levels)
Interface languages:	25
Feature guide:	Displayable

• Playback

Image display formats:	Single-image display, Single-image + Info display (Basic info, shooting info, histogram), 4-image index, 9-image index, image rotate possible
Zoom magnification:	Approx. 1.5x - 10x
Highlight alert:	Overexposed highlights blink
Image browsing methods:	Single image, jump by 10 or 100 images, by shooting date, by folder, by movies, by stills, by rating
Image rotate:	Possible
Ratings:	Provided
Movie playback:	Enabled (LCD monitor, video/audio OUT, HDMI OUT) Built-in speaker
Image protect:	Possible
Slide show:	All images, by date, by folder, movies, stills, or by rating Five transition effects selectable
Background music:	Selectable for slide shows and movie playback

• Post-Processing of Images

Creative filters:	Provided (Applied during shooting)
Resize:	Possible

• Direct Printing

Compatible printers:	PictBridge-compatible printers
Printable images:	JPEG and RAW images
Print ordering:	DPOF Version 1.1 compatible

• Custom Functions

Custom Functions:	7
My Menu registration:	Possible
Copyright information:	Entry and inclusion possible

• Interface

Audio/video OUT/

Digital terminal: Analog video (compatible with NTSC/PAL)/stereo audio output
Personal computer communication and direct printing
(Hi-Speed USB equivalent), GPS receiver GP-E2
connection

HDMI mini OUT terminal: Type C (auto switching of resolution), CEC-compatible

External microphone

IN terminal: 3.5 mm diameter stereo mini-jack

Wireless remote control: Remote Controller RC-6

Eye-Fi card: Compatible

• Power

Battery: Battery Pack LP-E12 (Quantity 1)
* AC power can be supplied via AC Adapter Kit ACK-E12

Battery life: Approx. 230 shots at 23°C/73°F

(Based on CIPA testing standards) Approx. 200 shots at 0°C/32°F

Movie shooting time: Approx. 1 hr. 30 min. at 23°C/73°F

Approx. 1 hr. 20 min. at 0°C/32°F

(with a fully-charged Battery Pack LP-E12)

• Dimensions and Weight

Dimensions (W x H x D): Approx. 108.6 x 66.5 x 32.3 mm / 4.3 x 2.6 x 1.3 in.

Weight: Approx. 298 g / 10.5 oz. (CIPA Guidelines: including
body, battery pack, card),
Approx. 262 g / 9.2 oz. (Body only, without lens cap)

• Operation Environment

Working temperature range: 0°C - 40°C / 32°F - 104°F

Working humidity: 85% or less

• Battery Pack LP-E12

Type: Rechargeable lithium-ion battery

Rated voltage: 7.2 V DC

Battery capacity: 875 mAh

Working temperature range: During charging: 5°C - 40°C / 41°F - 104°F

During shooting: 0°C - 40°C / 32°F - 104°F

Working humidity: 85% or less

Dimensions (W x H x D): Approx. 32.5 x 12.5 x 48.5 mm / 1.3 x 0.49 x 1.9 in.

Weight: Approx. 35 g / 1.2 oz.

• **Battery Charger LC-E12**

Compatible battery:	Battery Pack LP-E12
Recharging time:	Approx. 2 hours (at 23°C/73°F)
Rated input:	100 - 240 V AC (50/60 Hz)
Rated output:	8.4 V DC / 540 mA
Working temperature range:	5°C - 40°C / 41°F - 104°F
Working humidity:	85% or less
Dimensions (W x H x D):	Approx. 65 x 25.5 x 90 mm / 2.6 x 1.0 x 3.5 in.
Weight:	Approx. 81 g / 2.9 oz.

• **Battery Charger LC-E12E**

Compatible battery:	Battery Pack LP-E12
Recharging time:	Approx. 2 hours (at 23°C/73°F)
Rated input:	100 - 240 V AC (50/60 Hz)
Rated output:	8.4 V DC / 540 mA
Working temperature range:	5°C - 40°C / 41°F - 104°F
Working humidity:	85% or less
Dimensions (W x H x D):	Approx. 65 x 25.5 x 90 mm / 2.6 x 1.0 x 3.5 in. (excluding power cord)
Weight:	Approx. 76 g / 2.7 oz. (excluding power cord)

- All the data above is based on Canon's testing standards and CIPA (Camera & Imaging Products Association) testing standards and guidelines.
- Dimensions, maximum diameter, length and weight listed above are based on CIPA Guidelines (except weight for camera body only).
- Product specifications and the exterior are subject to change without notice.
- If a problem occurs with a non-Canon lens attached to the camera, consult the respective lens maker.

Trademarks

- Adobe is a trademark of Adobe Systems Incorporated.
- Windows is a trademark or registered trademark of Microsoft Corporation in the United States and other countries.
- Macintosh and Mac OS are trademarks or registered trademarks of Apple Inc. in the United States and other countries.
- SDXC logo is a trademark of SD-3C, LLC.
- HDMI, HDMI logo, and High-Definition Multimedia Interface are trademarks or registered trademarks of HDMI Licensing LLC.
- All other corporate and product names and trademarks mentioned in this manual are the property of their respective owners.

About MPEG-4 Licensing

"This product is licensed under AT&T patents for the MPEG-4 standard and may be used for encoding MPEG-4 compliant video and/or decoding MPEG-4 compliant video that was encoded only (1) for a personal and non-commercial purpose or (2) by a video provider licensed under the AT&T patents to provide MPEG-4 compliant video. No license is granted or implied for any other use for MPEG-4 standard."

* Notice displayed in English as required.

Use of genuine Canon accessories is recommended

This product is designed to achieve excellent performance when used with genuine Canon accessories. Canon shall not be liable for any damage to this product and/or accidents such as fire, etc., caused by the malfunction of non-genuine Canon accessories (e.g., a leakage and/or explosion of a battery pack). Please note that this warranty does not apply to repairs arising out of the malfunction of non-genuine Canon accessories, although you may request such repairs on a chargeable basis.

Safety Warnings

Follow these safeguards and use the equipment properly to prevent injury, death, and material damage.

Preventing Serious Injury or Death

- To prevent fire, excessive heat, chemical leakage, and explosions, follow the safeguards below:
 - Do not use any batteries, power sources, and accessories not specified in this booklet. Do not use any home-made or modified batteries.
 - Do not short-circuit, disassemble, or modify the battery pack or back-up battery. Do not apply heat or apply solder to the battery pack or back-up battery. Do not expose the battery pack or back-up battery to fire or water. And do not subject the battery pack or back-up battery to strong physical shock.
 - Do not install the battery pack or back-up battery in reversed polarity (+ -). Do not mix new and old or different types of batteries.
 - Do not recharge the battery pack outside the allowable ambient temperature range of 0°C - 40°C (32°F - 104°F). Also, do not exceed the recharging time.
 - Do not insert any foreign metallic objects into the electrical contacts of the camera, accessories, connecting cables, etc.
- Keep the back-up battery away from children. If a child swallows the battery, consult a physician immediately. (Battery chemicals may harm the stomach and intestines.)
- When disposing of a battery pack or back-up battery, insulate the electrical contacts with tape to prevent contact with other metallic objects or batteries. This is to prevent fire or an explosion.
- If excessive heat, smoke, or fumes are emitted during battery pack recharging, immediately unplug the battery charger from the power outlet to stop the recharging and prevent a fire.
- If the battery pack or back-up battery leaks, changes color, deforms, or emits smoke or fumes, remove it immediately. Be careful not to get burned in the process.
- Prevent any battery leakage from contacting your eyes, skin, and clothing. It can cause blindness or skin problems. If the battery leakage contacts your eyes, skin, or clothing, flush the affected area with lots of clean water without rubbing it. See a physician immediately.
- During the recharging, keep the equipment away from the reach of children. The cord can accidentally choke the child or give an electrical shock.
- Do not leave any cords near a heat source. It can deform the cord or melt the insulation and cause a fire or electrical shock.
- Do not fire the flash at someone driving a car. It may cause an accident.
- Do not fire the flash near a person's eyes. It may impair the person's vision. When using flash to photograph an infant, keep at least 1 meter away.
- Before storing the camera or accessory when not in use, remove the battery pack and disconnect the power plug. This is to prevent electrical shock, heat generation, and fire.
- Do not use the equipment where there is flammable gas. This is to prevent an explosion or fire.

-
- If you drop the equipment and the casing breaks open to expose the internal parts, do not touch the internal parts due to the possibility of electrical shock.
 - Do not disassemble or modify the equipment. High-voltage internal parts can cause electrical shock.
 - Do not look at the sun or an extremely bright light source through the camera or lens. Doing so may damage your vision.
 - Keep the camera from the reach of small children. The neck strap can accidentally choke the child.
 - Do not store the equipment in dusty or humid places. This is to prevent fire and electrical shock.
 - Before using the camera inside an airplane or hospital, check if it is allowed. Electromagnetic waves emitted by the camera may interfere with the plane's instruments or the hospital's medical equipment.
 - To prevent fire and electrical shock, follow the safeguards below:
 - Always insert the power plug all the way in.
 - Do not handle a power plug with wet hands.
 - When unplugging a power plug, grasp and pull the plug instead of the cord.
 - Do not scratch, cut, or excessively bend the cord or put a heavy object on the cord. Also do not twist or tie the cords.
 - Do not connect too many power plugs to the same power outlet.
 - Do not use a cord whose insulation has been damaged.
 - Occasionally unplug the power plug and use a dry cloth to clean off the dust around the power outlet. If the surrounding is dusty, humid, or oily, the dust on the power outlet may become moist and short-circuit the outlet to cause a fire.
-

Preventing Injury or Equipment Damage

-
- Do not leave equipment inside a car under the hot sun or near a heat source. The equipment may become hot and cause skin burns.
 - Do not carry the camera around while it is attached to a tripod. Doing so may cause injury. Also make sure the tripod is sturdy enough to support the camera and lens.
 - Do not leave a lens or lens-attached camera under the sun without the lens cap attached. Otherwise, the lens may concentrate the sun's rays and cause a fire.
 - Do not cover or wrap the battery-recharging apparatus with a cloth. Doing so may trap heat within and cause the casing to deform or catch fire.
 - If you drop the camera in water or if water or metal fragments enter inside the camera, promptly remove the battery pack and back-up battery. This is to prevent fire and electrical shock.
 - Do not use or leave the battery pack or back-up battery in a hot environment. Doing so may cause battery leakage or a shorter battery life. The battery pack or back-up battery can also become hot and cause skin burns.
 - Do not use paint thinner, benzene, or other organic solvents to clean the equipment. Doing so may cause fire or a health hazard.
-

If the product does not work properly or requires repair, contact your dealer or your nearest Canon Service Center.



European Union (and EEA) only.

These symbols indicate that this product is not to be disposed of with your household waste, according to the WEEE Directive (2002/96/EC), the Battery Directive (2006/66/EC) and/or your national laws implementing those Directives.



If a chemical symbol is printed beneath the symbol shown above, in accordance with the Battery Directive,

this indicates that a heavy metal (Hg = Mercury, Cd = Cadmium, Pb = Lead) is present in this battery or accumulator at a concentration above an applicable threshold specified in the Battery Directive.

This product should be handed over to a designated collection point, e.g., on an authorized one-for-one basis when you buy a new similar product or to an authorized collection site for recycling waste electrical and electronic equipment (EEE) and batteries and accumulators. Improper handling of this type of waste could have a possible impact on the environment and human health due to potentially hazardous substances that are generally associated with EEE.

Your cooperation in the correct disposal of this product will contribute to the effective usage of natural resources.

For more information about the recycling of this product, please contact your local city office, waste authority, approved scheme or your household waste disposal service or visit

www.canon-europe.com/environment.

(EEA: Norway, Iceland and Liechtenstein)

IMPORTANT SAFETY INSTRUCTIONS

1. **SAVE THESE INSTRUCTIONS** — This manual contains important safety and operating instructions for Battery Charger LC-E12 & LC-E12E.
2. Before using the charger, read all instructions and cautionary remarks on (1) the charger, (2) the battery pack, and (3) the product using the battery pack.
3. **CAUTION** — To reduce risk of injury, charge only the Battery Pack LP-E12. Other types of batteries may burst, causing personal injury and other damage.
4. Do not expose the charger to rain or snow.
5. Use of an attachment not recommended or sold by Canon may result in fire, electric shock, or personal injury.
6. To reduce risk of damage to electric plug and cord, pull by plug rather than by cord when disconnecting charger.
7. Make sure cord is located so that it will not be stepped on, tripped over, or otherwise subjected to damage or stress.
8. Do not operate the charger with damaged cord or plug - replace them immediately.
9. Do not operate the charger if it has received a sharp blow, been dropped, or otherwise damaged in any way; take it to a qualified serviceman.
10. Do not disassemble the charger; take it to a qualified serviceman when service or repair is required. Incorrect reassembly may result in a risk of electric shock or fire.
11. To reduce risk of electric shock, unplug charger from outlet before attempting any maintenance or cleaning.

MAINTENANCE INSTRUCTION

Unless otherwise stated in this manual, there are no user serviceable parts inside. Refer servicing to qualified serviceman.

CAUTION

RISK OF EXPLOSION IF BATTERY IS REPLACED BY AN INCORRECT TYPE.
DISPOSE OF USED BATTERIES ACCORDING TO LOCAL REGULATION.



Transferring images to your PC or Mac computer not only keeps them safe, but also allows you to print and edit them using the software supplied with your EOS M.

12

Downloading Images to a Personal Computer and Index

This chapter explains how to download images from the camera to your personal computer, gives an overview of the software on the EOS Solution Disk (CD-ROM) provided with the camera, and explains how to install the software on your personal computer. It also explains how to view the PDF files on the EOS Camera Instruction Manuals Disk (DVD-ROM).

Before installing the software, check that your personal computer's operating system is compatible.



EOS Solution Disk
(Software)



**EOS Camera Instruction
Manuals Disk**

Downloading Images to a Personal Computer

You can use the provided software to download the images in the camera to your personal computer. There are two ways to do this.

Download by Connecting the Camera to the Personal Computer

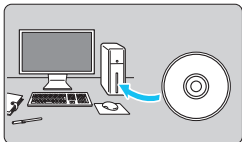

1 Install the software (p.341).

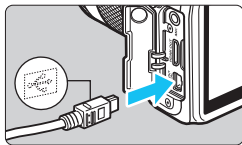

2 Use the provided interface cable to connect the camera to your personal computer.

- Use the interface cable provided with the camera.
- Connect the cable to the camera's <DIGITAL> terminal with the cable plug's <↔> icon facing the front of the camera.
- Connect the cord's plug to the personal computer's USB terminal.

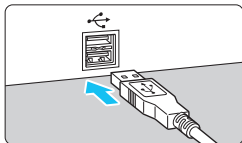

3 Use EOS Utility to download the images/movies.

- For details, refer to the PDF Software Instruction Manual on the DVD-ROM (p.343).

Downloading Images with a Card Reader

If you have a commercially-available card reader, you can use it to download images to your personal computer.

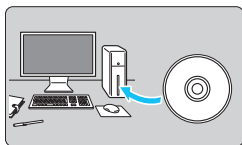

1 Install the software (p.341).

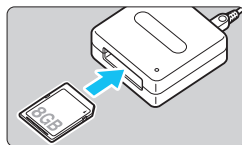

2 Insert the card into the card reader.

3 Use Canon software to download the images/movies.

- ▶ Use Digital Photo Professional.
- ▶ Use ImageBrowser EX.
- For details, refer to the PDF Software Instruction Manual on the DVD-ROM (p.343).



When downloading images from the camera to your personal computer, if you do not use Canon software and instead use a card reader, copy the DCIM folder on the card to your personal computer.



EOS Solution Disk

This disk contains various software applications for EOS cameras.

1 EOS Utility

Communication Software for the Camera and Computer

- You can download images (still images/movies) you have shot with the camera to your computer.
- You can set the various settings of the camera from your computer.
- You can shoot photos remotely by connecting the camera to your computer.
- You can copy background music tracks to the card, and play the background music during playback.

2 Digital Photo Professional

Image Viewing and Editing Software

- You can view, edit and print shot images on your computer at high-speed.
- You can edit images with originals remaining unchanged.
- Can be used by a wide range of users from amateurs to professionals. It is especially recommended for users who mainly shoot RAW images.

3 ImageBrowser EX

Image Viewing and Editing Software

- You can view, browse and print JPEG images on your computer.
- You can play movies (MOV files), video snapshot albums, and extract still photos from movies.
- You can download additional functions, such as EOS Video Snapshot Task (p.196), with an internet connection.
- Recommended for novices who are using a digital camera for the first time and amateur users.

! Note that the software ZoomBrowser EX/ImageBrowser provided with previous cameras does not support still photos and movie files shot with this camera (it is not compatible). Use ImageBrowser EX provided with this camera.

4 Picture Style Editor

Picture Style File Creating Software

- This software is aimed at advanced users who are experienced in processing images.
- You can edit Picture Style to your unique image characteristics and create/save an original Picture Style file.

Installing the Software on Macintosh

Compatible OS **MAC OS X 10.6 - 10.7**

- 1 Check that the camera is not connected to your computer.
- 2 Insert the EOS Solution Disk (CD).
 - On your computer's desktop, double-click and open the CD-ROM icon, and then double-click [Canon EOS Digital Installer].
- 3 Select your geographic area, country and language.
- 4 Click **[Easy Installation]** to start installation.



- Follow the on-screen instructions to complete the installation procedure.
- 5 Click **[Restart]** when the installation has completed.

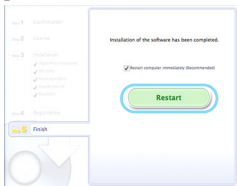

- 6 Once the computer has restarted, remove the CD.

[WINDOWS]



EOS Camera Instruction Manuals Disk

Copy the PDF Instruction Manuals contained on the disk to your computer.

- 1 Insert the EOS Camera Instruction Manuals Disk (DVD) into the DVD-ROM drive of your computer.
- 2 Open the disk.
 - Double-click **[My Computer]** on the desktop and then double-click the DVD-ROM drive into which you have inserted the disk. Select your language and operating system. The index of the Instruction Manuals is displayed.



Adobe Reader (latest version recommended) must be installed to view the Instruction Manual files (PDF format). Install Adobe Reader if it is not already installed on your computer.
To save the PDF manual to your computer, use the 'Save' function of your Adobe Reader.

[MACINTOSH]



EOS Camera Instruction Manuals Disk

Copy the PDF Instruction Manuals contained on the disk to your Macintosh.

- 1 Insert the EOS Camera Instruction Manuals Disk (DVD) into the DVD-ROM drive of your Macintosh.
- 2 Open the disk.
 - Double-click on the disk icon.
- 3 Double-click the START.html file.
Select your language and operating system. The index of the Instruction Manuals is displayed.



Adobe Reader (latest version recommended) must be installed to view the Instruction Manual files (PDF format). Install Adobe Reader if it is not already installed on your Macintosh.
To save the PDF manual to your computer, use the 'Save' function of your Adobe Reader.

Index

- Numerics**
- 10-sec. or 2-sec. delay 136
 - 1280x720 187
 - 1920x1080 187
 - 4- or 9-image index display..... 231
 - 640x480 187
- A**
- A+** (Scene Intelligent Auto)..... 66
 - AC Adapter Kit 290
 - Access lamp 23
 - Accessories 3
 - Adobe RGB..... 176
 - AE lock..... 157
 - AEB..... 155, 284
 - AF → Focusing
 - Ambience-based shots 82, 89, 94
 - Aperture-priority AE 144
 - Art bold effect..... 96
 - Aspect ratio 108
 - Audio/video OUT 251
 - Auto Lighting Optimizer 65, 159
 - Auto playback 243
 - Auto reset 211
 - Autofocus 130
 - Automatic selection (AF)..... 116, 130
 - Av (Aperture-priority AE)..... 144
 - A/V OUT 237, 251
- B**
- B/W (Monochrome)..... 115, 169
 - Basic Zone modes 26
 - Battery 32, 39
 - Battery check 39
 - Beeper 204
 - BGM 246
 - Black-and-white image... 89, 115, 169
 - Bracketing 155, 175
 - Brightness (exposure)..... 153
 - Auto exposure bracketing (AEB) 155, 284
 - Autoexposure lock (AE lock).... 157
 - Exposure compensation 153
 - Measurement method (Metering mode) 151
 - BULB (Bulb exposure) 150
 - Bulb exposures 150
- C**
- CA** (Creative Auto)..... 75
 - Cable 3, 247, 266, 298
 - Camera
 - Clear camera settings 216
 - Holding the camera..... 48
 - Settings display..... 215
 - Camera shake 46, 48
 - Card 18, 34, 57
 - Card reminder..... 204
 - Format 57
 - Low-level format 58
 - Problem 36, 58
 - SD speed class..... 177
 - Write-protect 34
 - Center-weighted average metering 152
 - Charger 29, 32
 - Chromatic aberration correction... 164
 - Cleaning (Image sensor)..... 225
 - Clear camera settings 216
 - Close-ups 80
 - Color space (color reproduction range)..... 176
 - Color temperature 174

Color tone	168
Continuous.....	210
Continuous shooting.....	133
Contrast	168
Copyright information.....	212
Creative Auto	75
Creative filters.....	94, 260
☆ icon.....	4
Creative Zone modes.....	25
Custom Functions.....	282
Custom WB.....	172

D

Date/File number imprinting	271, 275
Date/Time	41
Daylight saving time.....	42
DC coupler.....	290
Depth-of-field preview.....	147
Digital terminal.....	251, 266, 338
Direct printing.....	278
DPOF.....	275
Dragging	62
Drive mode.....	24, 77, 133, 136
Dust Delete Data.....	227

E

Erase (image)	254
Error codes	323
Evaluative metering	151
Exposure compensation	153
Exposure level increments.....	284
Extension	211
External flash	138, 292
Eye-Fi card.....	294









F

Faithful.....	115
FE lock	292
Feature guide	60
FEB	222
File name.....	210
File size	105, 188, 256
Fill-in flash	140
Filter effect.....	94, 169, 260
Final image simulation.....	73, 184
Fine (Image-recording quality)	105
Firmware Ver.	305
First-curtain synchronization	223
Fish-eye effect.....	96
Flash	
Custom Functions	224
Effective range	139
External flash	138, 292
Flash control	220
Flash exposure compensation.....	154
Flash off	77, 88
Flash-sync speed.....	293
Manual flash.....	223
Shutter synchronization (1st/2nd curtain).....	223
Wireless	223
Flash exposure compensation	154
Flash mode.....	222, 223
Flash-sync contacts.....	22
Focus lock	71
Focus mode switch.....	28, 117, 126
Focusing	
AF method	116
AF operation	130
AF-assist beam	132, 286
Beeper	204
Difficult-to-focus subjects	123

- Manual focusing 126
- Out of focus 46, 48, 123
- Recompose 71
- Folder Create/Select 208
- Format (card initialization) 57
- Frame rate 187
- Full Auto (Scene Intelligent Auto) ... 66
- Full High-Definition
(Full HD) 187, 237
- G**
- Grainy B/W 96
- Grid display 205
- H**
- Handheld Night Scene 85
- HDMI 237, 247
- HDMI CEC 249
- HDR Backlight Control 86
- High ISO speed noise reduction ... 160
- High-Definition (HD) 187, 237
- Highlight alert 258
- Highlight detail loss 258
- Highlight tone priority 285
- Histogram (Brightness/RGB) 258
- Hot shoe 292
- Household power 290
- I**
- ICC profile 176
- Image
 - Auto playback 243
 - Auto rotate 214
 - Erase 254
 - Highlight alert 258
 - Histogram 258
 - Image characteristics
(Picture Style) 114, 166, 170
 - Index 231
 - Jump display
(Image browsing) 232
 - Magnified view 231
 - Manual rotate 233
 - Number 210
 - Playback 98, 229
 - Protect 252
 - Rating 234
 - Review time 205
 - Shooting information 256
 - Slide show 243
 - Transfer 294
 - View on TV 237, 247
- Image area 45
- Image dust prevention 225, 227
- Image review 205
- Image Stabilizer (lens) 46
- Image-recording quality 105
- Index display 231
- ISO speed 109
 - Automatic setting (Auto) 112
 - ISO expansion 284
 - Maximum ISO speed with
ISO Auto 113
- J**
- JPEG 105
- Jump display 232
- L**
- Landscape 79, 115
- Language selection 43
- Large (Image-recording quality) ... 105
- LCD monitor 18
 - Brightness adjustment 207
 - Image playback 98, 229
 - LCD monitor off 38, 206
 - Menu screen 54, 300
 - Screen color 219

- Shooting settings display24
- Lens27, 44
 - Chromatic aberration correction 164
 - Image Stabilizer46
 - Lock release45
 - Peripheral illumination correction 163
- Light/scene-based shots92
- Live View shooting
 - Aspect ratio 108
 - Continuous AF 116, 124
 - Face+Tracking 118
 - FlexiZone - Multi 120
 - FlexiZone - Single 121
 - Information display70
 - Manual focusing 126
 - Possible shots 39, 105
 - Quick Control50, 88, 104, 186
- Long exposure noise reduction 161
- Long exposures 150
- M**
- M (Manual exposure) 148
- Macro photography80
- Magnified view 126, 231
- Main Dial23, 64, 141
- Malfunction311
- Manual exposure 148, 180
- Manual focus (MF) 126
- Manual focusing 126
- Manual reset211
- Maximum burst 106
- Medium
 - (Image-recording quality) 105, 263
- Memory card → Card
- Menu
 - My Menu 288
 - Setting procedure 56
 - Settings 300
 - MENU** icon 4
 - Metering mode 151
 - MF (Manual focusing) 126
 - Microphone 178
 - Miniature effect 97
 - Mode Dial 25
 - Monochrome 89, 115, 169
 - Movie 177
 - AF method 186
 - Attenuator 198
 - Autoexposure 178
 - Edit 241
 - Editing out first and last scenes 241
 - Enjoying 237
 - File size 188
 - Frame rate 187
 - Information display 182
 - Manual exposure 180
 - Manual focusing 178
 - Movie recording size 187
 - Movie Servo AF 199
 - Playback 239
 - Quick Control 186
 - Recording time 188
 - Sound recording 197
 - Still photo shooting 184
 - Video snapshot 189
 - Video snapshot album 189
 - View on TV 237, 247
 - Wind Filter 198
 - Multi Shot Noise Reduction 160
 - My Menu 288
- N**
- Neutral 115

- Night Portrait..... 83
 - Night scene..... 83, 85
 - Noise reduction
 - High ISO speed..... 160
 - Long exposures..... 161
 - Nomenclature 22
 - Non-Canon flash units 293
 - Normal
(Image-recording quality)..... 105
 - NTSC..... 187, 304, 309
- O**
- ONE SHOT (One-Shot AF)..... 131
 - One-Shot AF..... 131
- P**
- P (Program AE) 102
 - PAL 187, 304, 309
 - Paper settings (printing)..... 268
 - Partial metering..... 151
 - Peripheral illumination
correction 163
 - Photobook Set-up 279
 - PictBridge 265
 - Picture Style..... 114, 166, 170
 - Pixels 105
 - Playback 98, 229
 - Portrait 78, 83, 115
 - Possible shots..... 39, 105
 - Power
 - Battery check..... 39
 - Camera auto off..... 206
 - Household power 290
 - Possible shots 39, 105
 - Recharge..... 32
 - Pressing completely..... 49
 - Pressing halfway 49
 - Printing 265
 - Layout..... 269
 - Paper settings..... 268
 - Photobook Set-up 279
 - Print Order (DPOF)..... 275
 - Printing effects 270
 - Tilt correction 273
 - Trimming..... 273
 - Program AE..... 102
 - Program shift..... 103
 - Protect
(image erase-protection) 252
- Q**
- Q** (Quick
Control) 50, 88, 104, 186, 236
 - Quick Control ... 50, 88, 104, 186, 236
- R**
- Rating mark..... 234
 - RAW 105, 107
 - RAW+JPEG 105, 107
 - Recharge..... 32
 - Release shutter without card..... 204
 - Remote control shooting 291
 - Resize 262
 - Revert to default settings 216
 - Rotate (image) 214, 233, 273
- S**
- Safety warnings..... 333
 - Saturation 168
 - Scene icon 72
 - SD, SDHC, SDXC card → Card
 - Second-curtain synchronization ... 223
 - Self-timer..... 136
 - Sensor cleaning 225

- Sepia (Monochrome) 89, 169
 Servo AF 131
 Sharpness 168
 Shooting information display 256
 Shooting mode 25
 Av (Aperture-priority AE) 144
 M (Manual exposure) 148
 P (Program AE) 102
 Tv (Shutter-priority AE) 142
  (Scene Intelligent Auto) 66
  (Creative Auto) 75
  (Portrait) 78
  (Landscape) 79
  (Close-up) 80
  (Sports) 81
  (Night Portrait) 83
  (Handheld Night Scene) 85
  (HDR Backlight Control) 86
 Shooting mode's available functions 296
 Shooting settings display 24
 Shutter button 49
 Shutter synchronization 223
 Shutter-priority AE 142
 Single shooting 77, 297
 Single-image display 98
 Single-point AF 121
 Slide show 243
 Small
 (Image-recording quality) 105, 263
 Soft focus 96
 Software 3, 340
 Speaker 239
 Sports 81
 Spot metering 151
 sRGB 176
 Stopped-down aperture 147
 System map 298
T
 Tap (Touch) 61
 Temperature warning 128, 201
 Tone priority 285
 Toning effect (Monochrome) 169
 Touch beeping 63
 Touch screen 23, 61, 230, 240
 Touch shutter 125
 Toy camera effect 97
 Trimming (printing) 273
 Tripod socket 23
 Tv (Shutter-priority AE) 142
U
 USB (Digital) terminal ... 251, 266, 338
V
 Video snapshot 189
 Video snapshot album 189
 Video system 187, 251, 304, 309
 View on TV 237, 247
 Volume (Movie playback) 240
W
 Water painting effect 96
 WB (White balance) 172
 White balance 172
 Bracketing 175
 Correction 174
 Custom 172
 Wind Filter 198
 Wireless flash shooting 223
Z
 Zone 40



CANON INC.

30-2 Shimomaruko 3-chome, Ohta-ku, Tokyo 146-8501, Japan

Europe, Africa & Middle East

CANON EUROPA N.V.

PO Box 2262, 1180 EG Amstelveen, The Netherlands

For your local Canon office, please refer to your warranty card or to www.canon-europe.com/Support

The product and associated warranty are provided in European countries by Canon Europa N.V.

The lenses and accessories mentioned in this Instruction Manual are current as of July 2012. For information on the camera's compatibility with any lenses and accessories introduced after this date, contact any Canon Service Center.